



**THE DATASHEET OF  
LM4128BMF-3.0**



# LM4128/LM4128Q

## SOT-23 Precision Micropower Series Voltage Reference

### General Description

Ideal for space critical applications, the LM4128 precision voltage reference is available in the SOT-23 surface-mount package. The LM4128's advanced design eliminates the need for an external stabilizing capacitor while ensuring stability with capacitive loads up to 10  $\mu\text{F}$ , thus making the LM4128 easy to use.

Series references provide lower power consumption than shunt references, since they do not have to idle the maximum possible load current under no load conditions. This advantage, the low quiescent current (60  $\mu\text{A}$ ), and the low dropout voltage (400 mV) make the LM4128 ideal for battery-powered solutions.

The LM4128 is available in four grades (A, B, C, and D) for greater flexibility. The best grade devices (A) have an initial accuracy of 0.1% with guaranteed temperature coefficient of 75 ppm/ $^{\circ}\text{C}$  or less, while the lowest grade parts (D) have an initial accuracy of 1.0% and a tempco of 100 ppm/ $^{\circ}\text{C}$ .

### Features

- Output voltage initial accuracy 0.1%
- Low temperature coefficient 75 ppm/ $^{\circ}\text{C}$
- Low Supply Current, 60  $\mu\text{A}$
- Enable pin allowing a 3  $\mu\text{A}$  shutdown mode
- Up to 20 mA output current
- Voltage options 1.8V, 2.048V, 2.5V, 3.0V, 3.3V, 4.096V
- Custom voltage options available (1.8V to 4.096V)
- $V_{\text{IN}}$  range of  $V_{\text{REF}} + 400 \text{ mV}$  to 5.5V @ 10 mA
- Stable with low ESR ceramic capacitors
- SOT23-5 Package
- $-40^{\circ}\text{C}$  to  $125^{\circ}\text{C}$  junction temperature range
- LM4128AQ/BQ/CQ/DQ are AEC-Q100 Grade 1 qualified and are manufactured on an Automotive Grade Flow

### Applications

- Instrumentation & Process Control
- Test Equipment
- Data Acquisition Systems
- Base Stations
- Servo Systems
- Portable, Battery Powered Equipment
- Automotive & Industrial Electronics
- Precision Regulators
- Battery Chargers
- Communications
- Medical Equipment

### Typical Application Circuit

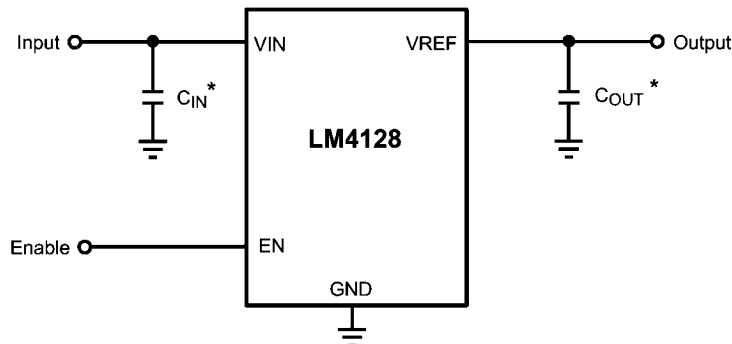

\*Note: The capacitor  $C_{\text{IN}}$  is required and the capacitor  $C_{\text{OUT}}$  is optional.

20211001

## Connection Diagram

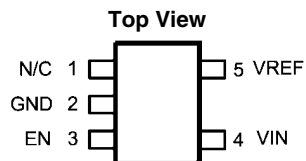

20211002  
**SOT23-5 Package**  
**NS Package Number MF05A**

## Ordering Information

| Input Output Voltage Accuracy at 25°C And Temperature Coefficient | LM4128 Supplied as 1000 units, Tape and Reel | LM4128 Supplied as 3000 units, Tape and Reel | Part Marking | Feature |
|---|--|--|--------------|---------|
| 0.1%, 75 ppm/°C (A grade)   | LM4128AMF-1.8                                | LM4128AMFX-1.8                               | R5AA         |         |
|   | LM4128AMF-2.0                                | LM4128AMFX-2.0                               | R5BA         |         |
|   | LM4128AMF-2.5                                | LM4128AMFX-2.5                               | R5CA         |         |
|   | LM4128AMF-3.0                                | LM4128AMFX-3.0                               | R5DA         |         |
|   | LM4128AMF-3.3                                | LM4128AMFX-3.3                               | R5EA         |         |
|   | LM4128AMF-4.1                                | LM4128AMFX-4.1                               | R5FA         |         |
| 0.2%, 75 ppm/°C (B grade)   | LM4128BMF-1.8                                | LM4128BMFX-1.8                               | R5AB         |         |
|   | LM4128BMF-2.0                                | LM4128BMFX-2.0                               | R5BB         |         |
|   | LM4128BMF-2.5                                | LM4128BMFX-2.5                               | R5CB         |         |
|   | LM4128BMF-3.0                                | LM4128BMFX-3.0                               | R5DB         |         |
|   | LM4128BMF-3.3                                | LM4128BMFX-3.3                               | R5EB         |         |
|   | LM4128BMF-4.1                                | LM4128BMFX-4.1                               | R5FB         |         |
| 0.5%, 100 ppm/°C (C grade)  | LM4128CMF-1.8                                | LM4128CMFX-1.8                               | R5AC         |         |
|   | LM4128CMF-2.0                                | LM4128CMFX-2.0                               | R5BC         |         |
|   | LM4128CMF-2.5                                | LM4128CMFX-2.5                               | R5CC         |         |
|   | LM4128CMF-3.0                                | LM4128CMFX-3.0                               | R5DC         |         |
|   | LM4128CMF-3.3                                | LM4128CMFX-3.3                               | R5EC         |         |
|   | LM4128CMF-4.1                                | LM4128CMFX-4.1                               | R5FC         |         |
| 1.0%, 100 ppm/°C max (D grade)                                    | LM4128DMF-1.8                                | LM4128DMFX-1.8                               | R5AD         |         |
|   | LM4128DMF-2.0                                | LM4128DMFX-2.0                               | R5BD         |         |
|   | LM4128DMF-2.5                                | LM4128DMFX-2.5                               | R5CD         |         |
|   | LM4128DMF-3.0                                | LM4128DMFX-3.0                               | R5DD         |         |
|   | LM4128DMF-3.3                                | LM4128DMFX-3.3                               | R5ED         |         |
|   | LM4128DMF-4.1                                | LM4128DMFX-4.1                               | R5FD         |         |

| Input Output Voltage Accuracy at 25°C And Temperature Coefficient | LM4128 Supplied as 1000 units, Tape and Reel | LM4128 Supplied as 3000 units, Tape and Reel | Part Marking | Feature   |
|---|--|--|--------------|---|
| 0.1%, 75 ppm/°C (AQ grade)  | LM4128AQ1MF1.8                               | LM4128AQ1MFX1.8                              | R6AA         | AEC-Q100 Grade 1 qualified. Automotive Grade Production Flow* |
|   | LM4128AQ1MF2.0                               | LM4128AQ1MFX2.0                              | R6BA         |   |
|   | LM4128AQ1MF2.5                               | LM4128AQ1MFX2.5                              | R6CA         |   |
|   | LM4128AQ1MF3.0                               | LM4128AQ1MFX3.0                              | R6DA         |   |
|   | LM4128AQ1MF3.3                               | LM4128AQ1MFX3.3                              | R6EA         |   |
|   | LM4128AQ1MF4.1                               | LM4128AQ1MFX4.1                              | R6FA         |   |
| 0.2%, 75 ppm/°C (BQ grade)  | LM4128BQ1MF1.8                               | LM4128BQ1MFX1.8                              | R6AB         | AEC-Q100 Grade 1 qualified. Automotive Grade Production Flow* |
|   | LM4128BQ1MF2.0                               | LM4128BQ1MFX2.0                              | R6BB         |   |
|   | LM4128BQ1MF2.5                               | LM4128BQ1MFX2.5                              | R6CB         |   |
|   | LM4128BQ1MF3.0                               | LM4128BQ1MFX3.0                              | R6DB         |   |
|   | LM4128BQ1MF3.3                               | LM4128BQ1MFX3.3                              | R6EB         |   |
|   | LM4128BQ1MF4.1                               | LM4128BQ1MFX4.1                              | R6FB         |   |
| 0.5%, 100 ppm/°C (CQ grade)                                       | LM4128CQ1MF1.8                               | LM4128CQ1MFX1.8                              | R6AC         | AEC-Q100 Grade 1 qualified. Automotive Grade Production Flow* |
|   | LM4128CQ1MF2.0                               | LM4128CQ1MFX2.0                              | R6BC         |   |
|   | LM4128CQ1MF2.5                               | LM4128CQ1MFX2.5                              | R6CC         |   |
|   | LM4128CQ1MF3.0                               | LM4128CQ1MFX3.0                              | R6DC         |   |
|   | LM4128CQ1MF3.3                               | LM4128CQ1MFX3.3                              | R6EC         |   |
|   | LM4128CQ1MF4.1                               | LM4128CQ1MFX4.1                              | R6FC         |   |
| 1.0%, 100 ppm/°C max (DQ grade)                                   | LM4128DQ1MF1.8                               | LM4128DQ1MFX1.8                              | R6AD         | AEC-Q100 Grade 1 qualified. Automotive Grade Production Flow* |
|   | LM4128DQ1MF2.0                               | LM4128DQ1MFX2.0                              | R6BD         |   |
|   | LM4128DQ1MF2.5                               | LM4128DQ1MFX2.5                              | R6CD         |   |
|   | LM4128DQ1MF3.0                               | LM4128DQ1MFX3.0                              | R6DD         |   |
|   | LM4128DQ1MF3.3                               | LM4128DQ1MFX3.3                              | R6ED         |   |
|   | LM4128DQ1MF4.1                               | LM4128DQ1MFX4.1                              | R6FD         |   |

\*Automotive Grade (Q) product incorporates enhanced manufacturing and support processes for the automotive market, including defect detection methodologies. Reliability qualification is compliant with the requirements and temperature grades defined in the AEC-Q100 standard. Automotive grade products are identified with the letter Q. For more information go to <http://www.national.com/automotive>.

## Pin Descriptions

| Pin # | Name | Function                       |
|-------|------|--------------------------------|
| 1     | N/C  | No connect pin, leave floating |
| 2     | GND  | Ground                         |
| 3     | EN   | Enable pin                     |
| 4     | VIN  | Input supply                   |
| 5     | VREF | Reference output               |

**Absolute Maximum Ratings** (Note 1)

If Military/Aerospace specified devices are required, please contact the National Semiconductor Sales Office/Distributors for availability and specifications.

|   |  |
|---|--|
| Maximum Voltage on any input                            | -0.3 to 6V                                 |
| Output short circuit duration                           | Indefinite                                 |
| Power Dissipation ( $T_A = 25^\circ\text{C}$ ) (Note 2) | 350 mW                                     |
| Storage Temperature Range                               | $-65^\circ\text{C}$ to $150^\circ\text{C}$ |
| Lead Temperature (soldering, 10sec)                     | $260^\circ\text{C}$                        |

|   |                     |
|---|---------------------|
| Vapor Phase (60 sec)                            | $215^\circ\text{C}$ |
| Infrared (15sec)                                | $220^\circ\text{C}$ |
| ESD Susceptibility (Note 3)<br>Human Body Model | 2 kV                |

**Operating Ratings**

|                                      |   |
|--------------------------------------|---|
| Maximum Input Supply Voltage         | 5.5V  |
| Maximum Enable Input Voltage         | $V_{IN}$                                    |
| Maximum Load Current                 | 20mA  |
| Junction Temperature Range ( $T_J$ ) | $-40^\circ\text{C}$ to $+125^\circ\text{C}$ |

**Electrical Characteristics**

**LM4128-1.8 ( $V_{OUT} = 1.8\text{V}$ )** Limits in standard type are for  $T_J = 25^\circ\text{C}$  only, and limits in **boldface type** apply over the junction temperature ( $T_J$ ) range of  $-40^\circ\text{C}$  to  $+125^\circ\text{C}$  unless otherwise specified. Minimum and Maximum limits are guaranteed through test, design, or statistical correlation. Typical values represent the most likely parametric norm at  $T_J = 25^\circ\text{C}$ , and are provided for reference purposes only. Unless otherwise specified  $V_{IN} = 5\text{V}$  and  $I_{LOAD} = 0\text{A}$ .

| Symbol                                | Parameter                           | Conditions   | Min<br>(Note 4) | Typ<br>(Note 5) | Max<br>(Note 4) | Unit                   |
|---------------------------------------|-------------------------------------|--|-----------------|-----------------|-----------------|------------------------|
| $V_{REF}$                             | Output Voltage Initial Accuracy     |  |                 |                 |                 |                        |
|                                       | LM4128A-1.8                         | (A Grade - 0.1%)                                       | -0.1            |                 | +0.1            | %                      |
|                                       | LM4128B-1.8                         | (B Grade - 0.2%)                                       | -0.2            |                 | +0.2            |                        |
|                                       | LM4128C-1.8                         | (C Grade - 0.5%)                                       | -0.5            |                 | +0.5            |                        |
| LM4128D-1.8                           | (D Grade - 1.0%)                    | -1.0   |                 | +1.0            |                 |                        |
| $TCV_{REF} / ^\circ\text{C}$ (Note 6) | Temperature Coefficient             | LM4128A-1.8  |                 |                 | <b>75</b>       | ppm / $^\circ\text{C}$ |
|                                       |                                     | LM4128B-1.8  |                 |                 | <b>75</b>       |                        |
|                                       |                                     | LM4128C-1.8  |                 |                 | <b>100</b>      |                        |
|                                       |                                     | LM4128D-1.8  |                 |                 | <b>100</b>      |                        |
| $I_Q$                                 | Supply Current                      |  |                 | 60              | <b>100</b>      | $\mu\text{A}$          |
| $I_{Q\_SD}$                           | Supply Current in Shutdown          | EN = 0V  |                 | 3               | <b>7</b>        | $\mu\text{A}$          |
| $\Delta V_{REF} / \Delta V_{IN}$      | Line Regulation                     | $V_{REF} + 400\text{ mV} \leq V_{IN} \leq 5.5\text{V}$ |                 | 30              |                 | ppm / V                |
| $\Delta V_{REF} / \Delta I_{LOAD}$    | Load Regulation                     | $0\text{ mA} \leq I_{LOAD} \leq 20\text{ mA}$          |                 | 25              | <b>120</b>      | ppm / mA               |
| $\Delta V_{REF}$                      | Long Term Stability (Note 7)        | 1000 Hrs   |                 | 50              |                 | ppm                    |
|                                       | Thermal Hysteresis (Note 8)         | $-40^\circ\text{C} \leq T_J \leq +125^\circ\text{C}$   |                 | 75              |                 |                        |
| $V_{IN} - V_{REF}$                    | Dropout Voltage (Note 9)            | $I_{LOAD} = 10\text{ mA}$                              |                 | 200             | <b>400</b>      | mV                     |
| $V_N$                                 | Output Noise Voltage                | 0.1 Hz to 10 Hz  |                 | 170             |                 | $\mu\text{V}_{PP}$     |
| $I_{SC}$                              | Short Circuit Current               |  |                 |                 | <b>75</b>       | mA                     |
| $V_{IL}$                              | Enable Pin Maximum Low Input Level  |  |                 |                 | <b>35</b>       | %V                     |
| $V_{IH}$                              | Enable Pin Minimum High Input Level |  | <b>65</b>       |                 |                 | %V                     |

## Electrical Characteristics

**LM4128-2.0 ( $V_{OUT} = 2.048V$ )** Limits in standard type are for  $T_J = 25^\circ C$  only, and limits in **boldface type** apply over the junction temperature ( $T_J$ ) range of  $-40^\circ C$  to  $+125^\circ C$  unless otherwise specified. Minimum and Maximum limits are guaranteed through test, design, or statistical correlation. Typical values represent the most likely parametric norm at  $T_J = 25^\circ C$ , and are provided for reference purposes only. Unless otherwise specified  $V_{IN} = 5V$  and  $I_{LOAD} = 0A$ .

| Symbol                             | Parameter                           | Conditions                                      | Min<br>(Note 4) | Typ<br>(Note 5) | Max<br>(Note 4) | Unit             |
|------------------------------------|-------------------------------------|---|-----------------|-----------------|-----------------|------------------|
| $V_{REF}$                          | Output Voltage Initial Accuracy     |   |                 |                 |                 |                  |
|                                    | LM4128A-2.0                         | (A Grade - 0.1%)                                | -0.1            |                 | +0.1            | %                |
|                                    | LM4128B-2.0                         | (B Grade - 0.2%)                                | -0.2            |                 | +0.2            |                  |
|                                    | LM4128C-2.0                         | (C Grade - 0.5%)                                | -0.5            |                 | +0.5            |                  |
| LM4128D-2.0                        | (D Grade - 1.0%)                    | -1.0  |                 | +1.0            |                 |                  |
| $TCV_{REF} / ^\circ C$ (Note 6)    | Temperature Coefficient             | LM4128A-2.0                                     |                 |                 | <b>75</b>       | ppm / $^\circ C$ |
|                                    |                                     | LM4128B-2.0                                     |                 |                 | <b>75</b>       |                  |
|                                    |                                     | LM4128C-2.0                                     |                 |                 | <b>100</b>      |                  |
|                                    |                                     | LM4128D-2.0                                     |                 |                 | <b>100</b>      |                  |
| $I_Q$                              | Supply Current                      |   |                 | 60              | <b>100</b>      | $\mu A$          |
| $I_{Q\_SD}$                        | Supply Current in Shutdown          | EN = 0V   |                 | 3               | <b>7</b>        | $\mu A$          |
| $\Delta V_{REF} / \Delta V_{IN}$   | Line Regulation                     | $V_{REF} + 400\text{ mV} \leq V_{IN} \leq 5.5V$ |                 | 30              |                 | ppm / V          |
| $\Delta V_{REF} / \Delta I_{LOAD}$ | Load Regulation                     | $0\text{ mA} \leq I_{LOAD} \leq 20\text{ mA}$   |                 | 25              | <b>120</b>      | ppm / mA         |
| $\Delta V_{REF}$                   | Long Term Stability (Note 7)        | 1000 Hrs  |                 | 50              |                 | ppm              |
|                                    | Thermal Hysteresis (Note 8)         | $-40^\circ C \leq T_J \leq +125^\circ C$        |                 | 75              |                 |                  |
| $V_{IN} - V_{REF}$                 | Dropout Voltage (Note 9)            | $I_{LOAD} = 10\text{ mA}$                       |                 | 175             | <b>400</b>      | mV               |
| $V_N$                              | Output Noise Voltage                | 0.1 Hz to 10 Hz                                 |                 | 190             |                 | $\mu V_{PP}$     |
| $I_{SC}$                           | Short Circuit Current               |   |                 |                 | <b>75</b>       | mA               |
| $V_{IL}$                           | Enable Pin Maximum Low Input Level  |   |                 |                 | <b>35</b>       | %V               |
| $V_{IH}$                           | Enable Pin Minimum High Input Level |   | <b>65</b>       |                 |                 | %V               |

## Electrical Characteristics

**LM4128-2.5 ( $V_{OUT} = 2.5V$ )** Limits in standard type are for  $T_J = 25^\circ C$  only, and limits in **boldface type** apply over the junction temperature ( $T_J$ ) range of  $-40^\circ C$  to  $+125^\circ C$  unless otherwise specified. Minimum and Maximum limits are guaranteed through test, design, or statistical correlation. Typical values represent the most likely parametric norm at  $T_J = 25^\circ C$ , and are provided for reference purposes only. Unless otherwise specified  $V_{IN} = 5V$  and  $I_{LOAD} = 0A$ .

| Symbol                             | Parameter                           | Conditions                                      | Min<br>(Note 4) | Typ<br>(Note 5) | Max<br>(Note 4) | Unit             |
|------------------------------------|-------------------------------------|---|-----------------|-----------------|-----------------|------------------|
| $V_{REF}$                          | Output Voltage Initial Accuracy     |   |                 |                 |                 |                  |
|                                    | LM4128A-2.5                         | (A Grade - 0.1%)                                | -0.1            |                 | +0.1            | %                |
|                                    | LM4128B-2.5                         | (B Grade - 0.2%)                                | -0.2            |                 | +0.2            |                  |
|                                    | LM4128C-2.5                         | (C Grade - 0.5%)                                | -0.5            |                 | +0.5            |                  |
| LM4128D-2.5                        | (D Grade - 1.0%)                    | -1.0  |                 | +1.0            |                 |                  |
| $TCV_{REF} / ^\circ C$ (Note 6)    | Temperature Coefficient             | LM4128A-2.5                                     |                 |                 | <b>75</b>       | ppm / $^\circ C$ |
|                                    |                                     | LM4128B-2.5                                     |                 |                 | <b>75</b>       |                  |
|                                    |                                     | LM4128C-2.5                                     |                 |                 | <b>100</b>      |                  |
|                                    |                                     | LM4128D-2.5                                     |                 |                 | <b>100</b>      |                  |
| $I_Q$                              | Supply Current                      |   |                 | 60              | <b>100</b>      | $\mu A$          |
| $I_{Q\_SD}$                        | Supply Current in Shutdown          | EN = 0V   |                 | 3               | <b>7</b>        | $\mu A$          |
| $\Delta V_{REF} / \Delta V_{IN}$   | Line Regulation                     | $V_{REF} + 400\text{ mV} \leq V_{IN} \leq 5.5V$ |                 | 50              |                 | ppm / V          |
| $\Delta V_{REF} / \Delta I_{LOAD}$ | Load Regulation                     | $0\text{ mA} \leq I_{LOAD} \leq 20\text{ mA}$   |                 | 25              | <b>120</b>      | ppm / mA         |
| $\Delta V_{REF}$                   | Long Term Stability (Note 7)        | 1000 Hrs  |                 | 50              |                 | ppm              |
|                                    | Thermal Hysteresis (Note 8)         | $-40^\circ C \leq T_J \leq +125^\circ C$        |                 | 75              |                 |                  |
| $V_{IN} - V_{REF}$                 | Dropout Voltage (Note 9)            | $I_{LOAD} = 10\text{ mA}$                       |                 | 175             | <b>400</b>      | mV               |
| $V_N$                              | Output Noise Voltage                | 0.1 Hz to 10 Hz                                 |                 | 275             |                 | $\mu V_{PP}$     |
| $I_{SC}$                           | Short Circuit Current               |   |                 |                 | <b>75</b>       | mA               |
| $V_{IL}$                           | Enable Pin Maximum Low Input Level  |   |                 |                 | <b>35</b>       | %V               |
| $V_{IH}$                           | Enable Pin Minimum High Input Level |   | <b>65</b>       |                 |                 | %V               |

## Electrical Characteristics

### LM4128-3.0 ( $V_{OUT} = 3.0V$ )

Limits in standard type are for  $T_J = 25^\circ C$  only, and limits in **boldface type** apply over the junction temperature ( $T_J$ ) range of  $-40^\circ C$  to  $+125^\circ C$  unless otherwise specified. Minimum and Maximum limits are guaranteed through test, design, or statistical correlation. Typical values represent the most likely parametric norm at  $T_J = 25^\circ C$ , and are provided for reference purposes only. Unless otherwise specified  $V_{IN} = 5V$  and  $I_{LOAD} = 0A$ .

| Symbol                             | Parameter                           | Conditions                                      | Min<br>(Note 4) | Typ<br>(Note 5) | Max<br>(Note 4) | Unit             |
|------------------------------------|-------------------------------------|---|-----------------|-----------------|-----------------|------------------|
| $V_{REF}$                          | Output Voltage Initial Accuracy     |   |                 |                 |                 |                  |
|                                    | LM4128A-3.0                         | (A Grade - 0.1%)                                | -0.1            |                 | +0.1            | %                |
|                                    | LM4128B-3.0                         | (B Grade - 0.2%)                                | -0.2            |                 | +0.2            |                  |
|                                    | LM4128C-3.0                         | (C Grade - 0.5%)                                | -0.5            |                 | +0.5            |                  |
| LM4128D-3.0                        | (D Grade - 1.0%)                    | -1.0  |                 | +1.0            |                 |                  |
| $TCV_{REF} / ^\circ C$ (Note 6)    | Temperature Coefficient             | LM4128A-3.0                                     |                 |                 | <b>75</b>       | ppm / $^\circ C$ |
|                                    |                                     | LM4128B-3.0                                     |                 |                 | <b>75</b>       |                  |
|                                    |                                     | LM4128C-3.0                                     |                 |                 | <b>100</b>      |                  |
|                                    |                                     | LM4128D-3.0                                     |                 |                 | <b>100</b>      |                  |
| $I_Q$                              | Supply Current                      |   |                 | 60              | <b>100</b>      | $\mu A$          |
| $I_{Q\_SD}$                        | Supply Current in Shutdown          | EN = 0V   |                 | 3               | <b>7</b>        | $\mu A$          |
| $\Delta V_{REF} / \Delta V_{IN}$   | Line Regulation                     | $V_{REF} + 400\text{ mV} \leq V_{IN} \leq 5.5V$ |                 | 70              |                 | ppm / V          |
| $\Delta V_{REF} / \Delta I_{LOAD}$ | Load Regulation                     | $0\text{ mA} \leq I_{LOAD} \leq 20\text{ mA}$   |                 | 25              | <b>120</b>      | ppm / mA         |
| $\Delta V_{REF}$                   | Long Term Stability (Note 7)        | 1000 Hrs  |                 | 50              |                 | ppm              |
|                                    | Thermal Hysteresis (Note 8)         | $-40^\circ C \leq T_J \leq +125^\circ C$        |                 | 75              |                 |                  |
| $V_{IN} - V_{REF}$                 | Dropout Voltage (Note 9)            | $I_{LOAD} = 10\text{ mA}$                       |                 | 175             | <b>400</b>      | mV               |
| $V_N$                              | Output Noise Voltage                | 0.1 Hz to 10 Hz                                 |                 | 285             |                 | $\mu V_{PP}$     |
| $I_{SC}$                           | Short Circuit Current               |   |                 |                 | <b>75</b>       | mA               |
| $V_{IL}$                           | Enable Pin Maximum Low Input Level  |   |                 |                 | <b>35</b>       | %V               |
| $V_{IH}$                           | Enable Pin Minimum High Input Level |   | <b>65</b>       |                 |                 | %V               |

## Electrical Characteristics

**LM4128-3.3 ( $V_{OUT} = 3.3V$ )** Limits in standard type are for  $T_J = 25^\circ C$  only, and limits in **boldface type** apply over the junction temperature ( $T_J$ ) range of  $-40^\circ C$  to  $+125^\circ C$  unless otherwise specified. Minimum and Maximum limits are guaranteed through test, design, or statistical correlation. Typical values represent the most likely parametric norm at  $T_J = 25^\circ C$ , and are provided for reference purposes only. Unless otherwise specified  $V_{IN} = 5V$  and  $I_{LOAD} = 0A$ .

| Symbol                             | Parameter                           | Conditions                                      | Min<br>(Note 4) | Typ<br>(Note 5) | Max<br>(Note 4) | Unit             |
|------------------------------------|-------------------------------------|---|-----------------|-----------------|-----------------|------------------|
| $V_{REF}$                          | Output Voltage Initial Accuracy     |   |                 |                 |                 |                  |
|                                    | LM4128A-3.3                         | (A Grade - 0.1%)                                | -0.1            |                 | +0.1            | %                |
|                                    | LM4128B-3.3                         | (B Grade - 0.2%)                                | -0.2            |                 | +0.2            |                  |
|                                    | LM4128C-3.3                         | (C Grade - 0.5%)                                | -0.5            |                 | +0.5            |                  |
| LM4128D-3.3                        | (D Grade - 1.0%)                    | -1.0  |                 | +1.0            |                 |                  |
| $TCV_{REF} / ^\circ C$ (Note 6)    | Temperature Coefficient             | LM4128A-3.3                                     |                 |                 | <b>75</b>       | ppm / $^\circ C$ |
|                                    |                                     | LM4128B-3.3                                     |                 |                 | <b>75</b>       |                  |
|                                    |                                     | LM4128C-3.3                                     |                 |                 | <b>100</b>      |                  |
|                                    |                                     | LM4128D-3.3                                     |                 |                 | <b>100</b>      |                  |
| $I_Q$                              | Supply Current                      |   |                 | 60              | <b>100</b>      | $\mu A$          |
| $I_{Q\_SD}$                        | Supply Current in Shutdown          | EN = 0V   |                 | 3               | <b>7</b>        | $\mu A$          |
| $\Delta V_{REF} / \Delta V_{IN}$   | Line Regulation                     | $V_{REF} + 400\text{ mV} \leq V_{IN} \leq 5.5V$ |                 | 85              |                 | ppm / V          |
| $\Delta V_{REF} / \Delta I_{LOAD}$ | Load Regulation                     | $0\text{ mA} \leq I_{LOAD} \leq 20\text{ mA}$   |                 | 25              | <b>120</b>      | ppm / mA         |
| $\Delta V_{REF}$                   | Long Term Stability (Note 7)        | 1000 Hrs  |                 | 50              |                 | ppm              |
|                                    | Thermal Hysteresis (Note 8)         | $-40^\circ C \leq T_J \leq +125^\circ C$        |                 | 75              |                 |                  |
| $V_{IN} - V_{REF}$                 | Dropout Voltage (Note 9)            | $I_{LOAD} = 10\text{ mA}$                       |                 | 175             | <b>400</b>      | mV               |
| $V_N$                              | Output Noise Voltage                | 0.1 Hz to 10 Hz                                 |                 | 310             |                 | $\mu V_{PP}$     |
| $I_{SC}$                           | Short Circuit Current               |   |                 |                 | <b>75</b>       | mA               |
| $V_{IL}$                           | Enable Pin Maximum Low Input Level  |   |                 |                 | <b>35</b>       | %V               |
| $V_{IH}$                           | Enable Pin Minimum High Input Level |   | <b>65</b>       |                 |                 | %V               |

## Electrical Characteristics

### LM4128-4.1 ( $V_{OUT} = 4.096V$ )

Limits in standard type are for  $T_J = 25^\circ C$  only, and limits in **boldface type** apply over the junction temperature ( $T_J$ ) range of  $-40^\circ C$  to  $+125^\circ C$  unless otherwise specified. Minimum and Maximum limits are guaranteed through test, design, or statistical correlation. Typical values represent the most likely parametric norm at  $T_J = 25^\circ C$ , and are provided for reference purposes only. Unless otherwise specified  $V_{IN} = 5V$  and  $I_{LOAD} = 0A$ .

| Symbol                             | Parameter                           | Conditions                                      | Min<br>(Note 4) | Typ<br>(Note 5) | Max<br>(Note 4) | Unit             |
|------------------------------------|-------------------------------------|---|-----------------|-----------------|-----------------|------------------|
| $V_{REF}$                          | Output Voltage Initial Accuracy     |   |                 |                 |                 |                  |
|                                    | LM4128A-4.1                         | (A Grade - 0.1%)                                | -0.1            |                 | +0.1            | %                |
|                                    | LM4128B-4.1                         | (B Grade - 0.2%)                                | -0.2            |                 | +0.2            |                  |
|                                    | LM4128C-4.1                         | (C Grade - 0.5%)                                | -0.5            |                 | +0.5            |                  |
| LM4128D-4.1                        | (D Grade - 1.0%)                    | -1.0  |                 | +1.0            |                 |                  |
| $TCV_{REF} / ^\circ C$ (Note 6)    | Temperature Coefficient             | LM4128A-4.1                                     |                 |                 | <b>75</b>       | ppm / $^\circ C$ |
|                                    |                                     | LM4128B-4.1                                     |                 |                 | <b>75</b>       |                  |
|                                    |                                     | LM4128C-4.1                                     |                 |                 | <b>100</b>      |                  |
|                                    |                                     | LM4128D-4.1                                     |                 |                 | <b>100</b>      |                  |
| $I_Q$                              | Supply Current                      |   |                 | 60              | <b>100</b>      | $\mu A$          |
| $I_{Q\_SD}$                        | Supply Current in Shutdown          | EN = 0V   |                 | 3               | <b>7</b>        | $\mu A$          |
| $\Delta V_{REF} / \Delta V_{IN}$   | Line Regulation                     | $V_{REF} + 400\text{ mV} \leq V_{IN} \leq 5.5V$ |                 | 100             |                 | ppm / V          |
| $\Delta V_{REF} / \Delta I_{LOAD}$ | Load Regulation                     | $0\text{ mA} \leq I_{LOAD} \leq 20\text{ mA}$   |                 | 25              | <b>120</b>      | ppm / mA         |
| $\Delta V_{REF}$                   | Long Term Stability (Note 7)        | 1000 Hrs  |                 | 50              |                 | ppm              |
|                                    | Thermal Hysteresis (Note 8)         | $-40^\circ C \leq T_J \leq +125^\circ C$        |                 | 75              |                 |                  |
| $V_{IN} - V_{REF}$                 | Dropout Voltage (Note 9)            | $I_{LOAD} = 10\text{ mA}$                       |                 | 175             | <b>400</b>      | mV               |
| $V_N$                              | Output Noise Voltage                | 0.1 Hz to 10 Hz                                 |                 | 350             |                 | $\mu V_{PP}$     |
| $I_{SC}$                           | Short Circuit Current               |   |                 |                 | <b>75</b>       | mA               |
| $V_{IL}$                           | Enable Pin Maximum Low Input Level  |   |                 |                 | <b>35</b>       | %V               |
| $V_{IH}$                           | Enable Pin Minimum High Input Level |   | <b>65</b>       |                 |                 | %V               |

**Note 1:** Absolute Maximum Ratings indicate limits beyond which damage may occur to the device. Operating Ratings indicate conditions for which the device is intended to be functional, but do not guarantee specific performance limits. For guaranteed specifications, see Electrical Characteristics.

**Note 2:** Without PCB copper enhancements. The maximum power dissipation must be de-rated at elevated temperatures and is limited by  $T_{JMAX}$  (maximum junction temperature),  $\theta_{J-A}$  (junction to ambient thermal resistance) and  $T_A$  (ambient temperature). The maximum power dissipation at any temperature is:  $P_{DISSMAX} = (T_{JMAX} - T_A) / \theta_{J-A}$  up to the value listed in the Absolute Maximum Ratings.  $\theta_{J-A}$  for SOT23-5 package is  $220^\circ C/W$ ,  $T_{JMAX} = 125^\circ C$ .

**Note 3:** The human body model is a 100 pF capacitor discharged through a 1.5 k $\Omega$  resistor into each pin.

**Note 4:** Limits are 100% production tested at  $25^\circ C$ . Limits over the operating temperature range are guaranteed through correlation using Statistical Quality Control.

**Note 5:** Typical numbers are at  $25^\circ C$  and represent the most likely parametric norm.

**Note 6:** Temperature coefficient is measured by the "Box" method; i.e., the maximum  $\Delta V_{REF}$  is divided by the maximum  $\Delta T$ .

**Note 7:** Long term stability is  $V_{REF}$  @  $25^\circ C$  measured during 1000 hrs.

**Note 8:** Thermal hysteresis is defined as the change in  $+25^\circ C$  output voltage before and after cycling the device from  $(-40^\circ C$  to  $125^\circ C)$ .

**Note 9:** Dropout voltage is defined as the minimum input to output differential at which the output voltage drops by 0.5% below the value measured with a 5V input.

# Typical Performance Characteristics for 2.5V

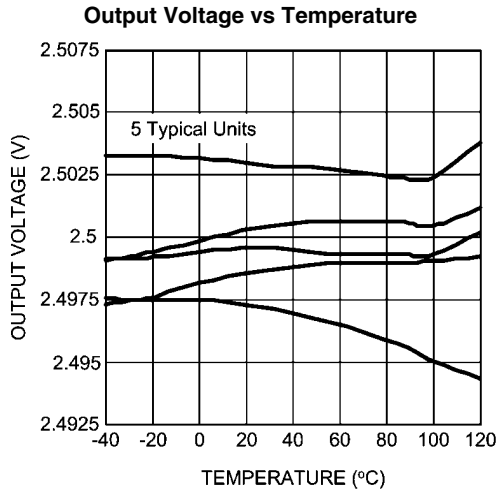

20211054

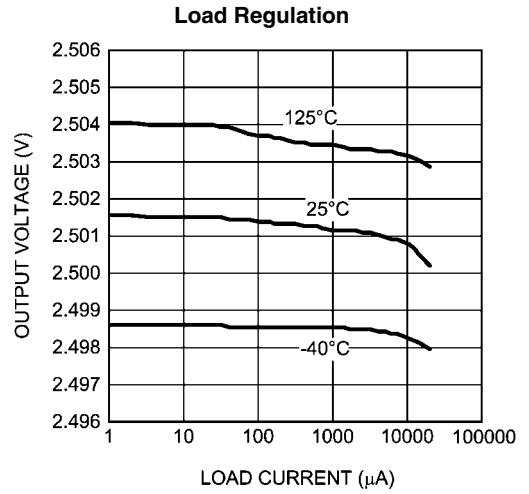

20211055

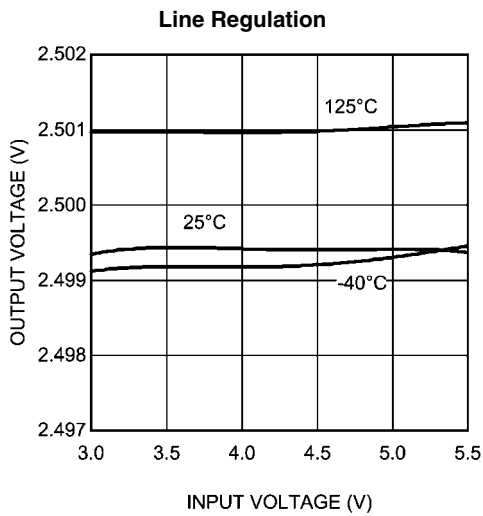

20211056

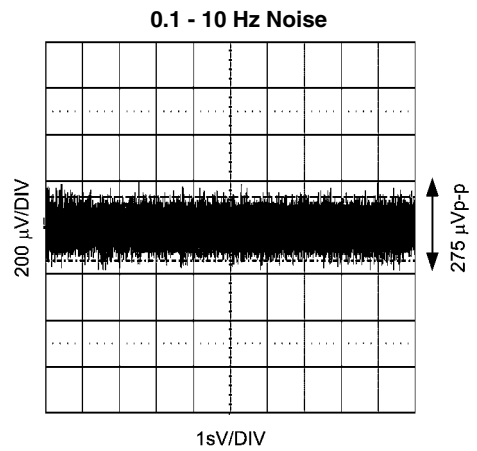

20211021

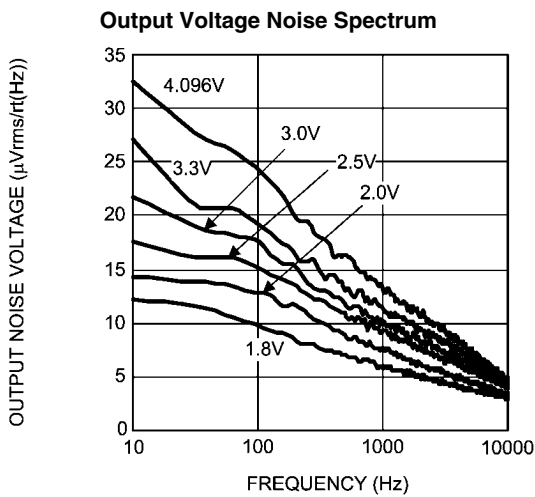

20211057

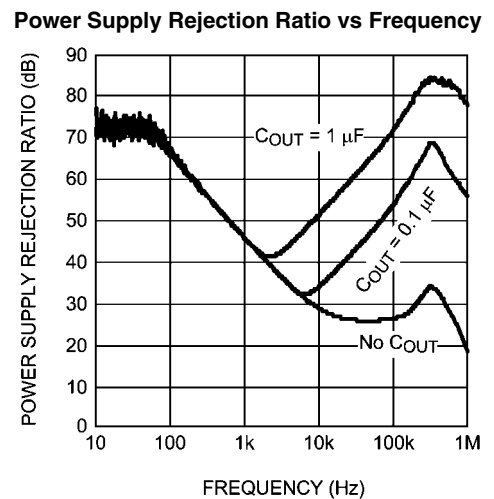

20211058

**Dropout vs Load to 0.5% Accuracy**

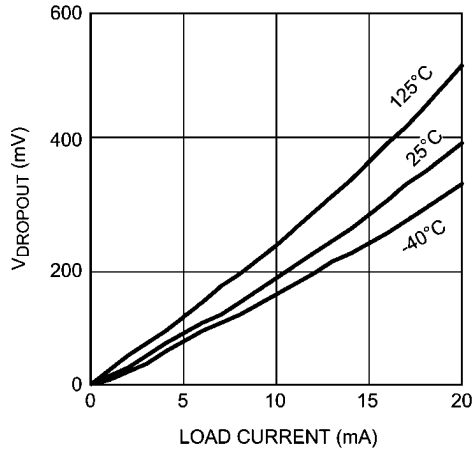

20211008

**Typical Long Term Stability**

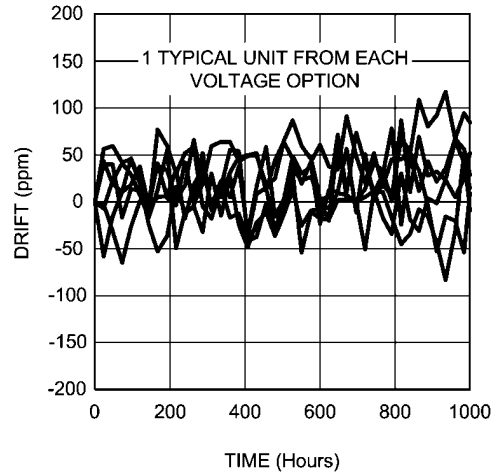

20211030

**Supply Current vs Input Voltage**

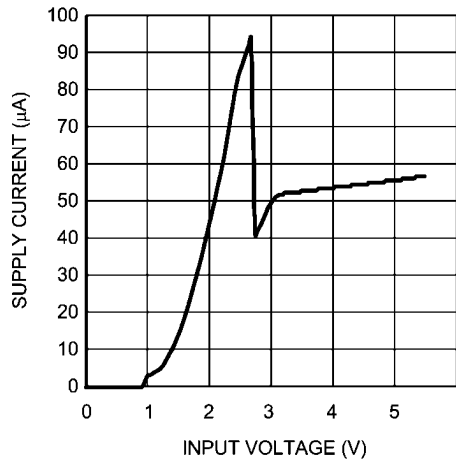

20211053

**Shutdown  $I_Q$  vs Input Voltage**

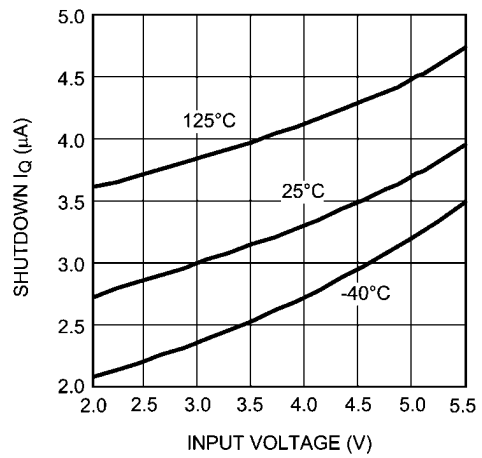

20211010

**Ground Current vs Load Current**

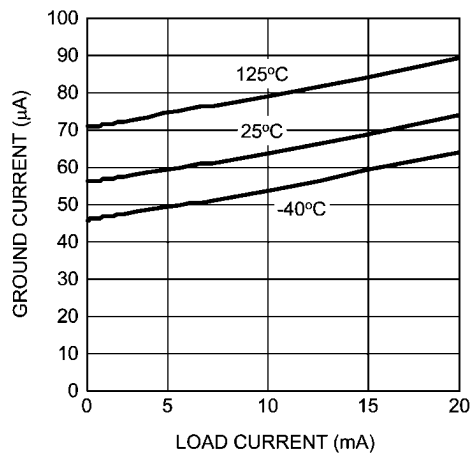

20211018

**Line Transient Response  
 $V_{IN} = 3V$  to  $5V$**

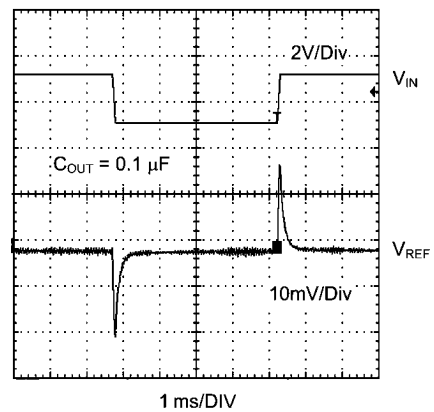

20211051

**Load Transient Response**  
 $I_{LOAD} = 0 \text{ to } 10\text{mA}$

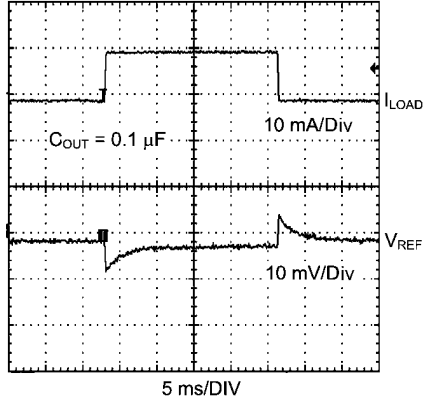

20211050

**Short-Circuit Protection and Recovery**

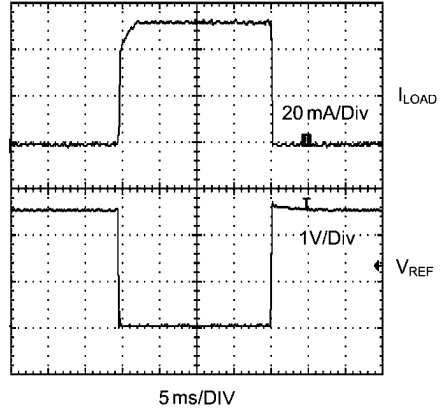

20211082

**Start-Up Response**

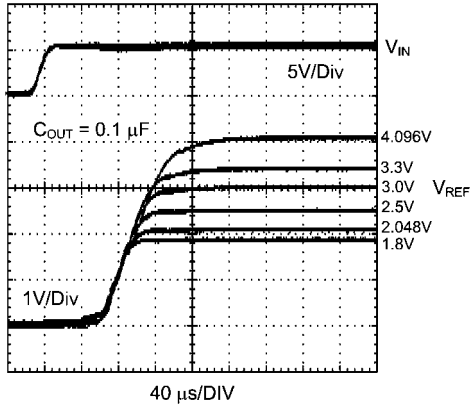

20211083

## Application Information

### THEORY OF OPERATION

The foundation of any voltage reference is the band-gap circuit. While the reference in the LM4128 is developed from the gate-source voltage of transistors in the IC, principles of the band-gap circuit are easily understood using a bipolar example. For a detailed analysis of the bipolar band-gap circuit, please refer to Application Note AN-56.

### SUPPLY AND ENABLE VOLTAGES

To ensure proper operation,  $V_{EN}$  and  $V_{IN}$  must be within a specified range. An acceptable range of input voltages is

$$V_{IN} > V_{REF} + 400 \text{ mV} \quad (I_{LOAD} \leq 10 \text{ mA})$$

The enable pin uses an internal pull-up current source ( $I_{PULL\_UP} \approx 2 \mu\text{A}$ ) that may be left floating or triggered by an external source. If the part is not enabled by an external source, it may be connected to  $V_{IN}$ . An acceptable range of enable voltages is given by the enable transfer characteristics. See the Electrical Characteristics section and Enable Transfer Characteristics figure for more detail. Note, the part will not operate correctly for  $V_{EN} > V_{IN}$ .

### COMPONENT SELECTION

A small ceramic (X5R or X7R) capacitor on the input must be used to ensure stable operation. The value of  $C_{IN}$  must be sized according to the output capacitor value. The value of  $C_{IN}$  must satisfy the relationship  $C_{IN} \geq C_{OUT}$ . When no output capacitor is used,  $C_{IN}$  must have a minimum value of 0.1  $\mu\text{F}$ . Noise on the power-supply input may affect the output noise. Larger input capacitor values (typically 4.7  $\mu\text{F}$  to 22  $\mu\text{F}$ ) may help reduce noise on the output and significantly reduce overshoot during startup. Use of an additional optional bypass capacitor between the input and ground may help further reduce noise on the output. With an input capacitor, the LM4128 will drive any combination of resistance and capacitance up to  $V_{REF}/20 \text{ mA}$  and 10  $\mu\text{F}$  respectively.

The LM4128 is designed to operate with or without an output capacitor and is stable with capacitive loads up to 10  $\mu\text{F}$ . Connecting a capacitor between the output and ground will significantly improve the load transient response when switching from a light load to a heavy load. The output capacitor should not be made arbitrarily large because it will effect the turn-on time as well as line and load transients.

While a variety of capacitor chemistry types may be used, it is typically advisable to use low esr ceramic capacitors. Such capacitors provide a low impedance to high frequency signals, effectively bypassing them to ground. Bypass capacitors should be mounted close to the part. Mounting bypass capacitors close to the part will help reduce the parasitic trace components thereby improving performance.

### SHORT CIRCUITED OUTPUT

The LM4128 features indefinite short circuit protection. This protection limits the output current to 75 mA when the output is shorted to ground.

### TURN ON TIME

Turn on time is defined as the time taken for the output voltage to rise to 90% of the preset value. The turn on time depends on the load. The turn on time is typically 33.2  $\mu\text{s}$  when driving a 1  $\mu\text{F}$  load and 78.8  $\mu\text{s}$  when driving a 10  $\mu\text{F}$  load. Some users may experience an extended turn on time (up to 10 ms) under brown out conditions and low temperatures (-40°C).

### THERMAL HYSTERESIS

Thermal hysteresis is defined as the change in output voltage at 25°C after some deviation from 25°C. This is to say that thermal hysteresis is the difference in output voltage between two points in a given temperature profile. An illustrative temperature profile is shown in *Figure 1*.

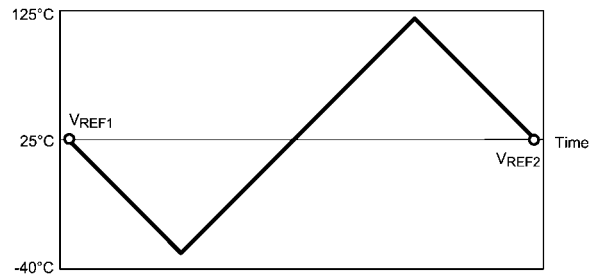

20211038

FIGURE 1. Illustrative Temperature Profile

This may be expressed analytically as the following:

$$V_{HYS} = \frac{|V_{REF1} - V_{REF2}|}{V_{REF}} \times 10^3 \text{ mV}$$

Where

$V_{HYS}$  = Thermal hysteresis expressed in ppm

$V_{REF}$  = Nominal preset output voltage

$V_{REF1} = V_{REF}$  before temperature fluctuation

$V_{REF2} = V_{REF}$  after temperature fluctuation.

The LM4128 features a low thermal hysteresis of 190  $\mu\text{V}$  from -40°C to 125°C.

### TEMPERATURE COEFFICIENT

Temperature drift is defined as the maximum deviation in output voltage over the operating temperature range. This deviation over temperature may be illustrated as shown in *Figure 2*.

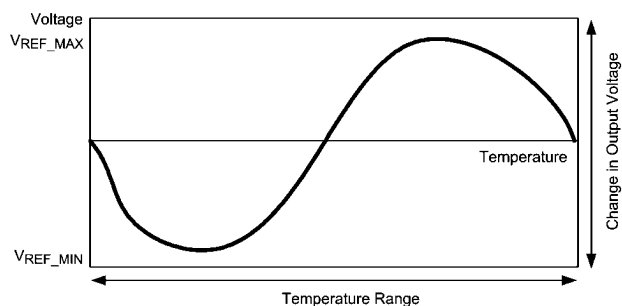

20211039

FIGURE 2. Illustrative Temperature Coefficient Profile

Temperature coefficient may be expressed analytically as the following:

$$T_D = \frac{(V_{REF\_MAX} - V_{REF\_MIN})}{V_{REF} \times \Delta T} \times 10^6 \text{ ppm}$$

$T_D$  = Temperature drift

$V_{REF}$  = Nominal preset output voltage

$V_{REF\_MIN}$  = Minimum output voltage over operating temperature range

$V_{REF\_MAX}$  = Maximum output voltage over operating temperature range

$\Delta T$  = Operating temperature range.

The LM4128 features a low temperature drift of 75 ppm (max) to 100 ppm (max), depending on the grade, from -40°C to 125°C.

### LONG TERM STABILITY

Long-term stability refers to the fluctuation in output voltage over a long period of time (1000 hours). The LM4128 features a typical long-term stability of 50 ppm over 1000 hours. The measurements are made using 5 units of each voltage option, at a nominal input voltage (5V), with no load, at room temperature.

### EXPRESSION OF ELECTRICAL CHARACTERISTICS

Electrical characteristics are typically expressed in mV, ppm, or a percentage of the nominal value. Depending on the application, one expression may be more useful than the other. To convert one quantity to the other one may apply the following:

ppm to mV error in output voltage:

$$\frac{V_{REF} \times \text{ppm}_{ERROR}}{10^3} = V_{ERROR}$$

Where:

$V_{REF}$  is in volts (V) and  $V_{ERROR}$  is in milli-volts (mV).

Bit error (1 bit) to voltage error (mV):

$$\frac{V_{REF}}{2^n} \times 10^3 = V_{ERROR}$$

$V_{REF}$  is in volts (V),  $V_{ERROR}$  is in milli-volts (mV), and n is the number of bits.

mV to ppm error in output voltage:

$$\frac{V_{ERROR}}{V_{REF}} \times 10^3 = \text{ppm}_{ERROR}$$

Where:

$V_{REF}$  is in volts (V) and  $V_{ERROR}$  is in milli-volts (mV).

Voltage error (mV) to percentage error (percent):

$$\frac{V_{ERROR}}{V_{REF}} \times 0.1 = \text{Percent\_Error}$$

Where:

$V_{REF}$  is in volts (V) and  $V_{ERROR}$  is in milli-volts (mV).

### PRINTED CIRCUIT BOARD and LAYOUT CONSIDERATIONS

References in SOT packages are generally less prone to PC board mounting than devices in Small Outline (SOIC) packages. To minimize the mechanical stress due to PC board mounting that can cause the output voltage to shift from its initial value, mount the reference on a low flex area of the PC board, such as near the edge or a corner.

The part may be isolated mechanically by cutting a U shape slot on the PCB for mounting the device. This approach also provides some thermal isolation from the rest of the circuit.

Bypass capacitors must be mounted close to the part. Mounting bypass capacitors close to the part will reduce the parasitic trace components thereby improving performance.

# Typical Application Circuits

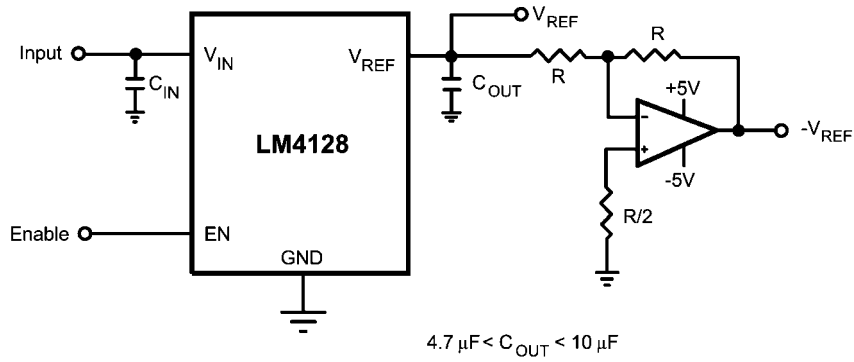

20211026

**FIGURE 3. Voltage Reference with Complimentary Output**

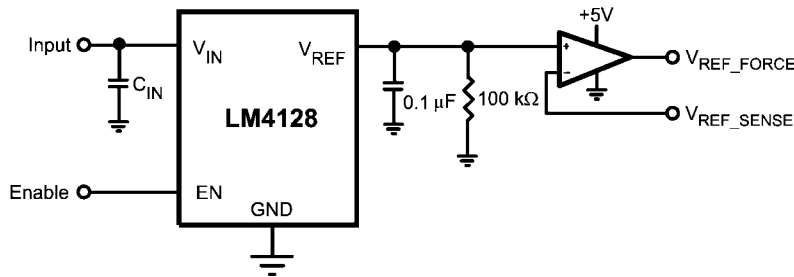

20211027

**FIGURE 4. Precision Voltage Reference with Force and Sense Output**

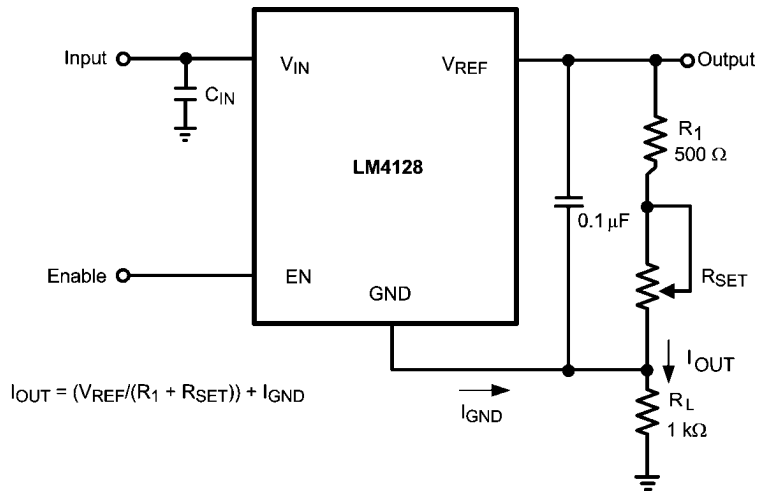

20211028

**FIGURE 5. Programmable Current Source**

**Physical Dimensions** inches (millimeters) unless otherwise noted

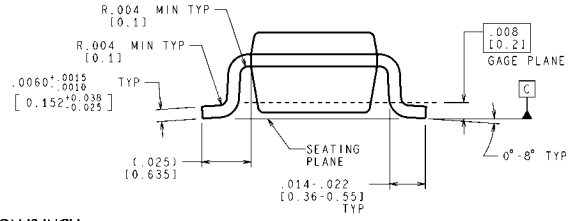
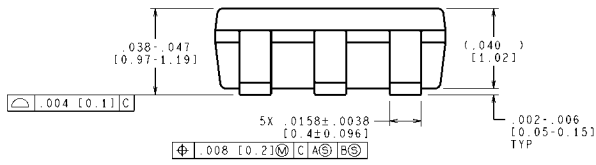
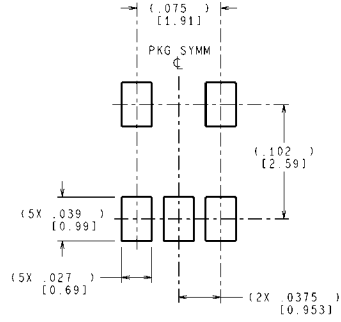
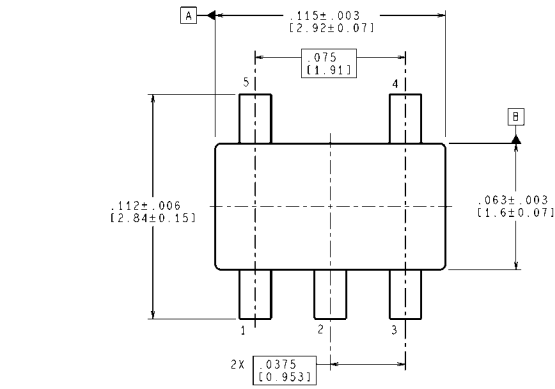

CONTROLLING DIMENSION IS INCH  
 VALUES IN [ ] ARE MILLIMETERS  
 DIMENSIONS IN ( ) FOR REFERENCE ONLY

**SOT23-5 Package**  
**NS Package Number MF05A**

MF05A (Rev D)

# Notes

## Notes

For more National Semiconductor product information and proven design tools, visit the following Web sites at:

| Products                       |  | Design Support          |  |
|--------------------------------|--|-------------------------|--|
| Amplifiers                     | <a href="http://www.national.com/amplifiers">www.national.com/amplifiers</a>   | WEBENCH                 | <a href="http://www.national.com/webench">www.national.com/webench</a>             |
| Audio                          | <a href="http://www.national.com/audio">www.national.com/audio</a>             | Analog University       | <a href="http://www.national.com/AU">www.national.com/AU</a>                       |
| Clock Conditioners             | <a href="http://www.national.com/timing">www.national.com/timing</a>           | App Notes               | <a href="http://www.national.com/appnotes">www.national.com/appnotes</a>           |
| Data Converters                | <a href="http://www.national.com/adc">www.national.com/adc</a>                 | Distributors            | <a href="http://www.national.com/contacts">www.national.com/contacts</a>           |
| Displays                       | <a href="http://www.national.com/displays">www.national.com/displays</a>       | Green Compliance        | <a href="http://www.national.com/quality/green">www.national.com/quality/green</a> |
| Ethernet                       | <a href="http://www.national.com/ethernet">www.national.com/ethernet</a>       | Packaging               | <a href="http://www.national.com/packaging">www.national.com/packaging</a>         |
| Interface                      | <a href="http://www.national.com/interface">www.national.com/interface</a>     | Quality and Reliability | <a href="http://www.national.com/quality">www.national.com/quality</a>             |
| LVDS                           | <a href="http://www.national.com/lvds">www.national.com/lvds</a>               | Reference Designs       | <a href="http://www.national.com/refdesigns">www.national.com/refdesigns</a>       |
| Power Management               | <a href="http://www.national.com/power">www.national.com/power</a>             | Feedback                | <a href="http://www.national.com/feedback">www.national.com/feedback</a>           |
| Switching Regulators           | <a href="http://www.national.com/switchers">www.national.com/switchers</a>     |                         |  |
| LDOs                           | <a href="http://www.national.com/ldo">www.national.com/ldo</a>                 |                         |  |
| LED Lighting                   | <a href="http://www.national.com/led">www.national.com/led</a>                 |                         |  |
| PowerWise                      | <a href="http://www.national.com/powerwise">www.national.com/powerwise</a>     |                         |  |
| Serial Digital Interface (SDI) | <a href="http://www.national.com/sdi">www.national.com/sdi</a>                 |                         |  |
| Temperature Sensors            | <a href="http://www.national.com/tempsensors">www.national.com/tempsensors</a> |                         |  |
| Wireless (PLL/VCO)             | <a href="http://www.national.com/wireless">www.national.com/wireless</a>       |                         |  |

THE CONTENTS OF THIS DOCUMENT ARE PROVIDED IN CONNECTION WITH NATIONAL SEMICONDUCTOR CORPORATION ("NATIONAL") PRODUCTS. NATIONAL MAKES NO REPRESENTATIONS OR WARRANTIES WITH RESPECT TO THE ACCURACY OR COMPLETENESS OF THE CONTENTS OF THIS PUBLICATION AND RESERVES THE RIGHT TO MAKE CHANGES TO SPECIFICATIONS AND PRODUCT DESCRIPTIONS AT ANY TIME WITHOUT NOTICE. NO LICENSE, WHETHER EXPRESS, IMPLIED, ARISING BY ESTOPPEL OR OTHERWISE, TO ANY INTELLECTUAL PROPERTY RIGHTS IS GRANTED BY THIS DOCUMENT.

TESTING AND OTHER QUALITY CONTROLS ARE USED TO THE EXTENT NATIONAL DEEMS NECESSARY TO SUPPORT NATIONAL'S PRODUCT WARRANTY. EXCEPT WHERE MANDATED BY GOVERNMENT REQUIREMENTS, TESTING OF ALL PARAMETERS OF EACH PRODUCT IS NOT NECESSARILY PERFORMED. NATIONAL ASSUMES NO LIABILITY FOR APPLICATIONS ASSISTANCE OR BUYER PRODUCT DESIGN. BUYERS ARE RESPONSIBLE FOR THEIR PRODUCTS AND APPLICATIONS USING NATIONAL COMPONENTS. PRIOR TO USING OR DISTRIBUTING ANY PRODUCTS THAT INCLUDE NATIONAL COMPONENTS, BUYERS SHOULD PROVIDE ADEQUATE DESIGN, TESTING AND OPERATING SAFEGUARDS.

EXCEPT AS PROVIDED IN NATIONAL'S TERMS AND CONDITIONS OF SALE FOR SUCH PRODUCTS, NATIONAL ASSUMES NO LIABILITY WHATSOEVER, AND NATIONAL DISCLAIMS ANY EXPRESS OR IMPLIED WARRANTY RELATING TO THE SALE AND/OR USE OF NATIONAL PRODUCTS INCLUDING LIABILITY OR WARRANTIES RELATING TO FITNESS FOR A PARTICULAR PURPOSE, MERCHANTABILITY, OR INFRINGEMENT OF ANY PATENT, COPYRIGHT OR OTHER INTELLECTUAL PROPERTY RIGHT.

### LIFE SUPPORT POLICY

**NATIONAL'S PRODUCTS ARE NOT AUTHORIZED FOR USE AS CRITICAL COMPONENTS IN LIFE SUPPORT DEVICES OR SYSTEMS WITHOUT THE EXPRESS PRIOR WRITTEN APPROVAL OF THE CHIEF EXECUTIVE OFFICER AND GENERAL COUNSEL OF NATIONAL SEMICONDUCTOR CORPORATION.** As used herein:

Life support devices or systems are devices which (a) are intended for surgical implant into the body, or (b) support or sustain life and whose failure to perform when properly used in accordance with instructions for use provided in the labeling can be reasonably expected to result in a significant injury to the user. A critical component is any component in a life support device or system whose failure to perform can be reasonably expected to cause the failure of the life support device or system or to affect its safety or effectiveness.

National Semiconductor and the National Semiconductor logo are registered trademarks of National Semiconductor Corporation. All other brand or product names may be trademarks or registered trademarks of their respective holders.

Copyright© 2008 National Semiconductor Corporation

For the most current product information visit us at [www.national.com](http://www.national.com)



**National Semiconductor  
Americas Technical  
Support Center**  
Email: [support@nsc.com](mailto:support@nsc.com)  
Tel: 1-800-272-9959



**National Semiconductor Europe  
Technical Support Center**  
Email: [europe.support@nsc.com](mailto:europe.support@nsc.com)  
German Tel: +49 (0) 180 5010 771  
English Tel: +44 (0) 870 850 4288

**National Semiconductor Asia  
Pacific Technical Support Center**  
Email: [ap.support@nsc.com](mailto:ap.support@nsc.com)

**National Semiconductor Japan  
Technical Support Center**  
Email: [jpn.feedback@nsc.com](mailto:jpn.feedback@nsc.com)

## Looking for pricing, stock, or lifecycle information?

Click below to explore more details on WIN SOURCE:

-  [View LM4128BMF-3.0 on WIN SOURCE](#)
-  [Texas Instruments](#) Information

## Optimize Your Supply Chain with WIN SOURCE Solutions

-  Global Sourcing Solution
-  Obsolete Management
-  Cost Control Management
-  Shortage Management
-  Alternative Solution
-  Excess Inventory Management