



**THE DATASHEET OF  
DCX124EU-7**



## Features

- Supply Voltage  $V_O = 50V$
- Range of Bias Resistors
- Surface-Mount Package Suited for Automated Assembly
- Totally Lead-Free & Fully RoHS Compliant (Notes 1 & 2)**
- Halogen and Antimony Free. "Green" Device (Note 3)**
- The DCX (XXXX) UQs are suitable for automotive applications requiring specific change control; these parts are AEC-Q101 qualified, PPAP capable, and manufactured in IATF 16949 certified facilities.**

<https://www.diodes.com/quality/product-definitions/>

Part Number	R1(NOM)	R2(NOM)
DCX124EU	22k $\Omega$	22k $\Omega$
DCX144EU	47k $\Omega$	47k $\Omega$
DCX114YU	10k $\Omega$	47k $\Omega$
DCX123JU	2.2k $\Omega$	47k $\Omega$
DCX114EU	10k $\Omega$	10k $\Omega$
DCX143EU	4.7k $\Omega$	4.7k $\Omega$
DCX143ZU	4.7k $\Omega$	47k $\Omega$
DCX115EU	100k $\Omega$	100k $\Omega$

## Mechanical Data

- Package: SOT363
- Package Material: Molded Plastic, "Green" Molding Compound; UL Flammability Classification Rating 94V-0
- Moisture Sensitivity: Level 1 per J-STD-020
- Terminals: Finish – Matte Tin Plated Leads, Solderable per MIL-STD-202, Method 208 Ⓒ3
- Weight: 0.006 grams (Approximate)

Part Number	R1 Only
DCX143TU	4.7k $\Omega$
DCX114TU	10k $\Omega$

SOT363

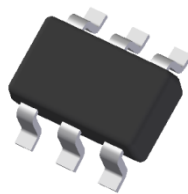

Top View

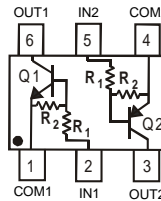

R1, R2

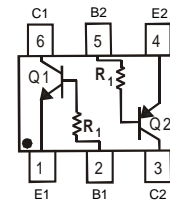

R1 Only

Device Schematic

## Ordering Information (Notes 4, 5)

Part Number	Status	Package	Marking	Reel Size (inches)	Tape Width (mm)	Packing	
						Qty.	Carrier
DCX124EU-7-F	Active	SOT363	C17	7	8	3,000	Reel
DCX124EU-13-F	Active	SOT363	C17	13	8	10,000	Reel
DCX124EUQ-7-F	NRND (Use <a href="#">ACX124EUQ</a> )	SOT363	C17	7	8	3,000	Reel
DCX124EUQ-13-F	NRND (Use <a href="#">ACX124EUQ</a> )	SOT363	C17	13	8	10,000	Reel
DCX124EUQ-13R-F	NRND (Use <a href="#">ACX124EUQ</a> )	SOT363	C17	13	8	10,000	Reel
DCX144EU-7-F	Active	SOT363	C20	7	8	3,000	Reel
DCX144EU-7R-F	Active	SOT363	C20	7	8	3,000	Reel
DCX144EUQ-7-F	Active	SOT363	C20	7	8	3,000	Reel
DCX144EUQ-7R-F	Active	SOT363	C20	7	8	3,000	Reel
DCX114YU-7-F	Active	SOT363	C14	7	8	3,000	Reel
DCX114YU-7R-F	Active	SOT363	C14	7	8	3,000	Reel
DCX114YUQ-7-F	NRND (Use <a href="#">ACX114YUQ</a> )	SOT363	C14	7	8	3,000	Reel
DCX114YUQ-13-F	NRND (Use <a href="#">ACX114YUQ</a> )	SOT363	C14	13	8	10,000	Reel
DCX114YUQ-13R-F	NRND (Use <a href="#">ACX114YUQ</a> )	SOT363	C14	13	8	10,000	Reel
DCX123JU-7-F	Active	SOT363	C06	7	8	3,000	Reel
DCX123JU-7R-F	Active	SOT363	C06	7	8	3,000	Reel
DCX123JUQ-7-F	Active	SOT363	C06	7	8	3,000	Reel
DCX114EU-7-F	Active	SOT363	C13	7	8	3,000	Reel
DCX114EU-13R-F	Active	SOT363	C13	13	8	10,000	Reel

## Ordering Information (Notes 4, 5) (continued)

Part Number	Status	Package	Marking	Reel Size (inches)	Tape Width (mm)	Packing	
						Qty.	Carrier
DCX114EUQ-7-F	NRND (Use <a href="#">ACX114EUQ</a> )	SOT363	C13	7	8	3,000	Reel
DCX114EUQ-13-F	NRND (Use <a href="#">ACX114EUQ</a> )	SOT363	C13	13	8	10,000	Reel
DCX114EUQ-13R-F	NRND (Use <a href="#">ACX114EUQ</a> )	SOT363	C13	13	8	10,000	Reel
DCX143TU-7-F	Active	SOT363	C07	7	8	3,000	Reel
DCX143EU-7-F	Active	SOT363	C08	7	8	3,000	Reel
DCX143EU-7R-F	Active	SOT363	C08	7	8	3,000	Reel
DCX114TU-7-F	Active	SOT363	C12	7	8	3,000	Reel
DCX143ZU-7-F	Active	SOT363	C02	7	8	3,000	Reel
DCX143ZU-7R-F	Active	SOT363	C02	7	8	3,000	Reel
DCX115EU-7-F	Active	SOT363	C01	7	8	3,000	Reel

- Notes:
1. No purposely added lead. Fully EU Directive 2002/95/EC (RoHS), 2011/65/EU (RoHS 2) & 2015/863/EU (RoHS 3) compliant.
  2. See <https://www.diodes.com/quality/lead-free/> for more information about Diodes Incorporated's definitions of Halogen- and Antimony-free, "Green" and Lead-free.
  3. Halogen- and Antimony-free "Green" products are defined as those which contain <900ppm bromine, <900ppm chlorine (<1500ppm total Br + Cl) and <1000ppm antimony compounds.
  4. For packaging details, go to our website at <https://www.diodes.com/design/support/packaging/diodes-packaging/>.
  5. NRND = Not Recommended for New Design.

## Marking Information

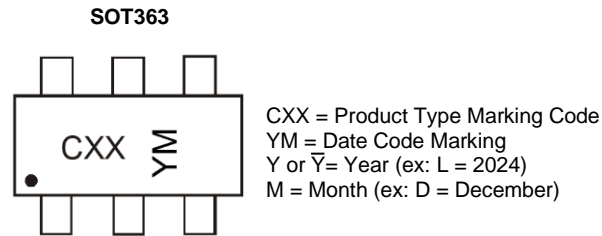

### Date Code Key

Year	2010	-	2024	2025	2026	2027	2028	2029	2030	2031	2032	2033
Code	X	-	L	M	N	P	R	S	T	U	V	W

Month	Jan	Feb	Mar	Apr	May	Jun	Jul	Aug	Sep	Oct	Nov	Dec
Code	1	2	3	4	5	6	7	8	9	O	N	D

**Absolute Maximum Ratings NPN Section** (@ T<sub>A</sub> = +25°C, unless otherwise specified.)

Characteristic		Symbol	Value	Unit
Supply Voltage		V <sub>O</sub>	50	V
Input Voltage	DCX124EU	V <sub>I</sub>	-10 to +40	V
	DCX144EU		-10 to +40	
	DCX114YU		-6 to +40	
	DCX123JU		-5 to +12	
	DCX114EU		-10 to +40	
	DCX143TU		-5V Max	
	DCX143EU		-10 to +30	
	DCX114TU		-5V Max	
	DCX143ZU		-10 to +30	
DCX115EU	-10 to +40			
Output Current	DCX124EU	I <sub>O</sub>	30	mA
	DCX144EU		30	
	DCX114YU		70	
	DCX123JU		100	
	DCX114EU		50	
	DCX143TU		100	
	DCX143EU		100	
	DCX114TU		100	
	DCX143ZU		100	
DCX115EU	20			
Peak Output Current		I <sub>CM</sub>	100	mA

**Absolute Maximum Ratings PNP Section** (@ T<sub>A</sub> = +25°C, unless otherwise specified.)

Characteristic		Symbol	Value	Unit
Supply Voltage		V <sub>O</sub>	50	V
Input Voltage	DCX124EU	V <sub>I</sub>	+10 to -40	V
	DCX144EU		+10 to -40	
	DCX114YU		+6 to -40	
	DCX123JU		+5 to -12	
	DCX114EU		+10 to -40	
	DCX143TU		+5V Max	
	DCX143EU		+10 to -30	
	DCX114TU		+5V Max	
	DCX143ZU		+5 to -30	
DCX115EU	+10 to -40			
Output Current	DCX124EU	I <sub>O</sub>	-30	mA
	DCX144EU		-30	
	DCX114YU		-70	
	DCX123JU		-100	
	DCX114EU		-50	
	DCX143TU		-100	
	DCX143EU		-100	
	DCX114TU		-100	
	DCX143ZU		-100	
DCX115EU	-20			
Peak Output Current		I <sub>CM</sub>	-100	mA

**Thermal Characteristics** (@ T<sub>A</sub> = +25°C, unless otherwise specified.)

Characteristic	Symbol	Value	Unit
Power Dissipation (Notes 6, 7)	P <sub>D</sub>	200	mW
Thermal Resistance, Junction to Ambient Air (Note 6)	R <sub>θJA</sub>	625	°C/W
Operating and Storage Temperature Range	T <sub>J</sub> , T <sub>STG</sub>	-55 to +150	°C

Notes: 6. Mounted on FR-4 PC Board with minimum recommended pad layout.  
7. 150mW per element must not be exceeded.

**Thermal Characteristics** (@  $T_A = +25^\circ\text{C}$ , unless otherwise specified.)

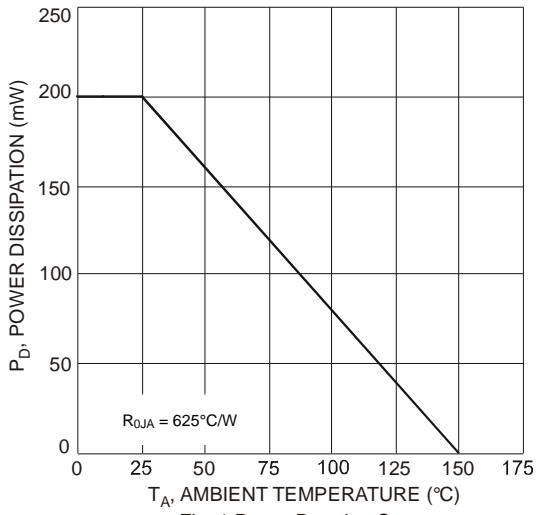

Fig. 1 Power Derating Curve

**Electrical Characteristics NPN Section** (@ T<sub>A</sub> = +25°C, unless otherwise specified.)

Characteristic		Symbol	Min	Typ	Max	Unit	Test Condition	
<b>R1 Only (DCX143TU &amp; DCX114TU)</b>								
Collector-Base Breakdown Voltage		BV <sub>CBO</sub>	50	—	—	V	I <sub>C</sub> = 50μA	
Collector-Emitter Breakdown Voltage		BV <sub>CEO</sub>	50	—	—	V	I <sub>C</sub> = 1mA	
Emitter-Base Breakdown Voltage		BV <sub>EBO</sub>	5	—	—	V	I <sub>E</sub> = 50μA	
Collector Cutoff Current		I <sub>CBO</sub>	—	—	0.5	μA	V <sub>CB</sub> = 50V	
Emitter Cutoff Current		I <sub>EBO</sub>	—	—	0.5	μA	V <sub>EB</sub> = 4V	
Collector-Emitter Saturation Voltage		V <sub>CE(sat)</sub>	—	—	0.3	V	I <sub>C</sub> /I <sub>B</sub> = 2.5mA / 0.25mA DCX143TU I <sub>C</sub> /I <sub>B</sub> = 1mA / 0.1mA DCX114TU	
DC Current Transfer Ratio		h <sub>FE</sub>	100	250	600	—	I <sub>C</sub> = 1mA, V <sub>CE</sub> = 5V	
Input Resistor (R <sub>1</sub> ) Tolerance		ΔR <sub>1</sub>	-30	—	+30	%	—	
Gain-Bandwidth Product		f <sub>T</sub>	—	250	—	MHz	V <sub>CE</sub> = 10V, I <sub>E</sub> = 5mA, f = 100MHz	
<b>R1/R2 Only</b>								
Input Voltage	DCX124EU	V <sub>I(off)</sub>	0.5	1.1	—	V	V <sub>CC</sub> = 5V, I <sub>O</sub> = 100μA	
	DCX144EU		0.5	1.1				
	DCX114YU		0.3	—				
	DCX123JU		0.5	—				
	DCX114EU		0.5	1.1				
	DCX143EU		0.5	1.16				
	DCX143ZU		0.5	—				
	DCX115EU		0.5	—				
	DCX124EU	V <sub>I(on)</sub>	—	1.9	3.0	V	V <sub>O</sub> = 0.3V, I <sub>O</sub> = 5mA	
	DCX144EU		—	1.9	3.0		V <sub>O</sub> = 0.3V, I <sub>O</sub> = 2mA	
	DCX114YU		—	—	1.4		V <sub>O</sub> = 0.3V, I <sub>O</sub> = 1mA	
	DCX123JU		—	—	1.1		V <sub>O</sub> = 0.3V, I <sub>O</sub> = 5mA	
	DCX114EU		—	1.9	3.0		V <sub>O</sub> = 0.3V, I <sub>O</sub> = 10mA	
	DCX143EU		—	1.99	3.0		V <sub>O</sub> = 0.3V, I <sub>O</sub> = 20mA	
DCX143ZU	—		—	1.3	V <sub>O</sub> = 0.3V, I <sub>O</sub> = 5mA			
DCX115EU	—	—	3	V <sub>O</sub> = 0.3V, I <sub>O</sub> = 1mA				
Output Voltage	DCX124EU	V <sub>O(on)</sub>	—	0.1	0.3	V	I <sub>O</sub> /I <sub>I</sub> = 10mA / 0.5mA	
	DCX144EU						I <sub>O</sub> /I <sub>I</sub> = 10mA / 0.5mA	
	DCX114YU						I <sub>O</sub> /I <sub>I</sub> = 5mA / 0.25mA	
	DCX123JU						I <sub>O</sub> /I <sub>I</sub> = 5mA / 0.25mA	
	DCX114EU						I <sub>O</sub> /I <sub>I</sub> = 10mA / 0.5mA	
	DCX143EU						I <sub>O</sub> /I <sub>I</sub> = 10mA / 0.5mA	
	DCX143ZU						I <sub>O</sub> /I <sub>I</sub> = 5mA / 0.25mA	
	DCX115EU						I <sub>O</sub> /I <sub>I</sub> = 10mA / 0.5mA	
Input Current	DCX124EU	I <sub>I</sub>	—	—	—	mA	V <sub>I</sub> = 5V	
	DCX144EU							0.36
	DCX114YU							0.18
	DCX123JU							0.88
	DCX114EU							3.6
	DCX143EU							0.88
	DCX143ZU							1.8
	DCX115EU							0.15
Output Current		I <sub>O(off)</sub>	—	—	0.5	μA	V <sub>CC</sub> = 50V, V <sub>I</sub> = 0V	
DC Current Gain	DCX124EU	G <sub>I</sub>	56	—	—	—	V <sub>O</sub> = 5V, I <sub>O</sub> = 5mA	
	DCX124EUQ						60	V <sub>O</sub> = 5V, I <sub>O</sub> = 5mA
	DCX144EU						68	V <sub>O</sub> = 5V, I <sub>O</sub> = 5mA
	DCX114YU						68	V <sub>O</sub> = 5V, I <sub>O</sub> = 10mA
	DCX114YUQ						80	V <sub>O</sub> = 5V, I <sub>O</sub> = 10mA
	DCX123JU						80	V <sub>O</sub> = 5V, I <sub>O</sub> = 10mA
	DCX114EU						30	V <sub>O</sub> = 5V, I <sub>O</sub> = 5mA
	DCX143EU						50	V <sub>O</sub> = 5V, I <sub>O</sub> = 10mA
	DCX143ZU						80	V <sub>O</sub> = 5V, I <sub>O</sub> = 10mA
DCX115EU	82	V <sub>O</sub> = 5V, I <sub>O</sub> = 5mA						
Input Resistor (R <sub>1</sub> ) Tolerance		ΔR <sub>1</sub>	-30	—	+30	%	—	
Resistance Ratio Tolerance		ΔR <sub>2</sub> /R <sub>1</sub>	-20	—	+20	%	—	
Gain-Bandwidth Product		f <sub>T</sub>	—	250	—	MHz	V <sub>CE</sub> = 10V, I <sub>E</sub> = 5mA, f = 100MHz	

**Electrical Characteristics PNP Section** (@  $T_A = +25^\circ\text{C}$ , unless otherwise specified.)

Characteristic		Symbol	Min	Typ	Max	Unit	Test Condition	
<b>R1 Only (DCX143TU &amp; DCX114TU)</b>								
Collector-Base Breakdown Voltage		$BV_{CBO}$	-50	—	—	V	$I_C = -50\mu\text{A}$	
Collector-Emitter Breakdown Voltage		$BV_{CEO}$	-50	—	—	V	$I_C = -1\text{mA}$	
Emitter-Base Breakdown Voltage		$BV_{EBO}$	-5	—	—	V	$I_E = -50\mu\text{A}$	
Collector Cutoff Current		$I_{CBO}$	—	—	-0.5	$\mu\text{A}$	$V_{CB} = -50\text{V}$	
Emitter Cutoff Current		$I_{EBO}$	—	—	-0.5	$\mu\text{A}$	$V_{EB} = -4\text{V}$	
Collector-Emitter Saturation Voltage		$V_{CE(sat)}$	—	—	-0.3	V	$I_C/I_B = 2.5\text{mA} / 0.25\text{mA}$ DCX143TU $I_C/I_B = 1\text{mA} / 0.1\text{mA}$ DCX114TU	
DC Current Transfer Ratio		$h_{FE}$	100	250	600	—	$I_C = -1\text{mA}$ , $V_{CE} = -5\text{V}$	
Input Resistor ( $R_1$ ) Tolerance		$\Delta R_1$	-30	—	+30	%	—	
Gain-Bandwidth Product		$f_T$	—	250	—	MHz	$V_{CE} = -10\text{V}$ , $I_E = -5\text{mA}$ , $f = 100\text{MHz}$	
<b>R1/R2 Only</b>								
Input Voltage	DCX124EU	$V_{I(off)}$	-0.5	-1.1	—	V	$V_{CC} = -5\text{V}$ , $I_O = -100\mu\text{A}$	
	DCX144EU		-0.5	-1.1				
	DCX114YU		-0.3	—				
	DCX123JU		-0.5	—				
	DCX114EU		-0.5	-1.1				
	DCX143EU		-0.5	-1.16				
	DCX143ZU		-0.5	—				
	DCX115EU		-0.5	—				
	DCX124EU	$V_{I(on)}$	—	-1.9	-3.0	V	$V_O = -0.3\text{V}$ , $I_O = -5\text{mA}$	
	DCX144EU		—	-1.9	-3.0		$V_O = -0.3\text{V}$ , $I_O = -2\text{mA}$	
	DCX114YU		—	—	-1.4		$V_O = -0.3\text{V}$ , $I_O = -1\text{mA}$	
	DCX123JU		—	—	-1.1		$V_O = -0.3\text{V}$ , $I_O = -5\text{mA}$	
	DCX114EU		—	-1.9	-3.0		$V_O = -0.3\text{V}$ , $I_O = -10\text{mA}$	
	DCX143EU		—	-2.5	-3.0		$V_O = -0.3\text{V}$ , $I_O = -20\text{mA}$	
DCX143ZU	—		—	-1.3	$V_O = -0.3\text{V}$ , $I_O = -5\text{mA}$			
DCX115EU	—	—	-3	$V_O = -0.3\text{V}$ , $I_O = -1\text{mA}$				
Output Voltage	DCX124EU	$V_{O(on)}$	—	-0.1	-0.3	V	$I_O/I_I = -10\text{mA} / -0.5\text{mA}$	
	DCX144EU						$I_O/I_I = -10\text{mA} / -0.5\text{mA}$	
	DCX114YU						$I_O/I_I = -5\text{mA} / -0.25\text{mA}$	
	DCX123JU						$I_O/I_I = -5\text{mA} / -0.25\text{mA}$	
	DCX114EU						$I_O/I_I = -10\text{mA} / -0.5\text{mA}$	
	DCX143EU						$I_O/I_I = -10\text{mA} / -0.5\text{mA}$	
	DCX143ZU						$I_O/I_I = -5\text{mA} / -0.25\text{mA}$	
	DCX115EU						$I_O/I_I = -10\text{mA} / -0.5\text{mA}$	
Input Current	DCX124EU	$I_I$	—	—	-0.36	mA	$V_I = -5\text{V}$	
	DCX144EU							-0.18
	DCX114YU							-0.88
	DCX123JU							-3.6
	DCX114EU							-0.88
	DCX143EU							-0.88
	DCX143ZU							-1.8
	DCX115EU							-0.15
Output Current		$I_{O(off)}$	—	—	-0.5	$\mu\text{A}$	$V_{CC} = -50\text{V}$ , $V_I = 0\text{V}$	
DC Current Gain	DCX124EU	$G_i$	56	—	—	—	$V_O = -5\text{V}$ , $I_O = -5\text{mA}$	
	DCX124EUQ						60	$V_O = -5\text{V}$ , $I_O = -5\text{mA}$
	DCX144EU						68	$V_O = -5\text{V}$ , $I_O = -5\text{mA}$
	DCX114YU						68	$V_O = -5\text{V}$ , $I_O = -10\text{mA}$
	DCX114YUQ						80	$V_O = -5\text{V}$ , $I_O = -10\text{mA}$
	DCX123JU						80	$V_O = -5\text{V}$ , $I_O = -10\text{mA}$
	DCX114EU						30	$V_O = -5\text{V}$ , $I_O = -5\text{mA}$
	DCX143EU						40	$V_O = -5\text{V}$ , $I_O = -10\text{mA}$
	DCX143ZU						80	$V_O = -5\text{V}$ , $I_O = -10\text{mA}$
	DCX115EU						82	$V_O = -5\text{V}$ , $I_O = -5\text{mA}$
Input Resistor ( $R_1$ ) Tolerance		$\Delta R_1$	-30	—	+30	%	—	
Resistance Ratio Tolerance		$\Delta R_2/R_1$	-20	—	+20	%	—	
Gain-Bandwidth Product		$f_T$	—	250	—	MHz	$V_{CE} = -10\text{V}$ , $I_E = -5\text{mA}$ , $f = 100\text{MHz}$	

**Typical Curves – DCX123JU PNP Section** (@  $T_A = +25^\circ\text{C}$ , unless otherwise specified.)

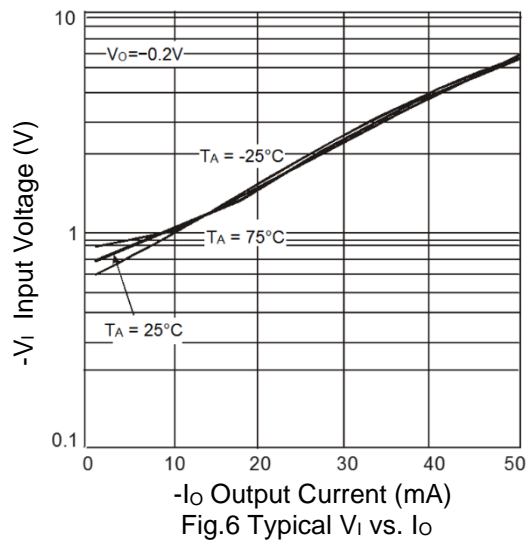
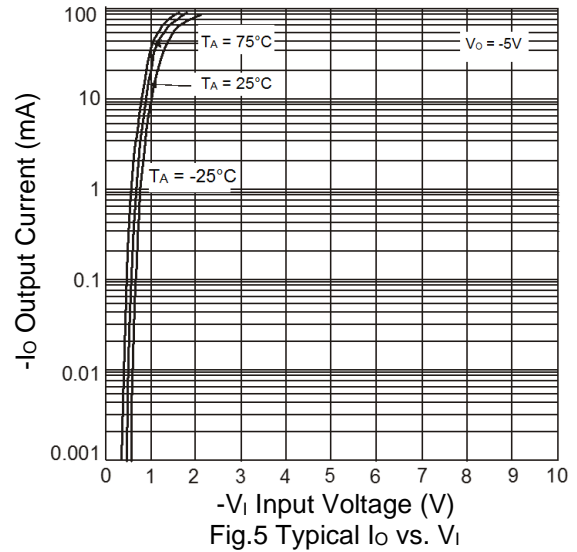
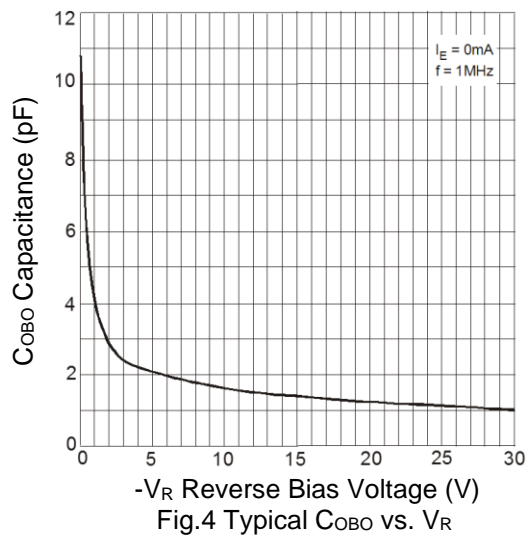
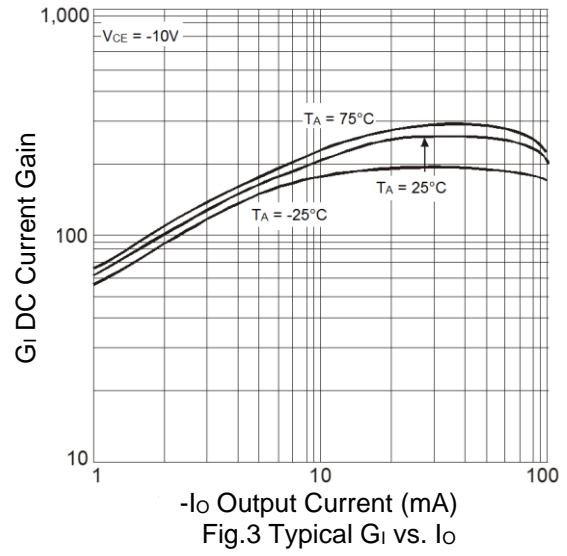
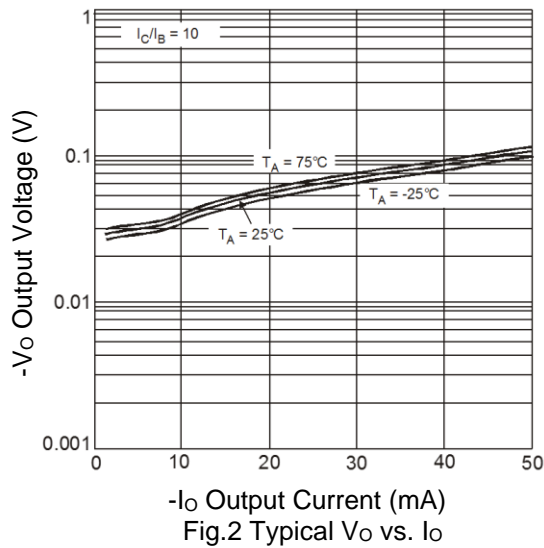

**Typical Curves – DCX123JU NPN Section** (@  $T_A = +25^\circ\text{C}$ , unless otherwise specified.)

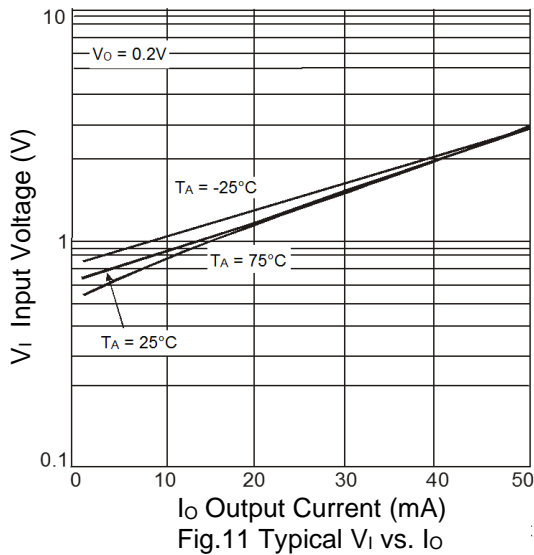
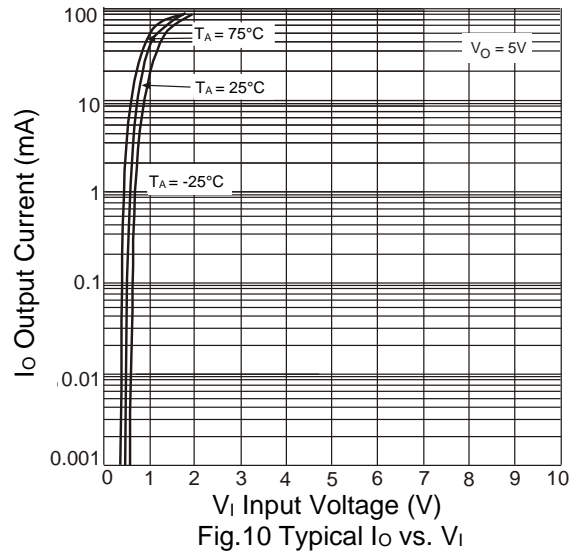
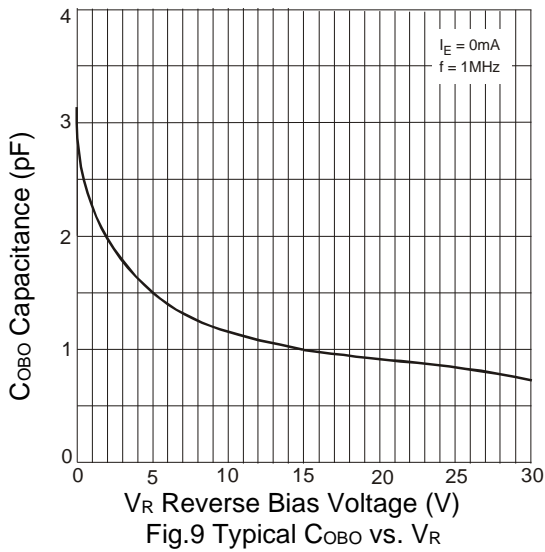
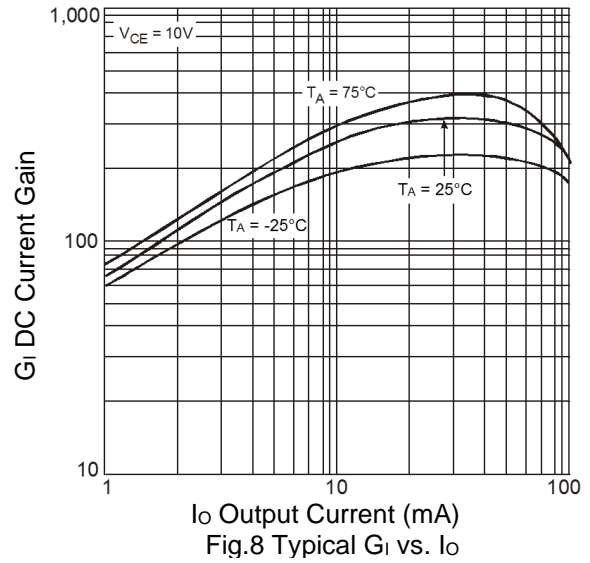
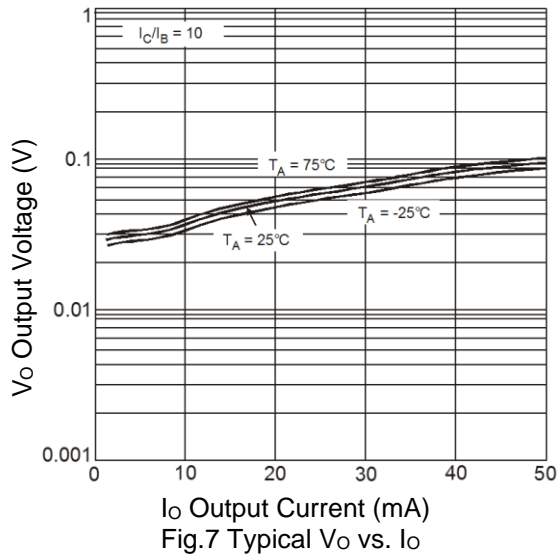

**Typical Curves – DCX143EU PNP Section** (@  $T_A = +25^\circ\text{C}$ , unless otherwise specified.)

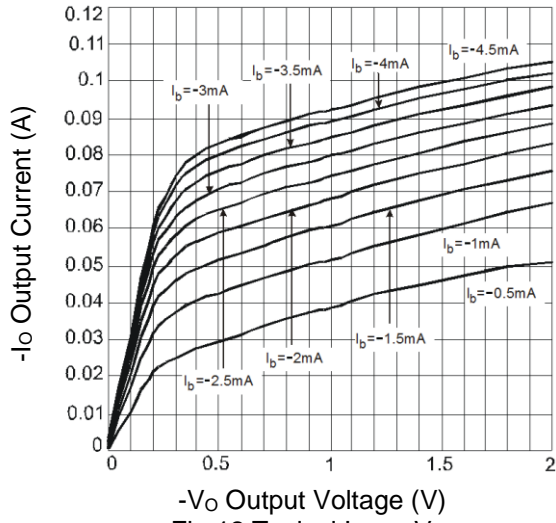

Fig.12 Typical  $I_o$  vs.  $V_o$

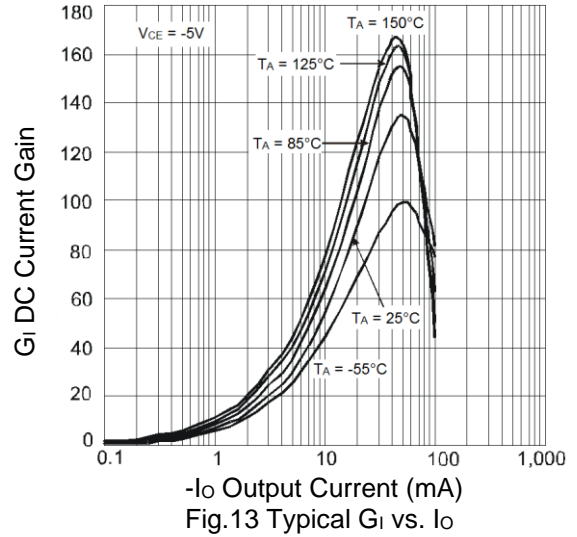

Fig.13 Typical  $G_i$  vs.  $I_o$

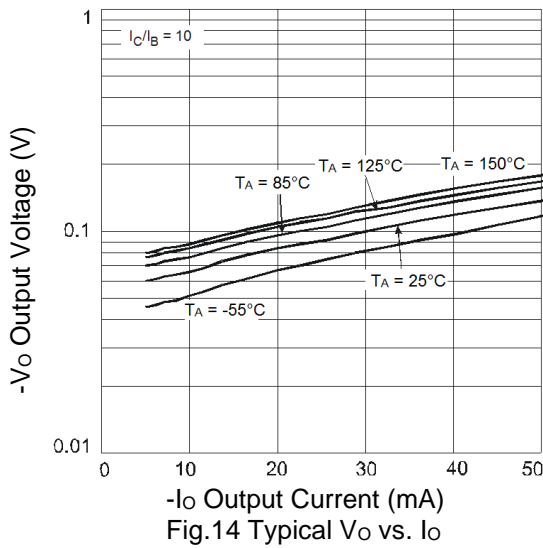

Fig.14 Typical  $V_o$  vs.  $I_o$

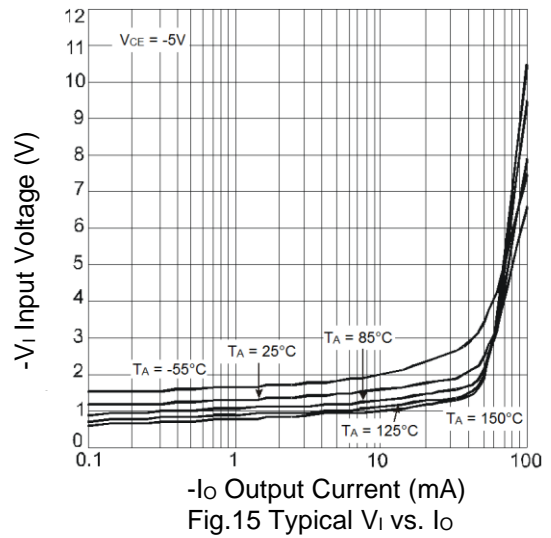

Fig.15 Typical  $V_i$  vs.  $I_o$

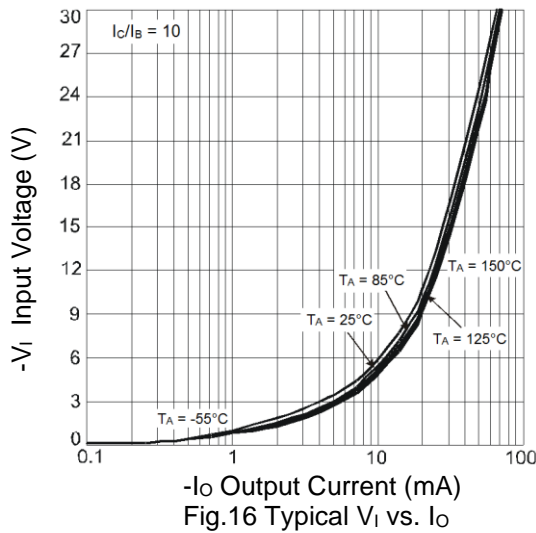

Fig.16 Typical  $V_i$  vs.  $I_o$

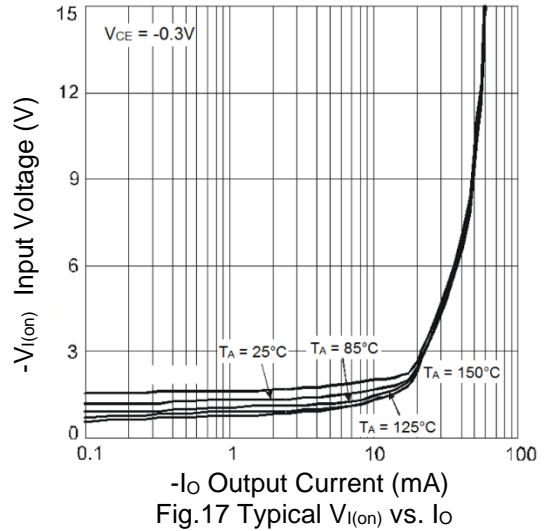
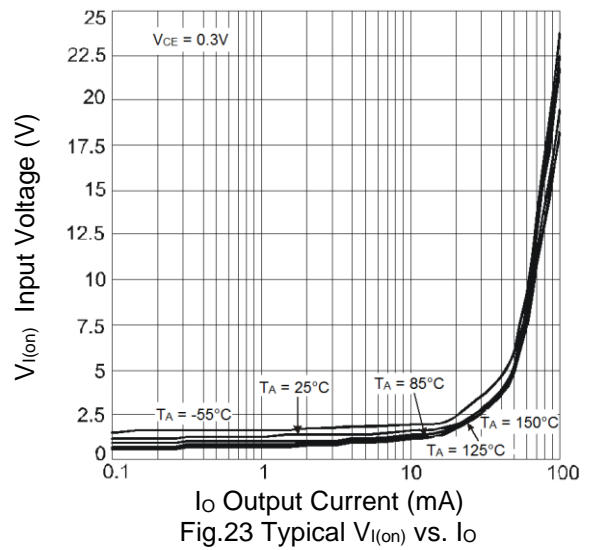
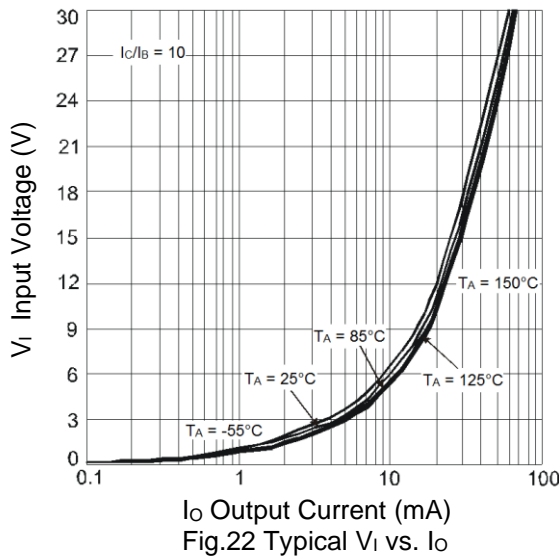
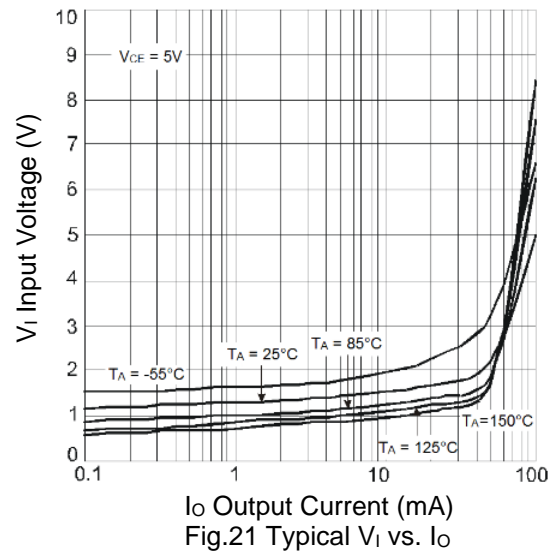
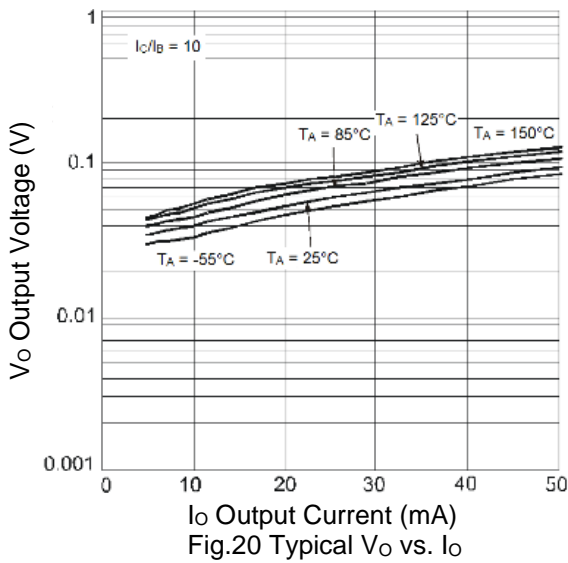
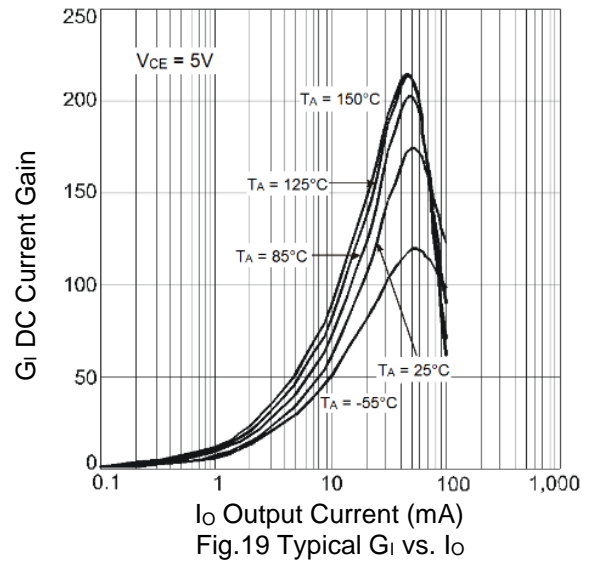
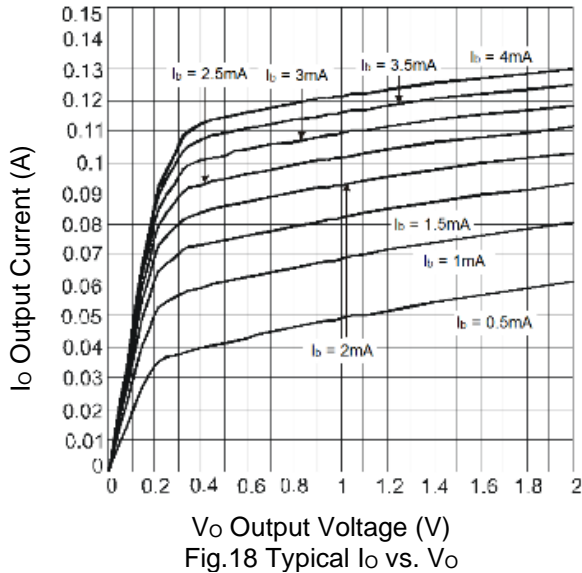

Fig.17 Typical  $V_{i(on)}$  vs.  $I_o$

**Typical Curves – DCX143EU NPN Section** (@  $T_A = +25^\circ\text{C}$ , unless otherwise specified.)



**Typical Curves – DCX114TU PNP Section** (@  $T_A = +25^\circ\text{C}$ , unless otherwise specified.)

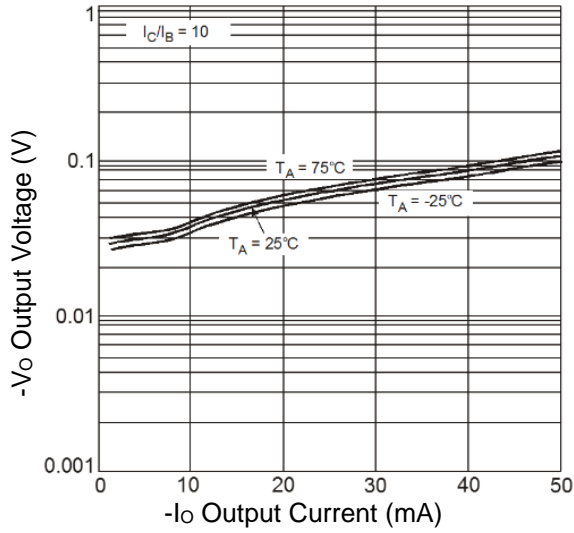

Fig.24 Typical  $V_O$  vs.  $I_o$

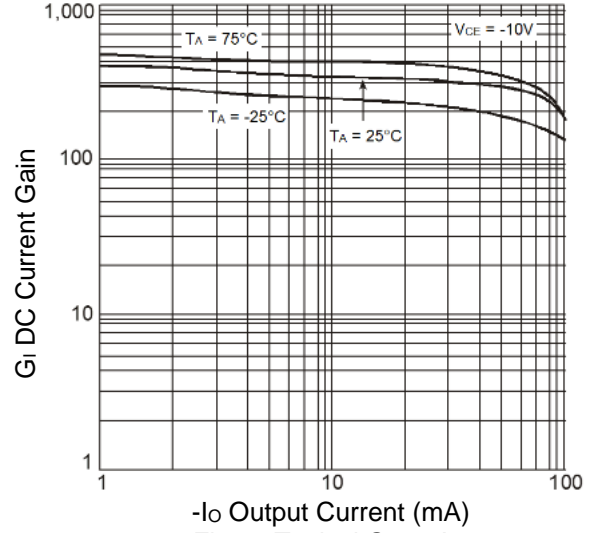

Fig.25 Typical  $G_1$  vs.  $I_o$

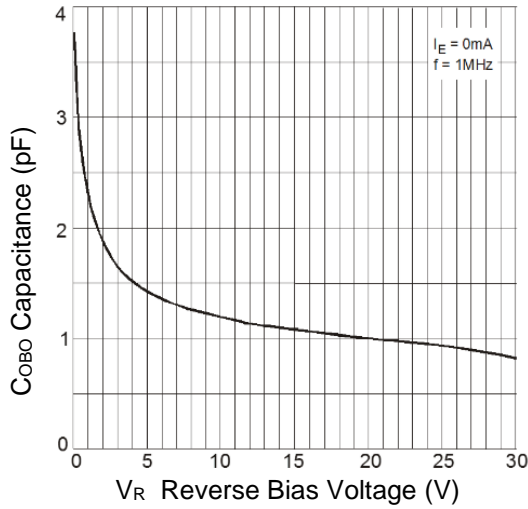

Fig.26 Typical  $C_{OBO}$  vs.  $V_R$

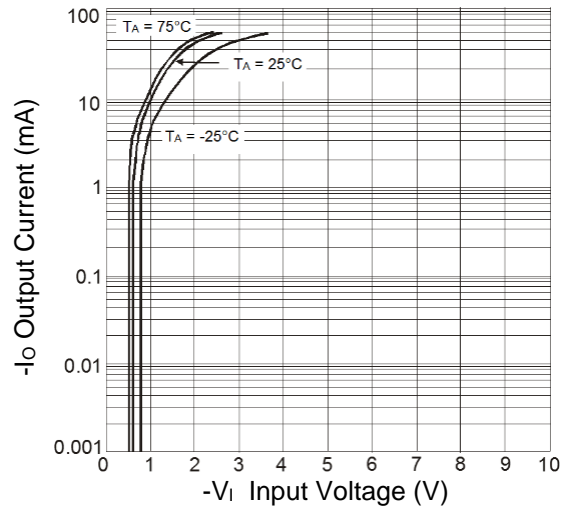

Fig.27 Typical  $I_o$  vs.  $V_I$

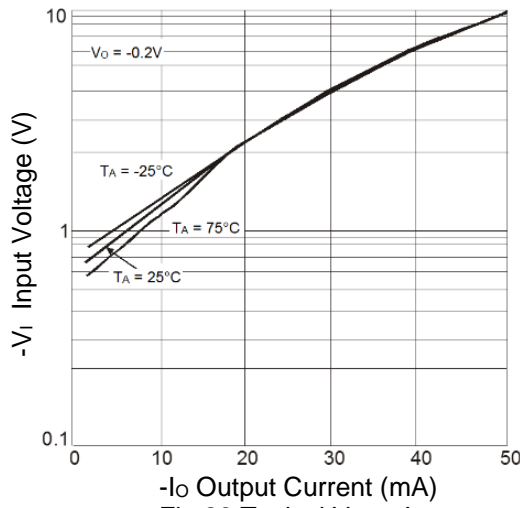
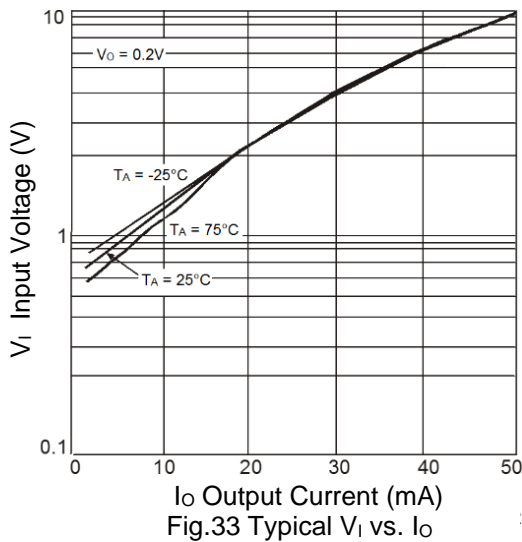
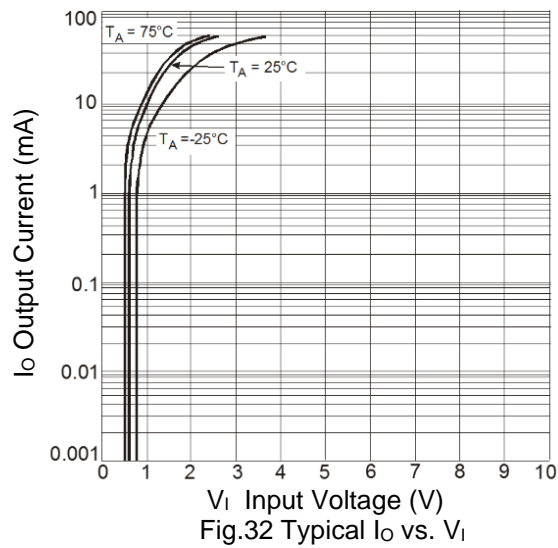
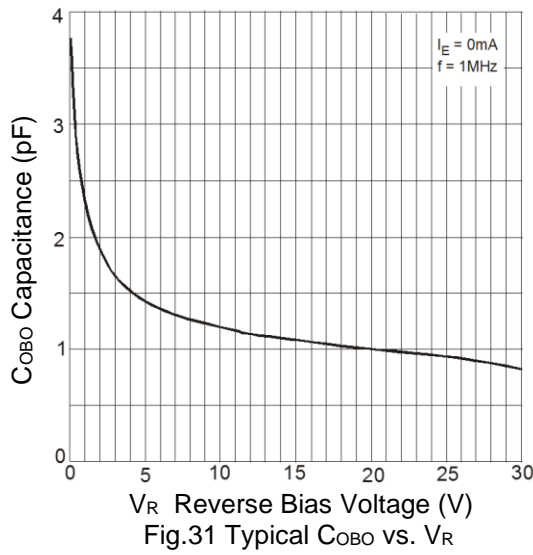
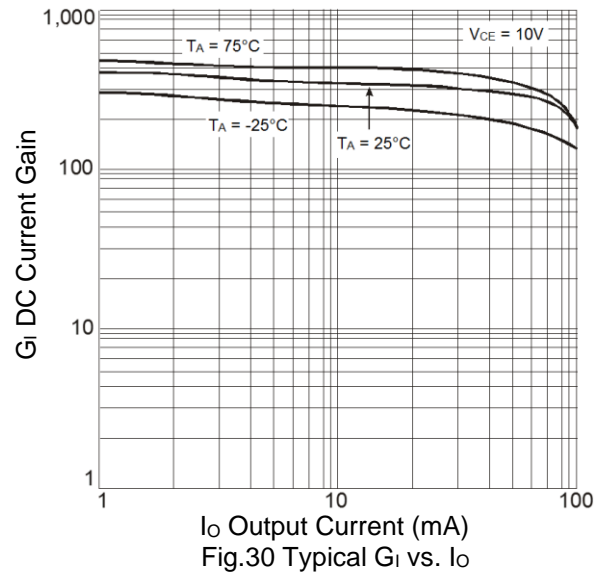
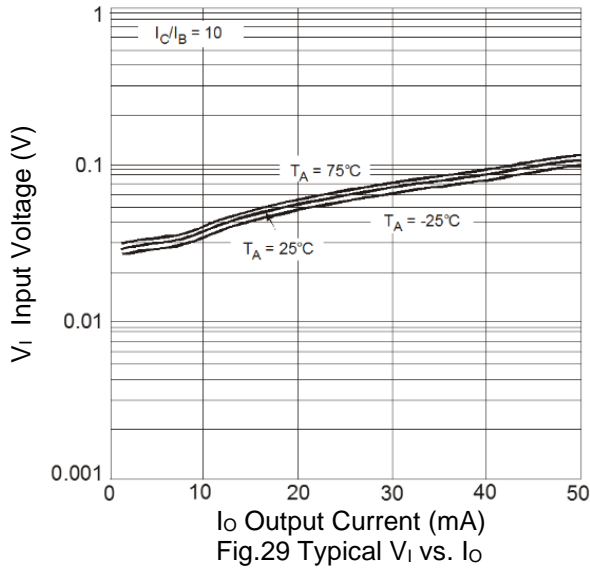

Fig.28 Typical  $V_I$  vs.  $I_o$

**Typical Curves – DCX114TU NPN Section** (@  $T_A = +25^\circ\text{C}$ , unless otherwise specified.)



**Package Outline Dimensions**

Please see <http://www.diodes.com/package-outlines.html> for the latest version.

SOT363

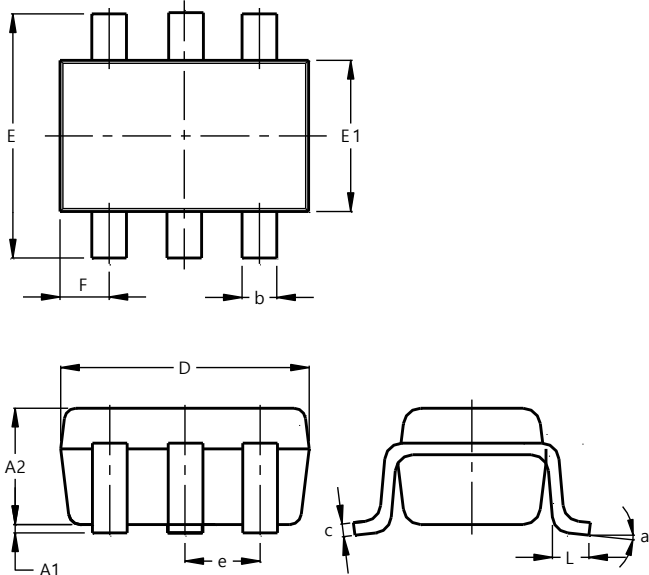

SOT363			
Dim	Min	Max	Typ
A1	0.00	0.10	0.05
A2	0.90	1.00	0.95
b	0.10	0.30	0.25
c	0.10	0.22	0.11
D	1.80	2.20	2.15
E	2.00	2.20	2.10
E1	1.15	1.35	1.30
e	0.650 BSC		
F	0.40	0.45	0.425
L	0.25	0.40	0.30
a	0°	8°	--
All Dimensions in mm			

**Suggested Pad Layout**

Please see <http://www.diodes.com/package-outlines.html> for the latest version.

SOT363

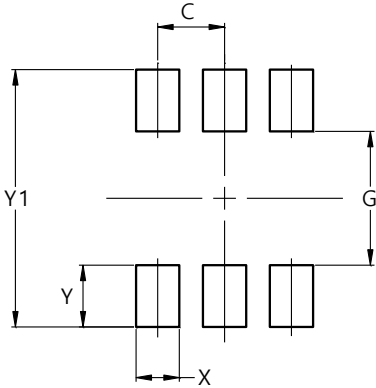

Dimensions	Value (in mm)
C	0.650
G	1.300
X	0.420
Y	0.600
Y1	2.500

**IMPORTANT NOTICE**

1. DIODES INCORPORATED (Diodes) AND ITS SUBSIDIARIES MAKE NO WARRANTY OF ANY KIND, EXPRESS OR IMPLIED, WITH REGARDS TO ANY INFORMATION CONTAINED IN THIS DOCUMENT, INCLUDING, BUT NOT LIMITED TO, THE IMPLIED WARRANTIES OF MERCHANTABILITY, FITNESS FOR A PARTICULAR PURPOSE OR NON-INFRINGEMENT OF THIRD PARTY INTELLECTUAL PROPERTY RIGHTS (AND THEIR EQUIVALENTS UNDER THE LAWS OF ANY JURISDICTION).
2. The Information contained herein is for informational purpose only and is provided only to illustrate the operation of Diodes' products described herein and application examples. Diodes does not assume any liability arising out of the application or use of this document or any product described herein. This document is intended for skilled and technically trained engineering customers and users who design with Diodes' products. Diodes' products may be used to facilitate safety-related applications; however, in all instances customers and users are responsible for (a) selecting the appropriate Diodes products for their applications, (b) evaluating the suitability of Diodes' products for their intended applications, (c) ensuring their applications, which incorporate Diodes' products, comply the applicable legal and regulatory requirements as well as safety and functional-safety related standards, and (d) ensuring they design with appropriate safeguards (including testing, validation, quality control techniques, redundancy, malfunction prevention, and appropriate treatment for aging degradation) to minimize the risks associated with their applications.
3. Diodes assumes no liability for any application-related information, support, assistance or feedback that may be provided by Diodes from time to time. Any customer or user of this document or products described herein will assume all risks and liabilities associated with such use, and will hold Diodes and all companies whose products are represented herein or on Diodes' websites, harmless against all damages and liabilities.
4. Products described herein may be covered by one or more United States, international or foreign patents and pending patent applications. Product names and markings noted herein may also be covered by one or more United States, international or foreign trademarks and trademark applications. Diodes does not convey any license under any of its intellectual property rights or the rights of any third parties (including third parties whose products and services may be described in this document or on Diodes' website) under this document.
5. Diodes' products are provided subject to Diodes' Standard Terms and Conditions of Sale (<https://www.diodes.com/about/company/terms-and-conditions/terms-and-conditions-of-sales/>) or other applicable terms. This document does not alter or expand the applicable warranties provided by Diodes. Diodes does not warrant or accept any liability whatsoever in respect of any products purchased through unauthorized sales channel.
6. Diodes' products and technology may not be used for or incorporated into any products or systems whose manufacture, use or sale is prohibited under any applicable laws and regulations. Should customers or users use Diodes' products in contravention of any applicable laws or regulations, or for any unintended or unauthorized application, customers and users will (a) be solely responsible for any damages, losses or penalties arising in connection therewith or as a result thereof, and (b) indemnify and hold Diodes and its representatives and agents harmless against any and all claims, damages, expenses, and attorney fees arising out of, directly or indirectly, any claim relating to any noncompliance with the applicable laws and regulations, as well as any unintended or unauthorized application.
7. While efforts have been made to ensure the information contained in this document is accurate, complete and current, it may contain technical inaccuracies, omissions and typographical errors. Diodes does not warrant that information contained in this document is error-free and Diodes is under no obligation to update or otherwise correct this information. Notwithstanding the foregoing, Diodes reserves the right to make modifications, enhancements, improvements, corrections or other changes without further notice to this document and any product described herein. This document is written in English but may be translated into multiple languages for reference. Only the English version of this document is the final and determinative format released by Diodes.
8. Any unauthorized copying, modification, distribution, transmission, display or other use of this document (or any portion hereof) is prohibited. Diodes assumes no responsibility for any losses incurred by the customers or users or any third parties arising from any such unauthorized use.
9. This Notice may be periodically updated with the most recent version available at <https://www.diodes.com/about/company/terms-and-conditions/important-notice>

The Diodes logo is a registered trademark of Diodes Incorporated in the United States and other countries.  
All other trademarks are the property of their respective owners.  
© 2024 Diodes Incorporated. All Rights Reserved.

[www.diodes.com](http://www.diodes.com)

## Looking for pricing, stock, or lifecycle information?

Click below to explore more details on WIN SOURCE:

 [View DCX124EU-7 on WIN SOURCE](#)

 [Diodes Incorporated](#) Information

## Optimize Your Supply Chain with WIN SOURCE Solutions

-  Global Sourcing Solution
-  Obsolete Management
-  Cost Control Management
-  Shortage Management
-  Alternative Solution
-  Excess Inventory Management