

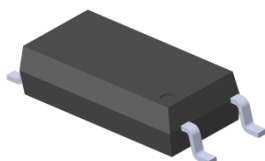

**THE DATASHEET OF  
EL1010(TA)-VG**



## 4 PIN LONG CREEPAGE SOP PHOTOTRANSISTOR PHOTOCOUPLER EL101X-G Series



Schematic

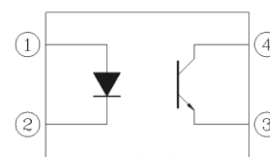

Pin Configuration

1. Anode
2. Cathode
3. Emitter
4. Collector

### Features:

- Compliance Halogen Free  
(Br < 900 ppm, Cl < 900 ppm, Br + Cl < 1500 ppm)
- Current transfer ratio  
(CTR: 50~600% at  $I_F = 5\text{mA}$ ,  $V_{CE} = 5\text{V}$ )  
(CTR: 63~320% at  $I_F = 10\text{mA}$ ,  $V_{CE} = 5\text{V}$ )
- High isolation voltage between input and output (Viso =5000 V rms )
- Compact 4 Pin SOP with a 2.0 mm profile
- Compliance with EU REACH
- 8mm long creepage distance
- The product itself will remain within RoHS compliant version
- UL and cUL approved (No. E214129)
- VDE approved (No. 40028391)
- SEMKO approved
- NEMKO approved
- DEMKO approved
- FIMKO approved
- CQC approved

### Description

The EL101X-G series devices consist of an infrared emitting diode, optically coupled to a phototransistor detector.

Compound use free halogens and  $\text{Sb}_2\text{O}_3$ .

They are packaged in a 4-pin SOP package

### Applications

- Programmable controllers
- System appliances, measuring instruments
- Telecommunication equipments
- Home appliances, such as fan heaters, etc.
- Signal transmission between circuits of different potentials and impedances

**Absolute Maximum Ratings (Ta=25°C)**

	Parameter	Symbol	Rating	Unit
Input	Forward current	I <sub>F</sub>	60	mA
	Peak forward current (1us, pulse)	I <sub>FP</sub>	1.5	A
	Reverse voltage	V <sub>R</sub>	6	V
	Power dissipation	P <sub>D</sub>	100	mW
Output	Power dissipation	P <sub>C</sub>	150	mW
	Collector current	I <sub>C</sub>	50	mA
	Collector-Emitter voltage	V <sub>CEO</sub>	80	V
	Emitter-Collector voltage	V <sub>ECO</sub>	7	V
Total Power Dissipation		P <sub>TOT</sub>	250	mW
Isolation Voltage* <sup>1</sup>		V <sub>ISO</sub>	5000	V <sub>rms</sub>
Operating Temperature		T <sub>OPR</sub>	-55 to 110	°C
Storage Temperature		T <sub>STG</sub>	-55 to 125	°C
Soldering Temperature* <sup>2</sup>		T <sub>SOL</sub>	260	°C

Notes

\*1 AC for 1 minute, R.H.= 40 ~ 60% R.H. In this test, pins 1, 2 are shorted together, and pins 3, 4 are shorted together.

\*2 For 10 seconds

**Electro-Optical Characteristics (Ta=25°C unless specified otherwise)**

**Input**

Parameter	Symbol	Min.	Typ.	Max.	Unit	Condition
Forward Voltage	$V_F$	-	1.45	1.5	V	$I_F = 50\text{mA}$
Reverse current	$I_R$	-	-	10	$\mu\text{A}$	$V_R = 6\text{V}$
Input capacitance	$C_{in}$	-	50	-	pF	$V = 0, f = 1\text{kHz}$

**Output**

Parameter	Symbol	Min	Typ.	Max.	Unit	Condition
Collector-Emitter dark current	$I_{CEO}$	-	-	100	nA	$V_{CE} = 20\text{V}, I_F = 0\text{mA}$
Collector-Emitter breakdown voltage	$BV_{CEO}$	80	-	-	V	$I_C = 0.1\text{mA}$
Emitter-Collector breakdown voltage	$BV_{ECO}$	7	-	-	V	$I_E = 0.1\text{mA}$

**Transfer Characteristics**

Parameter	Symbol	Min	Typ.	Max.	Unit	Condition
Current Transfer ratio	EL1010	50	-	600	%	$I_F = 5\text{mA}, V_{CE} = 5\text{V}$
	EL1017	80	-	160		
	EL1018	130	-	260		
	EL1019	200	-	400		
	EL1012	63	-	125	%	$I_F = 10\text{mA}, V_{CE} = 5\text{V}$
	EL1013	100	-	200		
	EL1014	160	-	320		
	EL1012	22	-	-		
	EL1013	34	-	-		
	EL1014	56	-	-		
Collector-Emitter saturation voltage	$V_{CE(sat)}$	-	-	0.3	V	$I_F = 10\text{mA}, I_C = 1\text{mA}$
Isolation resistance	$R_{IO}$	$5 \times 10^{10}$	-	-	$\Omega$	$V_{IO} = 500\text{Vdc}, 40\sim 60\% \text{ R.H.}$
Floating capacitance	$C_{IO}$	-	-	1.0	pF	$V_{IO} = 0, f = 1\text{MHz}$

**Transfer Characteristics**

Parameter	Symbol	Min	Typ. *	Max.	Unit	Condition
Turn on time	Ton	-	4	-	μs	V <sub>CE</sub> = 5V, I <sub>C</sub> = 5mA, R <sub>L</sub> = 100Ω
Turn off time	Toff	-	3	-		
Rise time	t <sub>r</sub>	-	-	18	μs	V <sub>CE</sub> = 5V, I <sub>C</sub> = 5mA, R <sub>L</sub> = 100Ω
Fall time	t <sub>f</sub>	-	-	18		

\* Typical values at T<sub>a</sub> = 25°C

EVERLIGHT

Typical Electro-Optical Characteristics Curves

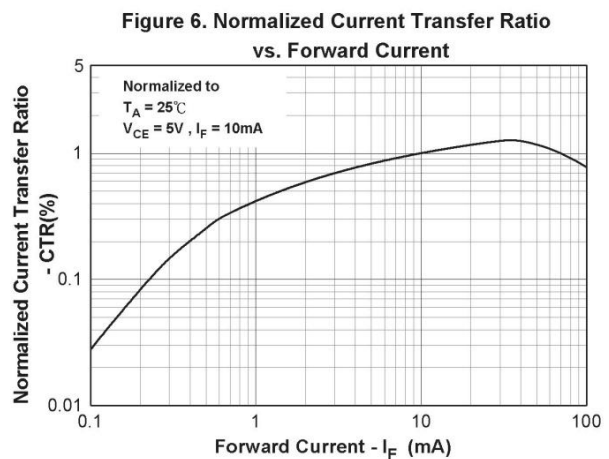
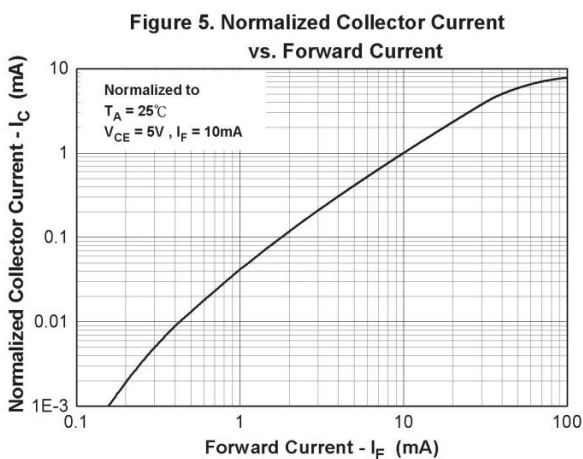
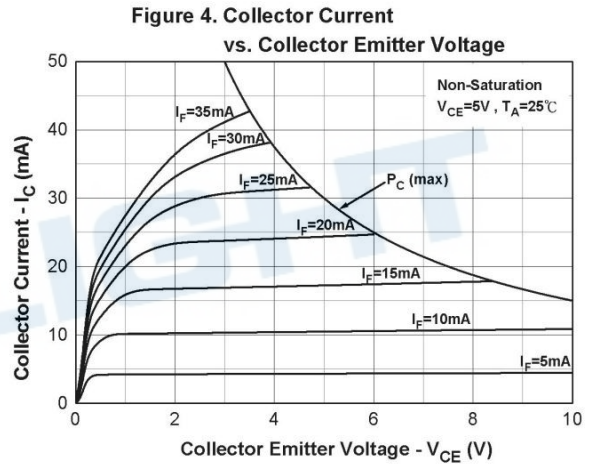
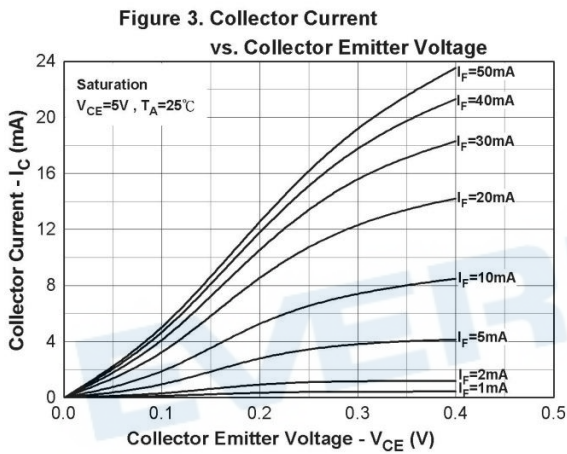
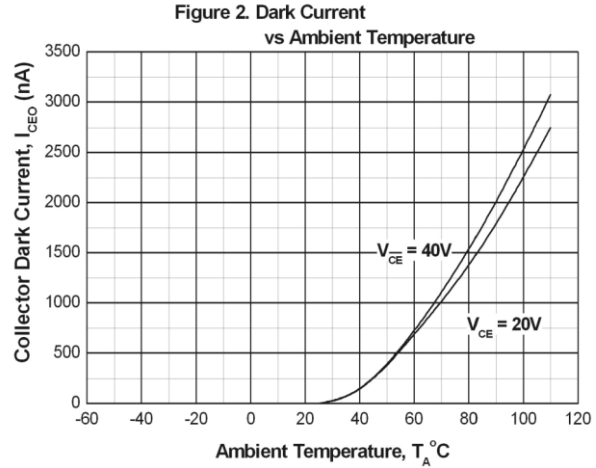
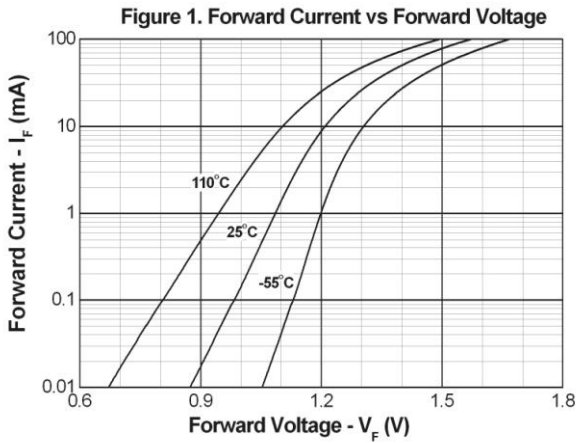

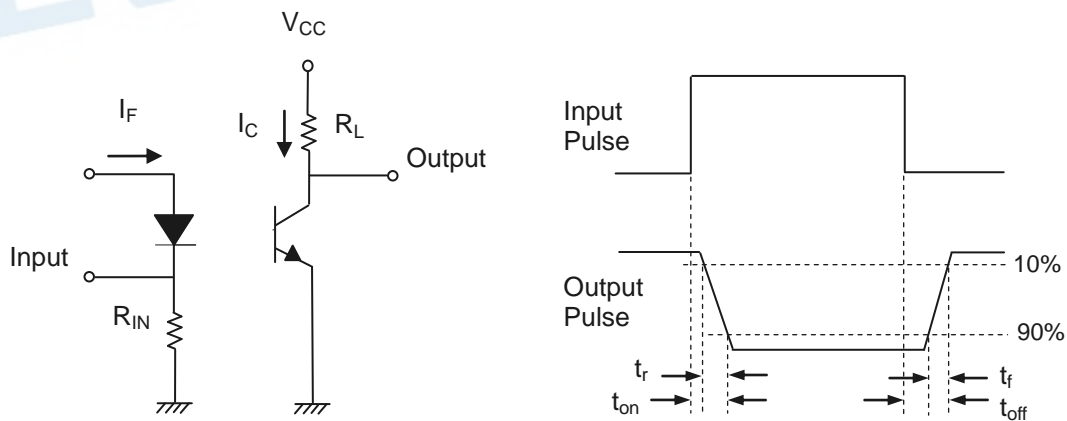
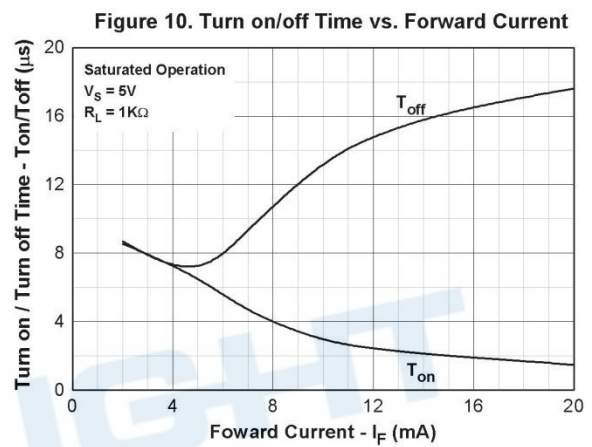
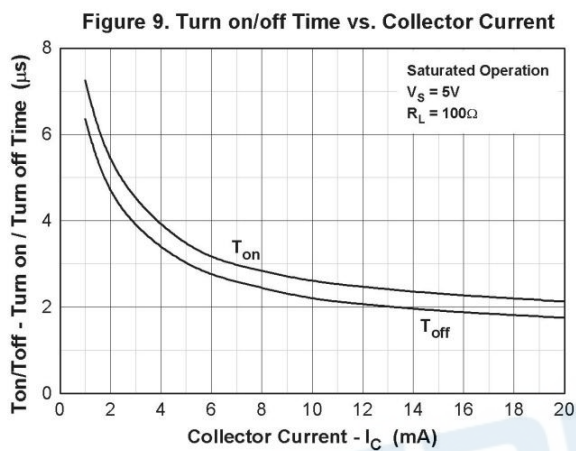
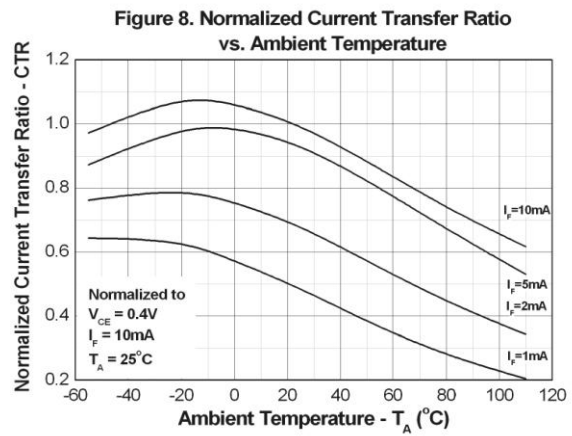
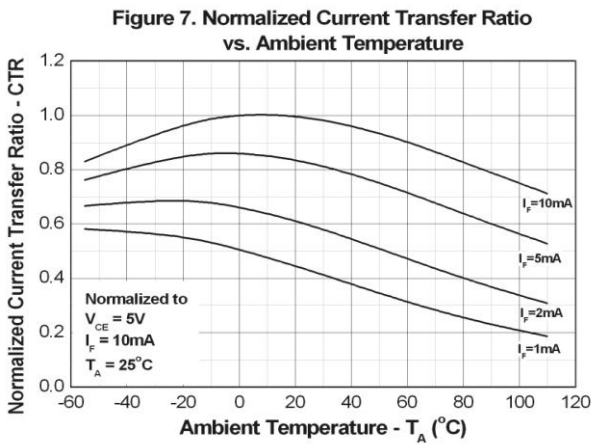

Figure 11. Switching Time Test Circuit & Waveforms

## Order Information

### Part Number

**EL101X(Y)-VG**

### Notes

EL101 = Part No.  
X = CTR Rank (0, 2, 3, 4, 7, 8 or 9)  
Y = Tape and reel option (TA, TB or none)  
V = VDE safety (optional)  
G = Halogens free

Option	Description	Packing quantity
None	Standard SMD option	100 units per tube
-V	Standard SMD option + VDE	100 units per tube
(TA)	TA Tape & reel option	3000 units per reel
(TB)	TB Tape & reel option	3000 units per reel
(TA)-V	TA Tape & reel option + VDE	3000 units per reel
(TB)-V	TB Tape & reel option + VDE	3000 units per reel

**Package Dimension (Dimensions in mm)**

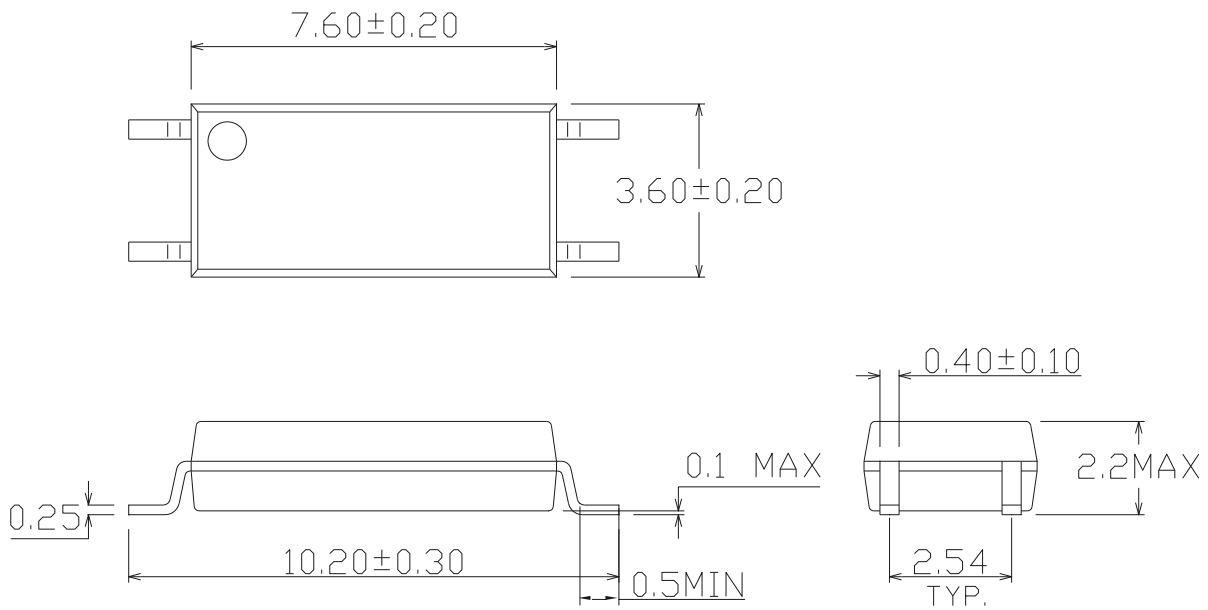

**Recommended pad layout for surface mount leadform**

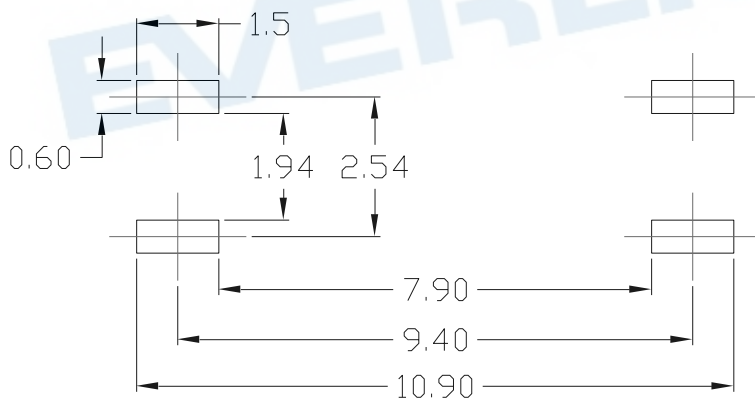

**Notes**

Suggested pad dimension is just for reference only.  
 Please modify the pad dimension based on individual need.

## Device Marking

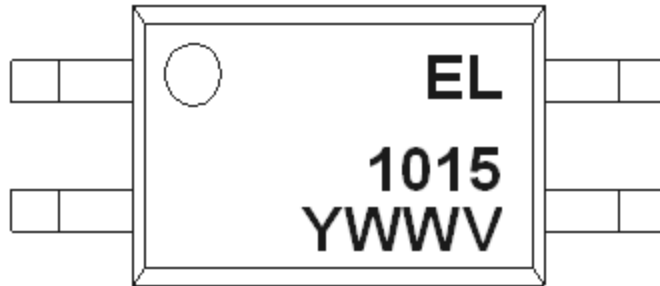

## Notes

EL	denotes Everlight
1015	denotes Device Number
Y	denotes 1 digit Year code
WW	denotes 2 digit Week code
V	denotes VDE (optional)

EVERLIGHT

**Tape & Reel Packing Specifications**

**Option TA**

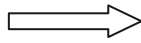
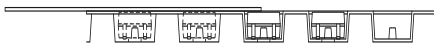
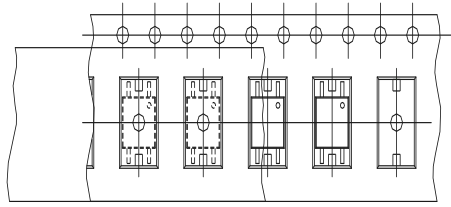

Direction of feed from reel

**Option TB**

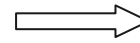
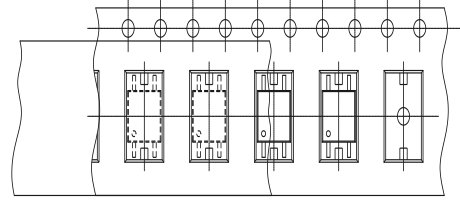

Direction of feed from reel

**Tape dimensions**

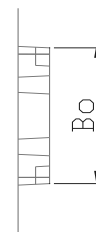
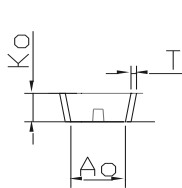
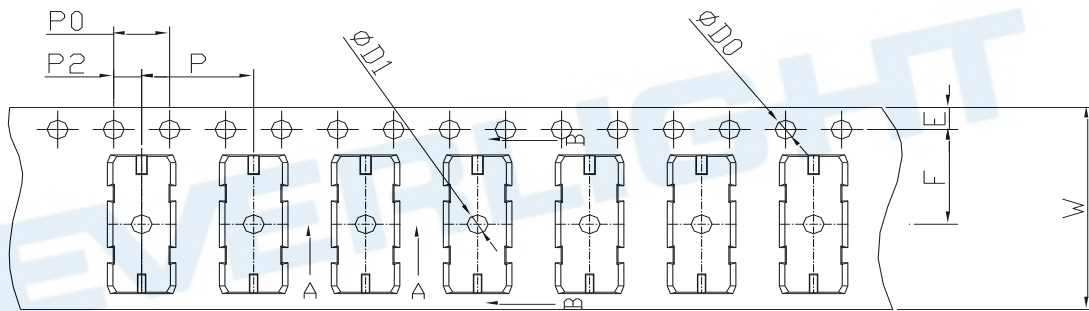

Dimension No.	<b>Ao</b>	<b>Bo</b>	<b>Do</b>	<b>D1</b>	<b>E</b>	<b>F</b>
Dimension (mm)	3.9 ± 0.10	10.82 ± 0.10	1.5 ± 0.10	1.5 ± 0.10	1.75 ± 0.10	7.5 ± 0.10
Dimension No.	<b>Po</b>	<b>P</b>	<b>P2</b>	<b>T</b>	<b>W</b>	<b>Ko</b>
Dimension (mm)	4.0 ± 0.10	8.0 ± 0.10	2.0 ± 0.10	0.4 ± 0.05	16.0 ± 0.30	2.25 ± 0.10

**Precautions for Use**

1. Soldering Condition

1.1 (A) Maximum Body Case Temperature Profile for evaluation of Reflow Profile

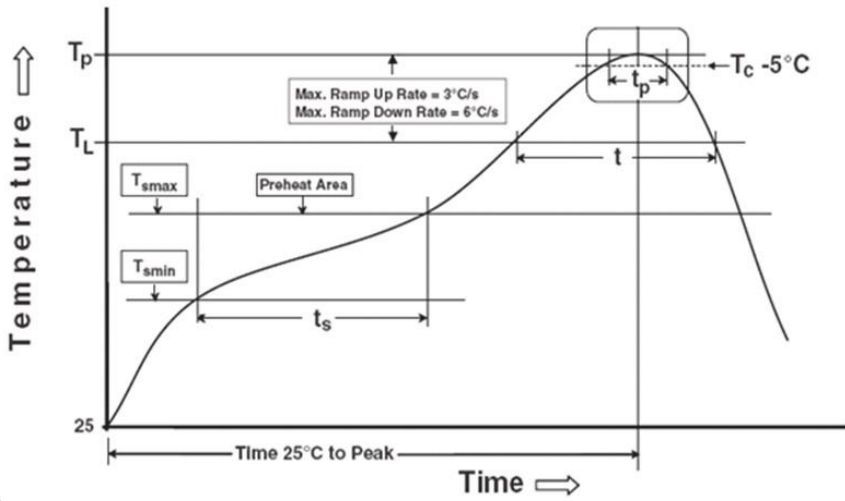

Notes

Reference: IPC/JEDEC J-STD-020D

**Preheat**

Temperature min ( $T_{smin}$ )	150 °C
Temperature max ( $T_{smax}$ )	200°C
Time ( $T_{smin}$ to $T_{smax}$ ) ( $t_s$ )	60-120 seconds
Average ramp-up rate ( $T_{smax}$ to $T_p$ )	3 °C/second max

**Other**

Liquidus Temperature ( $T_L$ )	217 °C
Time above Liquidus Temperature ( $t_L$ )	60-100 sec
Peak Temperature ( $T_p$ )	260°C
Time within 5 °C of Actual Peak Temperature: $T_p - 5^\circ\text{C}$	30 s
Ramp- Down Rate from Peak Temperature	6°C /second max.
Time 25°C to peak temperature	8 minutes max.
Reflow times	3 times

## DISCLAIMER

1. Above specification may be changed without notice. EVERLIGHT will reserve authority on material change for above specification.
2. The graphs shown in this datasheet are representing typical data only and do not show guaranteed values.
3. When using this product, please observe the absolute maximum ratings and the instructions for use outlined in these specification sheets. EVERLIGHT assumes no responsibility for any damage resulting from use of the product which does not comply with the absolute maximum ratings and the instructions included in these specification sheets.
4. These specification sheets include materials protected under copyright of EVERLIGHT. Reproduction in any form is prohibited without the specific consent of EVERLIGHT.
5. This product is not intended to be used for military, aircraft, automotive, medical, life sustaining or life saving applications or any other application which can result in human injury or death. Please contact authorized Everlight sales agent for special application request.
6. Statements regarding the suitability of products for certain types of applications are based on Everlight's knowledge of typical requirements that are often placed on Everlight products in generic applications. Such statements are not binding statements about the suitability of products for a particular application. It is the customer's responsibility to validate that a particular product with the properties described in the product specification is suitable for use in a particular application. Parameters provided in datasheets and/or specifications may vary in different applications and performance may vary over time. All operating parameters, including typical parameters, must be validated for each customer application by the customer's technical experts. Product specifications do not expand or otherwise modify Everlight's terms and conditions of purchase, including but not limited to the warranty expressed therein.

## Looking for pricing, stock, or lifecycle information?

Click below to explore more details on WIN SOURCE:

- ⊖ [View EL1010\(TA\)-VG on WIN SOURCE](#)
- ⊖ [Everlight Electronics Co Ltd Information](#)

## Optimize Your Supply Chain with WIN SOURCE Solutions

- ✓ Global Sourcing Solution
- ✓ Obsolete Management
- ✓ Cost Control Management
- ✓ Shortage Management
- ✓ Alternative Solution
- ✓ Excess Inventory Management