



**THE DATASHEET OF  
ADM6710QARJZ-REEL7**



## FEATURES

- Accurate monitoring of up to four power supply voltages
- 5 factory set threshold options: 1.8 V, 2.5 V, 3.0 V, 3.3 V, 5 V
- Adjustable input threshold voltage = 0.62 V (1.5% accuracy)
- 200 ms typical reset timeout
- Open-drain RESET output (10  $\mu$ A internal pull-up)
- Reset output stage: active low, valid to  $IN_1 = 1$  V or  $IN_2 = 1$  V
- Low power consumption (35  $\mu$ A)
- Power supply glitch immunity
- Specified from  $-40^{\circ}\text{C}$  to  $+125^{\circ}\text{C}$
- 6-lead SOT-23 package

## APPLICATIONS

- Telecommunications
- Microprocessor systems
- Desktop and notebook computers
- Data storage equipment
- Servers/workstations

## GENERAL DESCRIPTION

The [ADM6710](#) is a low voltage, high accuracy supervisory circuit. The device monitors up to four system supply voltages.

The [ADM6710](#) incorporates a variety of internally pretrimmed undervoltage threshold options for monitoring 1.8 V, 2.5 V, 3.0 V, 3.3 V and 5.0 V supply voltages. The [ADM6710Q](#) offers three adjustable thresholds for monitoring voltages down to 0.62 V. See the Ordering Guide section for a list and description of all available options.

If a monitored power supply voltage falls below the minimum voltage threshold, a single active low output asserts, triggering a system reset. The output is open-drain with a weak internal pull-up to the monitored  $IN_2$  supply (or to  $V_{CC}$  in the case of the

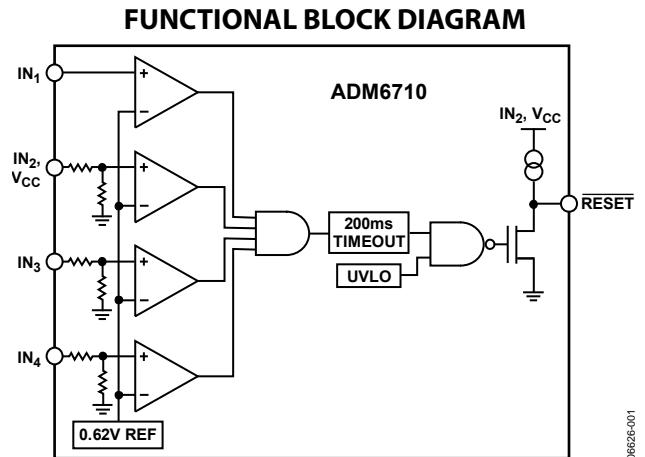

Figure 1.

[ADM6710Q](#)) of typically 10  $\mu$ A. After all voltages rise above the selected threshold level, the reset signal remains low for the reset timeout period (200 ms typical).

The [ADM6710](#) output remains valid as long as  $IN_1$  or  $IN_2$  exceeds 1 V, whereas for the [ADM6710Q](#), the output remains valid as long as  $V_{CC}$  exceeds 2 V.

Unused monitored inputs must not be allowed to float or to be grounded, instead they must be connected to a supply voltage greater than their specified threshold voltages.

The [ADM6710](#) is available in a 6-lead SOT-23 package. The device operates over the extended temperature range of  $-40^{\circ}\text{C}$  to  $+125^{\circ}\text{C}$ .

## TABLE OF CONTENTS

Features .....	1	Typical Performance Characteristics .....	6
Applications .....	1	Theory of Operation .....	8
Functional Block Diagram .....	1	Input Configuration .....	8
General Description .....	1	RESET Output Configuration .....	8
Revision History .....	2	Addition Of Manual Reset .....	8
Specifications .....	3	Outline Dimensions .....	9
Absolute Maximum Ratings .....	4	Ordering Guide .....	9
ESD Caution .....	4		
Pin Configurations and Function Descriptions .....	5		

## REVISION HISTORY

### 11/15—Rev. A to Rev. B

Changes to Features Section and General Description Section .....	1
Changes to Operating Voltage Range, $V_{IN2}$ Parameter and RESET Output Low ( $V_{OL}$ ) Parameter, Table 1 .....	3
Change to Storage Temperature Range Parameter and Operating Temperature Range Parameter, Table 2 .....	4
Changes to Figure 4, Figure 6, and Figure 9 .....	6
Updated Outline Dimensions .....	9
Changes to Ordering Guide .....	9

### 10/10—Rev. 0 to Rev. A

Added Figure 17 .....	9
-----------------------	---

### 6/07—Revision 0: Initial Version

## SPECIFICATIONS

$V_{IN2} = 1\text{ V to }5.5\text{ V}$ ,  $T_A = -40^\circ\text{C to }+125^\circ\text{C}$ , unless otherwise noted. Typical values are  $V_{IN2} = 3.0\text{ V to }3.3\text{ V}$ ,  $T_A = 25^\circ\text{C}$ .

Table 1.

Parameter	Min	Typ	Max	Units	Test Conditions/Comments
OPERATING VOLTAGE RANGE					
$V_{CC}^1$	2.0		5.5	V	ADM6710Q only
$V_{IN2}^2$	1.0		5.5	V	All devices except ADM6710Q; $T_A = 0^\circ\text{C to }+125^\circ\text{C}$
	1.2		5.5	V	All devices except ADM6710Q; $T_A = -40^\circ\text{C to }+125^\circ\text{C}$
INPUT CURRENT					
$IN_x$ Input Current		25	40	$\mu\text{A}$	$IN_x$ = nominal input voltage (for 1.8 V, 2.5 V and 5.0 V supplies)
		55	115	$\mu\text{A}$	$IN_2$ = nominal input voltage (for 3.0 V and 3.3 V supplies); the supply splits into 25 $\mu\text{A}$ for the resistor divider and 30 $\mu\text{A}$ for other circuits
			0.4	$\mu\text{A}$	$V_{IN1} = 0\text{ V to }0.85\text{ V}$ (for adjustable thresholds)
			0.2	$\mu\text{A}$	$V_{IN3}, V_{IN4} = 0\text{ V to }0.85\text{ V}$ (for adjustable thresholds)
$I_{CC}$ Input Current		35	50	$\mu\text{A}$	ADM6710Q only; $V_{CC} = 5.5\text{ V}$
THRESHOLD VOLTAGE					
Threshold Voltage ( $V_{TH}$ )	4.50	4.63	4.75	V	$IN_x$ decreasing; 5 V (–5%)
	4.25	4.38	4.50	V	$IN_x$ decreasing; 5 V (–10%)
	3.00	3.08	3.15	V	$IN_x$ decreasing; 3.3 V (–5%)
	2.85	2.93	3.00	V	$IN_x$ decreasing; 3.3 V (–10%)
	2.70	2.78	2.85	V	$IN_x$ decreasing; 3.0 V (–5%)
	2.55	2.63	2.70	V	$IN_x$ decreasing; 3.0 V (–10%)
	2.25	2.32	2.38	V	$IN_x$ decreasing; 2.5 V (–5%)
	2.13	2.19	2.25	V	$IN_x$ decreasing; 2.5 V (–10%)
	1.62	1.67	1.71	V	$IN_x$ decreasing; 1.8 V (–5%)
	1.53	1.58	1.62	V	$IN_x$ decreasing; 1.8 V (–10%)
Adjustable Threshold ( $V_{TH}$ )	0.611	0.620	0.629	V	$IN_x$ decreasing
RESET THRESHOLD HYSTERESIS ( $V_{HYST}$ )		0.3		$\%V_{TH}$	$IN_x$ increasing relative to $IN_x$ decreasing
RESET THRESHOLD TEMPERATURE COEFFICIENT ( $TCV_{TH}$ )		60		ppm/ $^\circ\text{C}$	
$IN_x$ to RESET DELAY ( $t_{RP}$ )		30		$\mu\text{s}$	$V_{IN}$ falling at 10 mV/ $\mu\text{s}$ from $V_{TH}$ to $V_{TH} - 50\text{ mV}$
RESET TIMEOUT PERIOD ( $t_{RP}$ )	140	200	280	ms	
RESET OUTPUT LOW ( $V_{OL}$ )			0.3	V	$V_{IN2}, V_{CC} = 5\text{ V}, I_{SINK} = 2\text{ mA}$
			0.4	V	$V_{IN2}, V_{CC} = 2.5\text{ V}, I_{SINK} = 1.2\text{ mA}$
			0.3	V	$V_{IN2} = 1.0, I_{SINK} = 20\text{ }\mu\text{A}, T_A = 0^\circ\text{C to }+125^\circ\text{C}$
RESET OUTPUT HIGH ( $V_{OH}$ )	$0.8 \times V_{CC}$			V	$V_{CC} \geq 2.0\text{ V}, I_{SOURCE} = 4\text{ }\mu\text{A}, \overline{\text{RESET}}$ deasserted (ADM6710Q only)
	$0.8 \times V_{IN2}$			V	$V_{IN2} \geq 2.0\text{ V}, I_{SOURCE} = 4\text{ }\mu\text{A}, \overline{\text{RESET}}$ deasserted
RESET OUTPUT HIGH SOURCE CURRENT ( $I_{OH}$ )		10		$\mu\text{A}$	$V_{IN2} \geq 2.0\text{ V}, \overline{\text{RESET}}$ deasserted

<sup>1</sup> Note that the ADM6710Q is powered from  $V_{CC}$ .

<sup>2</sup> The RESET output is guaranteed to be in the correct state for  $IN_1$  or  $IN_2$  down to 1 V.

## ABSOLUTE MAXIMUM RATINGS

Table 2.

Parameter	Rating
$V_{CC}$ , $IN_x$ , $\overline{RESET}$ to GND	-0.3 V to +6 V
Continuous $\overline{RESET}$ Current	20 mA
Storage Temperature Range	-65°C to +150°C
Operating Temperature Range	-40°C to +125°C
Lead Temperature (10 sec)	300°C
Junction Temperature	135°C

Stresses at or above those listed under Absolute Maximum Ratings may cause permanent damage to the product. This is a stress rating only; functional operation of the product at these or any other conditions above those indicated in the operational section of this specification is not implied. Operation beyond the maximum operating conditions for extended periods may affect product reliability.

Table 3. Thermal Resistance

Package Type	$\theta_{JA}$	Unit
6-lead SOT-23	169.5	°C/W

### ESD CAUTION



**ESD (electrostatic discharge) sensitive device.** Charged devices and circuit boards can discharge without detection. Although this product features patented or proprietary protection circuitry, damage may occur on devices subjected to high energy ESD. Therefore, proper ESD precautions should be taken to avoid performance degradation or loss of functionality.

## PIN CONFIGURATIONS AND FUNCTION DESCRIPTIONS

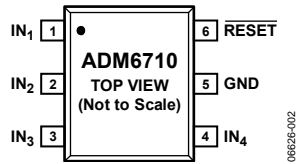

Figure 2. ADM6710 Pin Configuration

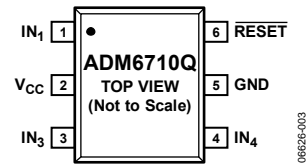

Figure 3. ADM6710Q Pin Configuration

Table 4. Pin Function Descriptions

Pin No.	Mnemonic	Description
1	IN <sub>1</sub>	Input Voltage 1.
2	IN <sub>2</sub>	Input Voltage 2. IN <sub>2</sub> is the power supply input for the ADM6710.
	V <sub>CC</sub>	V <sub>CC</sub> is the power supply input for the ADM6710Q. It is not a monitored input.
3	IN <sub>3</sub>	Input Voltage 3.
4	IN <sub>4</sub>	Input Voltage 4.
5	GND	Ground.
6	RESET	Active Low RESET Output. RESET goes low when an input drops below the specified threshold. Once all inputs rise above the threshold voltage, RESET remains low for 200 ms (typical) before going high. RESET is open drain with a weak internal pull-up to IN <sub>2</sub> or, in the case of the ADM6710Q, to V <sub>CC</sub> , typically 10 μA.

# TYPICAL PERFORMANCE CHARACTERISTICS

$V_{IN2} = V_{CC} = 3.0V$ ,  $T_A = 25^\circ C$ , unless otherwise noted.

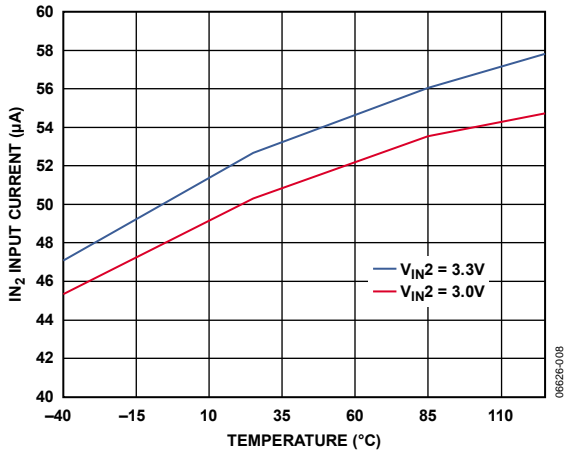

Figure 4.  $I_{N2}$  Input Current vs. Temperature

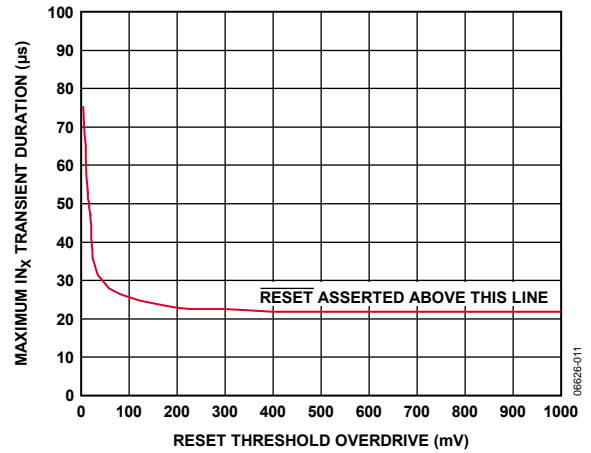

Figure 7. Maximum  $I_{N_x}$  Transient Duration vs. Reset Threshold Overdrive

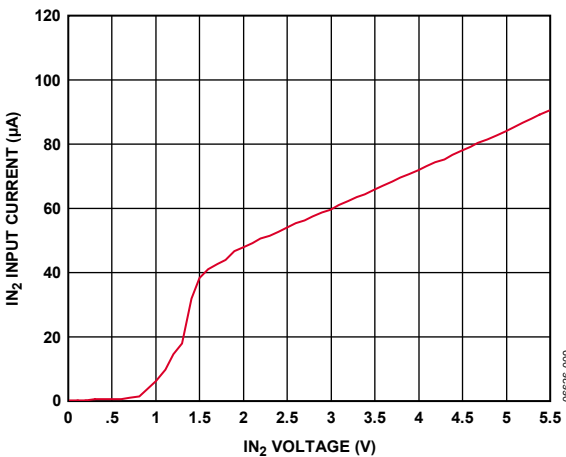

Figure 5.  $I_{N2}$  Input Current vs.  $I_{N2}$  Voltage

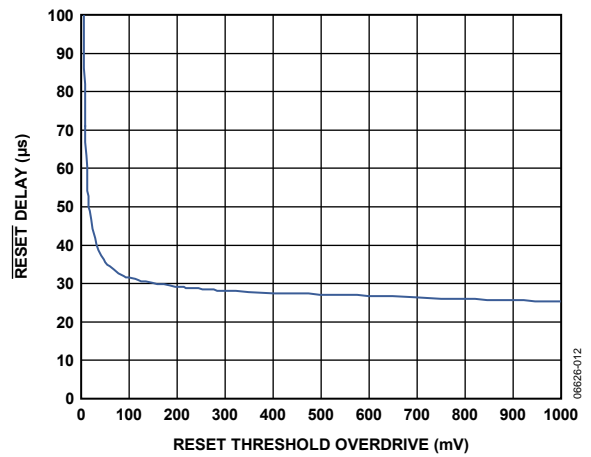

Figure 8.  $\overline{RESET}$  Delay vs. Reset Threshold Overdrive ( $I_{N_x}$  Decreasing)

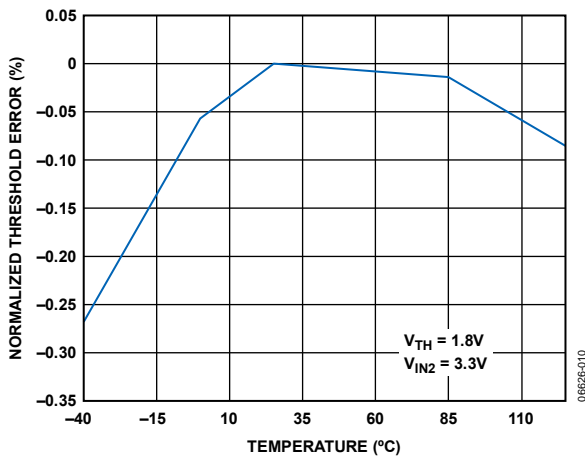

Figure 6. Normalized Threshold Error vs. Temperature

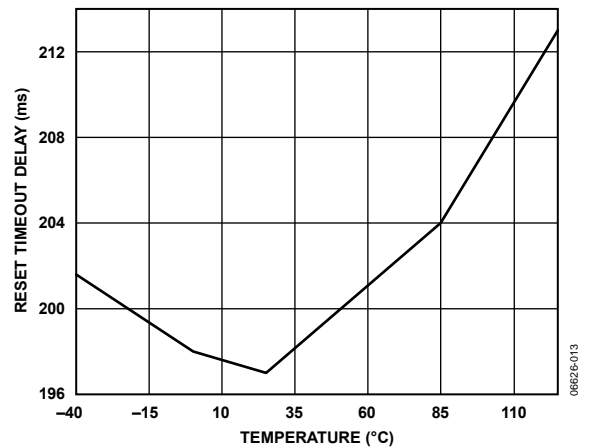

Figure 9. Reset Timeout Delay vs. Temperature

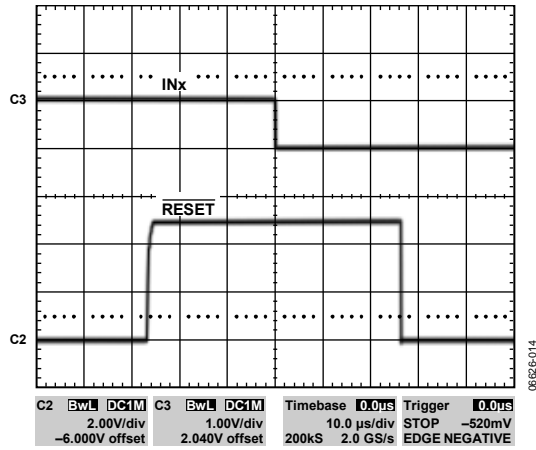

Figure 10. RESET Pull-Up and Pull-Down Response (10 μs/div)

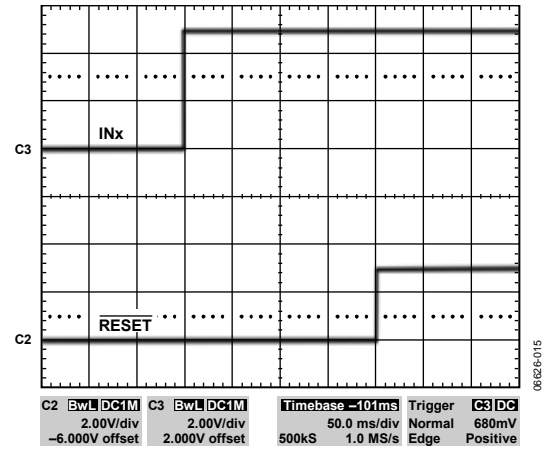

Figure 11. RESET Timeout Delay (50 ms/div)

## THEORY OF OPERATION

The ADM6710 is a compact, low power supervisory circuit capable of monitoring up to four voltages in a multisupply application.

The device includes several factory-set voltage threshold options for monitoring 1.8 V, 2.5 V, 3.0 V, 3.3 V and 5.0 V supplies. It also provides up to three adjustable thresholds for monitoring voltages down to 0.62 V. See the Ordering Guide section for a list and description of all available options.

The ADM6710Q has three adjustable voltage inputs and is powered by V<sub>CC</sub>, which is not a monitored voltage. All other ADM6710 devices are powered by IN<sub>2</sub>, which is a monitored voltage, and therefore monitors up to four voltages. If a monitored voltage drops below its associated threshold, the active low reset output asserts low and remains low while either IN<sub>1</sub> or IN<sub>2</sub> remains above 1.0 V.

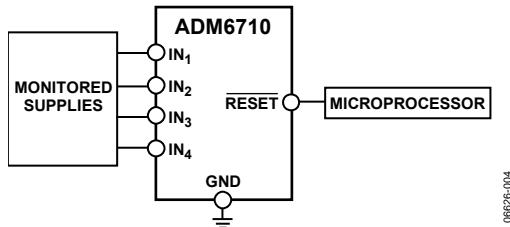

Figure 12. Typical Applications Circuit

## INPUT CONFIGURATION

The ADM6710 provides numerous monitor choices with adjustable reset thresholds. Typically, the threshold voltage at each adjustable IN<sub>x</sub> input is 0.62 V. To monitor a voltage greater than 0.62 V, connect a resistor divider network to the circuit as depicted in Figure 13, where

$$V_{INTH} = 0.62 V \left( \frac{R_1 + R_2}{R_2} \right)$$

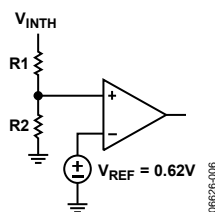

Figure 13. Setting the Adjustable Monitor

The internal comparators each typically have a hysteresis of 0.3% with respect to the reset threshold. This built-in hysteresis improves the device's immunity to ambient noise without noticeably reducing the threshold accuracy. The ADM6710 is unaffected by short input transients.

The ADM6710 is powered from the monitored IN<sub>2</sub>, or V<sub>CC</sub> in the case of the ADM6710Q. Monitored inputs are resistant to short power supply glitches. Figure 7 depicts the ADM6710 glitch immunity data. To increase noise immunity in noisy applications, place a 0.1 μF capacitor between the IN<sub>2</sub> input and ground.

Adding capacitance to IN<sub>1</sub>, IN<sub>3</sub>, and IN<sub>4</sub> also improves noise immunity.

Do not allow unused monitor inputs to float or to be grounded. Connect these inputs to a supply voltage greater than their specified threshold voltages. In the case of unused IN<sub>x</sub> adjustable inputs, limit the bias current by connecting a 1 MΩ series resistor between the unused input and IN<sub>2</sub> (or V<sub>CC</sub> in the case of the ADM6710Q).

## RESET OUTPUT CONFIGURATION

The  $\overline{\text{RESET}}$  output asserts low if a monitored IN<sub>x</sub> voltage drops below its voltage threshold. Once all voltages rise above the selected threshold level, the reset signal remains low for the reset timeout period (200 ms typical). The reset output is open drain with a weak internal pull-up to the monitored IN<sub>2</sub> or V<sub>CC</sub> supply, typically 10 μA.

Many applications that interface with other logic devices do not require an external pull-up resistor. However, if an external pull-up resistor is required and it is connected to a voltage ranging from 0 V to 5.5 V, it will overdrive the internal pull-up. Reverse current flow from the external pull-up voltage to IN<sub>2</sub> is prevented by the internal circuitry.

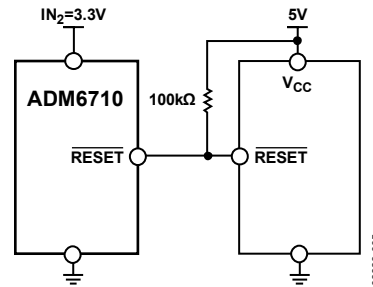

Figure 14. Interface with a Different Logic Supply Voltage

## ADDITION OF MANUAL RESET

Use the circuit shown in Figure 15 to add manual reset to any of the ADM6710 adjustable inputs. When the switch is closed, the analog input shorts to ground and a  $\overline{\text{RESET}}$  output commences. The switch must remain open for a minimum of 140 ms for the  $\overline{\text{RESET}}$  output to deassert.

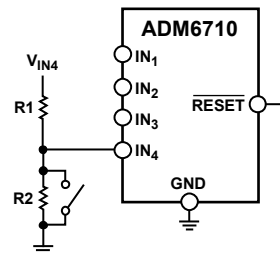
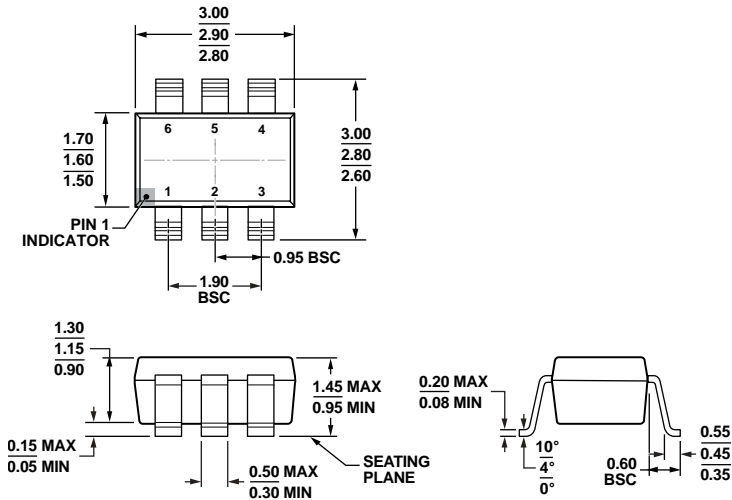

Figure 15. Addition of Manual Reset (IN<sub>4</sub> is an Adjustable Input)

### OUTLINE DIMENSIONS



COMPLIANT TO JEDEC STANDARDS MO-178-AB

Figure 16. 6-Lead Small Outline Transistor Package [SOT-23] (RJ-6)

Dimensions shown in millimeters

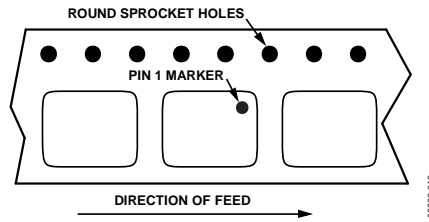

Figure 17. ADM6710 Reel Orientation

### ORDERING GUIDE

Model <sup>1, 2</sup>	Nominal Input Voltage				Supply Tolerance (%)	Temperature Range	Package Description	Package Option	Branding
	IN <sub>1</sub>	IN <sub>2</sub>	IN <sub>3</sub>	IN <sub>4</sub>					
ADM6710AARJZ-REEL7	5	3.3	2.5	Adj.	10	-40°C to +125°C	6-Lead SOT-23	RJ-6	MA9
ADM6710BARJZ-REEL7	5	3.3	2.5	Adj.	5	-40°C to +125°C	6-Lead SOT-23	RJ-6	MAH
ADM6710CARJZ-REEL7	5	3.3	1.8	Adj.	10	-40°C to +125°C	6-Lead SOT-23	RJ-6	MAJ
ADM6710DARJZ-REEL7	5	3.3	1.8	Adj.	5	-40°C to +125°C	6-Lead SOT-23	RJ-6	MAK
ADM6710EARJZ-REEL7	Adj.	3.3	2.5	1.8	10	-40°C to +125°C	6-Lead SOT-23	RJ-6	MAX
ADM6710FARJZ-REEL7	Adj.	3.3	2.5	1.8	5	-40°C to +125°C	6-Lead SOT-23	RJ-6	MA4
ADM6710GARJZ-REEL7	5	3.3	Adj.	Adj.	10	-40°C to +125°C	6-Lead SOT-23	RJ-6	MAL
ADM6710HARJZ-REEL7	5	3.3	Adj.	Adj.	5	-40°C to +125°C	6-Lead SOT-23	RJ-6	MAM
ADM6710IARJZ-REEL7	Adj.	3.3	2.5	Adj.	10	-40°C to +125°C	6-Lead SOT-23	RJ-6	MAN
ADM6710JARJZ-REEL7	Adj.	3.3	2.5	Adj.	5	-40°C to +125°C	6-Lead SOT-23	RJ-6	MAP
ADM6710KARJZ-REEL7	Adj.	3.3	1.8	Adj.	10	-40°C to +125°C	6-Lead SOT-23	RJ-6	MAQ
ADM6710LARJZ-REEL7	Adj.	3.3	1.8	Adj.	5	-40°C to +125°C	6-Lead SOT-23	RJ-6	MAR
ADM6710MARJZ-REEL7	Adj.	3	2.5	Adj.	10	-40°C to +125°C	6-Lead SOT-23	RJ-6	MAS
ADM6710NARJZ-REEL7	Adj.	3	2.5	Adj.	5	-40°C to +125°C	6-Lead SOT-23	RJ-6	MAT
ADM6710OARJZ-REEL7	Adj.	3	1.8	Adj.	10	-40°C to +125°C	6-Lead SOT-23	RJ-6	MAU
ADM6710PARJZ-REEL7	Adj.	3	1.8	Adj.	5	-40°C to +125°C	6-Lead SOT-23	RJ-6	MAV
ADM6710QARJZ-REEL7	Adj.	V <sub>CC</sub>	Adj.	Adj.	Not applicable	-40°C to +125°C	6-Lead SOT-23	RJ-6	MAW

<sup>1</sup> Z = RoHS Compliant Part.

<sup>2</sup> Adjustable voltage based on 0.62 V internal threshold. The external threshold voltage can be set using an external resistor divider.

**NOTES**

**NOTES**

**NOTES**

## Looking for pricing, stock, or lifecycle information?

Click below to explore more details on WIN SOURCE:

- ⊖ [View ADM6710QARJZ-REEL7 on WIN SOURCE](#)
- ⊖ [Analog Devices Inc. Information](#)

## Optimize Your Supply Chain with WIN SOURCE Solutions

- ✓ Global Sourcing Solution
- ✓ Obsolete Management
- ✓ Cost Control Management
- ✓ Shortage Management
- ✓ Alternative Solution
- ✓ Excess Inventory Management