



**THE DATASHEET OF
SBL1040CT**



Features

- Schottky Barrier Chip
- Guard Ring Die Construction for Transient Protection
- Low Power Loss, High Efficiency
- High Surge Capability
- High Current Capability and Low Forward Voltage Drop
- For Use in Low Voltage, High Frequency Inverters, Free Wheeling, and Polarity Protection Applications
- **Lead Free Finish, RoHS Compliant (Note 3)**

Mechanical Data

- Case: TO-220AB
- Case Material: Molded Plastic. UL Flammability Classification Rating 94V-0
- Moisture Sensitivity: Level 1 per J-STD-020C
- Polarity: As Marked on Body
- Terminals: Finish – Bright Tin. Solderable per MIL-STD-202, Method 208
- Marking: Type Number
- Weight: 2.24 grams (approximate)

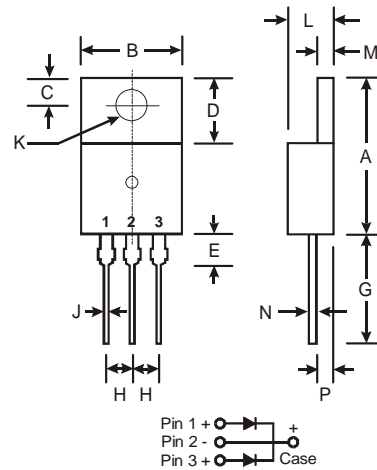

TO-220AB		
Dim	Min	Max
A	14.48	15.75
B	10.00	10.40
C	2.54	3.43
D	5.90	6.40
E	2.80	3.93
G	12.70	14.27
H	2.40	2.70
J	0.69	0.93
K	3.54	3.78
L	4.07	4.82
M	1.15	1.39
N	0.30	0.50
P	2.04	2.79
All Dimensions in mm		

Maximum Ratings and Electrical Characteristics @T_A = 25°C unless otherwise specified

Characteristic	Symbol	SBL 1030CT	SBL 1035CT	SBL 1040CT	SBL 1045CT	SBL 1050CT	SBL 1060CT	Unit
Peak Repetitive Reverse Voltage	V _{RRM}							
Working Peak Reverse Voltage	V _{RWM}	30	35	40	45	50	60	V
DC Blocking Voltage	V _R							
RMS Reverse Voltage	V _{R(RMS)}	21	24.5	28	31.5	35	42	V
Average Rectified Output Current @ T _C = 95°C (Note 1)	I _O	10						A
Non-Repetitive Peak Forward Surge Current 8.3ms single half sine-wave superimposed on rated load	I _{FSM}	175						A
Forward Voltage Drop @ I _F = 5.0A, T _C = 25°C	V _{FM}	0.55				0.70		V
Peak Reverse Current @ T _C = 25°C at Rated DC Blocking Voltage @ T _C = 125°C	I _{RM}	0.5				50		mA
Typical Junction Capacitance (Note 2)	C _j	450						pF
Typical Thermal Resistance Junction to Case (Note 1)	R _{θJC}	5.5						°C/W
Operating and Storage Temperature Range	T _j , T _{STG}	-65 to +150						°C

- Notes:
1. Thermal resistance junction to case mounted on heatsink.
 2. Measured at 1.0MHz and applied reverse voltage of 4.0V DC.
 3. RoHS revision 13.2.2003. Glass and high temperature solder exemptions applied, see *EU Directive Annex Notes 5 and 7*.

DISCONTINUED

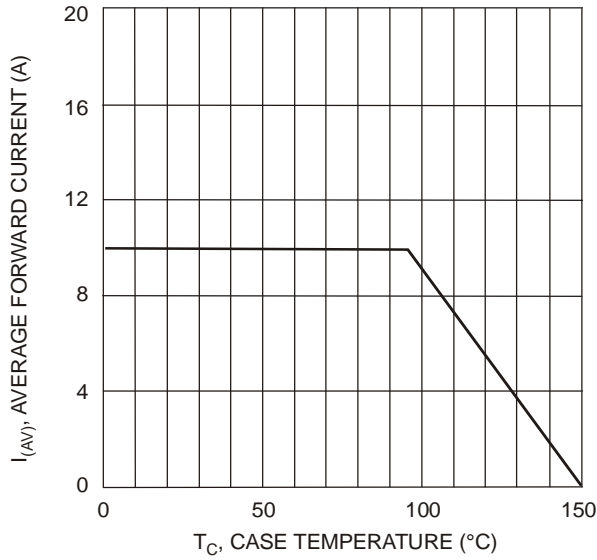

Fig. 1 Forward Current Derating Curve

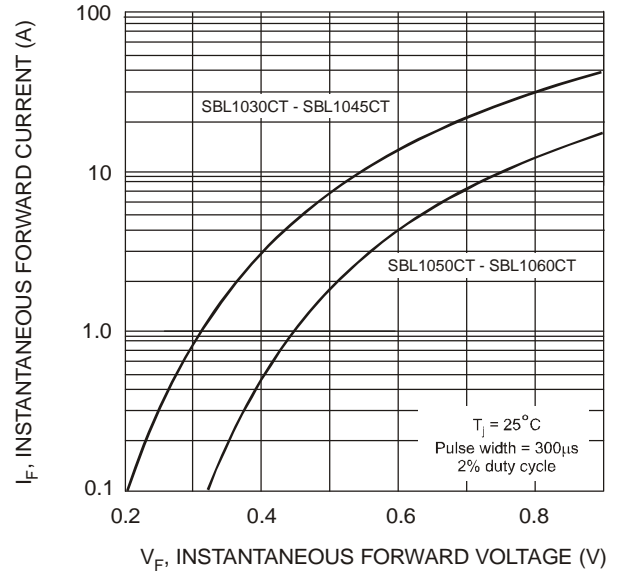

Fig. 2 Typical Forward Characteristics per Element

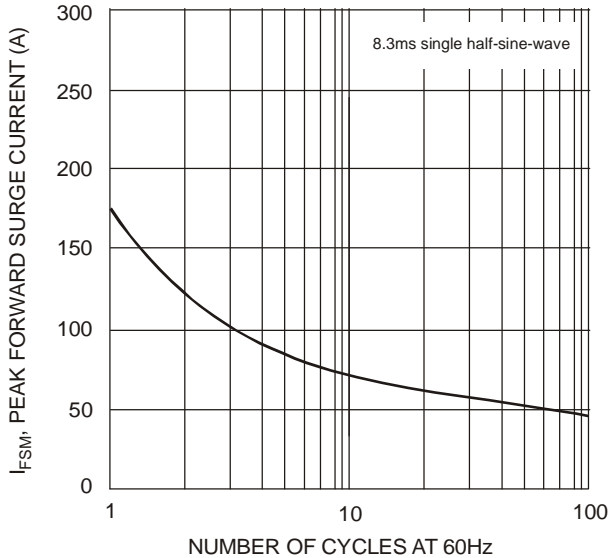

Fig. 3 Max Non-Repetitive Surge Current

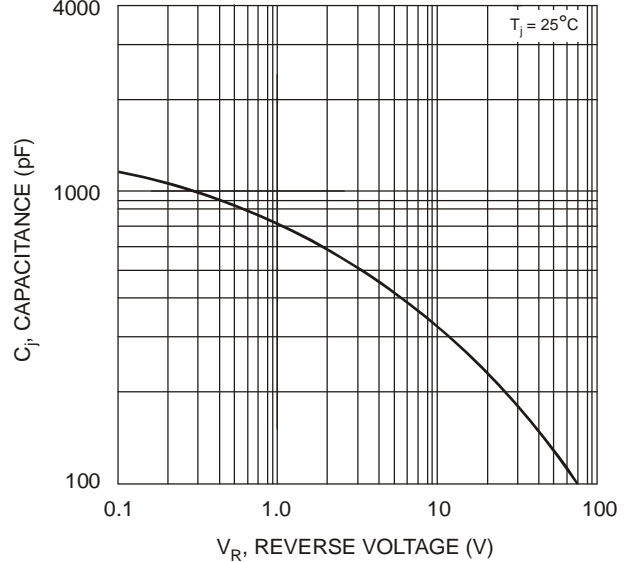

Fig. 4 Typical Junction Capacitance per Element

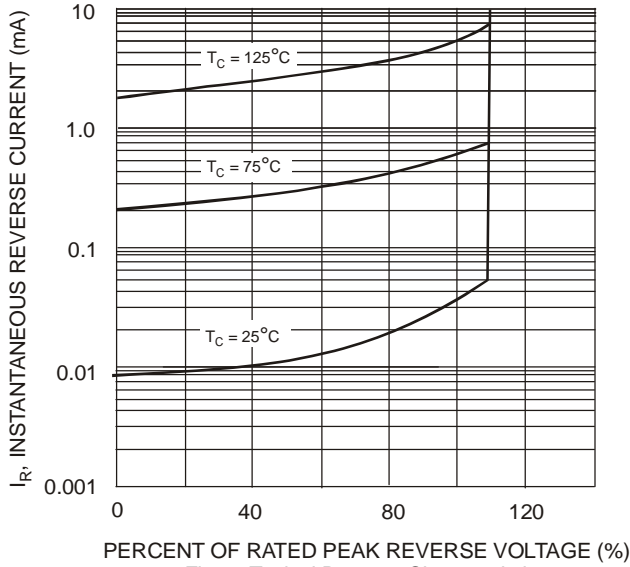

Fig. 5 Typical Reverse Characteristics

DISCONTINUED

Ordering Information (Note 4)

Device	Packaging	Shipping
SBL10xxCT*	TO-220AB	50/Tube

* xx = Device type, e.g. SBL1045CT

Notes: 4. For packaging details, visit our website at <http://www.diodes.com/datasheets/ap02008.pdf>.

IMPORTANT NOTICE



Diodes Incorporated and its subsidiaries reserve the right to make modifications, enhancements, improvements, corrections or other changes without further notice to any product herein. Diodes Incorporated does not assume any liability arising out of the application or use of any product described herein; neither does it convey any license under its patent rights, nor the rights of others. The user of products in such applications shall assume all risks of such use and will agree to hold Diodes Incorporated and all the companies whose products are represented on our website, harmless against all damages.

LIFE SUPPORT

Diodes Incorporated products are not authorized for use as critical components in life support devices or systems without the expressed written approval of the President of Diodes Incorporated.

Looking for pricing, stock, or lifecycle information?

Click below to explore more details on WIN SOURCE:

-  [View SBL1040CT on WIN SOURCE](#)
-  [Diodes Incorporated Information](#)

Optimize Your Supply Chain with WIN SOURCE Solutions

-  Global Sourcing Solution
-  Obsolete Management
-  Cost Control Management
-  Shortage Management
-  Alternative Solution
-  Excess Inventory Management