



THE DATASHEET OF ADNS-5050



ADNS-5050

Optical Mouse Sensor



Data Sheet



Description

The ADNS-5050 is a mainstream, small form factor optical mouse sensor. It is a user-friendly product with many built-in features and optimized for LED-based corded products.

The ADNS-5050 is capable of high-speed motion detection – up to 30ips and 8g. In addition, it has an on-chip oscillator and built-in LED driver to minimize external components. Frame rate is also adjusted internally.

The ADNS-5050 along with the 5100-001 lens, LED clip and HLMP-EG3E-xxxxx LED form a complete and compact mouse tracking system. There are no moving parts, which mean high reliability and less maintenance for the end user. In addition, precision optical alignment is not required, facilitating high volume assembly.

The sensor is programmed via registers through a three-wire SPI interface. It is housed in an 8-pin staggered dual in-line package (DIP).

Theory of Operation

The ADNS-5050 is based on Optical Navigation Technology, which measures changes in position by optically acquiring sequential surface images (frames) and mathematically determining the direction and magnitude of movement.

The ADNS-5050 contains an Image Acquisition System (IAS), a Digital Signal Processor (DSP), and a three wire serial port.

The IAS acquires microscopic surface images via the lens and illumination system. These images are processed by the DSP to determine the direction and distance of motion. The DSP calculates the Δx and Δy relative displacement values.

An external microcontroller reads the Δx and Δy information from the sensor serial port. The microcontroller then translates the data into PS2 or USB signals before sending them to the host PC.

Features

- Small form factor, pin-to-pin compatible with ADNS-5020-EN
- Register-to-register compatible with ADNS-5020-EN
- Built-in LED driver for simpler circuitry
- High speed motion detection at 30 ips and up to 8g
- Self-adjusting frame rate for optimum performance
- Internal oscillator – no clock input needed
- Default 500 cpi resolution, adjustable from 125 to 1375 cpi via 125 cpi step
- Operating voltage: 5V nominal
- Three-wire serial interface
- Only 4 capacitors and no transistor required

Applications

- Optical Mice
- Optical trackballs
- Integrated input devices

Pinout of ADNS-5050 Optical Mouse Sensor

Pin	Name	Description	I/O type
1	SDIO	Serial Port Data Input and Output	I/O
2	XY_LED	LED Control	O
3	NRESET	Reset Pin (active low input)	I
4	NCS	Chip Select (active low input)	I
5	V _{DD5}	Supply Voltage	Power
6	GND	Ground	Ground
7	REGO	Regulator Output	O
8	SCLK	Serial Clock Input	I

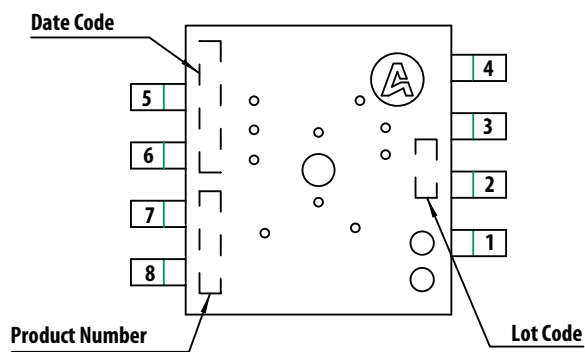

Item	Marking	Remarks
Product Number	A5050	
Date Code	XYWWZ	X = Subcon Code YYWW = Date Code Z = Sensor Die Source
Lot Code	VVV	Numeric

Figure 1. Package outline drawing (top view).

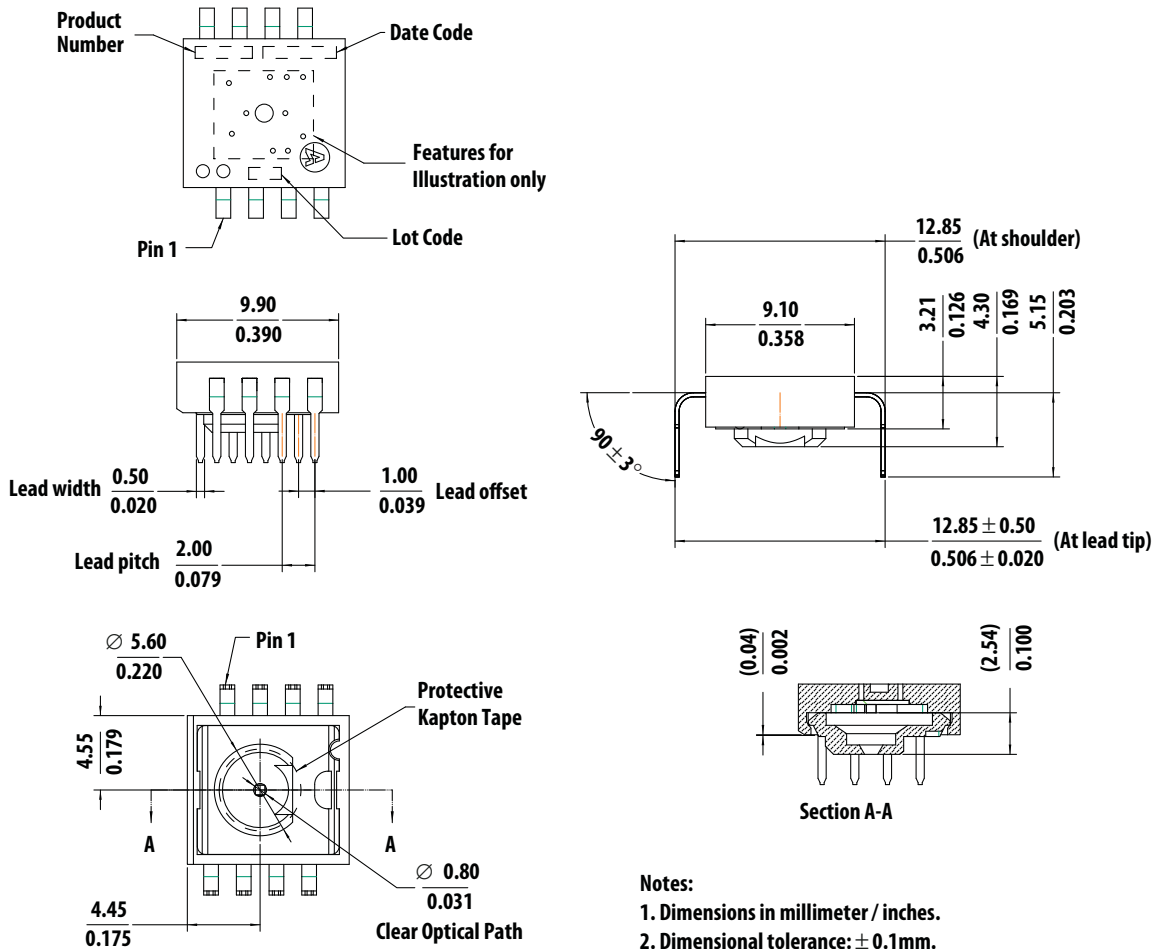

- Notes:**
1. Dimensions in millimeter / inches.
 2. Dimensional tolerance: ± 0.1 mm.
 3. Coplanarity of leads: 0.1mm.
 4. Lead pitch tolerance: ± 0.15 mm.
 5. Non-cumulative pitch tolerance: ± 0.15 mm.
 6. Angular tolerance: $\pm 3^\circ$
 7. Maximum flash: 0.2mm.
 8. Brackets () indicate reference dimension.
 9. Document Number: LED_DIFF_8B_PKG_002

Figure 2. Package outline drawing

CAUTION: It is advised that normal static precautions be taken in handling and assembly of this component to prevent damage and/or degradation which may be induced by ESD.

Overview of Optical Mouse Sensor Assembly

Avago Technologies provides an IGES file drawing describing the base plate molding features for lens and PCB alignment.

The ADNS-5050 sensor is designed for mounting on a through-hole PCB, looking down. There is an aperture stop and features on the package that align to the lens.

The ADNS-5100-001 lens provides optics for the imaging of the surface as well as illumination of the surface at the optimum angle. Features on the lens align it to the sensor, base plate, and clip with the LED.

The LED clip holds the LED in relation to the lens. The LED must be inserted into the clip and the LED's leads formed prior to loading on the PCB.

The HLMP-EG3E-xxxxx LED is recommended for illumination.

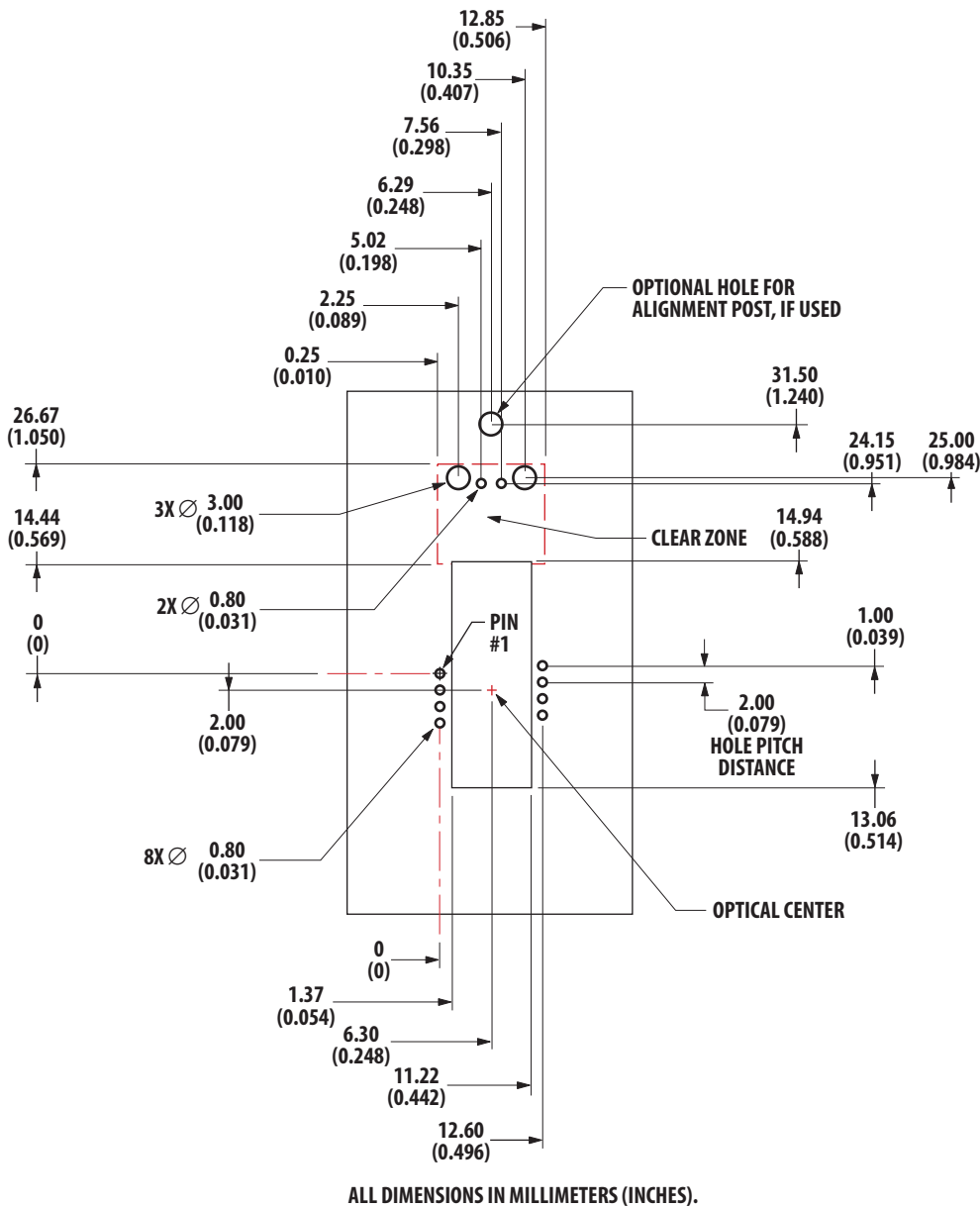
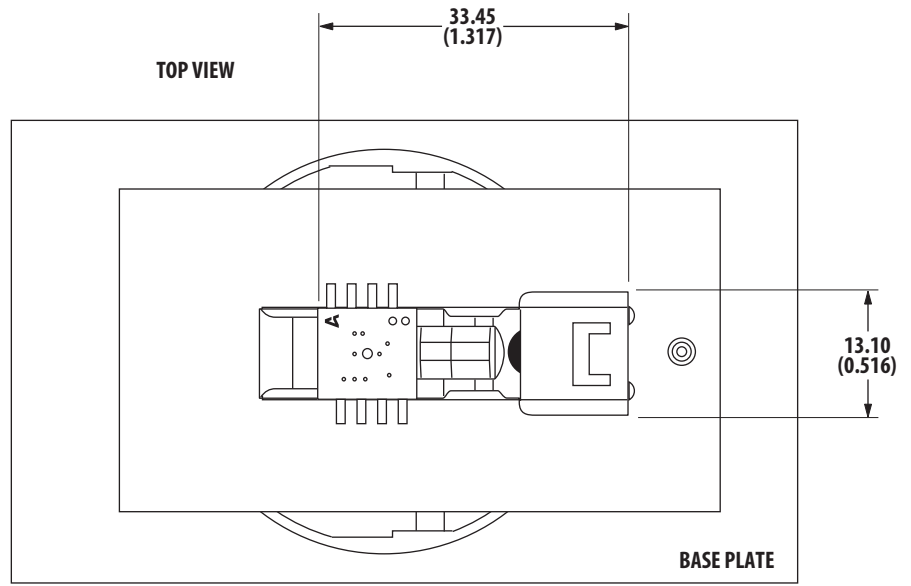

Figure 3. Recommended PCB mechanical cutouts and spacing.



DIMENSIONS IN mm (INCHES)

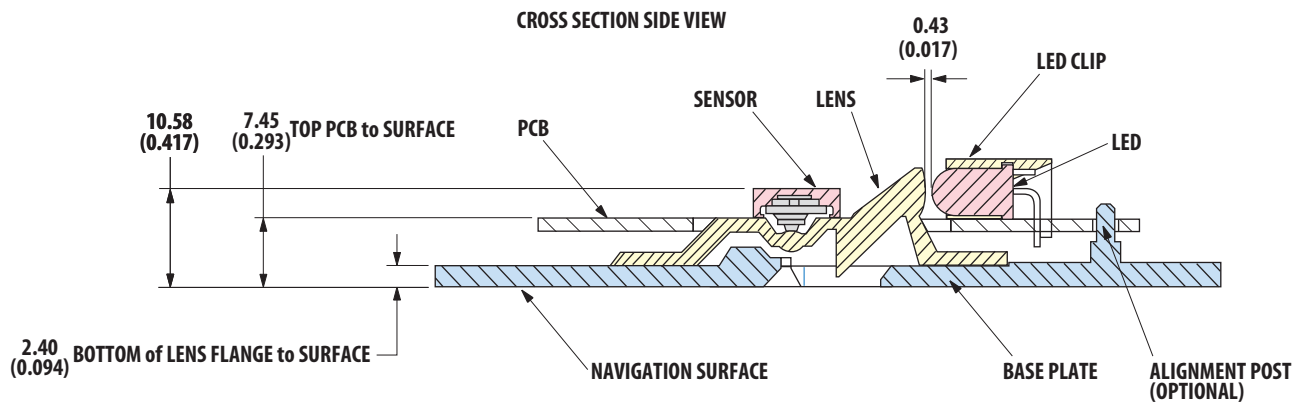

Figure 4. 2D Assembly drawing of ADNS-5050 (top and side views).

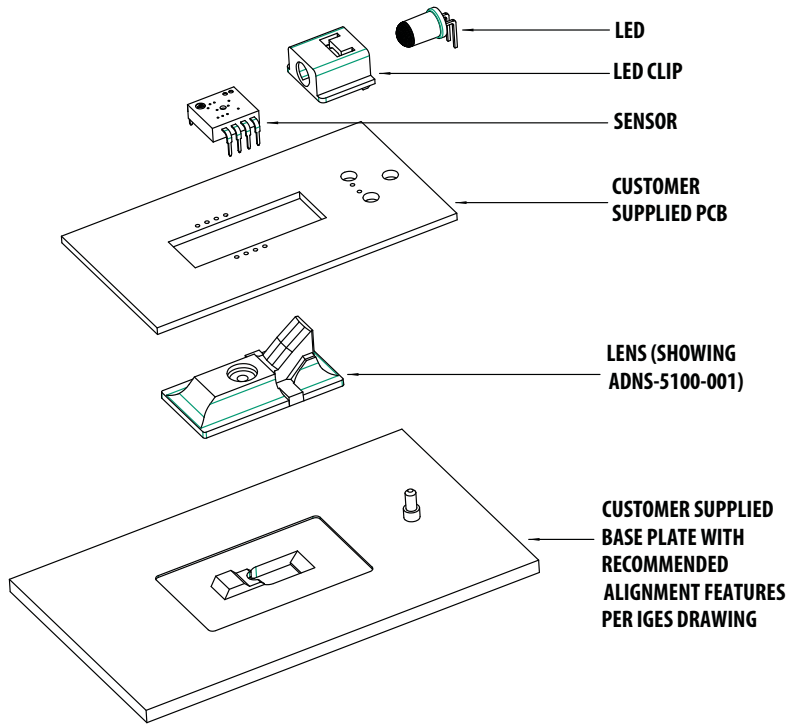

Figure 5. Exploded view drawing.

PCB Assembly Considerations

1. Insert the sensor and all other electrical components into PCB.
2. Insert the LED into the assembly clip and bend the leads 90 degrees.
3. Insert the LED clip assembly into PCB.
4. This sensor package is only qualified for wave-solder process.
5. Wave solder the entire assembly in a no-wash solder process utilizing solder fixture. The solder fixture is needed to protect the sensor during the solder process. It also sets the correct sensor-to-PCB distance as the lead shoulders do not normally rest on the PCB surface. The fixture should be designed to expose the sensor leads to solder while shielding the optical aperture from direct solder contact.
6. Place the lens onto the base plate.
7. Remove the protective kapton tape from optical aperture of the sensor. Care must be taken to keep contaminants from entering the aperture. Recommend not to place the PCB facing up during the entire mouse assembly process. Recommend to hold the PCB first vertically for the kapton removal process.
8. Insert PCB assembly over the lens onto the base plate aligning post to retain PCB assembly. The sensor aperture ring should self-align to the lens.
9. The optical position reference for the PCB is set by the base plate and lens. Note that the PCB motion due to button presses must be minimized to maintain optical alignment.
10. Install mouse top case. There MUST be a feature in the top case to press down onto the PCB assembly to ensure all components are interlocked to the correct vertical height.

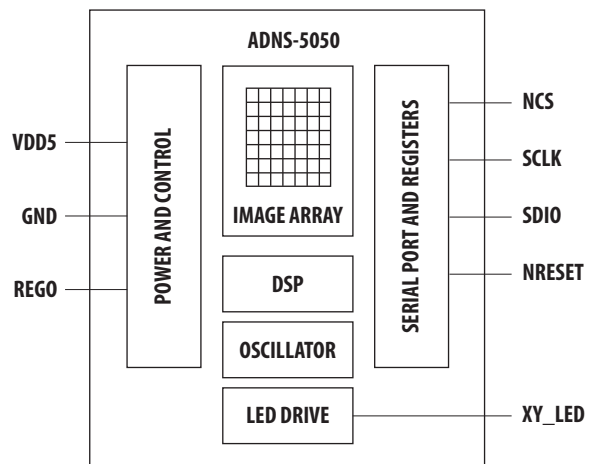

Figure 6. Block diagram of ADNS-5050 optical mouse sensor.

Design Considerations for Improved ESD Performance

For improved electrostatic discharge performance, typical creepage and clearance distance are shown in the table below. Assumption: base plate construction as per the Avago Technologies supplied IGES file and ADNS-5100-001 lens.

Typical Distance	A5100-001
Creepage	17.9
Clearance	9.2

NOTE: The lens material is polycarbonate or polystyrene HH30, therefore, cyanoacrylate based adhesives or other adhesives that may damage the lens should **NOT** be used.

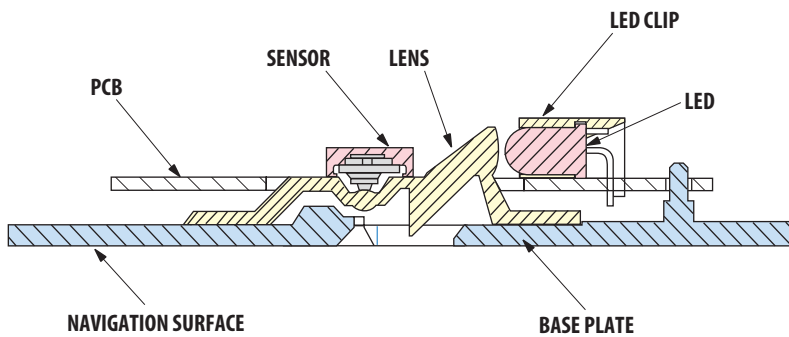

Figure 7. Sectional view of PCB assembly highlighting optical mouse components.

Regulatory Requirements

- Passes FCC B and worldwide analogous emission limits when assembled into a mouse with shielded cable and following Avago Technologies recommendations.
- Passes IEC-1000-4-3 radiated susceptibility level when assembled into a mouse with shielded cable and following Avago Technologies recommendations.
- Passes EN61000-4-4/IEC801-4 EFT tests when assembled into a mouse with shielded cable and following Avago Technologies recommendations.
- UL flammability level UL94 HB.
- Provides sufficient ESD creepage/clearance distance to avoid discharge up to 15 kV when assembled into a mouse using lens according to usage instructions above.

Absolute Maximum Ratings

Parameter	Symbol	Minimum	Maximum	Units	Notes
Storage Temperature	T_S	-40	85	°C	
Lead Solder Temp			260	°C	
Supply Voltage	V_{DD}	-0.5	5.5	V	
ESD			2	kV	All pins, human body model MIL 883 Method 3015
Input Voltage	V_{IN}	-0.5	$V_{DD}+0.5$	V	All I/O pins
Output Current	I_{out}		7	mA	SDIO pin

Recommended Operating Conditions

Parameter	Symbol	Minimum	Typical	Maximum	Units	Notes
Operating Temperature	T_A	0		40	°C	
Power Supply	V_{DD}	4.0	5.0	5.25	V	
Power Supply Rise Time	V_{RT}	0.005		100	ms	0 to V_{DD}
Supply Noise (Sinusoidal)	V_{NA}			100	mV p-p	10 kHz-50 MHz
Serial Port Clock Frequency	f_{SCLK}			3	MHz	50% duty cycle.
Distance from Lens Reference Plane to Tracking Surface (Z)	Z	2.3	2.4	2.5	mm	
Speed	S		30		ips	
Acceleration	a			8	g	
Load Capacitance	C_{out}			100	pF	SDIO

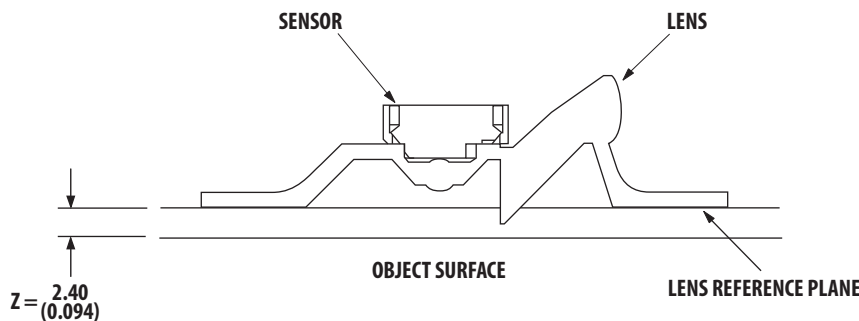

Figure 9. Distance from lens reference plane to tracking surface (Z).

AC Electrical Specifications

Electrical Characteristics over recommended operating conditions. Typical values at 25 °C, $V_{DD} = 5.0$ V.

Parameter	Symbol	Minimum	Typical	Maximum	Units	Notes
Power Down	t_{PD}			50	ms	From PD (when bit 1 of register 0x0d is set) to low current
Wake from Power Down	t_{WAKEUP}	50		55	ms	From PD inactive (when NRESET pin is asserted high or write 0x5a to register 0x3a) to valid motion
Reset Pulse Width	t_{RESET}	250			ns	Active low.
Motion Delay after Reset	$t_{MOT-RST}$			50	ms	From NRESET pull high to valid motion, assuming V_{DD} and motion is present.
SDIO Rise Time	t_{r-SDIO}		150	300	ns	$C_L = 100$ pF
SDIO Fall Time	t_{f-SDIO}		150	300	ns	$C_L = 100$ pF
SDIO delay after SCLK	$t_{DLY-SDIO}$			120	ns	From SCLK falling edge to SDIO data valid, no load conditions.
SDIO Hold Time	$t_{hold-SDIO}$	100			ns	Data held until next falling SCLK edge.
SDIO Setup Time	$t_{setup-SDIO}$	120			ns	From data valid to SCLK rising edge.
SPI Time between Write Commands	t_{SWW}	30			μ s	From rising SCLK for last bit of the first data byte, to rising SCLK for last bit of the second data byte.
SPI Time between Write and Read Commands	t_{SWR}	20			μ s	From rising SCLK for last bit of the first data byte, to rising SCLK for last bit of the second address byte.
SPI Time between Read and Subsequent Commands	t_{SRW} t_{SRR}	500			ns	From rising SCLK for last bit of the first data byte, to falling SCLK for the first bit of the next address.
SPI Read Address-Data Delay	t_{SRAD}	4		10	μ s	From rising SCLK for last bit of the address byte, to falling SCLK for first bit of data being read.
NCS Inactive after Motion Burst	t_{BEXIT}	250			ns	Minimum NCS inactive time after motion burst before next SPI usage.
NCS to SCLK Active	$t_{NCS-SCLK}$	120			ns	From NCS falling edge to first SCLK rising edge.
SCLK to NCS Inactive (for read operation)	$t_{SCLK-NCS}$	120			ns	From last SCLK rising edge to NCS rising edge, for valid SDIO data transfer.
SCLK to NCS Inactive (for write operation)	$t_{SCLK-NCS}$	20			us	From last SCLK rising edge to NCS rising edge, for valid SDIO data transfer.
NCS to SDIO High-Z	$t_{NCS-SDIO}$			500	ns	From NCS rising edge to SDIO high-Z state.
Transient Supply Current	I_{DDT}			60	mA	Max supply current during a V_{DD} ramp from 0 to V_{DD} .

DC Electrical Specifications

Electrical Characteristics over recommended operating conditions. Typical values at 25 °C, $V_{DD} = 5.0$ V.

Parameter	Symbol	Minimum	Typical	Maximum	Units	Notes
DC Supply Current	I_{DD_AVG}		13.0	16.0	mA	Average sensor current, at max frame rate. No load on SDIO.
Idle Supply Current	I_{DD_IDLE}		11.0		mA	
Power Down Supply Current	I_{DD_PD}		180	250	μ A	SCLK, NCS, NRESET, SDIO=VDD
Input Low Voltage	V_{IL}			0.5	V	SCLK, SDIO, NCS, NRESET
Input High Voltage	V_{IH}	$V_{DD} - 0.5$			V	SCLK, SDIO, NCS, NRESET
Input Hysteresis	V_{I_HYS}		200		mV	SCLK, SDIO, NCS, NRESET
Input Leakage Current	I_{leak}		± 1	± 10	μ A	$V_{in} = V_{DD} - 0.6$ V, SCLK, SDIO, NCS, NRESET
XY_LED Current (pin voltage range should be greater than 0.8 V.)	I_{XY_LED}		45		mA	Average current at maximum frame rate.
XY_LED Current (pin voltage range should be greater than 0.8 V.)	I_{XY_PK}		45	51.5	mA	Peak current at maximum frame rate. Follow recommended schematics in Figure 8 to ensure DC current flowing through LED during run mode is within LED's absolute maximum limit.
Output Low Voltage	V_{OL}			0.7	V	$I_{out} = 1$ mA, SDIO
Output High Voltage	V_{OH}	$V_{DD} - 0.7$			V	$I_{out} = -1$ mA, SDIO
Input Capacitance	C_{in}		50		pF	
Frame Rate	F_R		4500		fps	Internally adjusted by sensor (value shown is based on internal oscillator frequency of 28MHZ)

Typical Performance Characteristics

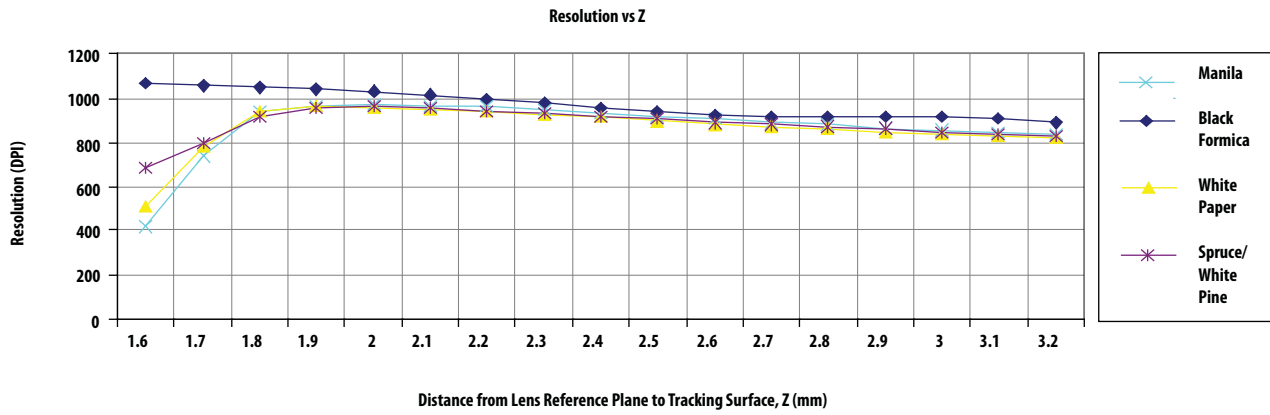

Figure 10. Mean resolution vs. distance from lens reference plane to surface.

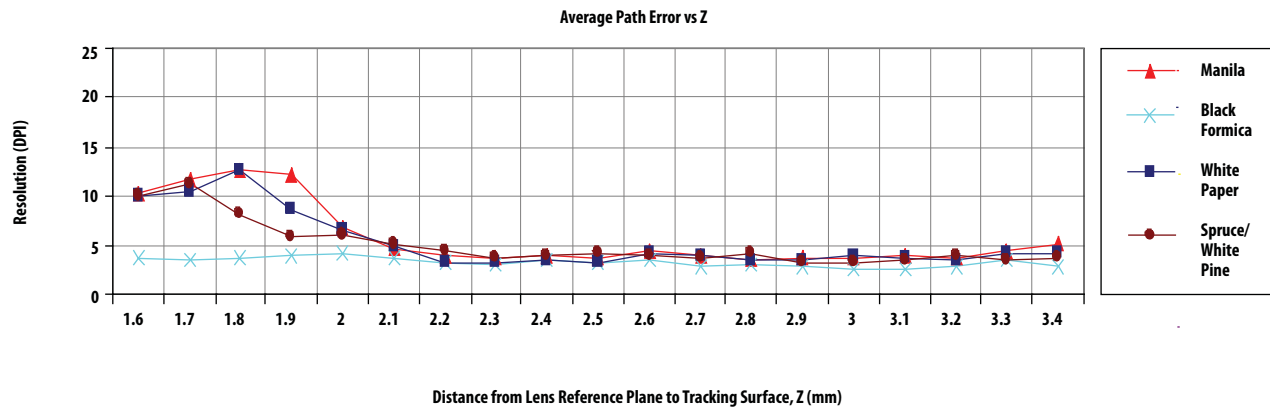

Figure 11. Average error vs. distance (mm).

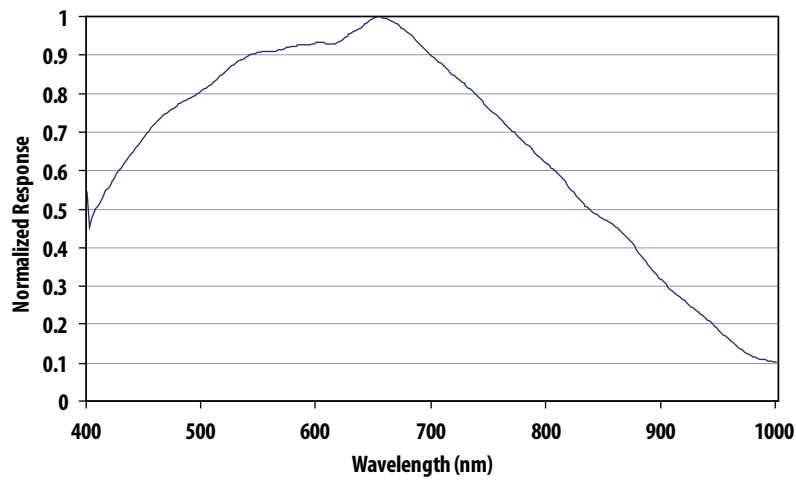

Figure 12. Relative wavelength responsivity.

LED Mode

For optimized tracking performance, the LED is in DC mode when motion is detected, and ADNS-5050 will pulse the LED when the mouse is in idle state. To force the LED into always DC mode, kindly refer to register 0x22.

Synchronous Serial Port

The synchronous serial port is used to set and read parameters in the ADNS-5050, and to read out the motion information.

The port is a three wire serial port. The host micro-controller always initiates communication; the ADNS-5050 never initiates data transfers. SCLK, SDIO, and NCS may be driven directly by a micro-controller. The port pins may be shared with other SPI slave devices. When the NCS pin is high, the inputs are ignored and the output is tri-stated.

The lines that comprise the SPI port:

- SCLK: Clock input. It is always generated by the master (the micro-controller).
- SDIO: Input and Output data.
- NCS: Chip select input (active low). NCS needs to be low to activate the serial port; otherwise, SDIO will be high Z, and SDIO & SCLK will be ignored. NCS can also be used to reset the serial port in case of an error.

Chip Select Operation

The serial port is activated after NCS goes low. If NCS is raised during a transaction, the entire transaction is aborted and the serial port will be reset. This is true for all transactions. After a transaction is aborted, the normal address-to-data or transaction-to-transaction delay is still required before beginning the next transaction. To improve communication reliability, all serial transactions should be framed by NCS. In other words, the port should not remain enabled during periods of non-use because ESD and EFT/B events could be interpreted as serial communication and put the chip into an unknown state. In addition, NCS must be raised after each burst-mode transaction is complete to terminate burst-mode. The port is not available for further use until burst-mode is terminated.

Write Operation

Write operation, defined as data going from the micro-controller to the ADNS-5050, is always initiated by the micro-controller and consists of two bytes. The first byte contains the address (seven bits) and has a "1" as its MSB to indicate data direction. The second byte contains the data. The ADNS-5050 reads SDIO on rising edges of SCLK.

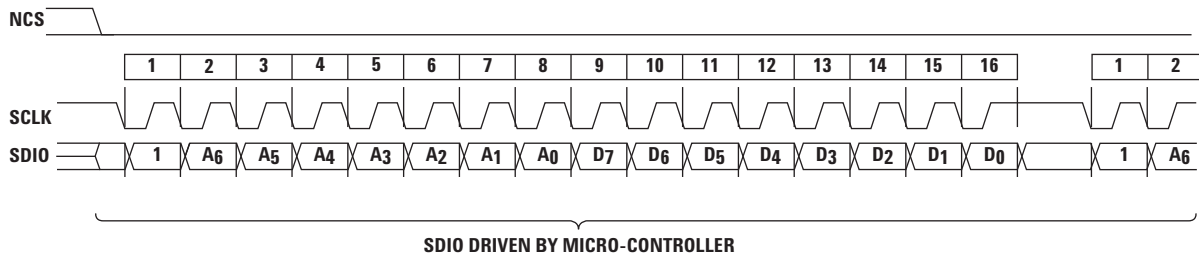

Write Operation

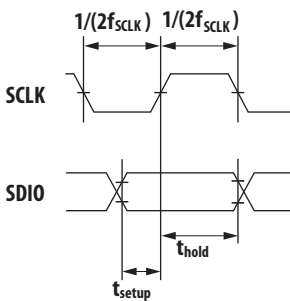

SDIO Setup and Hold Time

Read Operation

A read operation, defined as data going from the ADNS-5050 to the micro-controller, is always initiated by the micro-controller and consists of two bytes. The first byte contains the address, is sent by the micro-controller over SDIO, and has a "0" as its MSB to indicate data direction. The second byte contains the data and is driven by the ADNS-5050 over SDIO. The sensor outputs SDIO bits on falling edges of SCLK and samples SDIO bits on every rising edge of SCLK.

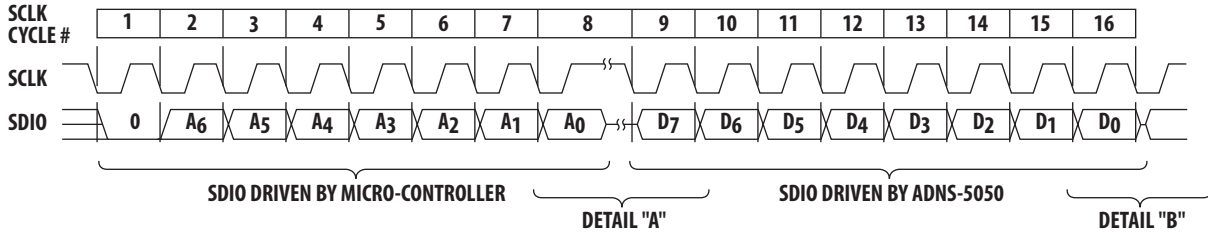

Read Operation

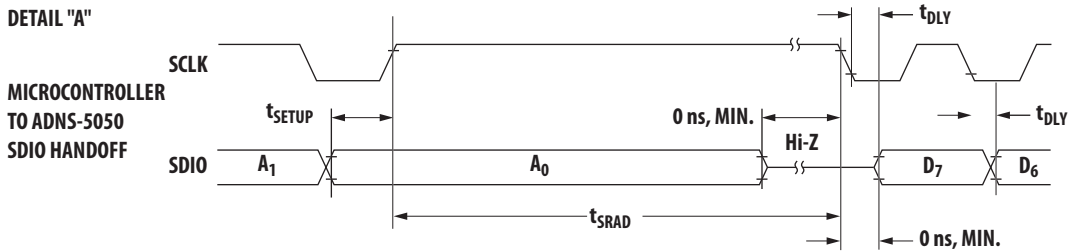

Microcontroller to ADNS-5050 Handoff

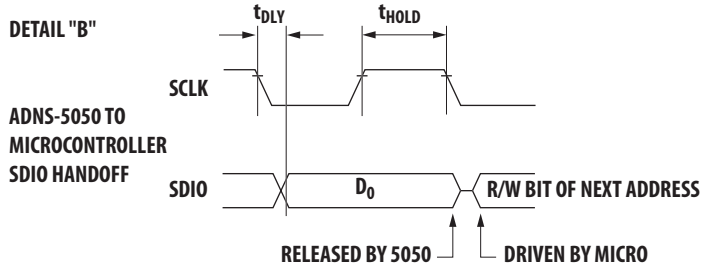

ADNS-5050 to Microcontroller Handoff

NOTE:

The $0.5/f_{SCLK}$ minimum high state of SCLK is also the minimum SDIO data hold time of the ADNS-5050. Since the falling edge of SCLK is actually the start of the next read or write command, the ADNS-5050 will hold the state of data on SDIO until the falling edge of SCLK.

Required Timing between Read and Write Commands

There are minimum timing requirements between read and write commands on the serial port.

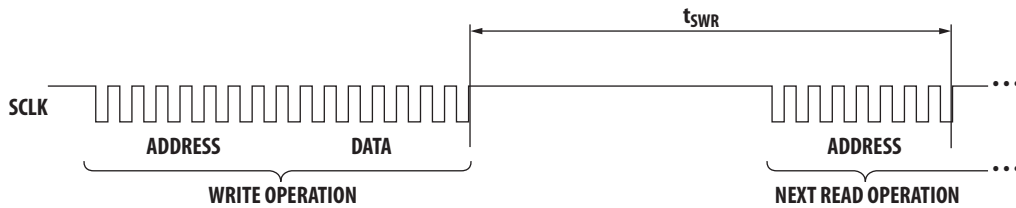

Timing between Two Write Commands

If the rising edge of the SCLK for the last data bit of the second write command occurs before the required delay (t_{SWW}), then the first write command may not complete correctly.

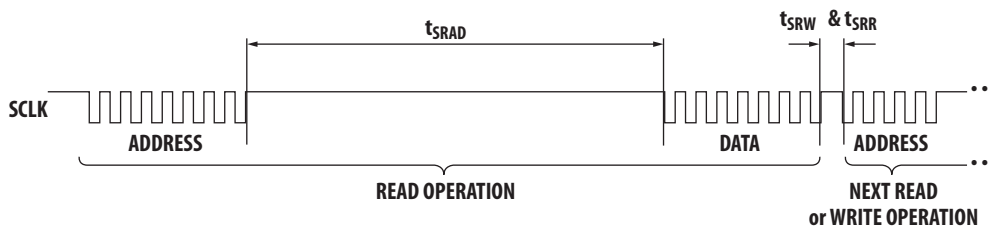

Timing between Write and Read Commands

If the rising edge of SCLK for the last address bit of the read command occurs before the required delay (t_{SWR}), the write command may not complete correctly.

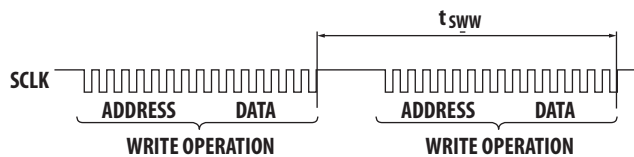

Timing between Read and Either Write or Subsequent Read Commands

During a read operation SCLK should be delayed at least t_{SRAD} after the last address data bit to ensure that the ADNS-5050 has time to prepare the requested data. The falling edge of SCLK for the first address bit of either the read or write command must be at least t_{SRR} or t_{SRW} after the last SCLK rising edge of the last data bit of the previous read operation.

Motion Burst Timing

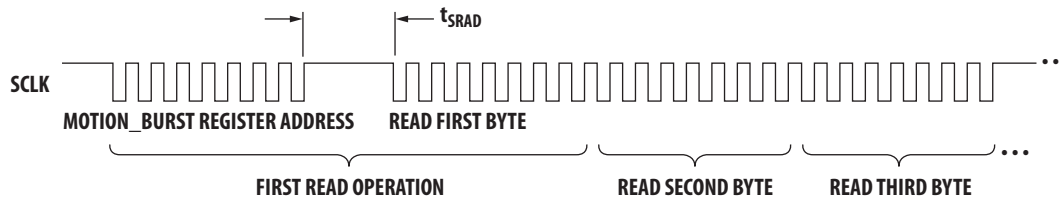

Burst Mode Operation

Burst mode is a special serial port operation mode that may be used to reduce the serial transaction time for a motion read. The speed improvement is achieved by continuous data clocking to or from multiple registers without the need to specify the register address, and by not requiring the normal delay period between data bytes.

Burst mode is activated by reading the Motion_Burst register. The ADNS-5050 will respond with the contents of the Delta_X, Delta_Y, SQUAL, Shutter_Upper, Shutter_Lower, Maximum_Pixel and Pixel_Sum registers in that order. The burst transaction can be terminated anywhere in the sequence after the Delta_X value by bringing the NCS pin high. After sending the register address, the micro-controller must wait t_{SRAD} and then begin reading data. All data bits can be read with no delay between bytes by driving SCLK at the normal rate. The data are latched into the output buffer after the last address bit is received. After the burst transmission is complete, the micro-controller must raise the NCS line for at least t_{BEXIT} to terminate burst mode. The serial port is not available for use until it is reset with NCS, even for a second burst transmission.

Avago Technologies highly recommends the usage of burst mode operation in optical mouse sensor design applications.

Notes on Power-up and Reset

The ADNS-5050 does not perform an internal power up self-reset. There are two ways to reset the chip, either assert low NRESET pin or by writing 0x5a to register 0x3a. A full reset will thus be executed. Any register settings must then be reloaded.

During power-up there will be a period of time after the power supply is high but before any clocks are available. The table below shows the state of the various pins during power-up and reset.

State of Signal Pins After V_{DD} is Valid

Pin	During Reset	After Reset
NCS	Ignored	Functional
SDIO	Ignored	Depends on NCS
SCLK	Ignored	Depends on NCS
XY_LED	Hi-Z	Functional

Notes on Power Down

The ADNS-5050 can be set in Power Down mode by setting bit 1 of register 0x0d. In addition, the SPI port should not be accessed during power down. (Other ICs on the same SPI bus can be accessed, as long as the sensor's NCS pin is not asserted.) The table below shows the state of various pins during power down. There are 2 ways to exit power down, either assert low NRESET pin or by writing 0x5a to Register 0x3a. A full reset will thus be executed. Wait for t_{WAKEUP} before accessing the SPI port. Any register settings must then be reloaded.

Pin	Power Down Active
NRESET	Functional
NCS	Functional*
SDIO	Functional*
SCLK	Functional*
XY_LED	Power Down

* NCS pin must be held to 1(high) if SPI bus is shared with other devices. It can be in either state if the sensor is the only device in addition to the controller microprocessor.

NOTE: There is long wakeup time from power down.

Registers

The ADNS-5050 registers are accessible via the serial port. The registers are used to read motion data and status as well as to set the device configuration.

Address	Register	Read/Write	Default Value
0x00	Product_ID	R	0x12
0x01	Revision_ID	R	0x01
0x02	Motion	R	0x00
0x03	Delta_X	R	Any
0x04	Delta_Y	R	Any
0x05	SQUAL	R	Any
0x06	Shutter_Upper	R	Any
0x07	Shutter_Lower	R	Any
0x08	Maximum_Pixel	R	Any
0x09	Pixel_Sum	R	Any
0x0a	Minimum_Pixel	R	Any
0x0b	Pixel_Grab	R/W	Any
0x0c	Reserved		
0x0d	Mouse_Control	R/W	0x00
0x0e – 0x18	Reserved		
0x19	Mouse_Control2	R/W	0x08
0x1a – 0x21	Reserved		
0x22	LED_DC_Mode	R/W	0x00
0x23 – 0x39	Reserved		
0x3a	Chip_Reset	W	N/A
0x3b – 0x3d	Reserved		
0x3e	Product ID2	R	0x26
0x3f	Inv_Rev_ID	R	0xfe
0x40 – 0x62	Reserved		
0x63	Motion_Burst	R	0x00

Product_ID **Address: 0x00**
 Access: Read Reset Value: 0x12

Bit	7	6	5	4	3	2	1	0
Field	PID ₇	PID ₆	PID ₅	PID ₄	PID ₃	PID ₂	PID ₁	PID ₀

Data Type: 8-Bit unsigned integer

USAGE: This register value is made to be the same as ADNS-5020-EN for direct replacement. The alternative PID is located at Product_ID2 (Address 0x3e). The values in these registers do not change; either one can be used to verify if the serial communications link is functional.

Revision_ID **Address: 0x01**
 Access: Read Reset Value: 0x01

Bit	7	6	5	4	3	2	1	0
Field	RID ₇	RID ₆	RID ₅	RID ₄	RID ₃	RID ₂	RID ₁	RID ₀

Data Type: 8-Bit unsigned integer

USAGE: This register contains the IC revision. It is subject to change when new IC versions are released.

Motion **Address: 0x02**
 Access: Read/Write Reset Value: 0x00

Bit	7	6	5	4	3	2	1	0
Field	MOT	Reserved	Reserved	Reserved	Reserved	Reserved	Reserved	Reserved

Data Type: Bit field.

USAGE: Register 0x02 allows the user to determine if motion has occurred since the last time it was read. If the MOT bit is set, then the user should read registers 0x03 and 0x04 to get the accumulated motion. Read this register before reading the Delta_X and Delta_Y registers. Writing anything to this register clears the MOT bit, Delta_X and Delta_Y registers. The written data byte is not saved.

Field Name	Description
MOT	Motion since last report 0 = No motion 1 = Motion occurred, data ready for reading in Delta_X and Delta_Y registers
Reserved	Reserved

Delta_X Address: 0x03
 Access: Read Reset Value: 0x00

Bit	7	6	5	4	3	2	1	0
Field	X ₇	X ₆	X ₅	X ₄	X ₃	X ₂	X ₁	X ₀

Data Type: Eight bit 2's complement number.

USAGE: X movement is counts since last report. Absolute value is determined by resolution. Reading clears the register.

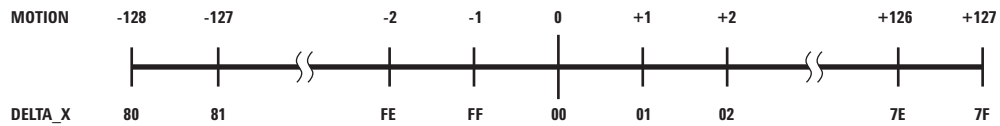

NOTE: Register 0x03 MUST be read prior to Register 0x04.

Delta_Y Address: 0x04
 Access: Read Reset Value: 0x00

Bit	7	6	5	4	3	2	1	0
Field	Y ₇	Y ₆	Y ₅	Y ₄	Y ₃	Y ₂	Y ₁	Y ₀

Data Type: Eight bit 2's complement number.

USAGE: Y movement is counts since last report. Absolute value is determined by resolution. Reading clears the register.

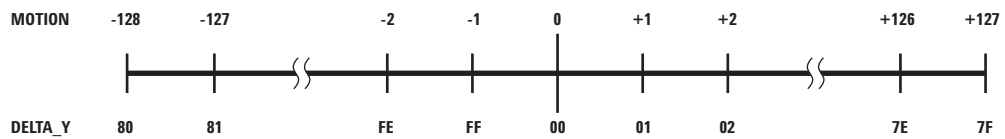

NOTE: Register 0x03 MUST be read prior to Register 0x04.

SQUAL Address: 0x05
 Access: Read Reset Value: 0x00

Bit	7	6	5	4	3	2	1	0
Field	SQ ₇	SQ ₆	SQ ₅	SQ ₄	SQ ₃	SQ ₂	SQ ₁	SQ ₀

Data Type: Upper 8 bits of a 9-bit unsigned integer.

USAGE: SQUAL (Surface Quality) is a measure of the number of valid features visible by the sensor in the current frame. The maximum SQUAL register value is 128. Since small changes in the current frame can result in changes in SQUAL, variations in SQUAL when looking at a surface are expected. The graph below shows few sequentially acquired SQUAL values, while a sensor was moved slowly over white paper. SQUAL is nearly equal to zero, if there is no surface below the sensor. SQUAL is typically maximized when the navigation surface is at the optimum distance from the imaging lens (the nominal Z-height).

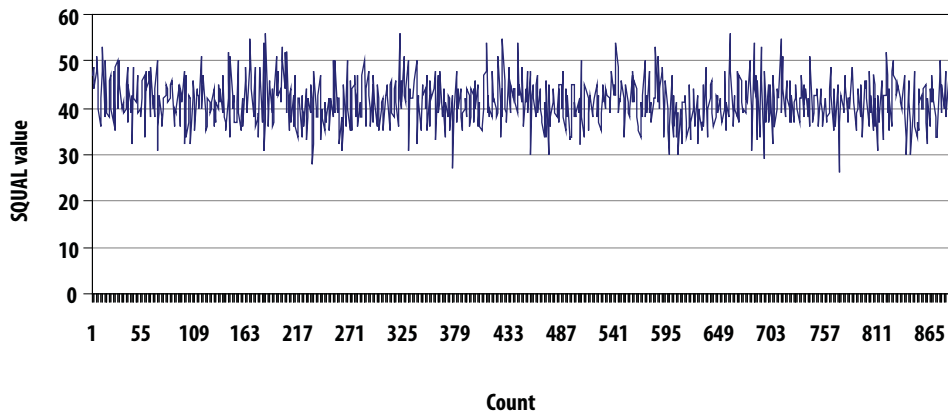

Figure 13. Squal values (white paper).

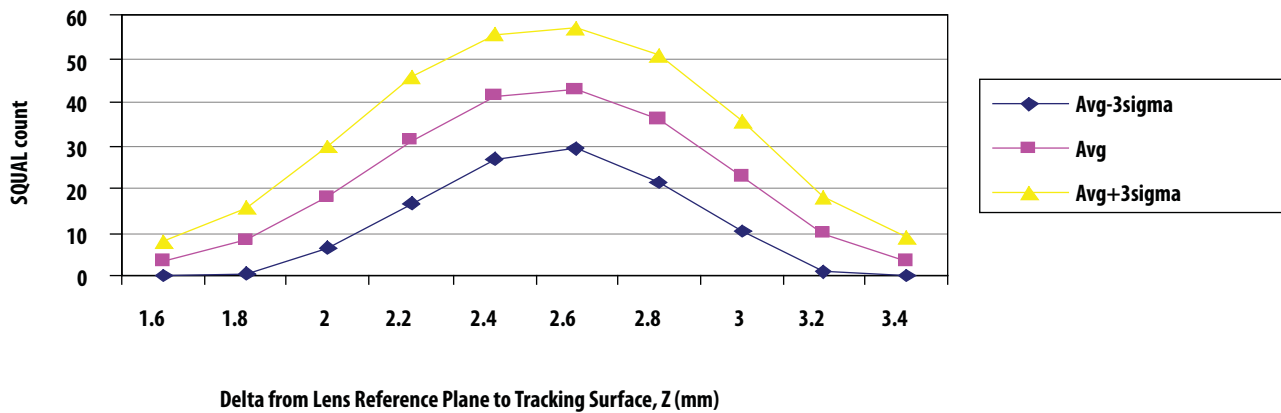

Figure 14. Mean squal vs. Z (white paper).

Shutter_Upper **Address: 0x06**
 Access: Read Reset Value: 0x00

Bit	7	6	5	4	3	2	1	0
Field	S ₁₅	S ₁₄	S ₁₃	S ₁₂	S ₁₁	S ₁₀	S ₉	S ₈

Shutter_Lower **Address: 0x07**
 Access: Read Reset Value: 0x00

Bit	7	6	5	4	3	2	1	0
Field	S ₇	S ₆	S ₅	S ₄	S ₃	S ₂	S ₁	S ₀

Data Type: Sixteen bit unsigned integer.

USAGE: Units are clock cycles. They must be read in this order: Read 0x06 first, then 0x07. The shutter is continuously adjusted to keep the average and maximum pixel values within normal operating range. The shutter value is automatically adjusted.

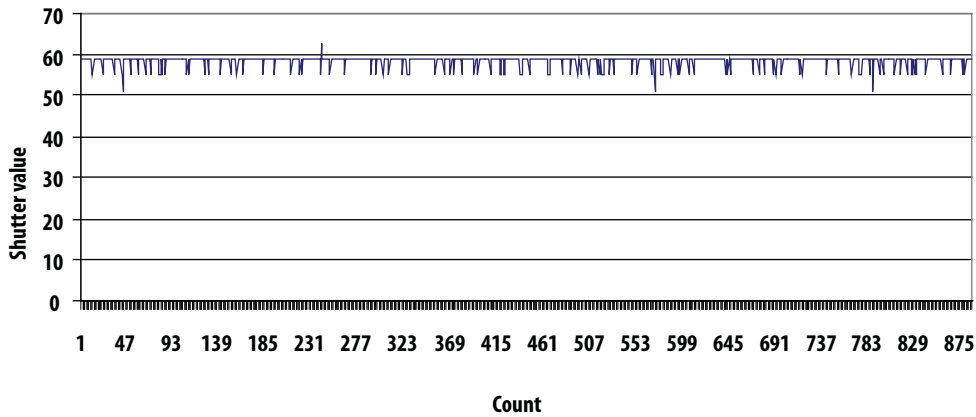

Figure 15. Shutter (white paper).

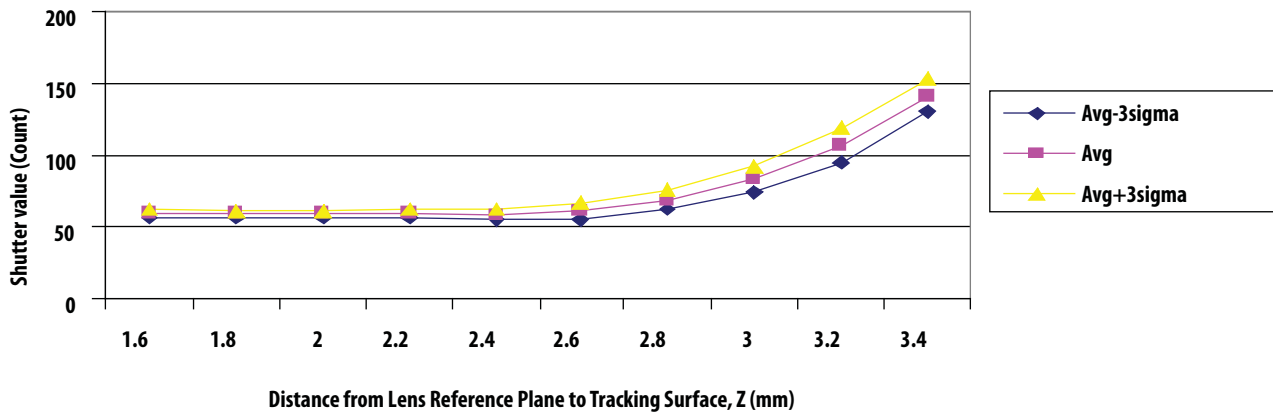

Figure 16. Mean shutter vs. Z (white paper).

Maximum_Pixel **Address: 0x08**
Access: Read Reset Value: 0x00

Bit	7	6	5	4	3	2	1	0
Field	MP ₀	MP ₆	MP ₅	MP ₄	MP ₃	MP ₂	MP ₁	MP ₀

Data Type: Seven-bit number.

USAGE: Maximum Pixel value in current frame. Minimum value = 0, maximum value = 127. The maximum pixel value can vary with every frame.

Pixel_Sum **Address: 0x09**
Access: Read Reset Value: 0x00

Bit	7	6	5	4	3	2	1	0
Field	AP ₇	AP ₆	AP ₅	AP ₄	AP ₃	AP ₂	AP ₁	AP ₀

Data Type: High 8 bits of an unsigned 15-bit integer.

USAGE: This register is the accumulated pixel value from the last image taken. The maximum accumulator value is 45,847, but only bits [14:7] are reported. It may be described as the full sum divided by 1.41. The maximum register value is 179. The minimum is 0. The pixel sum value can change on every frame

Minimum_Pixel **Address: 0x0a**
Access: Read **Reset Value: 0x00**

Bit	7	6	5	4	3	2	1	0
Field	MP ₀	MP ₆	MP ₅	MP ₄	MP ₃	MP ₂	MP ₁	MP ₀

Data Type: Seven-bit number..

USAGE: Minimum Pixel value in current frame. Minimum value = 0, maximum value = 127. The minimum pixel value can vary with every frame.

Pixel_Grab Address: 0x0b
 Access: Read/Write Reset Value: 0x00

Bit	7	6	5	4	3	2	1	0
Field	Valid	PD ₆	PD ₅	PD ₄	PD ₃	PD ₂	PD ₁	PD ₀

Data Type: Eight-bit word.

USAGE: The pixel grabber captures 1 pixel per frame. If there is a valid pixel in the grabber when this register is read, the MSB will be set, an internal counter will be incremented to capture the next pixel and the grabber will be armed to capture the next pixel. It will take 361 reads to upload the complete image. Any write to this register will reset and arm the grabber to grab pixel 0 on the next image.

Physical Pixel Address Map – readout order of the array
 (looking through the sensor aperture at the bottom of the package)

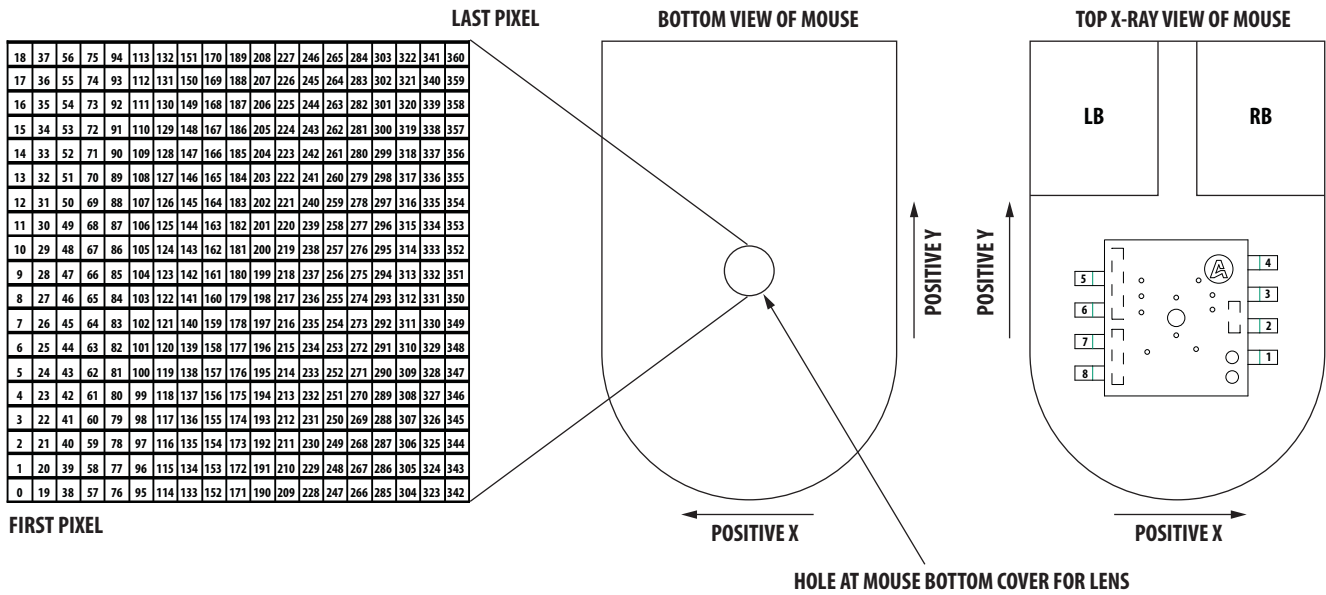

Reserved **Address: 0x1a-0x21**

LED_DC_Mode **Address: 0x22**
Access: Read/Write Reset Value: 0x00

Bit	7	6	5	4	3	2	1	0
Field	LM ₇	LM ₆	LM ₅	LM ₄	LM ₃	LM ₂	LM ₁	LM ₀

Data Type: 8-Bit unsigned integer

USAGE: Write 0x80 to this register to force LED into Always DC mode.

Reserved **Address: 0x23-0x39**

Chip_Reset **Address: 0x3a**
Access: Write Reset Value: 0x00

Bit	7	6	5	4	3	2	1	0
Field	CR ₇	CR ₆	CR ₅	CR ₄	CR ₃	CR ₂	CR ₁	CR ₀

Data Type: 8-Bit unsigned integer

USAGE: Write 0x5a to initiate chip RESET.

Reserved **Address: 0x23-0x39**

Product_ID2 **Address: 0x3e**
Access: Read Reset Value: 0x26

Bit	7	6	5	4	3	2	1	0
Field	PID ₇	PID ₆	PID ₅	PID ₄	PID ₃	PID ₂	PID ₁	PID ₀

Data Type: 8-Bit unsigned integer

USAGE: This register contains a unique identification assigned to the ADNS-5050. The value in this register does not change; it can be used to verify that the serial communications link is functional.

Inv_Rev_ID Address: 0x3f
Access: Read Reset Value: 0xfe

Bit	7	6	5	4	3	2	1	0
Field	RRID ₇	RRID ₆	RRID ₅	RRID ₄	RRID ₃	RRID ₂	RRID ₁	RRID ₀

Data Type: 8-Bit unsigned integer

USAGE: This register contains the inverse of the revision ID which is located at register 0x01..

Reserved Address: 0x40-0x62

Motion_Burst Address: 0x63
Access: Read Reset Value: 0x00

Bit	7	6	5	4	3	2	1	0
Field	MB ₇	MB ₆	MB ₅	MB ₄	MB ₃	MB ₂	MB ₁	MB ₀

Data Type: Various.

USAGE: Read from this register to activate burst mode. The sensor will return the data in the Delta_X, Delta_Y, SQUAL, Shutter_Upper, Shutter_Lower, Maximum_Pixel and Pixel_Sum. If the burst is not terminated at this point, the internal address counter stops incrementing and Pixel Sum register's value will be continuously returned. Bursts are terminated when NCS is raised.



For product information and a complete list of distributors, please go to our website: www.avagotech.com

Avago, Avago Technologies, and the A logo are trademarks of Avago Technologies in the United States and other countries.
Data subject to change. Copyright © 2005-2012 Avago Technologies. All rights reserved.
AV02-1045EN - April 25, 2012



Looking for pricing, stock, or lifecycle information?

Click below to explore more details on WIN SOURCE:

-  [View ADNS-5050 on WIN SOURCE](#)
-  [Broadcom Limited](#) Information

Optimize Your Supply Chain with WIN SOURCE Solutions

-  Global Sourcing Solution
-  Obsolete Management
-  Cost Control Management
-  Shortage Management
-  Alternative Solution
-  Excess Inventory Management