



**THE DATASHEET OF
ADP150AUJZ-3.3-R7**



Ultralow Noise, 150 mA, CMOS Linear Regulator

FEATURES

- ▶ Ultralow noise: 9 μV rms, independent of V_{OUT}
- ▶ No additional noise bypass capacitor required
- ▶ Stable with 1 μF ceramic input and output capacitors
- ▶ Maximum output current: 150 mA
- ▶ Input voltage range: 2.2 V to 5.5 V
- ▶ Low quiescent current
 - ▶ $I_{\text{GND}} = 10 \mu\text{A}$ with zero load
- ▶ Low shutdown current: $<1 \mu\text{A}$
- ▶ Low dropout voltage: 105 mV at 150 mA load
- ▶ Initial output voltage accuracy: $\pm 1\%$
- ▶ Up to 14 fixed output voltage options: 1.8 V to 3.3 V
- ▶ PSRR performance of 70 dB at 10 kHz
- ▶ Current limit and thermal overload protection
- ▶ Logic-controlled enable
- ▶ [5-lead TSOT package](#)
- ▶ [4-ball, 0.8 mm \$\times\$ 0.8 mm, 0.4 mm pitch WLCSP](#)
- ▶ AEC-Q100 qualified for automotive applications

APPLICATIONS

- ▶ Mobile phones
- ▶ Digital camera and audio devices
- ▶ Portable and battery-powered equipment
- ▶ Post dc-to-dc regulation
- ▶ Portable medical devices
- ▶ RF, voltage controlled oscillator (VCO), and phase locked loop (PLL) power supplies

GENERAL DESCRIPTION

The ADP150 is an ultralow noise (9 μV), low dropout, linear regulator that operates from 2.2 V to 5.5 V and provides up to 150 mA of output current. The low 105 mV dropout voltage at 150 mA load improves efficiency and allows operation over a wide input voltage range.

Using an innovative circuit topology, the ADP150 achieves ultralow noise performance without the necessity of an additional noise bypass capacitor, making it ideal for noise sensitive analog and RF applications. The ADP150 also achieves ultralow noise performance without compromising PSRR or line and load transient performance. The ADP150 offers the best combination of ultralow noise and quiescent current consumption to maximize battery life in portable applications.

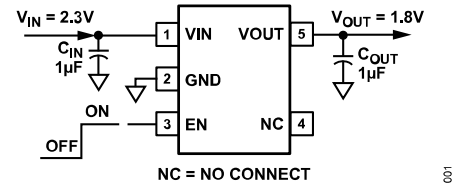
TYPICAL APPLICATION CIRCUITS


Figure 1. 5-Lead TSOT with Fixed Output Voltage, 1.8 V

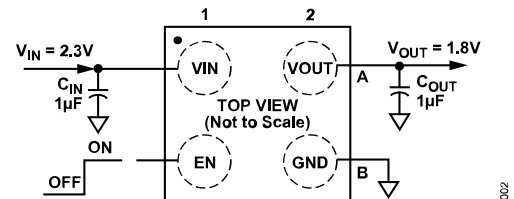


Figure 2. 4-Ball WLCSP with Fixed Output Voltage, 1.8 V

The ADP150 is specifically designed for stable operation with tiny 1 $\mu\text{F} \pm 30\%$ ceramic input and output capacitors to meet the requirements of high performance, space-constrained applications.

The ADP150 is available in 14 fixed output voltage options, ranging from 1.8 V to 3.3 V.

Short-circuit and thermal overload protection circuits prevent damage in adverse conditions. The ADP150 is available in tiny [5-lead TSOT](#) and [4-ball, 0.4 mm pitch WLCSP packages](#) for the smallest footprint solution to meet a variety of portable power applications.

TABLE OF CONTENTS

Features.....	1	Applications Information.....	12
Applications.....	1	Capacitor Selection.....	12
Typical Application Circuits.....	1	Undervoltage Lockout.....	13
General Description.....	1	Enable Feature.....	13
Specifications.....	3	Current Limit and Thermal Overload	
Recommended Specifications: Input and		Protection.....	13
Output Capacitor.....	4	Thermal Considerations.....	14
Absolute Maximum Ratings.....	5	PCB Layout Considerations.....	17
Thermal Data.....	5	Outline Dimensions.....	18
Thermal Resistance.....	5	Ordering Guide	18
ESD Caution.....	5	Output Voltage Options.....	19
Pin Configurations and Function Descriptions.....	6	Evaluation Boards.....	19
Typical Performance Characteristics.....	7	Automotive Products	19
Theory of Operation.....	11		

REVISION HISTORY**11/2022—Rev. D to Rev. E**

Changes to Applications Section.....	1
Changes to Undervoltage Lockout Parameter, Table 1.....	3
Changes to Figure 12 and Figure 14.....	8
Changes to Figure 49.....	18
Changes to Ordering Guide.....	18
Changes to Evaluation Board	19

SPECIFICATIONS

$V_{IN} = (V_{OUT} + 0.4 \text{ V})$ or 2.2 V, whichever is greater; $EN = V_{IN}$, $I_{OUT} = 10 \text{ mA}$, $C_{IN} = C_{OUT} = 1 \mu\text{F}$, $T_A = 25^\circ\text{C}$, unless otherwise noted.

Table 1.

Parameter	Symbol	Test Conditions/Comments	Min	Typ	Max	Unit
INPUT VOLTAGE RANGE	V_{IN}	$T_J = -40^\circ\text{C}$ to $+125^\circ\text{C}$	2.2		5.5	V
OPERATING SUPPLY CURRENT	I_{GND}	$I_{OUT} = 0 \mu\text{A}$		10		μA
		$I_{OUT} = 0 \mu\text{A}$, $T_J = -40^\circ\text{C}$ to $+125^\circ\text{C}$			22	μA
		$I_{OUT} = 100 \mu\text{A}$		20		μA
		$I_{OUT} = 100 \mu\text{A}$, $T_J = -40^\circ\text{C}$ to $+125^\circ\text{C}$			40	μA
		$I_{OUT} = 10 \text{ mA}$		60		μA
		$I_{OUT} = 10 \text{ mA}$, $T_J = -40^\circ\text{C}$ to $+125^\circ\text{C}$			100	μA
		$I_{OUT} = 150 \text{ mA}$		220		μA
SHUTDOWN CURRENT	I_{GND-SD}	$EN = \text{GND}$		0.2		μA
		$EN = \text{GND}$, $T_J = -40^\circ\text{C}$ to $+125^\circ\text{C}$			1.0	μA
OUTPUT VOLTAGE ACCURACY 5-Lead TSOT	V_{OUT}	$I_{OUT} = 10 \text{ mA}$	-1		+1	%
		$100 \mu\text{A} < I_{OUT} < 150 \text{ mA}$, $V_{IN} = (V_{OUT} + 0.4 \text{ V})$ to 5.5 V, $T_J = -40^\circ\text{C}$ to $+125^\circ\text{C}$	-2.5		+1.5	%
4-Ball WLCSP	V_{OUT}	$I_{OUT} = 10 \text{ mA}$	-1		+1	%
		$100 \mu\text{A} < I_{OUT} < 150 \text{ mA}$, $V_{IN} = (V_{OUT} + 0.4 \text{ V})$ to 5.5 V, $T_J = -40^\circ\text{C}$ to $+125^\circ\text{C}$	-2.0		+1.5	%
REGULATION Line Regulation Load Regulation ¹	$\Delta V_{OUT}/\Delta V_{IN}$	$V_{IN} = (V_{OUT} + 0.4 \text{ V})$ to 5.5 V, $T_J = -40^\circ\text{C}$ to $+125^\circ\text{C}$	-0.05		+0.05	%/V
	$\Delta V_{OUT}/\Delta I_{OUT}$	$I_{OUT} = 100 \mu\text{A}$ to 150 mA $I_{OUT} = 100 \mu\text{A}$ to 150 mA, $T_J = -40^\circ\text{C}$ to $+125^\circ\text{C}$		0.003		%/mA
					0.0075	%/mA
4-Ball WLCSP	$\Delta V_{OUT}/\Delta I_{OUT}$	$I_{OUT} = 100 \mu\text{A}$ to 150 mA $I_{OUT} = 100 \mu\text{A}$ to 150 mA, $T_J = -40^\circ\text{C}$ to $+125^\circ\text{C}$		0.002		%/mA
					0.006	%/mA
DROPOUT VOLTAGE ²	$V_{DROPOUT}$	$I_{OUT} = 10 \text{ mA}$		10		mV
		$I_{OUT} = 10 \text{ mA}$, $T_J = -40^\circ\text{C}$ to $+125^\circ\text{C}$			35	mV
		$I_{OUT} = 150 \text{ mA}$		105		mV
		$I_{OUT} = 150 \text{ mA}$, $T_J = -40^\circ\text{C}$ to $+125^\circ\text{C}$			160	mV
START-UP TIME ³	$T_{START-UP}$	$V_{OUT} = 3.3 \text{ V}$		150		μs
CURRENT-LIMIT THRESHOLD ⁴	I_{LIMIT}		190	260	400	mA
		W grade, $T_J = -40^\circ\text{C}$ to $+125^\circ\text{C}$	155	260	400	mA
UNDERVOLTAGE LOCKOUT Input Voltage Rising	$UVLO_{RISE}$	$T_J = -40^\circ\text{C}$ to $+125^\circ\text{C}$ W grade			1.96	V
					1.86	V
	Input Voltage Falling Hysteresis	$UVLO_{FALL}$ $UVLO_{HYS}$		1.28		115
THERMAL SHUTDOWN Thermal Shutdown Threshold Thermal Shutdown Hysteresis	TS_{SD} TS_{SD-HYS}	T_J rising		150		$^\circ\text{C}$
				15		$^\circ\text{C}$
EN INPUT EN Input Logic High EN Input Logic Low	V_{IH} V_{IL}	$2.2 \text{ V} \leq V_{IN} \leq 5.5 \text{ V}$ $2.2 \text{ V} \leq V_{IN} \leq 5.5 \text{ V}$	1.2			V
						0.4

SPECIFICATIONS

Table 1. (Continued)

Parameter	Symbol	Test Conditions/Comments	Min	Typ	Max	Unit
EN Input Leakage Current	$V_{I-LEAKAGE}$	EN = IN or GND		0.001		μA
		EN = IN or GND, $T_J = -40^{\circ}C$ to $+125^{\circ}C$			1	μA
OUTPUT NOISE	OUT_{NOISE}	10 Hz to 100 kHz, $V_{IN} = 5 V$, $V_{OUT} = 3.3 V$		9		μV rms
		10 Hz to 100 kHz, $V_{IN} = 5 V$, $V_{OUT} = 2.5 V$		9		μV rms
		10 Hz to 100 kHz, $V_{IN} = 5 V$, $V_{OUT} = 1.8 V$		9		μV rms
POWER SUPPLY REJECTION RATIO ($V_{IN} = V_{OUT} + 0.5 V$)	PSRR	10 kHz, $V_{IN} = 3.8 V$, $V_{OUT} = 3.3 V$, $I_{OUT} = 10 mA$		70		dB
		10 kHz, $V_{IN} = 2.3 V$, $V_{OUT} = 1.8 V$, $I_{OUT} = 10 mA$		70		dB
		100 kHz, $V_{IN} = 3.8 V$, $V_{OUT} = 3.3 V$, $I_{OUT} = 10 mA$		55		dB
		100 kHz, $V_{IN} = 2.3 V$, $V_{OUT} = 1.8 V$, $I_{OUT} = 10 mA$		55		dB
POWER SUPPLY REJECTION RATIO ($V_{IN} = V_{OUT} + 1 V$)		10 kHz, $V_{IN} = 4.3 V$, $V_{OUT} = 3.3 V$, $I_{OUT} = 10 mA$		70		dB
		100 kHz, $V_{IN} = 4.3 V$, $V_{OUT} = 3.3 V$, $I_{OUT} = 10 mA$		55		dB

- Based on an end-point calculation using 1 mA and 150 mA loads. See Figure 6 for typical load regulation performance for loads less than 1 mA.
- Dropout voltage is defined as the input-to-output voltage differential when the input voltage is set to the nominal output voltage. This applies only for output voltages above 2.2 V.
- Start-up time is defined as the time between the rising edges of EN to V_{OUT} being at 90% of its nominal value.
- Current limit threshold is defined as the current at which the output voltage drops to 90% of the specified typical value. For example, the current limit for a 3.0 V output voltage is defined as the current that causes the output voltage to drop to 90% of 3.0 V or 2.7 V.

RECOMMENDED SPECIFICATIONS: INPUT AND OUTPUT CAPACITOR

Table 2.

Parameter	Symbol	Test Conditions/Comments	Min	Typ	Max	Unit
INPUT AND OUTPUT CAPACITOR						
Minimum Input and Output Capacitance ¹	C_{MIN}	$T_A = -40^{\circ}C$ to $+125^{\circ}C$	0.7			μF
Capacitor ESR	R_{ESR}	$T_A = -40^{\circ}C$ to $+125^{\circ}C$	0.001		0.2	Ω

- The minimum input and output capacitance should be greater than 0.7 μF over the full range of operating conditions. The full range of operating conditions in the application must be considered during device selection to ensure that the minimum capacitance specification is met. X7R-type and X5R-type capacitors are recommended, and Y5V and Z5U capacitors are not recommended for use with any LDO.

ABSOLUTE MAXIMUM RATINGS

Table 3.

Parameter	Rating
VIN to GND	-0.3 V to +6.5 V
VOUT to GND	-0.3 V to VIN
EN to GND	-0.3 V to +6.5 V
Temperature Range	
Storage	-65°C to +150°C
Operating Junction	-40°C to +125°C
Operating Ambient	-40°C to +85°C
Soldering Conditions	JEDEC J-STD-020

Stresses at or above those listed under Absolute Maximum Ratings may cause permanent damage to the product. This is a stress rating only; functional operation of the product at these or any other conditions above those indicated in the operational section of this specification is not implied. Operation beyond the maximum operating conditions for extended periods may affect product reliability.

THERMAL DATA

Absolute maximum ratings apply individually only, not in combination. The ADP150 can be damaged when the junction temperature limits are exceeded. Monitoring ambient temperature does not guarantee that T_J is within the specified temperature limits. In applications with high power dissipation and poor thermal resistance, the maximum ambient temperature may have to be derated.

In applications with moderate power dissipation and low printed circuit board (PCB) thermal resistance, the maximum ambient temperature can exceed the maximum limit as long as the junction temperature is within specification limits. The junction temperature (T_J) of the device is dependent on the ambient temperature (T_A), the power dissipation of the device (P_D), and the junction-to-ambient thermal resistance of the package (θ_{JA}).

Maximum junction temperature (T_J) is calculated from the ambient temperature (T_A) and power dissipation (P_D) by

$$T_J = T_A + (P_D \times \theta_{JA})$$

The junction to ambient thermal resistance (θ_{JA}) of the package is based on modeling and a calculation using a 4-layer board. The junction to ambient thermal resistance is highly dependent on the application and board layout. In applications where high maximum

power dissipation exists, close attention to thermal board design is required. The value of θ_{JA} can vary, depending on PCB material, layout, and environmental conditions. The specified values of θ_{JA} are based on a 4-layer, 4 inch × 3 inch circuit board. Refer to JESD 51-7 and JESD 51-9 for detailed information on the board construction. For additional information, see the [AN-617 Application Note, Wafer Level Chip Scale Package](#).

Ψ_{JB} is the junction-to-board thermal characterization parameter with units of °C/W. Ψ_{JB} of the package is based on modeling and a calculation using a 4-layer board. The JESD51-12, *Guidelines for Reporting and Using Package Thermal Information*, states that thermal characterization parameters are not the same as thermal resistances. Ψ_{JB} measures the component power flowing through multiple thermal paths rather than a single path as in thermal resistance, θ_{JB} . Therefore, Ψ_{JB} thermal paths include convection from the top of the package as well as radiation from the package, factors that make Ψ_{JB} more useful in real-world applications. Maximum junction temperature (T_J) is calculated from the board temperature (T_B) and power dissipation (P_D) by

$$T_J = T_B + (P_D \times \Psi_{JB})$$

Refer to JESD51-8 and JESD51-12 for more detailed information about Ψ_{JB} .

THERMAL RESISTANCE

θ_{JA} and Ψ_{JB} are specified for the worst-case conditions, that is, a device soldered in a circuit board for surface-mount packages.

Table 4. Thermal Resistance

Package Type	θ_{JA}	Ψ_{JB}	Unit
5-Lead TSOT	170	43	°C/W
4-Ball, 0.4 mm Pitch WLCSP	260	58	°C/W

ESD CAUTION



ESD (electrostatic discharge) sensitive device. Charged devices and circuit boards can discharge without detection. Although this product features patented or proprietary protection circuitry, damage may occur on devices subjected to high energy ESD. Therefore, proper ESD precautions should be taken to avoid performance degradation or loss of functionality.

PIN CONFIGURATIONS AND FUNCTION DESCRIPTIONS

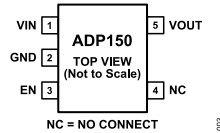


Figure 3. 5-Lead TSOT Pin Configuration

Table 5. 5-Lead TSOT Pin Function Descriptions

Pin No.	Mnemonic	Description
1	VIN	Regulator Input Supply. Bypass VIN to GND with a 1 μ F or greater capacitor.
2	GND	Ground.
3	EN	Enable Input. Drive EN high to turn on the regulator; drive EN low to turn off the regulator. For automatic startup, connect EN to VIN.
4	NC	No Connect. Not connected internally.
5	VOUT	Regulated Output Voltage. Bypass VOUT to GND with a 1 μ F or greater capacitor.

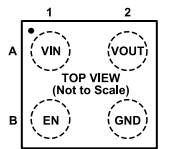


Figure 4. 4-Ball WLCSP Pin Configuration

Table 6. 4-Ball WLCSP Pin Function Descriptions

Pin No.	Mnemonic	Description
A1	VIN	Regulator Input Supply. Bypass VIN to GND with a 1 μ F or greater capacitor.
A2	VOUT	Regulated Output Voltage. Bypass VOUT to GND with a 1 μ F or greater capacitor.
B1	EN	Enable Input. Drive EN high to turn on the regulator; drive EN low to turn off the regulator. For automatic startup, connect EN to VIN.
B2	GND	Ground.

TYPICAL PERFORMANCE CHARACTERISTICS

$V_{IN} = 3.7\text{ V}$, $V_{OUT} = 3.3\text{ V}$, $I_{OUT} = 1\text{ mA}$, $C_{IN} = C_{OUT} = 1\text{ }\mu\text{F}$, $T_A = 25^\circ\text{C}$, unless otherwise noted.

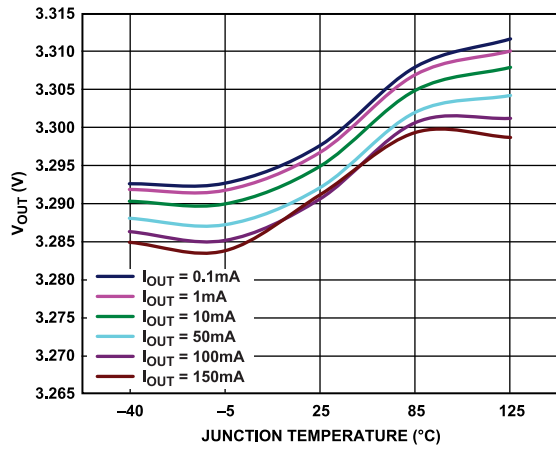


Figure 5. Output Voltage (V_{OUT}) vs. Junction Temperature

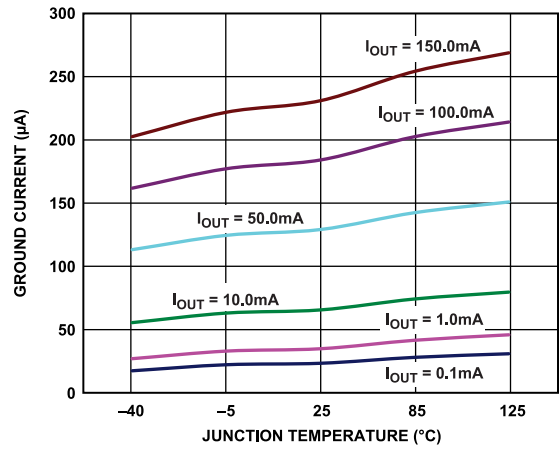


Figure 8. Ground Current vs. Junction Temperature

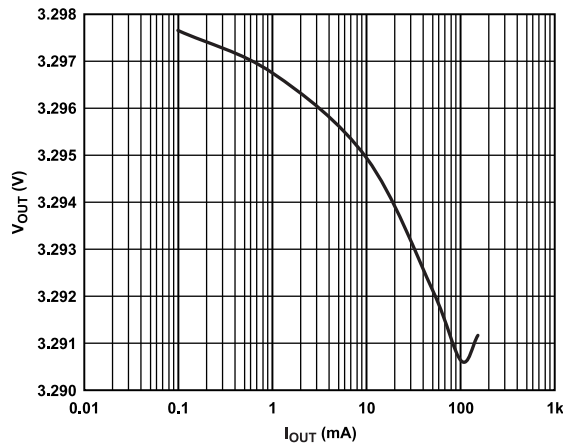


Figure 6. Output Voltage (V_{OUT}) vs. Load Current (I_{OUT})

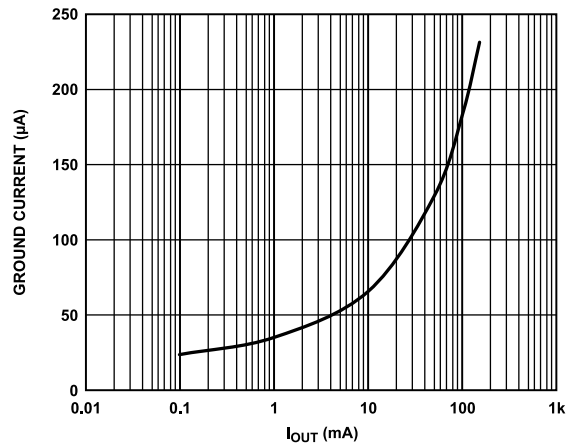


Figure 9. Ground Current vs. Load Current (I_{OUT})

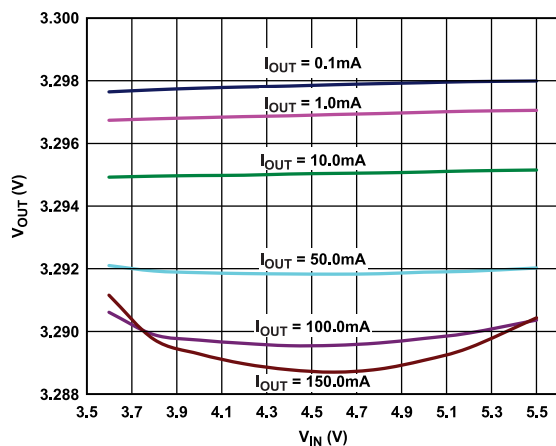


Figure 7. Output Voltage (V_{OUT}) vs. Input Voltage (V_{IN})

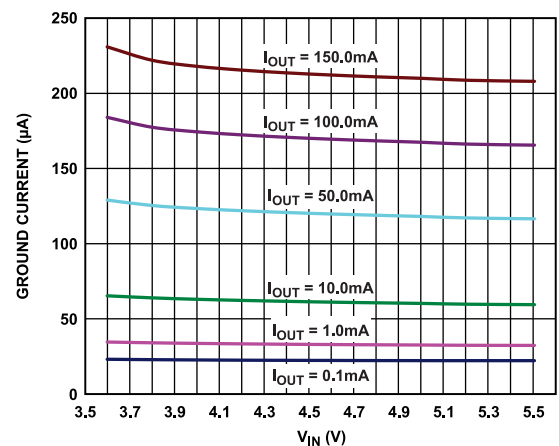


Figure 10. Ground Current vs. Input Voltage (V_{IN})

TYPICAL PERFORMANCE CHARACTERISTICS

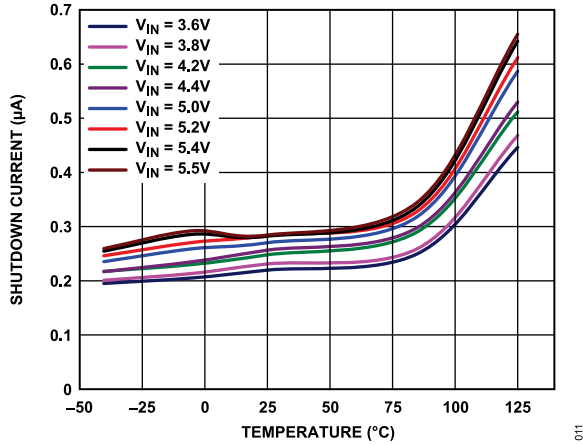


Figure 11. Shutdown Current vs. Temperature at Various Input Voltages

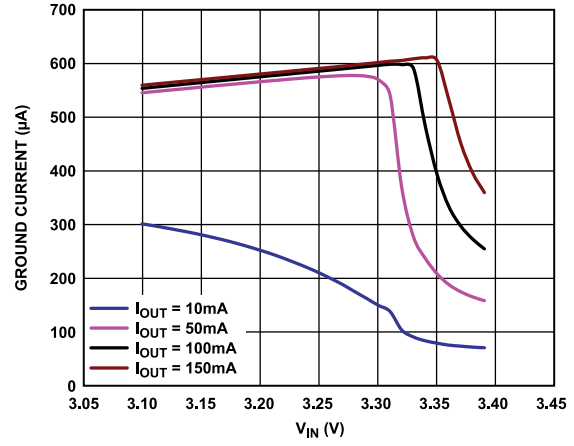


Figure 14. Ground Current vs. Input Voltage (V_{IN}) in Dropout

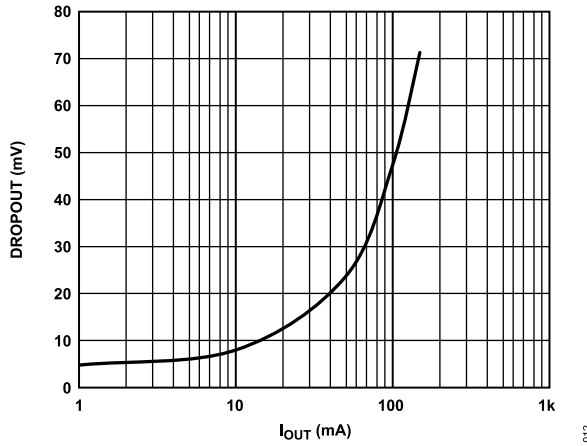


Figure 12. Dropout Voltage vs. Load Current (I_{LOAD})

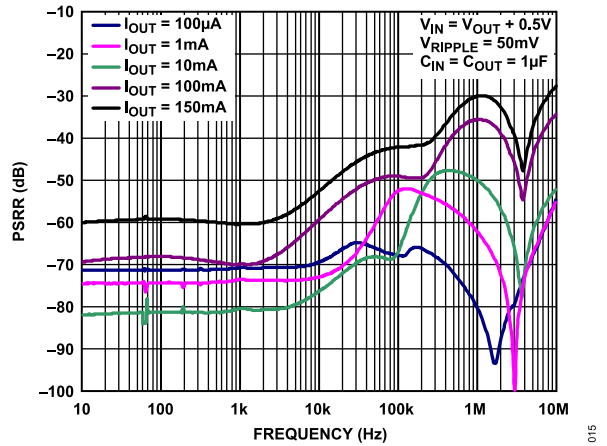


Figure 15. Power Supply Rejection Ratio (PSRR) vs. Frequency, $V_{OUT} = 1.8 V$, $V_{IN} = 2.3 V$

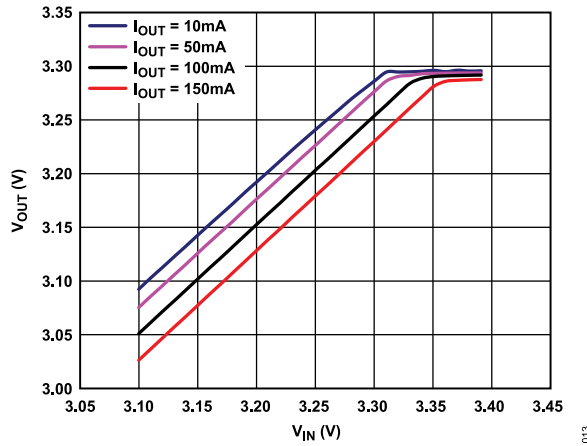


Figure 13. Output Voltage (V_{OUT}) vs. Input Voltage (V_{IN}) in Dropout

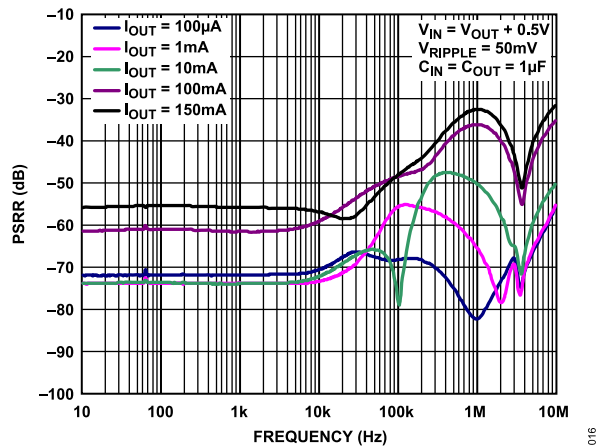


Figure 16. Power Supply Rejection Ratio (PSRR) vs. Frequency, $V_{OUT} = 2.8 V$, $V_{IN} = 3.3 V$

TYPICAL PERFORMANCE CHARACTERISTICS

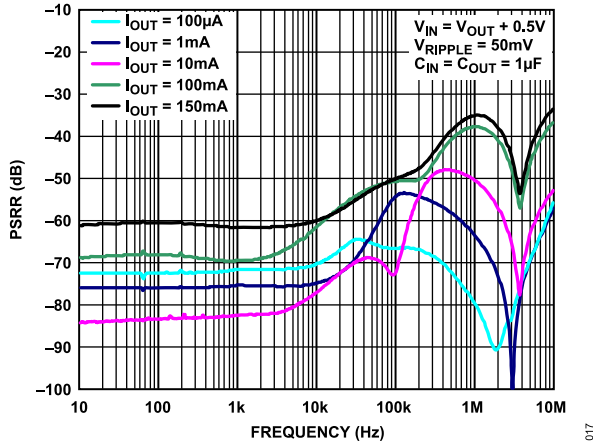


Figure 17. Power Supply Rejection Ratio (PSRR) vs. Frequency, $V_{OUT} = 3.3\text{ V}$, $V_{IN} = 3.8\text{ V}$

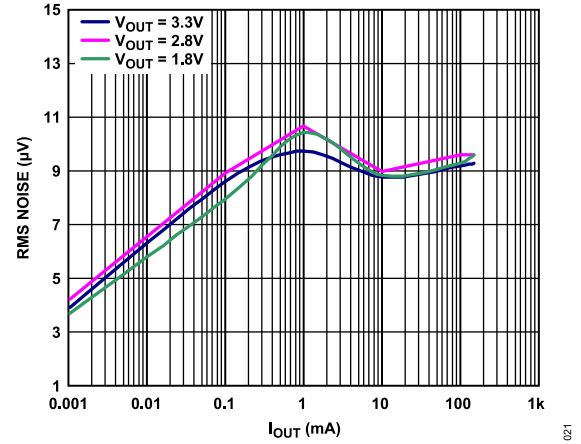


Figure 20. Output RMS Noise vs. Load Current (I_{OUT}) and Output Voltage (V_{OUT}), $V_{IN} = 5\text{ V}$, $C_{OUT} = 1\text{ }\mu\text{F}$

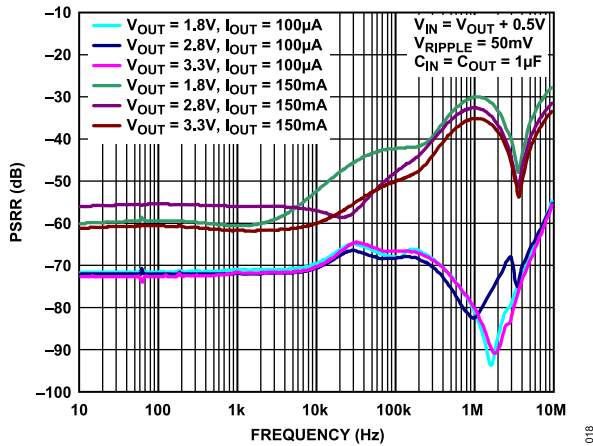


Figure 18. Power Supply Rejection Ratio (PSRR) vs. Frequency Various Output Voltages and Load Currents

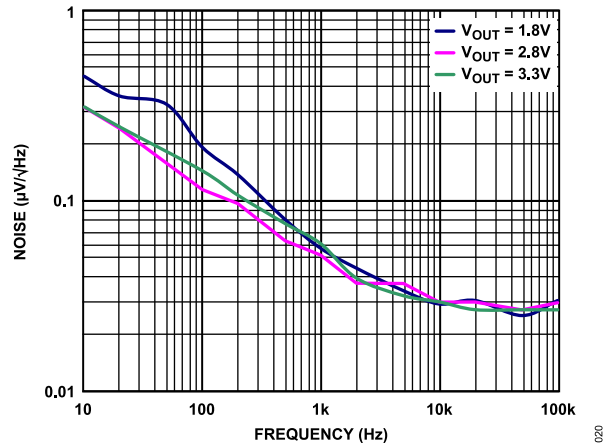


Figure 21. Output Noise Spectrum, $V_{IN} = 5\text{ V}$, $I_{LOAD} = 10\text{ mA}$, $C_{OUT} = 1\text{ }\mu\text{F}$

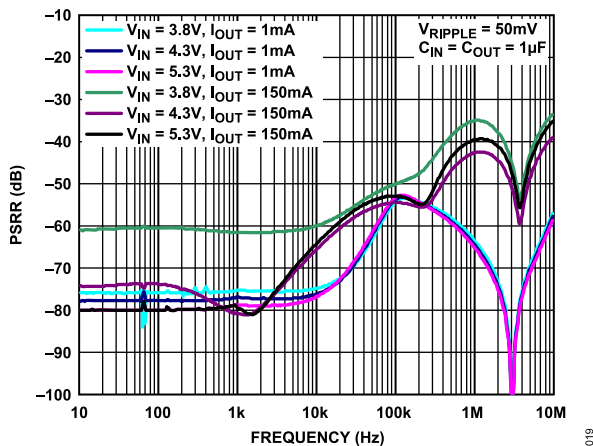


Figure 19. Power Supply Rejection Ratio (PSRR) vs. Frequency with Various Headroom Voltages ($V_{IN} - V_{OUT}$), $V_{OUT} = 3.3\text{ V}$

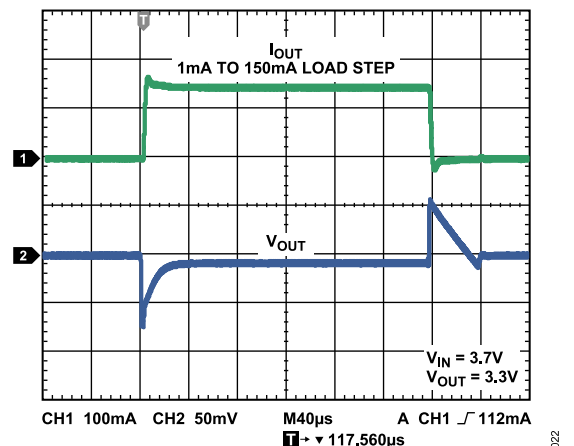


Figure 22. Load Transient Response, $C_{OUT} = 1\text{ }\mu\text{F}$

TYPICAL PERFORMANCE CHARACTERISTICS

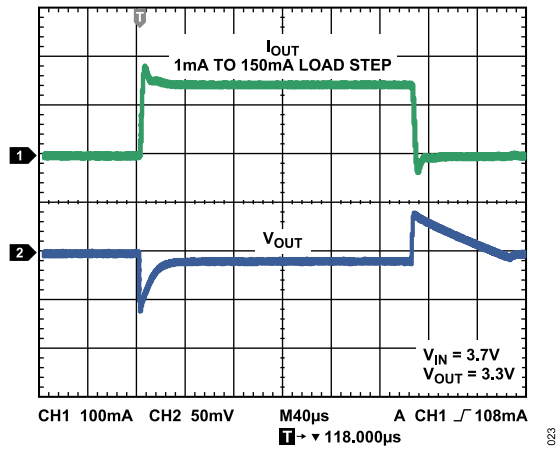


Figure 23. Load Transient Response, $C_{OUT} = 4.7 \mu F$

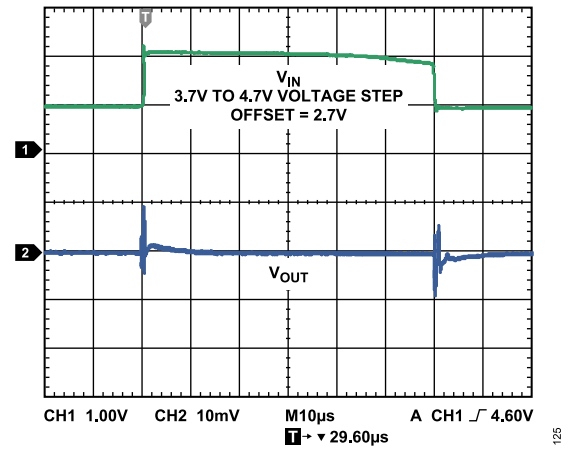


Figure 25. Line Transient Response, $C_{IN}, C_{OUT} = 1 \mu F, I_{LOAD} = 150 \text{ mA}$

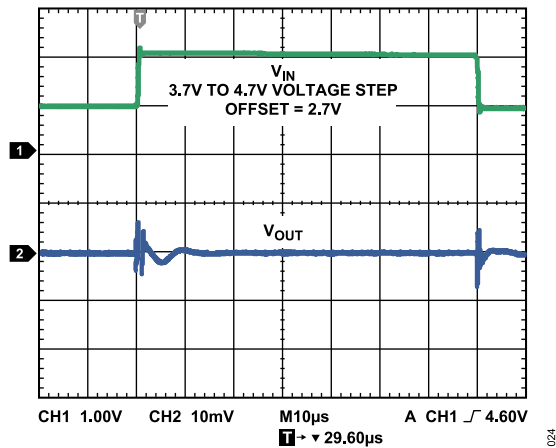


Figure 24. Line Transient Response, $C_{IN}, C_{OUT} = 1 \mu F, I_{LOAD} = 1 \text{ mA}$

THEORY OF OPERATION

The ADP150 is an ultralow noise, low quiescent current, low dropout linear regulator that operates from 2.2 V to 5.5 V and can provide up to 150 mA of output current. Drawing a low 220 μA of quiescent current (typical) at full load makes the ADP150 ideal for battery-operated portable equipment. Shutdown current consumption is typically 200 nA.

Using a proprietary architecture, the ADP150 provides superior noise performance for noise sensitive analog and RF applications without the need for a noise bypass capacitor. The ADP150 is also optimized for use with small 1 μF ceramic capacitors.

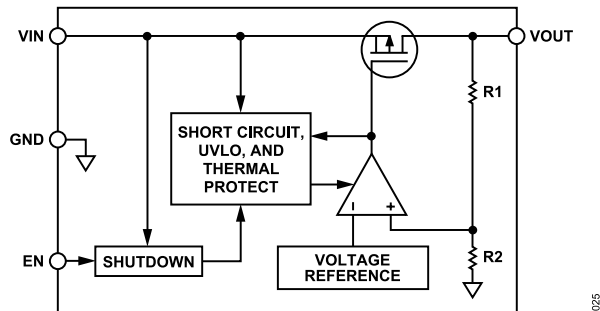


Figure 26. Internal Block Diagram

Internally, the ADP150 consists of a reference, an error amplifier, a feedback voltage divider, and a PMOS pass transistor. Output current is delivered via the PMOS pass device that is controlled by the error amplifier. The error amplifier compares the reference voltage with the feedback voltage from the output and amplifies the difference. If the feedback voltage is lower than the reference voltage, the gate of the PMOS device is pulled lower, allowing more current to pass and increasing the output voltage. If the feedback voltage is higher than the reference voltage, the gate of the PMOS device is pulled higher, allowing less current to pass and decreasing the output voltage.

The ADP150 is available in 14 output voltage options, ranging from 1.8 V to 3.3 V. The ADP150 uses the EN pin to enable and disable the VOUT pin under normal operating conditions. When EN is high, VOUT turns on, and when EN is low, VOUT turns off. For automatic startup, EN can be tied to VIN.

APPLICATIONS INFORMATION

CAPACITOR SELECTION

Output Capacitor

The ADP150 is designed for operation with small, space-saving ceramic capacitors but functions with most commonly used capacitors as long as care is taken with regard to the effective series resistance (ESR) value. The ESR of the output capacitor affects the stability of the LDO control loop. A minimum of 1 μF capacitance with an ESR of 1 Ω or less is recommended to ensure the stability of the ADP150. The transient response to changes in load current is also affected by output capacitance. Using a larger value of output capacitance improves the transient response of the ADP150 to large changes in the load current. Figure 27 and Figure 28 show the transient responses for output capacitance values of 1 μF and 4.7 μF , respectively.

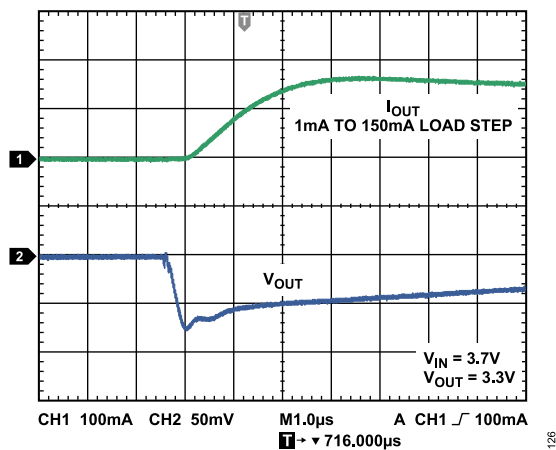


Figure 27. Output Transient Response, $C_{OUT} = 1 \mu\text{F}$

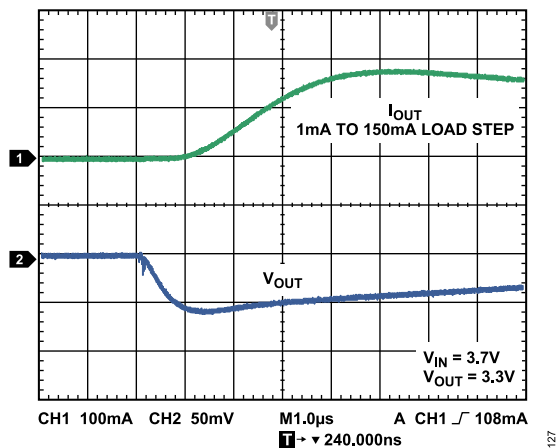


Figure 28. Output Transient Response, $C_{OUT} = 4.7 \mu\text{F}$

Input Bypass Capacitor

Connecting a 1 μF capacitor from V_{IN} to GND reduces the circuit sensitivity to the PCB layout, especially when long input traces or high source impedance is encountered. If greater than 1 μF

of output capacitance is required, increase the input capacitor to match the output capacitor.

Input and Output Capacitor Properties

Any good quality ceramic capacitors can be used with the ADP150, as long as they meet the minimum capacitance and maximum ESR requirements. Ceramic capacitors are manufactured with a variety of dielectrics, each with different behavior over temperature and applied voltage. Capacitors must have a dielectric adequate to ensure the minimum capacitance over the necessary temperature range and dc bias conditions. X5R or X7R dielectrics with a voltage rating of 6.3 V or 10 V are recommended. Y5V and Z5U dielectrics are not recommended, due to their poor temperature and dc bias characteristics.

Figure 29 depicts the capacitance vs. the voltage bias characteristic of a 0402, 1 μF , 10 V, X5R capacitor. The voltage stability of a capacitor is strongly influenced by the capacitor size and voltage rating. In general, a capacitor in a larger package or higher voltage rating exhibits better stability. The temperature variation of the X5R dielectric is about $\pm 15\%$ over the -40°C to $+85^\circ\text{C}$ temperature range and is not a function of package or voltage rating.

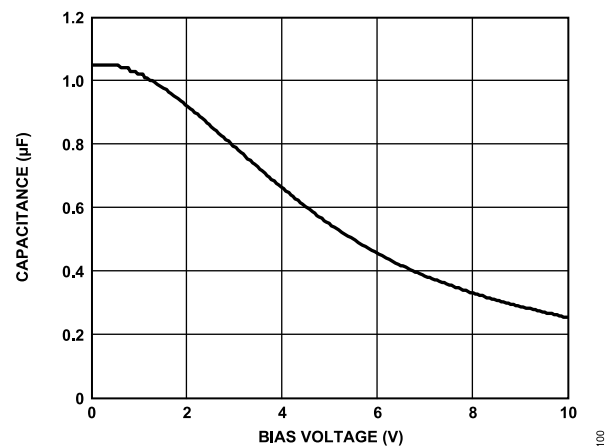


Figure 29. Capacitance vs. Voltage Bias Characteristic

Use Equation 1 to determine the worst-case capacitance, accounting for capacitor variation over temperature, component tolerance, and voltage.

$$C_{EFF} = C_{BIAS} \times (1 - TEMPCO) \times (1 - TOL) \quad (1)$$

where:

C_{BIAS} is the effective capacitance at the operating voltage.

$TEMPCO$ is the worst-case capacitor temperature coefficient.

TOL is the worst-case component tolerance.

In this example, the worst-case temperature coefficient ($TEMPCO$) over -40°C to $+85^\circ\text{C}$ is assumed to be 15% for an X5R dielectric. The tolerance of the capacitor (TOL) is assumed to be 10%, and the C_{BIAS} is 0.94 μF at 1.8 V, as shown in Figure 29.

Substituting these values in Equation 1 yields

APPLICATIONS INFORMATION

$$C_{EFF} = 0.94 \mu\text{F} \times (1 - 0.15) \times (1 - 0.1) = 0.719 \mu\text{F}$$

Therefore, the capacitor chosen in this example meets the minimum capacitance requirement of the LDO over temperature and tolerance at the chosen output voltage.

To guarantee the performance of the ADP150, it is imperative that the effects of the dc bias, temperature, and tolerances on the behavior of the capacitors be evaluated for each.

UNDERVOLTAGE LOCKOUT

The ADP150 has an internal undervoltage lockout circuit that disables all inputs and the output when the input voltage is less than approximately 2.0 V. This ensures that the ADP150 inputs and output behave in a predictable manner during power-up.

ENABLE FEATURE

The ADP150 uses the EN pin to enable and disable the V_{OUT} pin under normal operating conditions. As shown in Figure 30, when a rising voltage on EN crosses the active threshold, V_{OUT} turns on. When a falling voltage on EN crosses the inactive threshold, V_{OUT} turns off.

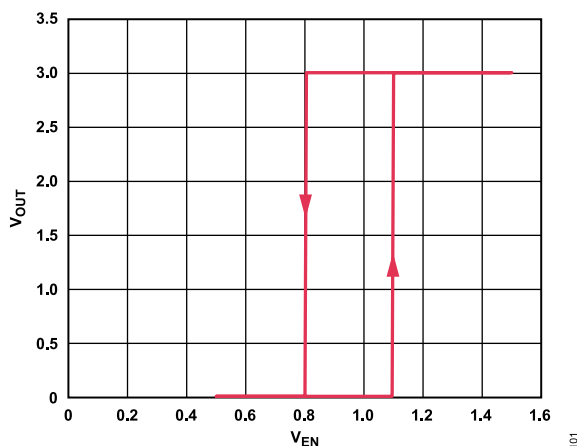


Figure 30. Typical EN Pin Operation

As shown in Figure 30, the EN pin has hysteresis built in. This prevents on/off oscillations that can occur due to noise on the EN pin as it passes through the threshold points.

The EN pin active/inactive thresholds are derived from the V_{IN} voltage; therefore, these thresholds vary with changing input voltage. Figure 31 shows the typical EN active/inactive thresholds when the input voltage varies from 2.2 V to 5.5 V.

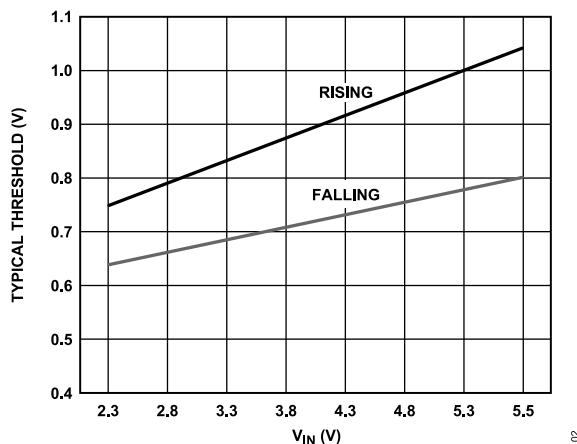


Figure 31. Typical EN Pin Thresholds vs. Input Voltage (V_{IN})

The ADP150 uses an internal soft start to limit the inrush current when the output is enabled. The start-up time for the 3.3 V option is approximately 150 μs from the time the EN active threshold is crossed to when the output reaches 90% of its final value. As shown in Figure 32, the start-up time is dependent on the output voltage setting.

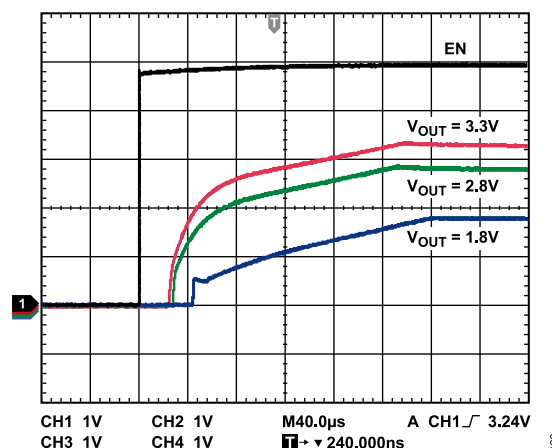


Figure 32. Typical Start-Up Time

CURRENT LIMIT AND THERMAL OVERLOAD PROTECTION

The ADP150 is protected against damage due to excessive power dissipation by current and thermal overload protection circuits. The ADP150 is designed to limit current when the output load reaches 260 mA (typical). When the output load exceeds 260 mA, the output voltage is reduced to maintain a constant current limit.

Thermal overload protection is included, which limits the junction temperature to a maximum of 150°C (typical). Under extreme conditions (that is, high ambient temperature and power dissipation) when the junction temperature starts to rise above 150°C, the output is turned off, reducing the output current to zero. When the junction temperature drops below 135°C, the output is turned on again and the output current is restored to its nominal value.

APPLICATIONS INFORMATION

Consider the case where a hard short from V_{OUT} to GND occurs. At first, the ADP150 limits current so that only 260 mA is conducted into the short. If self-heating of the junction is great enough to cause its temperature to rise above 150°C, thermal shutdown activates, turning off the output and reducing the output current to zero. As the junction temperature cools and drops below 135°C, the output turns on and conducts 260 mA into the short, again causing the junction temperature to rise above 150°C. This thermal oscillation between 135°C and 150°C causes a current oscillation between 260 mA and 0 mA that continues as long as the short remains at the output.

Current and thermal limit protections are intended to protect the device against accidental overload conditions. For reliable operation, device power dissipation must be externally limited so that the junction temperatures do not exceed 125°C.

THERMAL CONSIDERATIONS

In most applications, the ADP150 does not dissipate much heat due to its high efficiency. However, in applications with high ambient temperature and high supply voltage to output voltage differential, the heat dissipated in the package is large enough that it can cause the junction temperature of the die to exceed the maximum junction temperature of 125°C.

When the junction temperature exceeds 150°C, the converter enters thermal shutdown. It recovers only after the junction temperature decreases below 135°C to prevent any permanent damage. Therefore, thermal analysis for the chosen application is very important to guarantee reliable performance over all conditions. The junction temperature of the die is the sum of the ambient temperature of the environment and the temperature rise of the package due to the power dissipation, as shown in Equation 2.

To guarantee reliable operation, the junction temperature of the ADP150 must not exceed 125°C. To ensure that the junction temperature stays below 125°C, be aware of the parameters that contribute to the junction temperature changes. These parameters include ambient temperature, power dissipation in the power device, and thermal resistances between the junction and ambient air (θ_{JA}). The θ_{JA} number is dependent on the package assembly compounds that are used and the amount of copper used to solder the package GND pins to the PCB. Table 7 shows typical θ_{JA} values of the 5-lead TSOT and 4-ball WLCSP packages for various PCB copper sizes. Table 8 shows the typical Ψ_{JB} value of the 5-lead TSOT and 4-ball WLCSP.

Table 7. Typical θ_{JA} Values

Copper Size (mm ²)	θ_{JA} (°C/W)	
	TSOT	WLCSP
0 ¹	170	260
50	152	159
100	146	157
300	134	153

Table 7. Typical θ_{JA} Values (Continued)

Copper Size (mm ²)	θ_{JA} (°C/W)	
	TSOT	WLCSP
500	131	151

¹ Device soldered to minimum size pin traces.

Table 8. Typical Ψ_{JB} Values

TSOT	Ψ_{JB} (°C/W)	
	WLCSP	
42.8	58.4	

Use Equation 2 to calculate the junction temperature.

$$T_J = T_A + (P_D \times \theta_{JA}) \quad (2)$$

where:

T_A is the ambient temperature.

P_D is the power dissipation in the die, given by

$$P_D = ((V_{IN} - V_{OUT}) \times I_{LOAD}) + (V_{IN} \times I_{GND})$$

where:

I_{LOAD} is the load current.

I_{GND} is the ground current.

V_{IN} and V_{OUT} are input and output voltages, respectively.

Power dissipation due to ground current is quite small and can be ignored. Therefore, the junction temperature equation simplifies to

$$T_J = T_A + (((V_{IN} - V_{OUT}) \times I_{LOAD}) \times \theta_{JA}) \quad (3)$$

As shown in the previous equation, for a given ambient temperature, input-to-output voltage differential, and continuous load current, there exists a minimum copper size requirement for the PCB to ensure that the junction temperature does not rise above 125°C. Figure 33 to Figure 46 show the junction temperature calculations for the different ambient temperatures, load currents, V_{IN} -to- V_{OUT} differentials, and areas of PCB copper.

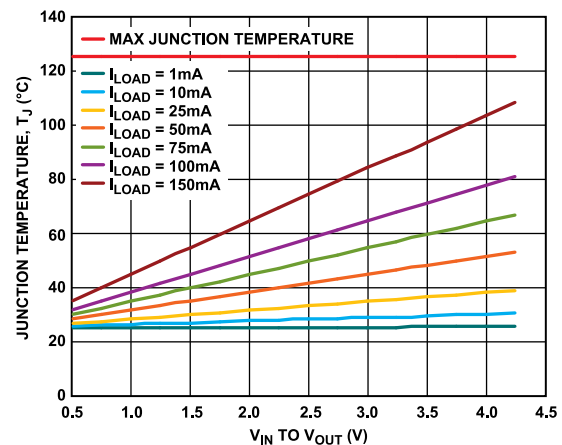


Figure 33. TSOT, 500 mm² of PCB Copper, $T_A = 25^\circ\text{C}$

APPLICATIONS INFORMATION

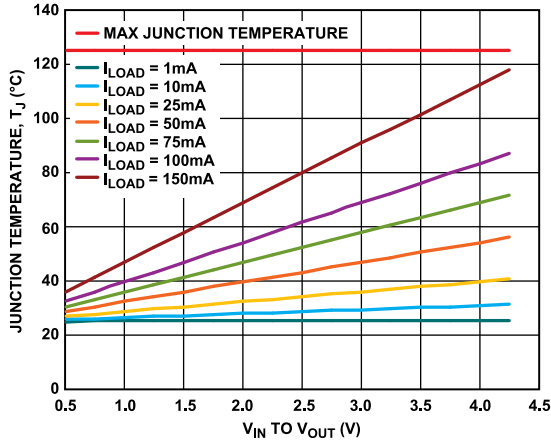


Figure 34. TSOT, 100 mm² of PCB Copper, T_A = 25°C

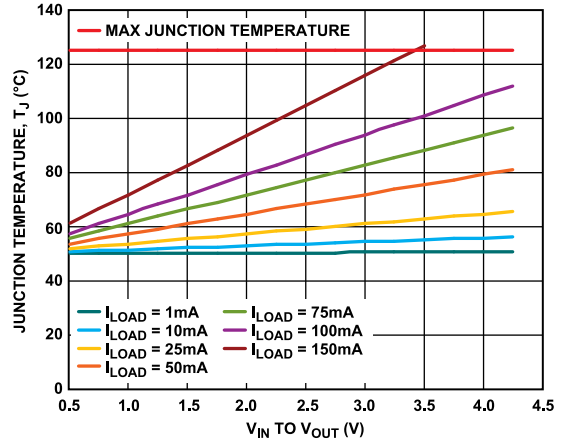


Figure 37. TSOT, 100 mm² of PCB Copper, T_A = 50°C

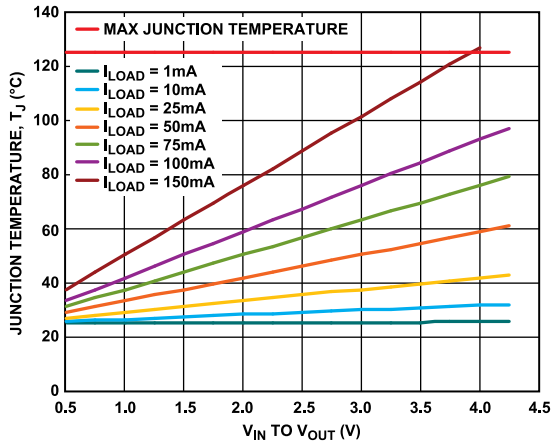


Figure 35. TSOT, 0 mm² of PCB Copper, T_A = 25°C

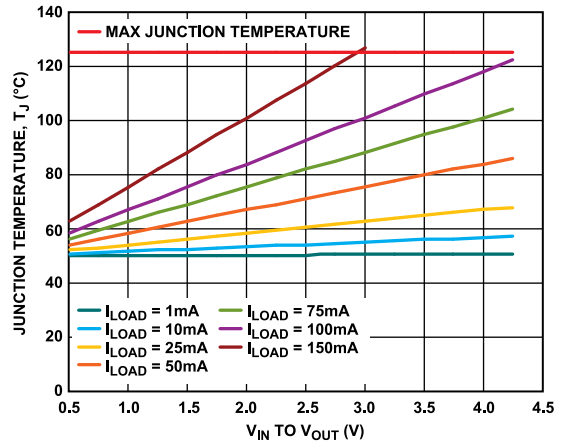


Figure 38. TSOT, 0 mm² of PCB Copper, T_A = 50°C

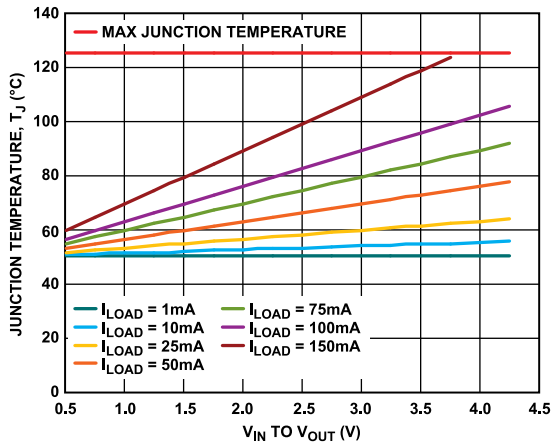


Figure 36. TSOT, 500 mm² of PCB Copper, T_A = 50°C

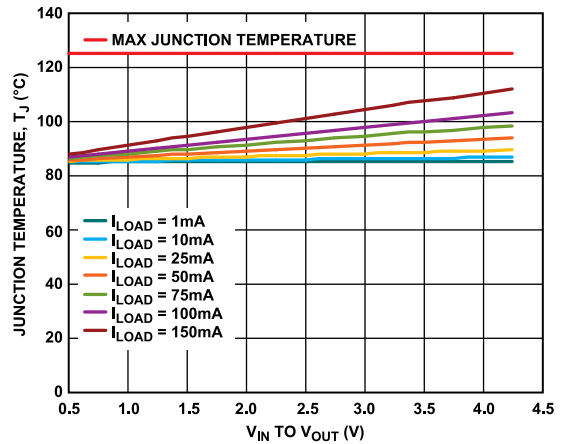


Figure 39. TSOT, 100 mm² of PCB Copper, Board Temperature = 85°C

APPLICATIONS INFORMATION

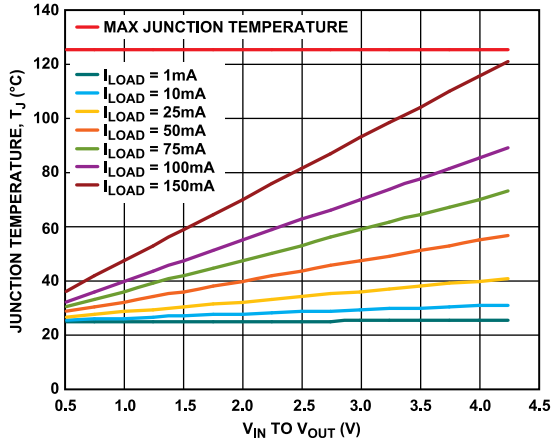


Figure 40. WLCSP, 500 mm² of PCB Copper, $T_A = 25^\circ\text{C}$

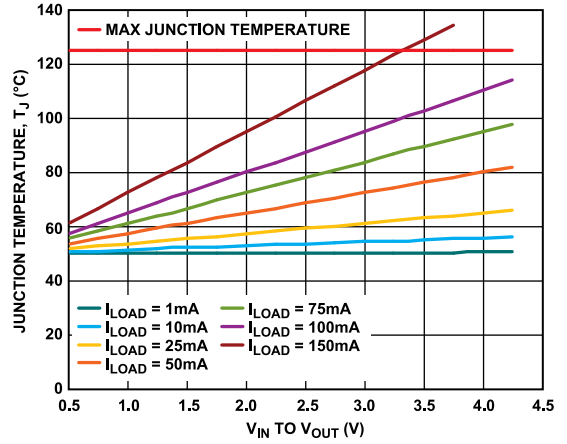


Figure 43. WLCSP, 500 mm² of PCB Copper, $T_A = 50^\circ\text{C}$

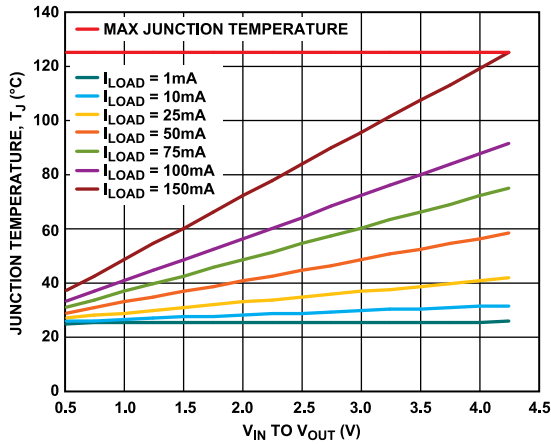


Figure 41. WLCSP, 100 mm² of PCB Copper, $T_A = 25^\circ\text{C}$

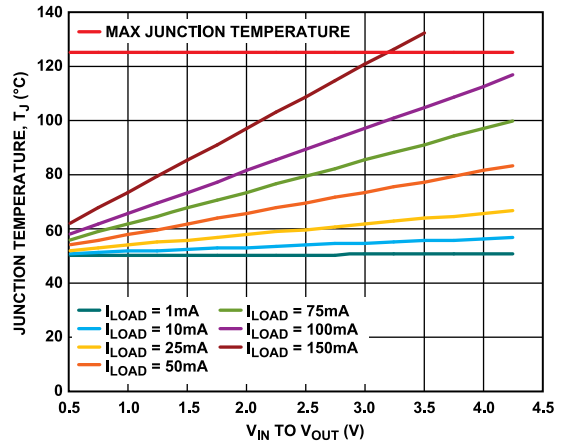


Figure 44. WLCSP, 100 mm² of PCB Copper, $T_A = 50^\circ\text{C}$

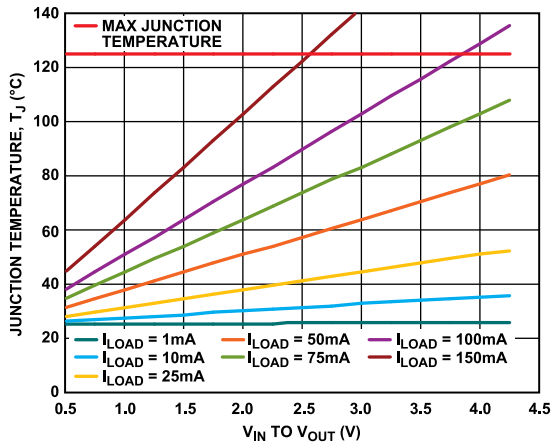


Figure 42. WLCSP, 0 mm² of PCB Copper, $T_A = 25^\circ\text{C}$

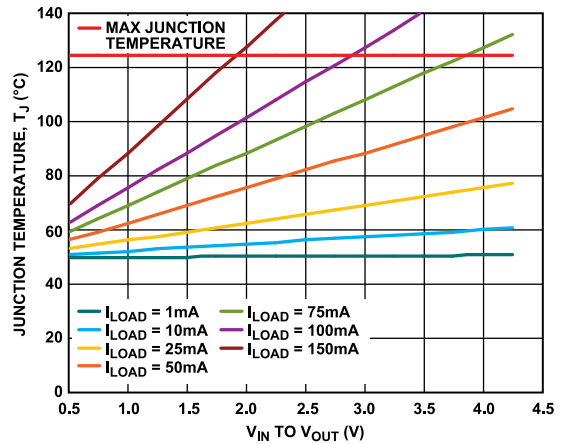


Figure 45. WLCSP, 0 mm² of PCB Copper, $T_A = 50^\circ\text{C}$

APPLICATIONS INFORMATION

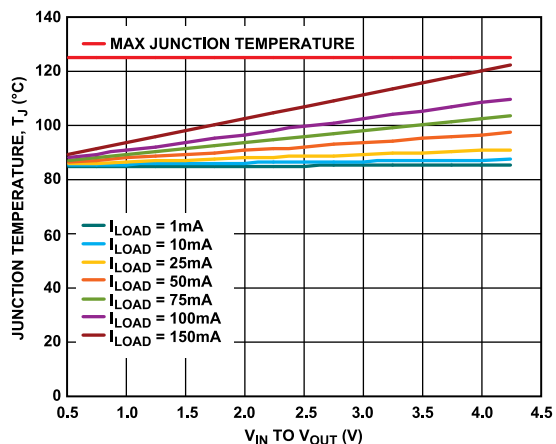


Figure 46. WLCSP, 100 mm² of PCB Copper, Board Temperature = 85°C

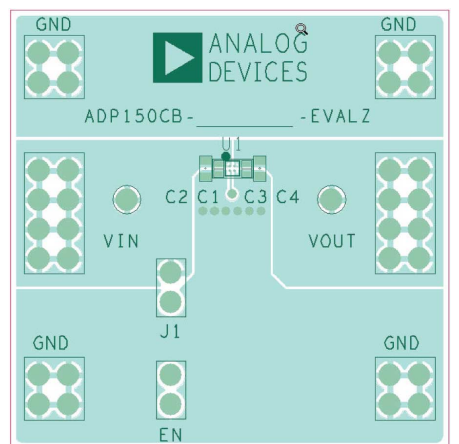


Figure 48. Example WLCSP PCB Layout

PCB LAYOUT CONSIDERATIONS

Heat dissipation from the package can be improved by increasing the amount of copper attached to the pins of the ADP150. However, as listed in Table 7, a point of diminishing returns is reached eventually, beyond which an increase in the copper size does not yield significant heat dissipation benefits.

Place the input capacitor as close as possible to the VIN and GND pins. Place the output capacitor as close as possible to the VOUT and GND pins. Use of 0402 size or 0603 size capacitors and resistors achieves the smallest possible footprint solution on boards where area is limited.

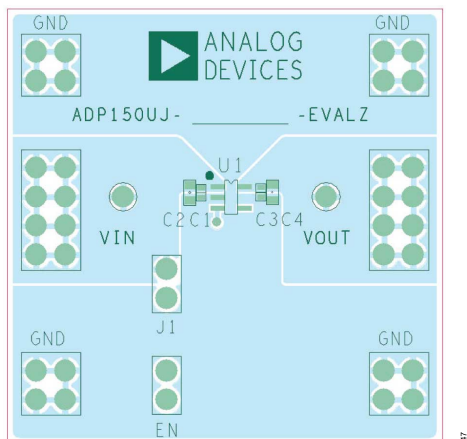


Figure 47. Example TSOT PCB Layout

OUTLINE DIMENSIONS

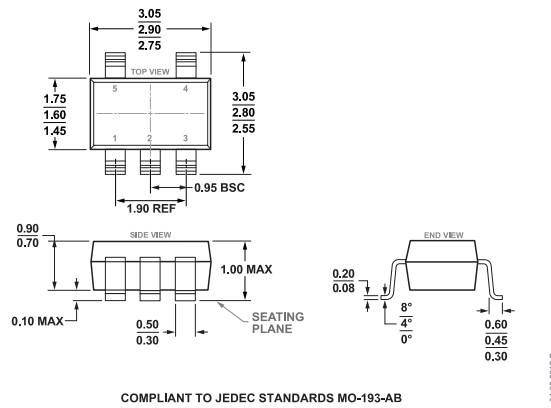


Figure 49. 5-Lead Thin Small Outline Transistor Package [TSOT] (UJ-5)
Dimensions shown in millimeters

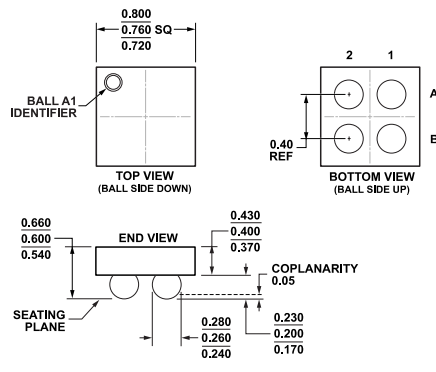


Figure 50. 4-Ball Wafer Level Chip Scale Package [WLCSP] (CB-4-3)
Dimensions shown in millimeters

Updated: November 11, 2022

ORDERING GUIDE

Table 9. Ordering Guide

Model ^{1,2}	Temperature Range	Package Description	Packing Quantity	Package Option	Marking Code
ADP150ACBZ-1.8-R7	-40°C to +125°C	4-Ball WLCSP (0.8mm x 0.8mm)	Reel, 3000	CB-4-3	36
ADP150ACBZ-2.5-R7	-40°C to +125°C	4-Ball WLCSP (0.8mm x 0.8mm)	Reel, 3000	CB-4-3	3V
ADP150ACBZ-2.6-R7	-40°C to +125°C	4-Ball WLCSP (0.8mm x 0.8mm)	Reel, 3000	CB-4-3	63
ADP150ACBZ-2.75R7	-40°C to +125°C	4-Ball WLCSP (0.8mm x 0.8mm)	Reel, 3000	CB-4-3	3X
ADP150ACBZ-2.85R7	-40°C to +125°C	4-Ball WLCSP (0.8mm x 0.8mm)	Reel, 3000	CB-4-3	3Y
ADP150ACBZ-2.8-R7	-40°C to +125°C	4-Ball WLCSP (0.8mm x 0.8mm)	Reel, 3000	CB-4-3	46
ADP150ACBZ-3.0-R7	-40°C to +125°C	4-Ball WLCSP (0.8mm x 0.8mm)	Reel, 3000	CB-4-3	47
ADP150ACBZ-3.3-R7	-40°C to +125°C	4-Ball WLCSP (0.8mm x 0.8mm)	Reel, 3000	CB-4-3	48
ADP150AUJZ-1.8-R7	-40°C to +125°C	5-Lead TSOT	Reel, 3000	UJ-5	LDS
ADP150AUJZ-2.0-R7	-40°C to +125°C	5-Lead TSOT	Reel, 3000	UJ-5	LT4
ADP150AUJZ-2.5-R7	-40°C to +125°C	5-Lead TSOT	Reel, 3000	UJ-5	LDZ
ADP150AUJZ-2.65-R7	-40°C to +125°C	5-Lead TSOT	Reel, 3000	UJ-5	LPE
ADP150AUJZ-2.8-R7	-40°C to +125°C	5-Lead TSOT	Reel, 3000	UJ-5	LE3
ADP150AUJZ-3.0-R7	-40°C to +125°C	5-Lead TSOT	Reel, 3000	UJ-5	LE2

OUTLINE DIMENSIONS

Table 9. Ordering Guide (Continued)

Model ^{1,2}	Temperature Range	Package Description	Packing Quantity	Package Option	Marking Code
ADP150AUJZ-3.3-R7	-40°C to +125°C	5-Lead TSOT	Reel, 3000	UJ-5	LEJ
ADP150WACBZ-1.8-R7	-40°C to +125°C	4-Ball WLCSP (0.8mm x 0.8mm)	Reel, 3000	CB-4-3	EY
ADP150WACBZ-2.5-R7	-40°C to +125°C	4-Ball WLCSP (0.8mm x 0.8mm)	Reel, 3000	CB-4-3	EZ
ADP150WACBZ-2.6-R7	-40°C to +125°C	4-Ball WLCSP (0.8mm x 0.8mm)	Reel, 3000	CB-4-3	F0
ADP150WACBZ-2.75-R7	-40°C to +125°C	4-Ball WLCSP (0.8mm x 0.8mm)	Reel, 3000	CB-4-3	F1
ADP150WACBZ-2.85-R7	-40°C to +125°C	4-Ball WLCSP (0.8mm x 0.8mm)	Reel, 3000	CB-4-3	F3
ADP150WACBZ-2.8-R7	-40°C to +125°C	4-Ball WLCSP (0.8mm x 0.8mm)	Reel, 3000	CB-4-3	F2
ADP150WACBZ-3.0-R7	-40°C to +125°C	4-Ball WLCSP (0.8mm x 0.8mm)	Reel, 3000	CB-4-3	FV
ADP150WACBZ-3.3-R7	-40°C to +125°C	4-Ball WLCSP (0.8mm x 0.8mm)	Reel, 3000	CB-4-3	FW
ADP150WAUJZ-1.8-R7	-40°C to +125°C	5-Lead TSOT	Reel, 3000	UJ-5	LXA
ADP150WAUJZ-2.0-R7	-40°C to +125°C	5-Lead TSOT	Reel, 3000	UJ-5	LX8
ADP150WAUJZ-3.0-R7	-40°C to +125°C	5-Lead TSOT	Reel, 3000	UJ-5	LXB
ADP150WAUJZ-3.3-R7	-40°C to +125°C	5-Lead TSOT	Reel, 3000	UJ-5	LXD

¹ Z = RoHS Compliant Part.

² W = Qualified for Automotive Applications.

OUTPUT VOLTAGE OPTIONS

Table 10. Output Voltage Options

Model ^{1,2,3}	Output Voltage (V)
ADP150ACBZ-1.8-R7, ADP150WACBZ-1.8-R7, ADP150AUJZ-1.8-R7, ADP150WAUJZ-1.8-R7	1.8
ADP150AUJZ-2.0-R7, ADP150WAUJZ-2.0-R7	2.0
ADP150ACBZ-2.5-R7, ADP150WACBZ-2.5-R7, ADP150AUJZ-2.5-R7	2.5
ADP150ACBZ-2.6-R7, ADP150WACBZ-2.6-R7	2.6
ADP150AUJZ-2.65-R7	2.65
ADP150ACBZ-2.75R7, ADP150WACBZ-2.75-R7	2.75
ADP150ACBZ-2.8-R7, ADP150WACBZ-2.8-R7, ADP150AUJZ-2.8-R7	2.8
ADP150ACBZ-2.85R7, ADP150WACBZ-2.85-R7	2.85
ADP150ACBZ-3.0-R7, ADP150WACBZ-3.0-R7, ADP150AUJZ-3.0-R7, ADP150WAUJZ-3.0-R7	3.0
ADP150ACBZ-3.3-R7, ADP150WACBZ-3.3-R7, ADP150AUJZ-3.3-R7, ADP150WAUJZ-3.3-R7	3.3

¹ Z = RoHS Compliant Part.

² W = Qualified for Automotive Applications.

³ Up to 14 fixed output voltage options from 1.8 V to 3.3 V are available. For additional voltage options, contact your local Analog Devices, Inc., sales or distribution representative.

EVALUATION BOARDS

Table 11. Evaluation Boards

Model ¹	Description
ADP150CB-3.3-EVALZ	Evaluation Board with WLCSP Package
ADP150UJZ-REDYKIT	Evaluation Board
SCP-ADP150-EVALZ	Signal Chain Power (SCP) Evaluation Board

¹ Z = RoHS Compliant Part.

AUTOMOTIVE PRODUCTS


The ADP150W models are available with controlled manufacturing to support the quality and reliability requirements of automotive applications. Note that these automotive models may have specifications that differ from the commercial models; therefore, designers should review the

OUTLINE DIMENSIONS

[Specifications](#) section of this data sheet carefully. Only the automotive grade products shown are available for use in automotive applications. Contact your local Analog Devices account representative for specific product ordering information and to obtain the specific Automotive Reliability reports for these models.

Looking for pricing, stock, or lifecycle information?

Click below to explore more details on WIN SOURCE:

 [View ADP150AUJZ-3.3-R7 on WIN SOURCE](#)

 [Analog Devices Inc. Information](#)

Optimize Your Supply Chain with WIN SOURCE Solutions

-  Global Sourcing Solution
-  Obsolete Management
-  Cost Control Management
-  Shortage Management
-  Alternative Solution
-  Excess Inventory Management