



## MM74C914 Hex Schmitt Trigger with Extended Input Voltage

### General Description

The MM74C914 is a monolithic CMOS Hex Schmitt trigger with special input protection scheme. This scheme allows the input voltage levels to exceed  $V_{CC}$  or ground by at least 10V ( $V_{CC} - 25V$  to  $GND + 25V$ ), and is valuable for applications involving voltage level shifting or mismatched power supplies.

The positive and negative-going threshold voltages,  $V_{T+}$  and  $V_{T-}$ , show low variation with respect to temperature

(typ  $0.0005V/^{\circ}C$  at  $V_{CC} = 10V$ ). And the hysteresis,  $V_{T+} - V_{T-} \geq 0.2 V_{CC}$  is guaranteed.

### Features

- Hysteresis:  $0.45 V_{CC}$  (typ.)  $0.2 V_{CC}$  guaranteed
- Special input protection: Extended Input Voltage Range
- Wide supply voltage range: 3V to 15V
- High noise immunity:  $0.7 V_{CC}$  (typ.)
- Low power TTL compatibility: Fan out of 2 driving 74L

### Ordering Code:

Order Number	Package Number	Package Description
MM74C914M	M14A	14-Lead Small Outline Integrated Circuit (SOIC), JEDEC MS-120, 0.150" Narrow
MM74C914N	N14A	14-Lead Plastic Dual-In-Line Package (PDIP), JEDEC MS-001, 0.300" Wide

Device also available in Tape and Reel. Specify by appending suffix letter "X" to the ordering code.

### Connection Diagrams

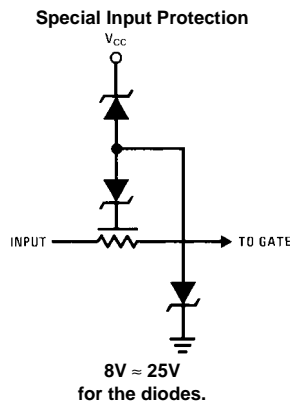
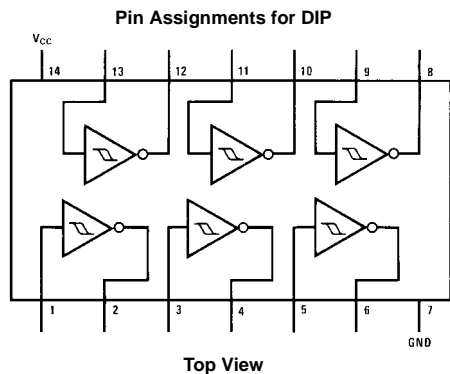

Absolute Maximum Ratings (Note 1)		Operating $V_{CC}$ Range	3V to 15V
Voltage at any Input Pin	$V_{CC} - 25V$ to GND + 25V	Absolute Maximum ( $V_{CC}$ )	18V
Voltage at any other Pin	-0.3V to $V_{CC} + 0.3V$	Lead Temperature ( $T_L$ )	300°C
Operating Temperature Range ( $T_A$ )	-40°C to +85°C	(Soldering, 10 seconds)	
Storage Temperature Range ( $T_S$ )	-65°C to +150°C		
Power Dissipation			
Dual-In-Line	700 mW		
Small Outline	500mW		

**Note 1:** "Absolute Maximum Ratings" are those values beyond which the safety of the device cannot be guaranteed. Except for "Operating Temperature Range", they are not meant to imply that the devices should be operated at these limits. The Electrical Characteristics tables provide conditions for actual device operation.

## DC Electrical Characteristics

Min/Max limits apply across temperature range unless otherwise noted

Symbol	Parameter	Conditions	Min	Typ	Max	Units
<b>CMOS TO CMOS</b>						
$V_{T+}$	Positive Going Threshold Voltage	$V_{CC} = 5V$ $V_{CC} = 10V$ $V_{CC} = 15V$	3.0 6.0 9.0	3.6 6.8 10	4.3 8.6 12.9	V
$V_{T-}$	Negative Going Threshold Voltage	$V_{CC} = 5V$ $V_{CC} = 10V$ $V_{CC} = 15V$	0.7 1.4 2.1	1.4 3.2 5	2.0 4.0 6.0	V
$V_{T+} - V_{T-}$	Hysteresis	$V_{CC} = 5V$ $V_{CC} = 10V$ $V_{CC} = 15V$	1.0 2.0 3.0	2.2 3.6 5	3.6 7.2 10.8	V
$V_{OUT(1)}$	Logical "1" Output Voltage	$V_{CC} = 5V, I_O = -10 \mu A$ $V_{CC} = 10V, I_O = -10 \mu A$	4.5 9.0			V
$V_{OUT(0)}$	Logical "0" Output Voltage	$V_{CC} = 5V, I_O = +10 \mu A$ $V_{CC} = 10V, I_O = +10 \mu A$			0.5 1.0	V
$I_{IN(1)}$	Logical "1" Input Current	$V_{CC} = 15V, V_{IN} = 25V$		0.005	5.0	$\mu A$
$I_{IN(0)}$	Logical "0" Input Current	$V_{CC} = 15V, V_{IN} = -10V$	-100	-0.005		$\mu A$
$I_{CC}$	Supply Current	$V_{CC} = 15V, V_{IN} = -10V/25V$ $V_{CC} = 5V, V_{IN} = -2.5V$ (Note 2) $V_{CC} = 10V, V_{IN} = 5V$ (Note 2) $V_{CC} = 15V, V_{IN} = 7.5V$ (Note 2)		0.05 20 200 600	300	$\mu A$
<b>CMOS/LPTTL INTERFACE</b>						
$V_{IN(1)}$	Logical "1" Input Voltage	$V_{CC} = 5V$	4.3			V
$V_{IN(0)}$	Logical "0" Input Voltage	$V_{CC} = 5V$			0.7	V
$V_{OUT(1)}$	Logical "1" Output Voltage	$V_{CC} = 4.75V, I_O = -360 \mu A$	2.4			V
$V_{OUT(0)}$	Logical "0" Output Voltage	$V_{CC} = 4.75V, I_O = 360 \mu A$			0.4	V
<b>OUTPUT DRIVE (See Family Characteristics Data Sheet) (Short Circuit Current)</b>						
$I_{SOURCE}$	Output Source Current (P-Channel)	$V_{CC} = 5V, V_{OUT} = 0V, T_A = 25^\circ C$	-1.75	-3.3		mA
$I_{SOURCE}$	Output Source Current (P-Channel)	$V_{CC} = 10V, V_{OUT} = 0V, T_A = 25^\circ C$	-8.0	-15		mA
$I_{SINK}$	Output Sink Current (N-Channel)	$V_{CC} = 5V, V_{OUT} = V_{CC}, T_A = 25^\circ C$	1.75	3.6		mA
$I_{SINK}$	Output Sink Current (N-Channel)	$V_{CC} = 10V, V_{OUT} = V_{CC}, T_A = 25^\circ C$	8.0	16		mA

**Note 2:** Only one input is at  $\frac{1}{2} V_{CC}$ , the others are either at  $V_{CC}$  or GND.

### AC Electrical Characteristics (Note 3)

$T_A = 25^\circ\text{C}$ ,  $C_L = 50\text{ pF}$ , unless otherwise specified

Symbol	Parameter	Conditions	Min	Typ	Max	Units
$t_{PHL}$	Propagation Delay from Input to Output	$V_{CC} = 5\text{V}$		220	400	ns
$t_{PLH}$		$V_{CC} = 10\text{V}$		80	200	ns
$C_{IN}$	Input Capacitance	Any Input (Note 4)		5		pF
$C_{PD}$	Power Dissipation Capacitance	Per Gate (Note 5)		20		pF

**Note 3:** AC Parameters are guaranteed by DC correlated testing.

**Note 4:** Capacitance is guaranteed by periodic testing.

**Note 5:**  $C_{PD}$  determines the no load AC power consumption of any CMOS device. For complete explanation see Family Characteristics Application Note, AN-90.

### Typical Performance Characteristics

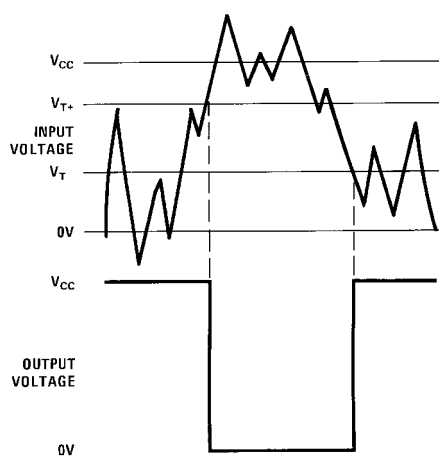
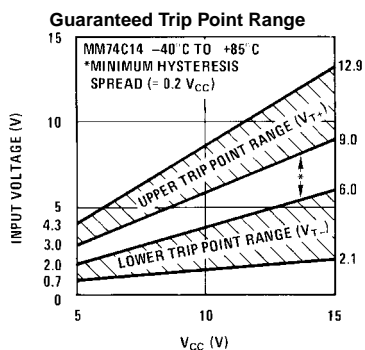
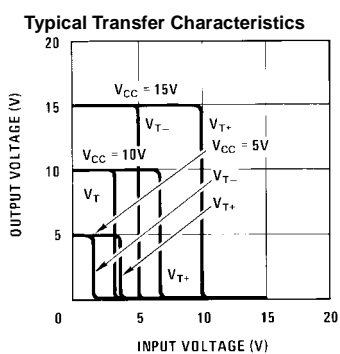

### Typical Application

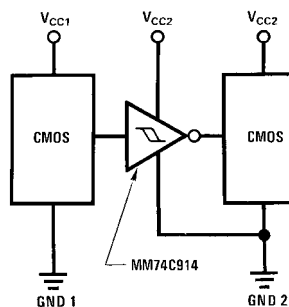

**Note:**  $V_{CC1} = V_{CC2}$

$GND1 = GND2$

**Physical Dimensions** inches (millimeters) unless otherwise noted

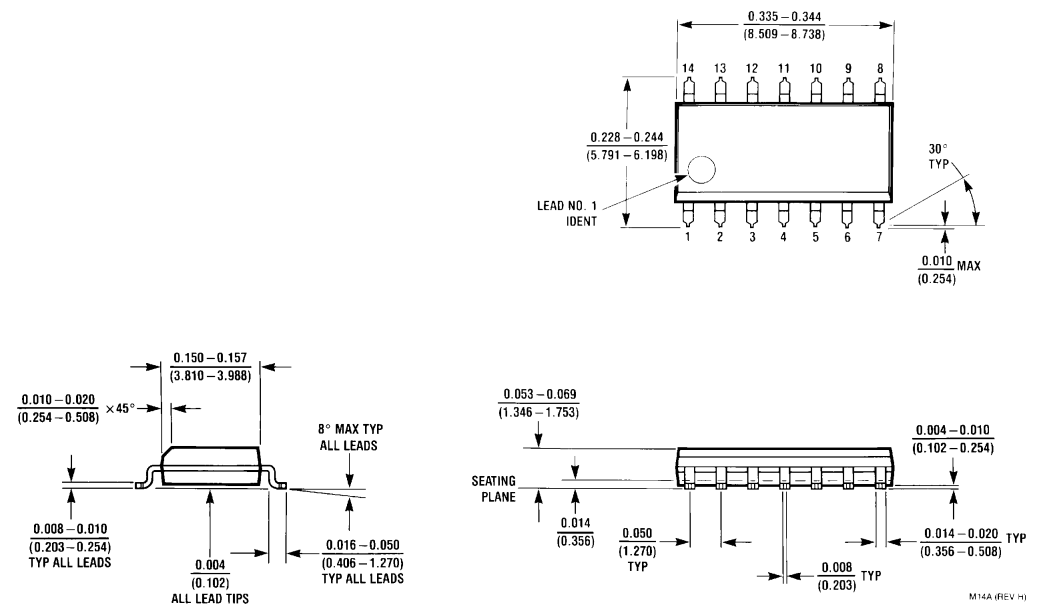

**14-Lead Small Outline Integrated Circuit (SOIC), JEDEC MS-120, 0.150" Narrow  
Package Number M14A**

**Physical Dimensions** inches (millimeters) unless otherwise noted (Continued)

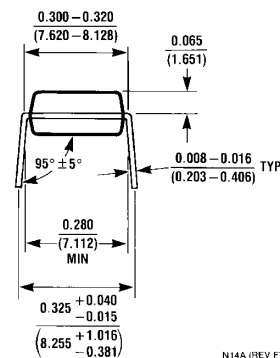
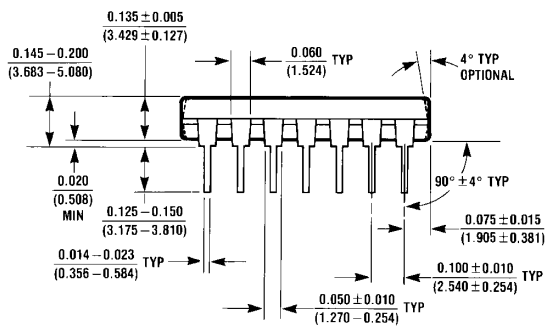
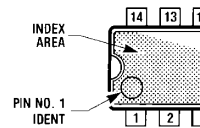
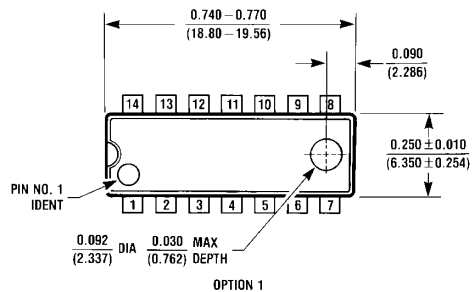

**14-Lead Plastic Dual-In-Line Package (PDIP), JEDEC MS-001, 0.300" Wide  
Package Number N14A**

**LIFE SUPPORT POLICY**

FAIRCHILD'S PRODUCTS ARE NOT AUTHORIZED FOR USE AS CRITICAL COMPONENTS IN LIFE SUPPORT DEVICES OR SYSTEMS WITHOUT THE EXPRESS WRITTEN APPROVAL OF THE PRESIDENT OF FAIRCHILD SEMICONDUCTOR CORPORATION. As used herein:

1. Life support devices or systems are devices or systems which, (a) are intended for surgical implant into the body, or (b) support or sustain life, and (c) whose failure to perform when properly used in accordance with instructions for use provided in the labeling, can be reasonably expected to result in a significant injury to the user.
2. A critical component in any component of a life support device or system whose failure to perform can be reasonably expected to cause the failure of the life support device or system, or to affect its safety or effectiveness.

[www.fairchildsemi.com](http://www.fairchildsemi.com)

## Looking for pricing, stock, or lifecycle information?

Click below to explore more details on WIN SOURCE:

- ⊖ [View MM74C914M on WIN SOURCE](#)
- ⊖ [Fairchild/ON Semiconductor Information](#)

## Optimize Your Supply Chain with WIN SOURCE Solutions

- ✓ Global Sourcing Solution
- ✓ Obsolete Management
- ✓ Cost Control Management
- ✓ Shortage Management
- ✓ Alternative Solution
- ✓ Excess Inventory Management