



THE DATASHEET OF
SI4916DY-T1-E3



Dual N-Channel 30-V (D-S) MOSFET with Schottky Diode

PRODUCT SUMMARY				
	V _{DS} (V)	R _{DS(on)} (Ω)	I _D (A) ^a	Q _g (Typ.)
Channel-1	30	0.018 at V _{GS} = 10 V	10	6.6
		0.023 at V _{GS} = 4.5 V	8.5	
Channel-2		0.018 at V _{GS} = 10 V	10.5	8.9
		0.022 at V _{GS} = 4.5 V	9.3	

SCHOTTKY PRODUCT SUMMARY		
V _{DS} (V)	V _{SD} (V) Diode Forward Voltage	I _F (A)
30	0.50 V at 1.0 A	2.0

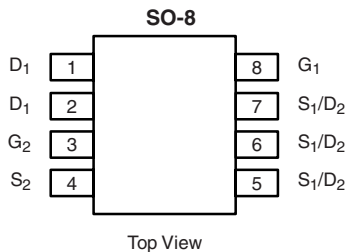

Ordering Information: Si4916DY-T1-E3 (Lead (Pb)-free)
Si4916DY-T1-GE3 (Lead (Pb)-free and Halogen-free)

FEATURES

- Halogen-free According to IEC 61249-2-21 Available
- LITTLE FOOT[®] Plus Integrated Schottky
- 100 % R_g Tested

APPLICATIONS

- DC/DC Converters
- Notebook



RoHS
COMPLIANT
HALOGEN
FREE
Available

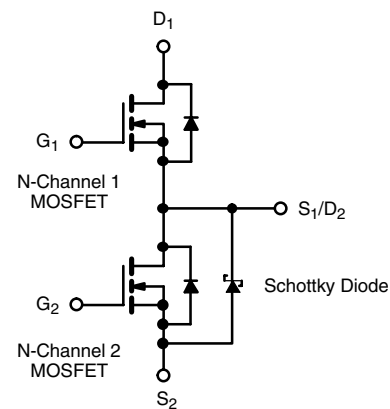

ABSOLUTE MAXIMUM RATINGS T _A = 25 °C, unless otherwise noted					
Parameter	Symbol	Channel-1	Channel-2	Unit	
Drain-Source Voltage	V _{DS}	30		V	
Gate-Source Voltage	V _{GS}	20			
Continuous Drain Current (T _J = 150 °C) ^{a, b}	I _D	T _C = 25 °C	10	10.5	A
		T _C = 70 °C	8	8.3	
		T _A = 25 °C	7.5 ^{a, b, c}	7.8 ^{a, b, c}	
		T _A = 70 °C	6 ^{a, b, c}	6.3 ^{a, b, c}	
Pulsed Drain Current (10 μs Pulse Width)	I _{DM}	40	40	A	
Continuous Source-Drain Diode Current	I _S	T _C = 25 °C	3		3.2
		T _A = 25 °C	1.7 ^{a, b, c}	1.8 ^{a, b, c}	
PulseD Source-Drain Current	I _{SM}	40	40	mJ	
Single-Pulse Avalanche Current	I _{AS}	15			
Single-Pulse Avalanche Energy	E _{AS}	11.2			
Maximum Power Dissipation ^{a, b}	P _D	T _C = 25 °C	3.3	3.5	W
		T _C = 70 °C	2.1	2.2	
		T _A = 25 °C	1.9 ^{a, b, c}	2.0 ^{a, b, c}	
		T _A = 70 °C	1.2 ^{a, b, c}	1.3 ^{a, b, c}	
Operating Junction and Storage Temperature Range	T _J , T _{stg}	- 55 to 150		°C	

Notes:

a. Based on T_C = 25 °C.

b. Surface Mounted on 1" x 1" FR4 board.

c. t = 10 s.

THERMAL RESISTANCE RATINGS

Parameter		Symbol	Channel-1		Channel-2		Unit
			Typ.	Max.	Typ.	Max.	
Maximum Junction-to-Ambient ^a	$t \leq 10$ s	R_{thJA}	54	65	47	60	°C/W
Maximum Junction-to-Foot (Drain)	Steady State	R_{thJF}	32	38	30	35	

Notes:

a. Surface Mounted on 1" x 1" FR4 board.

b. Maximum under Steady State conditions is 112 °C/W for Channel 1 and 107 °C/W for Channel 2.

MOSFET SPECIFICATIONS $T_J = 25$ °C, unless otherwise noted

Parameter	Symbol	Test Conditions	Min.	Typ. ^a	Max.	Unit	
Static							
Drain-Source Breakdown Voltage	V_{DS}	$V_{GS} = 0$ V, $I_D = 250$ μ A	Ch-1 30 Ch-2 30			V	
V_{DS} Temperature Coefficient	$\Delta V_{DS}/T_J$	$I_D = 250$ μ A	Ch-1 Ch-2	24 25		mV/°C	
$V_{GS(th)}$ Temperature Coefficient	$\Delta V_{GS(th)}/T_J$		Ch-1 Ch-2	-6 -6		V	
Gate Threshold Voltage	$V_{GS(th)}$	$V_{DS} = V_{GS}$, $I_D = 250$ μ A	Ch-1 Ch-2	1.5 1.5	3.0 2.7	V	
Gate-Body Leakage	I_{GSS}	$V_{DS} = 0$ V, $V_{GS} = 20$ V	Ch-1 Ch-2		100 100	nA	
Zero Gate Voltage Drain Current	I_{DSS}	$V_{DS} = 30$ V, $V_{GS} = 0$ V	Ch-1 Ch-2		1 100	μ A	
		$V_{DS} = 30$ V, $V_{GS} = 0$ V, $T_J = 85$ °C	Ch-1 Ch-2		15 2000		
On-State Drain Current ^b	$I_{D(on)}$	$V_{DS} = 5$ V, $V_{GS} = 10$ V	Ch-1 Ch-2	20 20		A	
Drain-Source On-State Resistance ^b	$R_{DS(on)}$	$V_{GS} = 10$ V, $I_D = 10$ A	Ch-1		0.0145	0.018	Ω
		$V_{GS} = 10$ V, $I_D = 10.5$ A	Ch-2		0.015	0.018	
		$V_{GS} = 4.5$ V, $I_D = 8.5$ A	Ch-1		0.019	0.023	
		$V_{GS} = 4.5$ V, $I_D = 9.3$ A	Ch-2		0.018	0.022	
Forward Transconductance ^b	g_{fs}	$V_{DS} = 15$ V, $I_D = 10$ A	Ch-1		30	S	
		$V_{DS} = 15$ V, $I_D = 10.5$ A	Ch-2		35		
Diode Forward Voltage ^b	V_{SD}	$I_S = 1.7$ A, $V_{GS} = 0$ V	Ch-1		0.75	1.1	V
		$I_S = 1$ A, $V_{GS} = 0$ V	Ch-2		0.47	0.5	
Dynamic^a							
Total Gate Charge	Q_g	Channel-1 $V_{DS} = 15$ V, $V_{GS} = 4.5$ V, $I_D = 10$ A	Ch-1 Ch-2		6.6 8.9	10 14	nC
Gate-Source Charge	Q_{gs}		Ch-1 Ch-2		2.9 3.4		
Gate-Drain Charge	Q_{gd}	Channel-2 $V_{DS} = 15$ V, $V_{GS} = 4.5$ V, $I_D = -10.5$ A	Ch-1 Ch-2		2.3 2.4		
			Ch-1 Ch-2		0.5 0.5	1.9 2.3	



MOSFET SPECIFICATIONS $T_J = 25\text{ }^\circ\text{C}$, unless otherwise noted						
Parameter	Symbol	Test Conditions	Min.	Typ. ^a	Max.	Unit
Dynamic^a						
Turn-On Delay Time	$t_{d(on)}$	Channel-1 $V_{DD} = 15\text{ V}$, $R_L = 15\ \Omega$ $I_D \cong 1\text{ A}$, $V_{GEN} = 10\text{ V}$, $R_g = 6\ \Omega$	Ch-1	8	15	ns
			Ch-2	9	15	
Rise Time	t_r		Ch-1	11	18	
			Ch-2	13	20	
Turn-Off Delay Time	$t_{d(off)}$	Channel-2 $V_{DD} = 15\text{ V}$, $R_L = 15\ \Omega$ $I_D \cong 1\text{ A}$, $V_{GEN} = 10\text{ V}$, $R_g = 6\ \Omega$	Ch-1	21	32	
			Ch-2	27	40	
Fall Time	t_f		Ch-1	6	10	
			Ch-2	9	15	
Source-Drain Reverse Recovery Time	t_{rr}	$I_F = 1.3\text{ A}$, $dI/dt = 100\text{ A}/\mu\text{s}$ $I_F = 2.2\text{ A}$, $dI/dt = 100\ \mu\text{A}/\mu\text{s}$	Ch-1	28	40	
			Ch-2	24	35	
Body Diode Reverse Recovery Charge	Q_{rr}	$I_F = 1.3\text{ A}$, $dI/dt = 100\text{ A}/\mu\text{s}$ $I_F = 2.2\text{ A}$, $dI/dt = 100\ \mu\text{A}/\mu\text{s}$	Ch-1	17		nC
			Ch-2	12		
Reverse Recovery Fall Time	t_a	$I_F = 1.3\text{ A}$, $dI/dt = 100\text{ A}/\mu\text{s}$ $I_F = 2.2\text{ A}$, $dI/dt = 100\ \mu\text{A}/\mu\text{s}$	Ch-1	12		ns
			Ch-2	11		
Reverse Recovery Rise Time	t_b	$I_F = 1.3\text{ A}$, $dI/dt = 100\text{ A}/\mu\text{s}$ $I_F = 2.2\text{ A}$, $dI/dt = 100\ \mu\text{A}/\mu\text{s}$	Ch-1	16		
			Ch-2	13		

Notes:

- a. Guaranteed by design, not subject to production testing.
- b. Pulse test; pulse width $\leq 300\ \mu\text{s}$, duty cycle $\leq 2\%$.

SCHOTTKY SPECIFICATIONS $T_J = 25\text{ }^\circ\text{C}$, unless otherwise noted						
Parameter	Symbol	Test Conditions	Min.	Typ.	Max.	Unit
Forward Voltage Drop	V_F	$I_F = 1.0\text{ A}$		0.47	0.50	V
		$I_F = 1.0\text{ A}$, $T_J = 125\text{ }^\circ\text{C}$		0.36	0.42	
Maximum Reverse Leakage Current	I_{rm}	$V_R = 30\text{ V}$		0.004	0.100	mA
		$V_R = 30\text{ V}$, $T_J = 100\text{ }^\circ\text{C}$		0.7	10	
		$V_R = -30\text{ V}$, $T_J = 125\text{ }^\circ\text{C}$		3.0	20	
Junction Capacitance	C_T	$V_R = 10\text{ V}$		50		pF

Stresses beyond those listed under "Absolute Maximum Ratings" may cause permanent damage to the device. These are stress ratings only, and functional operation of the device at these or any other conditions beyond those indicated in the operational sections of the specifications is not implied. Exposure to absolute maximum rating conditions for extended periods may affect device reliability.

CHANNEL-1 TYPICAL CHARACTERISTICS 25 °C, unless otherwise noted

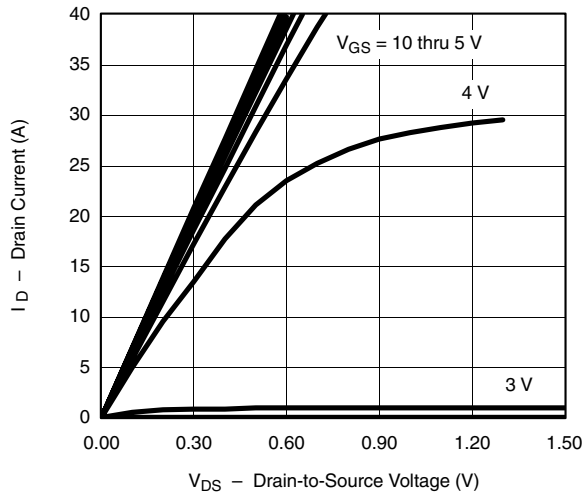

Output Characteristics

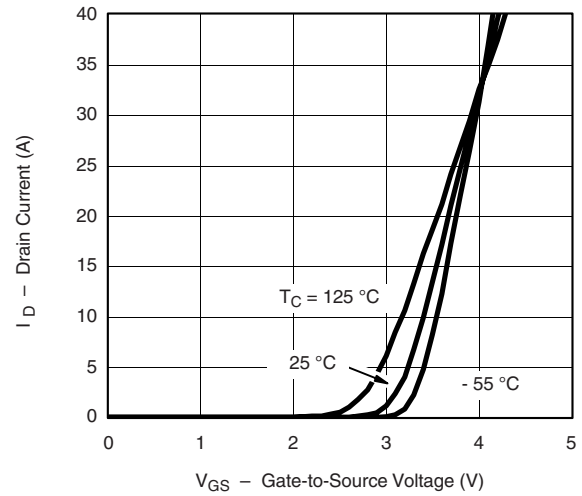

Transfer Characteristics

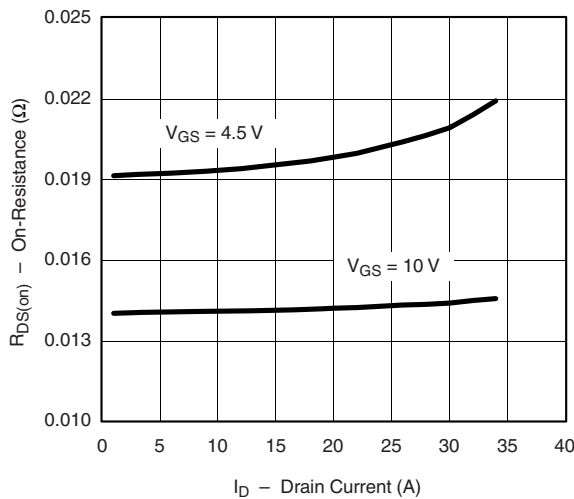

On-Resistance vs. Drain Current

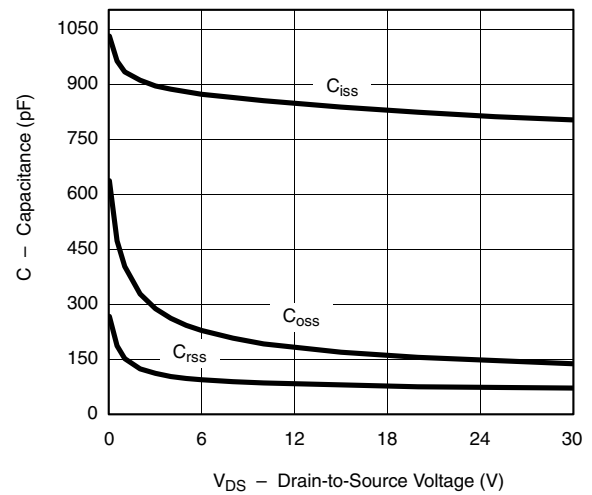

Capacitance

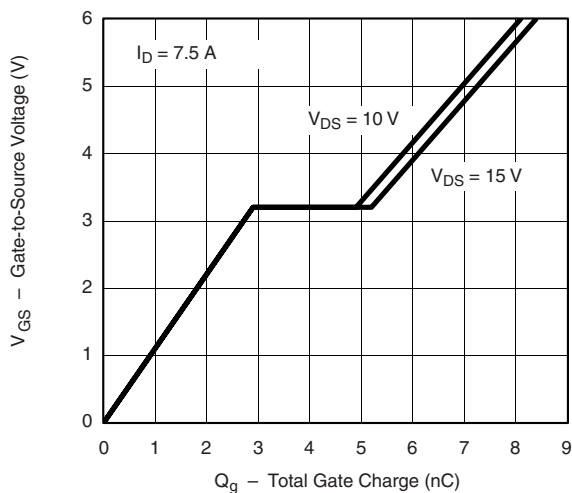

Gate Charge

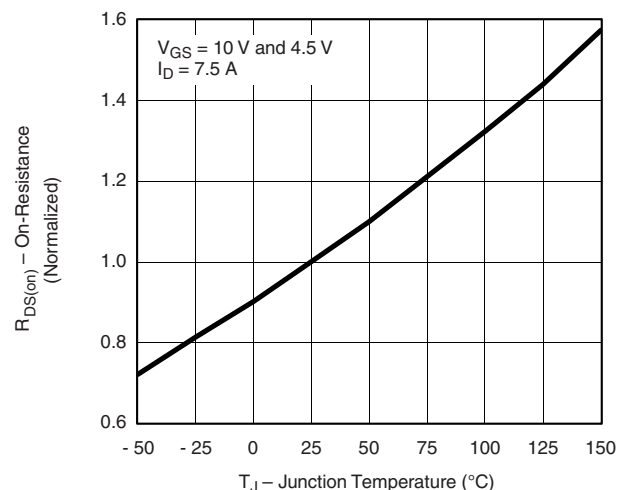

On-Resistance vs. Junction Temperature

CHANNEL-1 TYPICAL CHARACTERISTICS 25 °C, unless otherwise noted

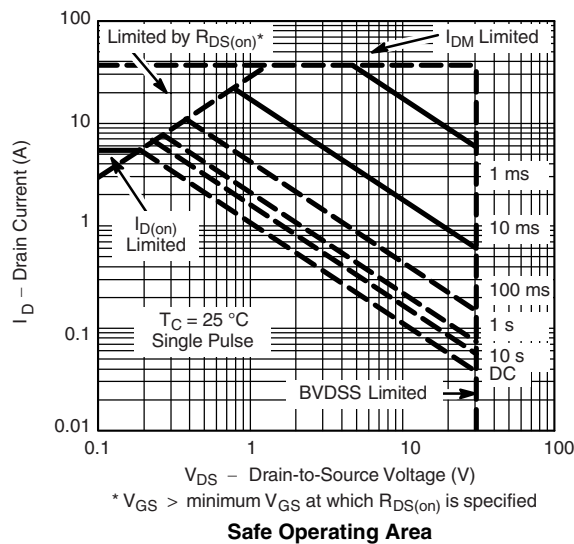
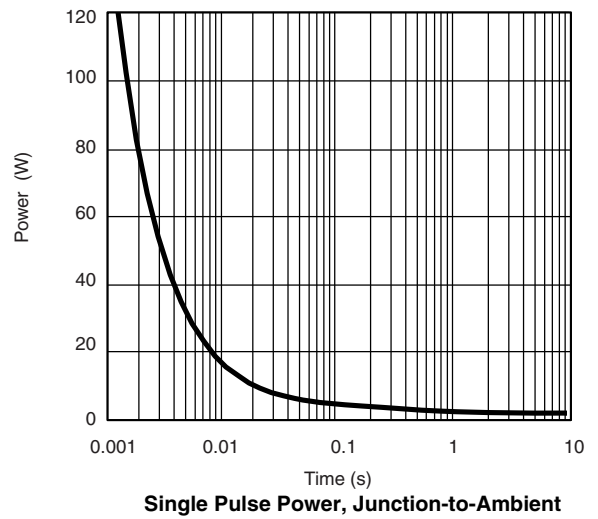
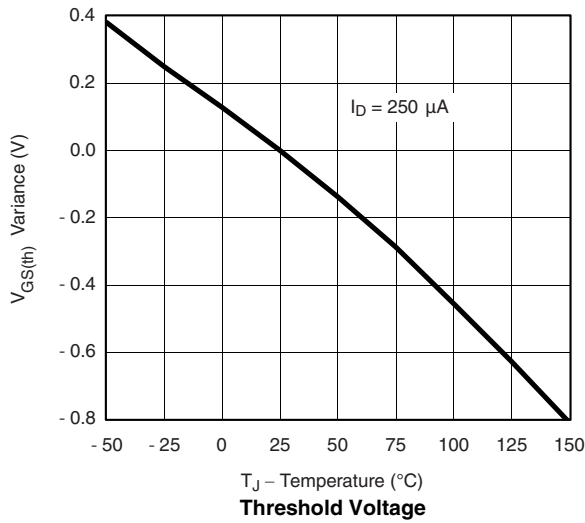
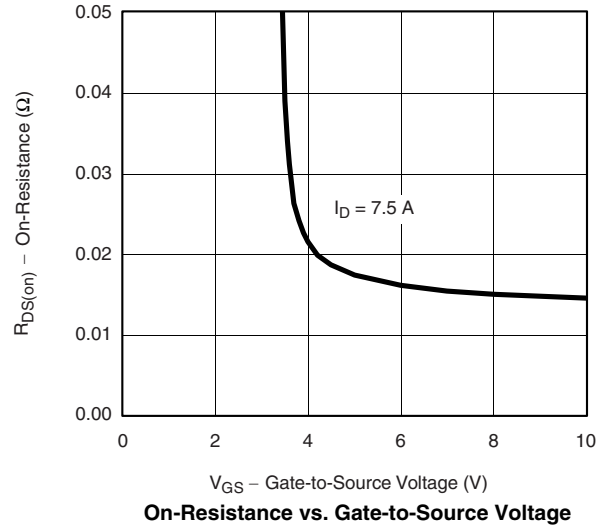
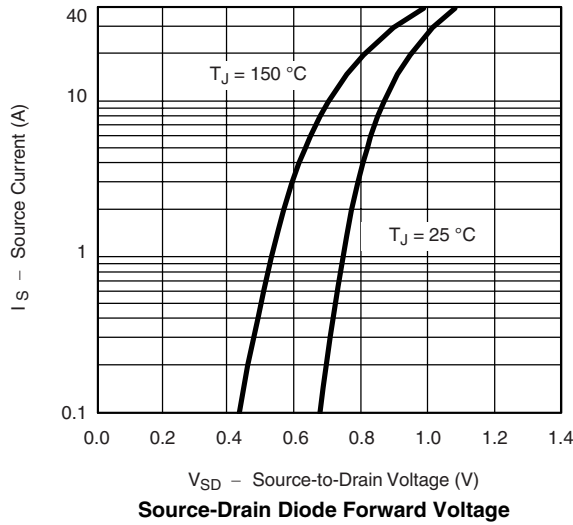

CHANNEL-1 TYPICAL CHARACTERISTICS 25 °C, unless otherwise noted

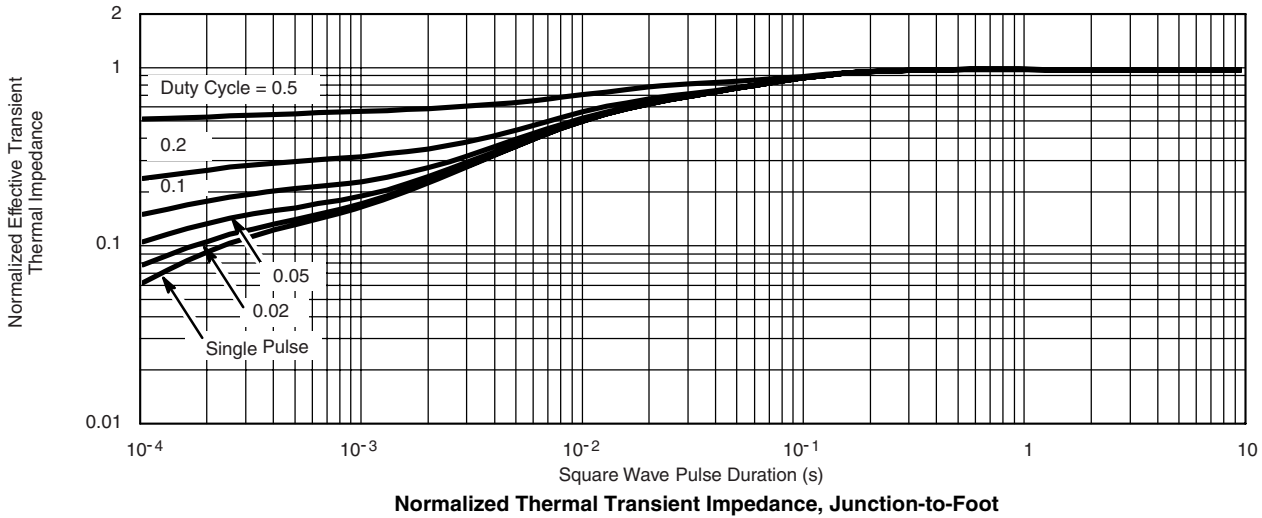
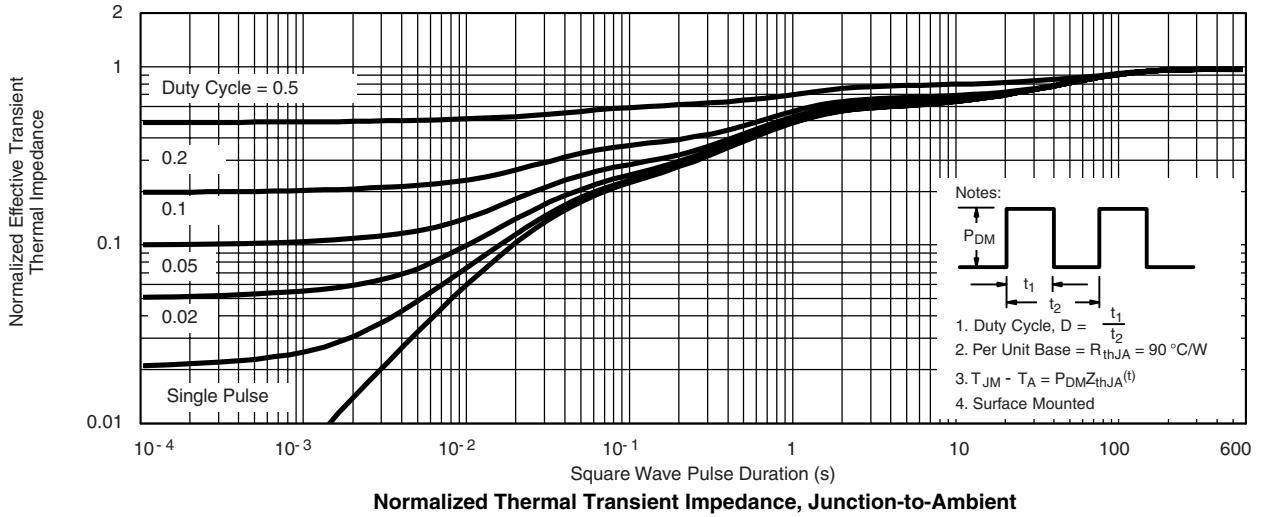

CHANNEL-2 TYPICAL CHARACTERISTICS 25 °C, unless otherwise noted

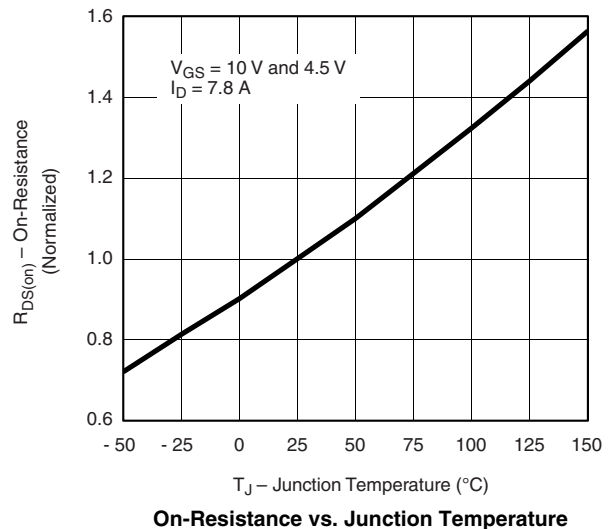
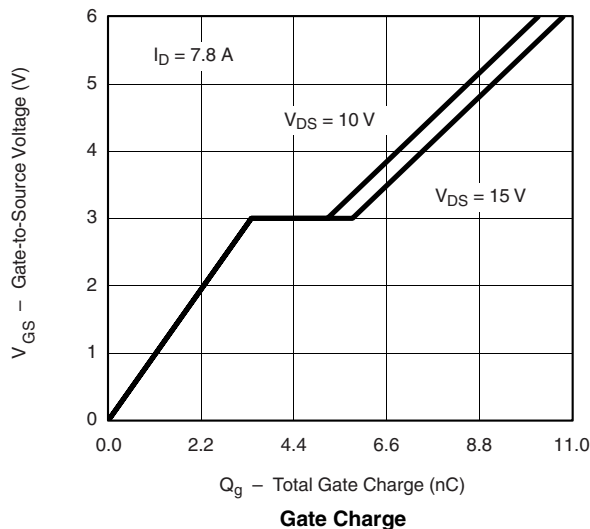
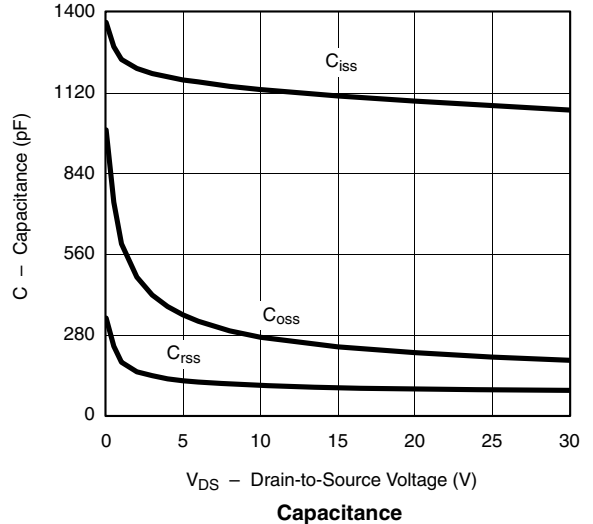
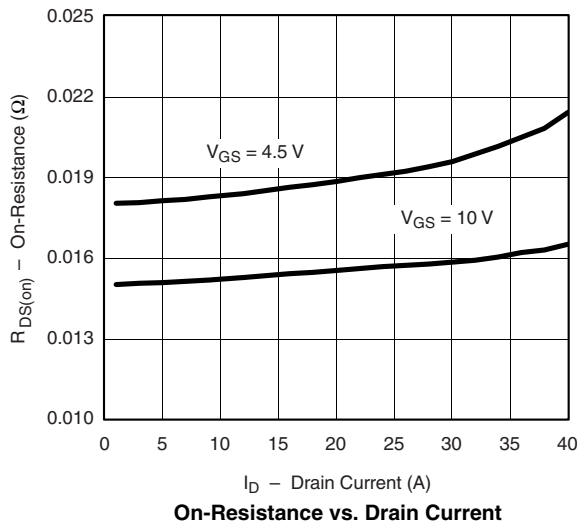
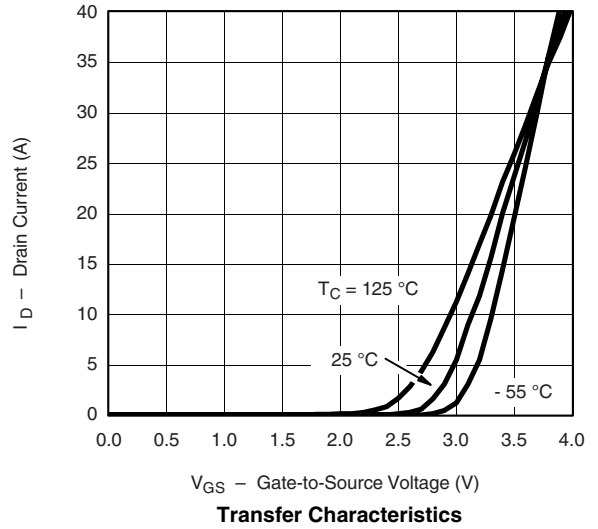
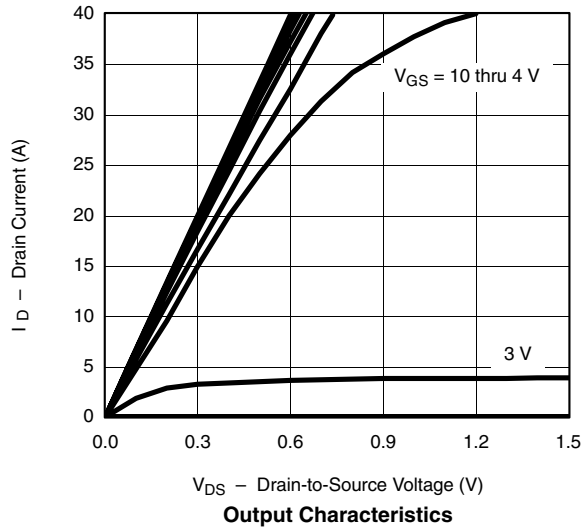

CHANNEL-2 TYPICAL CHARACTERISTICS 25 °C, unless otherwise noted

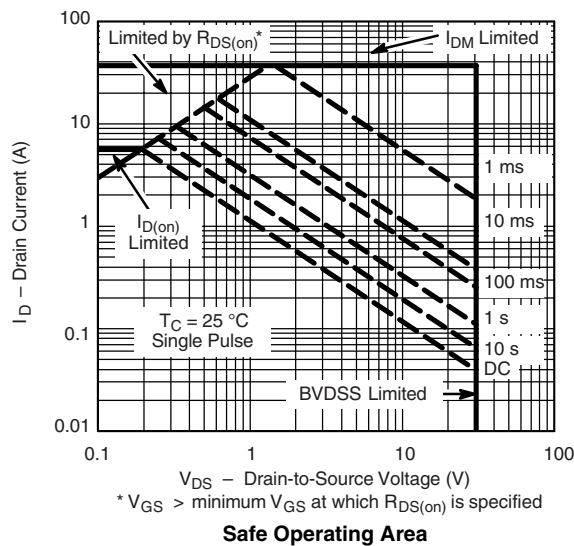
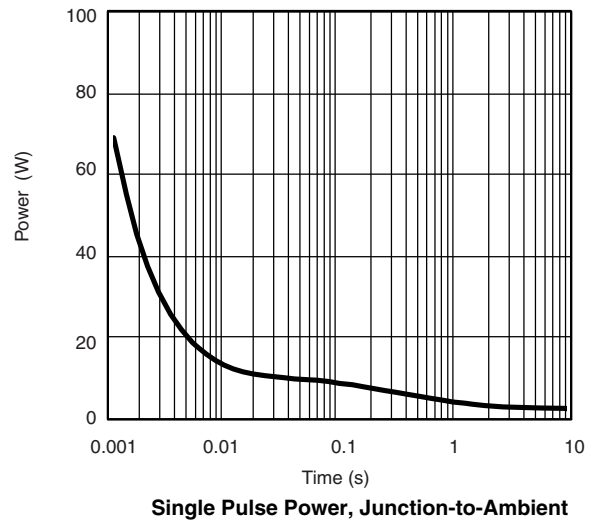
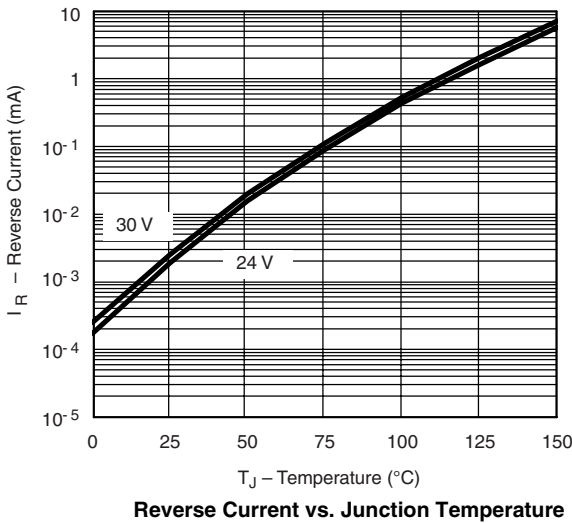
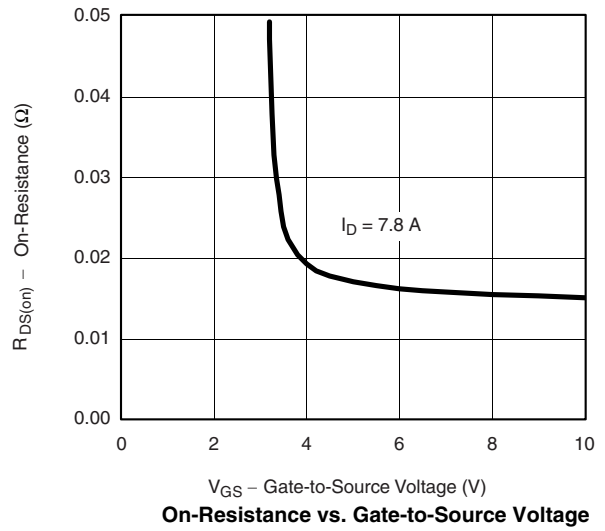
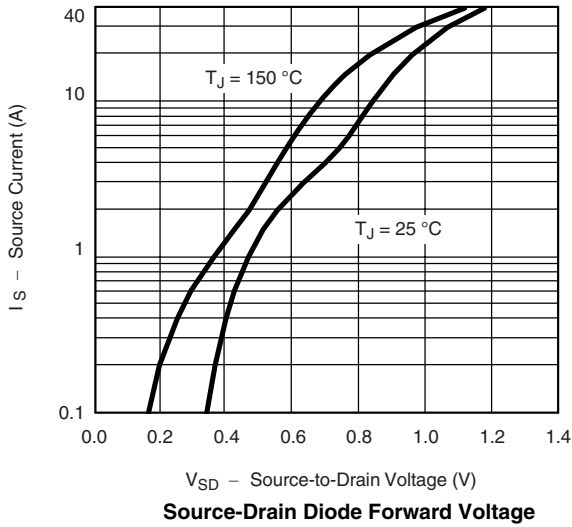

CHANNEL-2 TYPICAL CHARACTERISTICS 25 °C, unless otherwise noted

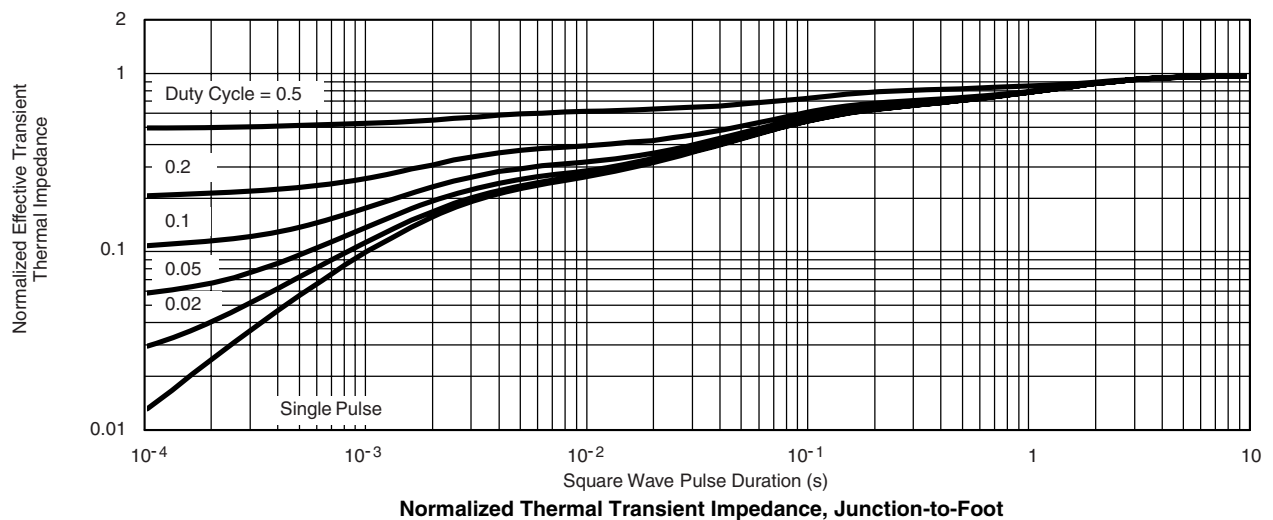
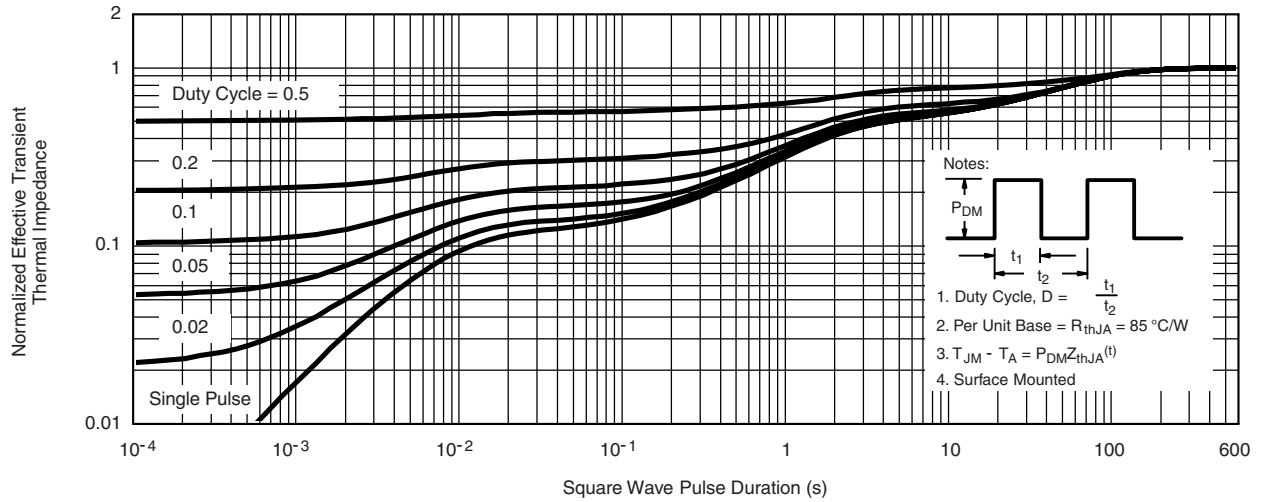

Vishay Siliconix maintains worldwide manufacturing capability. Products may be manufactured at one of several qualified locations. Reliability data for Silicon Technology and Package Reliability represent a composite of all qualified locations. For related documents such as package/tape drawings, part marking, and reliability data, see www.vishay.com/ppg?74331.

SOIC (NARROW): 8-LEAD

JEDEC Part Number: MS-012

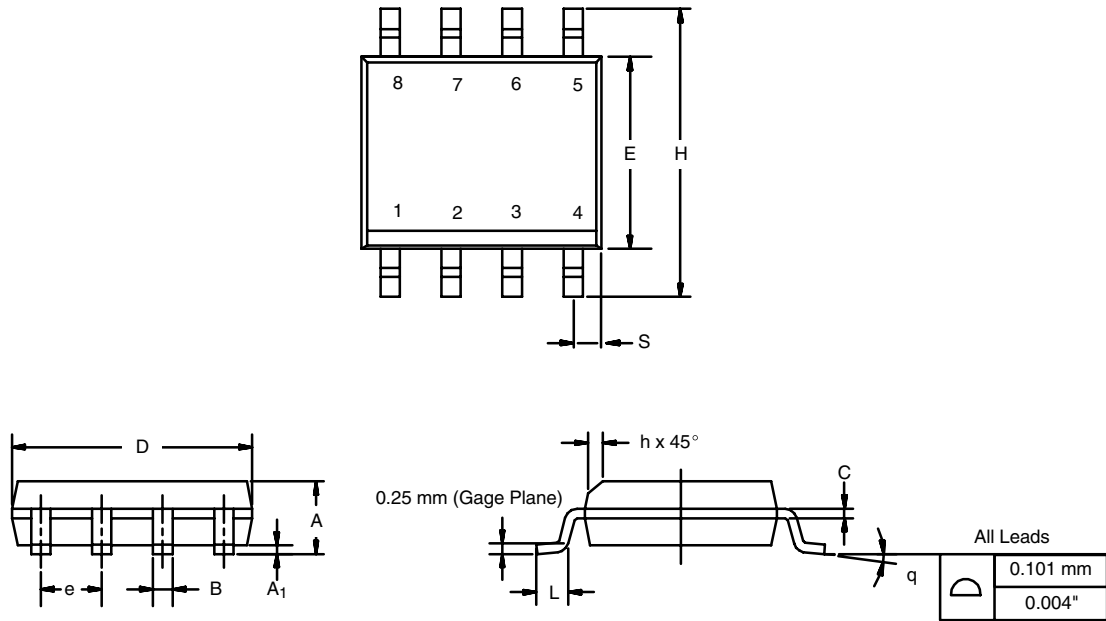

DIM	MILLIMETERS		INCHES	
	Min	Max	Min	Max
A	1.35	1.75	0.053	0.069
A ₁	0.10	0.20	0.004	0.008
B	0.35	0.51	0.014	0.020
C	0.19	0.25	0.0075	0.010
D	4.80	5.00	0.189	0.196
E	3.80	4.00	0.150	0.157
e	1.27 BSC		0.050 BSC	
H	5.80	6.20	0.228	0.244
h	0.25	0.50	0.010	0.020
L	0.50	0.93	0.020	0.037
q	0°	8°	0°	8°
S	0.44	0.64	0.018	0.026
ECN: C-06527-Rev. I, 11-Sep-06				
DWG: 5498				

RECOMMENDED MINIMUM PADS FOR SO-8

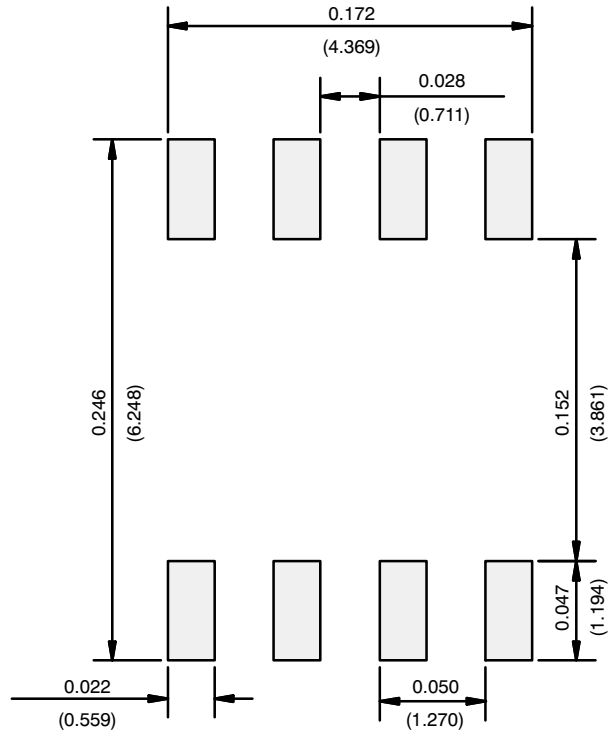

Recommended Minimum Pads
Dimensions in Inches/(mm)

[Return to Index](#)



Disclaimer

ALL PRODUCT, PRODUCT SPECIFICATIONS AND DATA ARE SUBJECT TO CHANGE WITHOUT NOTICE TO IMPROVE RELIABILITY, FUNCTION OR DESIGN OR OTHERWISE.

Vishay Intertechnology, Inc., its affiliates, agents, and employees, and all persons acting on its or their behalf (collectively, "Vishay"), disclaim any and all liability for any errors, inaccuracies or incompleteness contained in any datasheet or in any other disclosure relating to any product.

Vishay makes no warranty, representation or guarantee regarding the suitability of the products for any particular purpose or the continuing production of any product. To the maximum extent permitted by applicable law, Vishay disclaims (i) any and all liability arising out of the application or use of any product, (ii) any and all liability, including without limitation special, consequential or incidental damages, and (iii) any and all implied warranties, including warranties of fitness for particular purpose, non-infringement and merchantability.

Statements regarding the suitability of products for certain types of applications are based on Vishay's knowledge of typical requirements that are often placed on Vishay products in generic applications. Such statements are not binding statements about the suitability of products for a particular application. It is the customer's responsibility to validate that a particular product with the properties described in the product specification is suitable for use in a particular application. Parameters provided in datasheets and / or specifications may vary in different applications and performance may vary over time. All operating parameters, including typical parameters, must be validated for each customer application by the customer's technical experts. Product specifications do not expand or otherwise modify Vishay's terms and conditions of purchase, including but not limited to the warranty expressed therein.

Except as expressly indicated in writing, Vishay products are not designed for use in medical, life-saving, or life-sustaining applications or for any other application in which the failure of the Vishay product could result in personal injury or death. Customers using or selling Vishay products not expressly indicated for use in such applications do so at their own risk. Please contact authorized Vishay personnel to obtain written terms and conditions regarding products designed for such applications.

No license, express or implied, by estoppel or otherwise, to any intellectual property rights is granted by this document or by any conduct of Vishay. Product names and markings noted herein may be trademarks of their respective owners.

Looking for pricing, stock, or lifecycle information?

Click below to explore more details on WIN SOURCE:

 [View SI4916DY-T1-E3 on WIN SOURCE](#)

 [Vishay Information](#)

Optimize Your Supply Chain with WIN SOURCE Solutions

-  Global Sourcing Solution
-  Obsolete Management
-  Cost Control Management
-  Shortage Management
-  Alternative Solution
-  Excess Inventory Management