



**THE DATASHEET OF  
ADS8341EB**





# 16-Bit, 4-Channel Serial Output Sampling ANALOG-TO-DIGITAL CONVERTER

## FEATURES

- PIN FOR PIN WITH ADS7841
- SINGLE SUPPLY: 2.7V to 5V
- 4-CHANNEL SINGLE-ENDED OR 2-CHANNEL DIFFERENTIAL INPUT
- UP TO 100kHz CONVERSION RATE
- 86dB SINAD
- SERIAL INTERFACE
- SSOP-16 PACKAGE

## APPLICATIONS

- DATA ACQUISITION
- TEST AND MEASUREMENT
- INDUSTRIAL PROCESS CONTROL
- PERSONAL DIGITAL ASSISTANTS
- BATTERY-POWERED SYSTEMS

## DESCRIPTION

The ADS8341 is a 4-channel, 16-bit sampling Analog-to-Digital (A/D) converter with a synchronous serial interface. Typical power dissipation is 8mW at a 100kHz throughput rate and a +5V supply. The reference voltage ( $V_{REF}$ ) can be varied between 500mV and  $V_{CC}$ , providing a corresponding input voltage range of 0V to  $V_{REF}$ . The device includes a shutdown mode that reduces power dissipation to under 15 $\mu$ W. The ADS8341 is tested down to 2.7V operation.

Low power, high speed, and an onboard multiplexer make the ADS8341 ideal for battery-operated systems such as personal digital assistants, portable multi-channel data loggers, and measurement equipment. The serial interface also provides low-cost isolation for remote data acquisition. The ADS8341 is available in an SSOP-16 package and is ensured over the  $-40^{\circ}\text{C}$  to  $+85^{\circ}\text{C}$  temperature range.

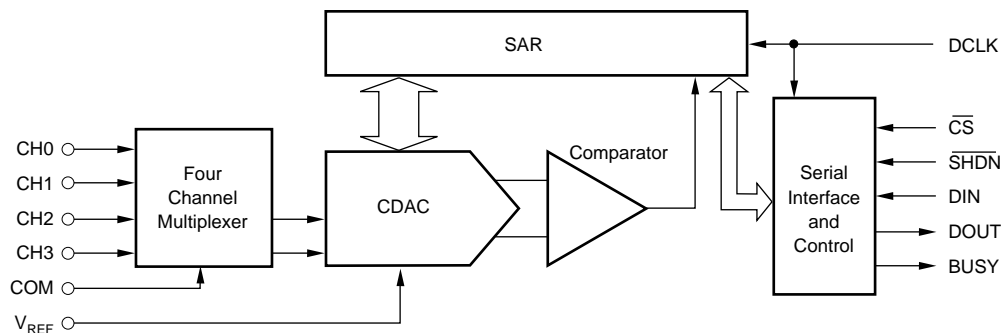

Please be aware that an important notice concerning availability, standard warranty, and use in critical applications of Texas Instruments semiconductor products and disclaimers thereto appears at the end of this data sheet.

## ABSOLUTE MAXIMUM RATINGS<sup>(1)</sup>

+V <sub>CC</sub> to GND .....	-0.3V to +6V
Analog Inputs to GND .....	-0.3V to +V <sub>CC</sub> + 0.3V
Digital Inputs to GND .....	-0.3V to +6V
Power Dissipation .....	250mW
Maximum Junction Temperature .....	+150°C
Operating Temperature Range .....	-40°C to +85°C
Storage Temperature Range .....	-65°C to +150°C
Lead Temperature (soldering, 10s) .....	+300°C

NOTE: (1) Stresses above those listed under "Absolute Maximum Ratings" may cause permanent damage to the device. Exposure to absolute maximum conditions for extended periods may affect device reliability.



## ELECTROSTATIC DISCHARGE SENSITIVITY

This integrated circuit can be damaged by ESD. Texas Instruments recommends that all integrated circuits be handled with appropriate precautions. Failure to observe proper handling and installation procedures can cause damage.

ESD damage can range from subtle performance degradation to complete device failure. Precision integrated circuits may be more susceptible to damage because very small parametric changes could cause the device not to meet its published specifications.

## PIN CONFIGURATIONS

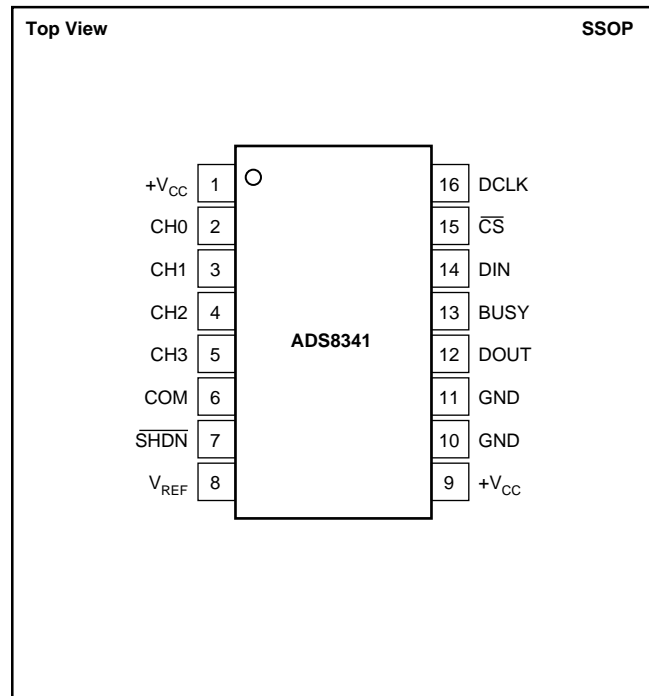

## PIN DESCRIPTIONS

PIN	NAME	DESCRIPTION
1	+V <sub>CC</sub>	Power Supply, 2.7V to 5V
2	CH0	Analog Input Channel 0
3	CH1	Analog Input Channel 1
4	CH2	Analog Input Channel 2
5	CH3	Analog Input Channel 3
6	COM	Ground Reference for Analog Inputs. Sets zero code voltage in single-ended mode. Connect this pin to ground or ground reference point.
7	SHDN	Shutdown. When LOW, the device enters a very low power shutdown mode.
8	V <sub>REF</sub>	Voltage Reference Input. See Electrical Characteristics Table for ranges.
9	+V <sub>CC</sub>	Power Supply, 2.7V to 5V
10	GND	Ground. Connect to Analog Ground
11	GND	Ground. Connect to Analog Ground.
12	DOUT	Serial Data Output. Data is shifted on the falling edge of DCLK. This output is high impedance when CS is HIGH.
13	BUSY	Busy Output. This output is high impedance when CS is HIGH.
14	DIN	Serial Data Input. If CS is LOW, data is latched on rising edge of DCLK.
15	CS	Chip Select Input. Controls conversion timing and enables the serial input/output register.
16	DCLK	External Clock Input. This clock runs the SAR conversion process and synchronizes serial data I/O. Maximum input clock frequency equals 2.4MHz to achieve 100kHz sampling rate.

## PACKAGE/ORDERING INFORMATION

PRODUCT	MAXIMUM INTEGRAL LINEARITY ERROR (LSB)	NO MISSING CODES ERROR (LSB)	SPECIFICATION TEMPERATURE RANGE	PACKAGE	PACKAGE DESIGNATOR <sup>(1)</sup>	ORDERING NUMBER	TRANSPORT MEDIA
ADS8341E	8	14	-40°C to +85°C	SSOP-16	DBQ	ADS8341E	Rails
"	"	"	"	"	"	ADS8341E/2K5	Tape and Reel
ADS8341EB	6	15	-40°C to +85°C	SSOP-16	DBQ	ADS8341EB	Rails
"	"	"	"	"	"	ADS8341EB/2K5	Tape and Reel

NOTE: (1) For the most current specifications and package information, refer to our web site [www.ti.com](http://www.ti.com).

# ELECTRICAL CHARACTERISTICS: +5V

At  $T_A = -40^{\circ}\text{C}$  to  $+85^{\circ}\text{C}$ ,  $+V_{CC} = +5\text{V}$ ,  $V_{REF} = +5\text{V}$ ,  $f_{SAMPLE} = 100\text{kHz}$ , and  $f_{CLK} = 24 \cdot f_{SAMPLE} = 2.4\text{MHz}$ , unless otherwise noted.

PARAMETER	CONDITIONS	ADS8341E, P			ADS8341EB, PB			UNITS
		MIN	TYP	MAX	MIN	TYP	MAX	
<b>RESOLUTION</b>				16			*	<b>BITS</b>
<b>ANALOG INPUT</b>								
Full-Scale Input Span	Positive Input - Negative Input	0		$V_{REF}$	*		*	V
Absolute Input Range	Positive Input	-0.2		$+V_{CC} + 0.2$	*		*	V
	Negative Input	-0.2		+1.25	*		*	V
Capacitance			25			*		pF
Leakage Current			$\pm 1$			*		$\mu\text{A}$
<b>SYSTEM PERFORMANCE</b>								
No Missing Codes		14			15			Bits
Integral Linearity Error				$\pm 8$			$\pm 6$	LSB
Offset Error				$\pm 2$			$\pm 1$	mV
Offset Error Match			1.2	4.0		*	*	LSB <sup>(1)</sup>
Gain Error				$\pm 0.05$		*	$\pm 0.024$	%
Gain Error Match			1.0	4.0		*	*	LSB
Noise			20			*		$\mu\text{V}_{\text{rms}}$
Power-Supply Rejection	$+4.75\text{V} < V_{CC} < 5.25\text{V}$		3			*		LSB <sup>(1)</sup>
<b>SAMPLING DYNAMICS</b>								
Conversion Time				16			*	Clk Cycles
Acquisition Time		4.5			*		*	Clk Cycles
Throughput Rate				100			*	kHz
Multiplexer Settling Time			500			*		ns
Aperture Delay			30			*		ns
Aperture Jitter			100			*		ps
Internal Clock Frequency	$\overline{\text{SHDN}} = V_{DD}$		2.4			*		MHz
External Clock Frequency	Data Transfer Only	0.024		2.4	*		*	MHz
		0		2.4	*		*	MHz
<b>DYNAMIC CHARACTERISTICS</b>								
Total Harmonic Distortion <sup>(2)</sup>	$V_{IN} = 5\text{Vp-p}$ at 10kHz		-90			*		dB
Signal-to-(Noise + Distortion)	$V_{IN} = 5\text{Vp-p}$ at 10kHz		86			*		dB
Spurious-Free Dynamic Range	$V_{IN} = 5\text{Vp-p}$ at 10kHz		92			*		dB
Channel-to-Channel Isolation	$V_{IN} = 5\text{Vp-p}$ at 50kHz		100			*		dB
<b>REFERENCE INPUT</b>								
Range		0.5		$+V_{CC}$	*		*	V
Resistance	DCLK Static		5			*		$\text{G}\Omega$
Input Current	$f_{SAMPLE} = 12.5\text{kHz}$		40	100		*	*	$\mu\text{A}$
	DCLK Static		2.5			*	*	$\mu\text{A}$
			0.001	3		*	*	$\mu\text{A}$
<b>DIGITAL INPUT/OUTPUT</b>								
Logic Family			CMOS			*		
Logic Levels						*		
$V_{IH}$	$ I_{IH}  \leq +5\mu\text{A}$	3.0		5.5	*		*	V
$V_{IL}$	$ I_{IL}  \leq +5\mu\text{A}$	-0.3		+0.8	*		*	V
$V_{OH}$	$I_{OH} = -250\mu\text{A}$	3.5			*		*	V
$V_{OL}$	$I_{OL} = 250\mu\text{A}$			0.4			*	V
Data Format				Straight Binary		*		
<b>POWER SUPPLY REQUIREMENTS</b>								
$+V_{CC}$	Specified Performance	4.75		5.25	*		*	V
Quiescent Current	$f_{SAMPLE} = 12.5\text{kHz}$		1.5	2.0			*	mA
	Power-Down Mode <sup>(3)</sup> , $\overline{\text{CS}} = +V_{CC}$		300			*		$\mu\text{A}$
Power Dissipation			7.5	10			*	mW
<b>TEMPERATURE RANGE</b>								
Specified Performance		-40		+85	*		*	$^{\circ}\text{C}$

\* Same specifications as ADS8341E.

NOTES: (1) LSB means Least Significant Bit. With  $V_{REF}$  equal to +5.0V, one LSB is 76 $\mu\text{V}$ . (2) First five harmonics of the test frequency. (3) Auto power-down mode ( $\text{PD1} = \text{PD0} = 0$ ) active or  $\overline{\text{SHDN}} = \text{GND}$ .

# ELECTRICAL CHARACTERISTICS: +2.7V

At  $T_A = -40^{\circ}\text{C}$  to  $+85^{\circ}\text{C}$ ,  $+V_{CC} = +2.7\text{V}$ ,  $V_{REF} = +2.5\text{V}$ ,  $f_{SAMPLE} = 100\text{kHz}$ , and  $f_{CLK} = 24 \cdot f_{SAMPLE} = 2.4\text{MHz}$ , unless otherwise noted.

PARAMETER	CONDITIONS	ADS8341E, P			ADS8341EB, PB			UNITS
		MIN	TYP	MAX	MIN	TYP	MAX	
<b>RESOLUTION</b>				16			*	<b>BITS</b>
<b>ANALOG INPUT</b>								
Full-Scale Input Span	Positive Input - Negative Input	0		$V_{REF}$	*		*	V
Absolute Input Range	Positive Input	-0.2		$+V_{CC} + 0.2$	*		*	V
	Negative Input	-0.2		+0.2	*		*	V
Capacitance			25			*		pF
Leakage Current			$\pm 1$			*		$\mu\text{A}$
<b>SYSTEM PERFORMANCE</b>								
No Missing Codes		14			15			Bits
Integral Linearity Error				$\pm 12$			$\pm 8$	LSB
Offset Error				$\pm 1$			$\pm 0.5$	mV
Offset Error Match			1.2	4.0		*	*	LSB
Gain Error				$\pm 0.05$			$\pm 0.0024$	% of FSR
Gain Error Match			1.0	4.0		*	*	LSB
Noise			20			*		$\mu\text{Vrms}$
Power-Supply Rejection	$+2.7 < V_{CC} < +3.3\text{V}$		3			*		LSB <sup>(1)</sup>
<b>SAMPLING DYNAMICS</b>								
Conversion Time				16			*	Clk Cycles
Acquisition Time		4.5			*		*	Clk Cycles
Throughput Rate				100			*	kHz
Multiplexer Settling Time			500			*		ns
Aperture Delay			30			*		ns
Aperture Jitter			100			*		ps
Internal Clock Frequency	$\overline{\text{SHDN}} = V_{DD}$		2.4			*		MHz
External Clock Frequency	When Used with Internal Clock Data Transfer Only	0.024 0.024 0		2.4 2.0 2.4	*	*	*	MHz MHz MHz
<b>DYNAMIC CHARACTERISTICS</b>								
Total Harmonic Distortion <sup>(2)</sup>	$V_{IN} = 2.5\text{Vp-p}$ at 10kHz			-90		*		dB
Signal-to-(Noise + Distortion)	$V_{IN} = 2.5\text{Vp-p}$ at 10kHz			86		*		dB
Spurious-Free Dynamic Range	$V_{IN} = 2.5\text{Vp-p}$ at 10kHz			92		*		dB
Channel-to-Channel Isolation	$V_{IN} = 2.5\text{Vp-p}$ at 50kHz			100		*		dB
<b>REFERENCE INPUT</b>								
Range		0.5		$+V_{CC}$	*		*	V
Resistance	DCLK Static		5			*		$\text{G}\Omega$
Input Current	$f_{SAMPLE} = 12.5\text{kHz}$ DCLK Static		13 2.5 0.001	40 3		*	*	$\mu\text{A}$ $\mu\text{A}$ $\mu\text{A}$
<b>DIGITAL INPUT/OUTPUT</b>								
Logic Family			CMOS			*		
Logic Levels								
$V_{IH}$	$ I_{IH}  \leq +5\mu\text{A}$	$+V_{CC} \cdot 0.7$		5.5	*		*	V
$V_{IL}$	$ I_{IL}  \leq +5\mu\text{A}$	-0.3		+0.8	*		*	V
$V_{OH}$	$I_{OH} = -250\mu\text{A}$	$+V_{CC} \cdot 0.8$			*		*	V
$V_{OL}$	$I_{OL} = 250\mu\text{A}$			0.4			*	V
Data Format				Straight Binary		*		
<b>POWER SUPPLY REQUIREMENTS</b>								
$+V_{CC}$	Specified Performance	2.7		3.6	*		*	V
Quiescent Current	$f_{SAMPLE} = 12.5\text{kHz}$		1.2 220	1.85		*	*	mA $\mu\text{A}$
Power Dissipation	Power-Down Mode <sup>(3)</sup> , $\overline{\text{CS}} = +V_{CC}$		3.2	5			*	$\mu\text{A}$ mW
<b>TEMPERATURE RANGE</b>								
Specified Performance		-40		+85	*		*	$^{\circ}\text{C}$

\* Same specifications as ADS8341E.

NOTES: (1) LSB means Least Significant Bit. With  $V_{REF}$  equal to +5.0V, one LSB is 76 $\mu\text{V}$ . (2) First five harmonics of the test frequency. (3) Auto power-down mode (PD1 = PD0 = 0) active or SHDN = GND.

# TYPICAL CHARACTERISTICS: +5V

At  $T_A = +25^\circ\text{C}$ ,  $+V_{CC} = +5\text{V}$ ,  $V_{REF} = +5\text{V}$ ,  $f_{\text{SAMPLE}} = 100\text{kHz}$ , and  $f_{\text{CLK}} = 24 \cdot f_{\text{SAMPLE}} = 2.4\text{MHz}$ , unless otherwise noted.

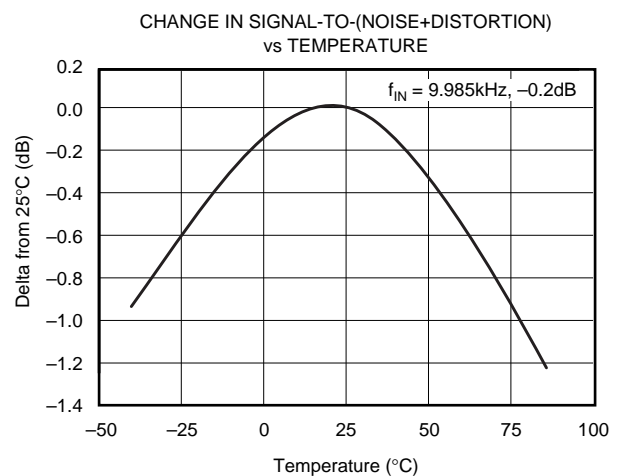
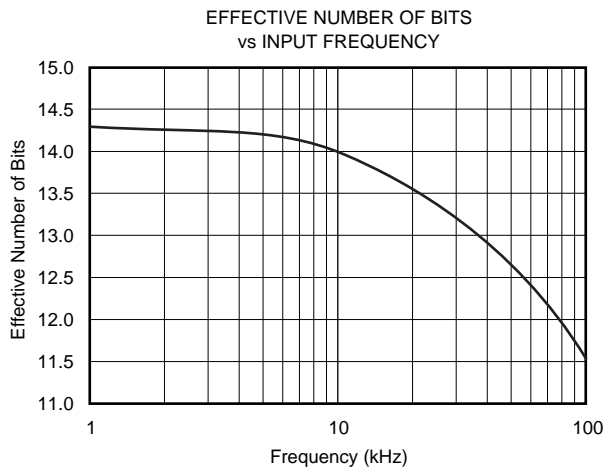
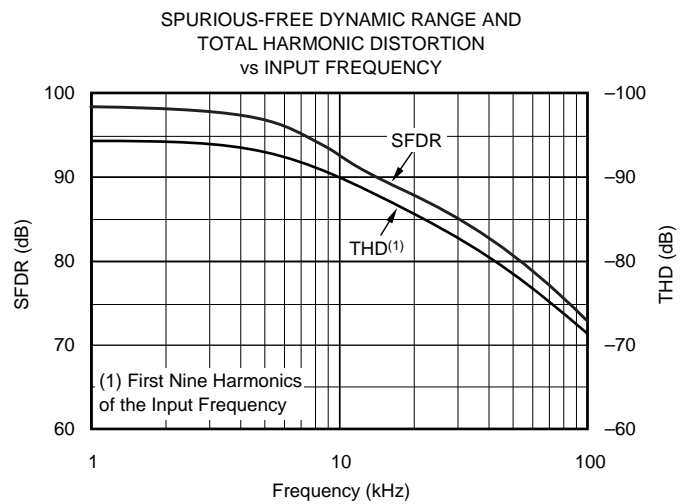
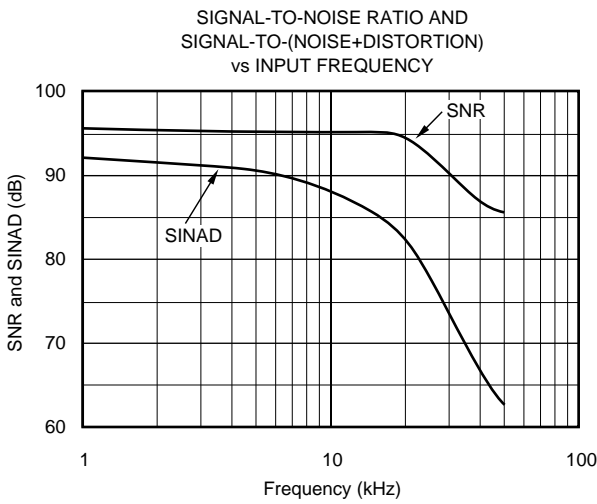
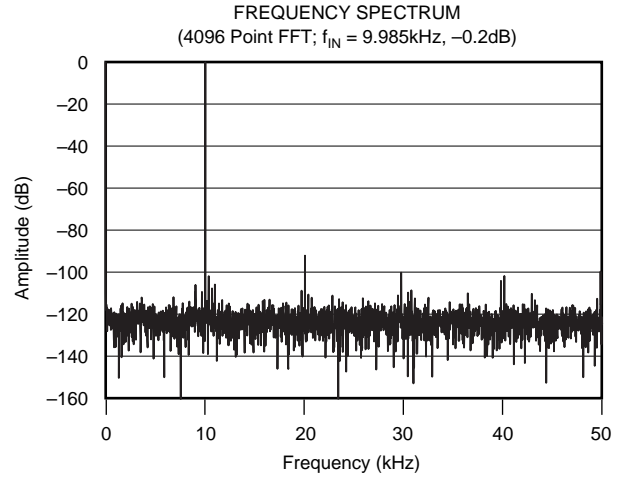
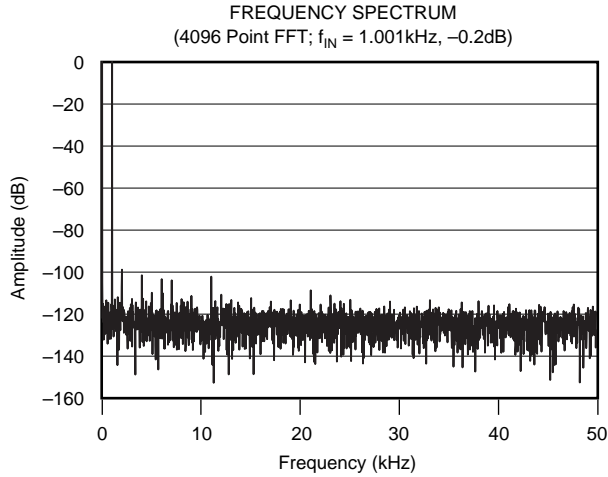

# TYPICAL CHARACTERISTICS: +5V (Cont.)

At  $T_A = +25^\circ\text{C}$ ,  $+V_{CC} = +5\text{V}$ ,  $V_{REF} = +5\text{V}$ ,  $f_{\text{SAMPLE}} = 100\text{kHz}$ , and  $f_{\text{CLK}} = 24 \cdot f_{\text{SAMPLE}} = 2.4\text{MHz}$ , unless otherwise noted.

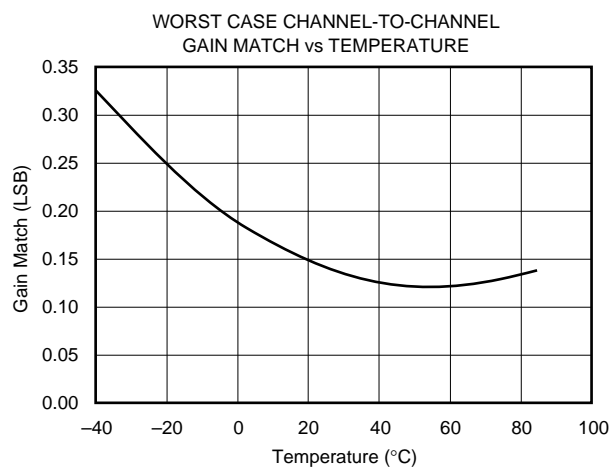
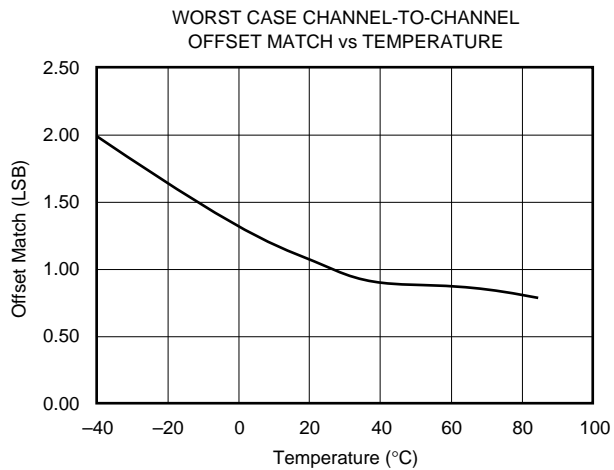
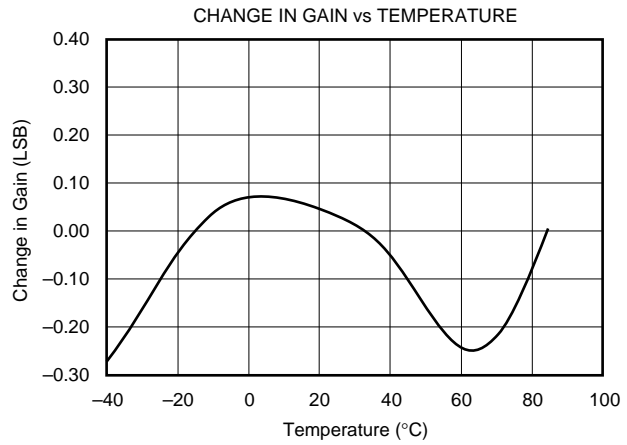
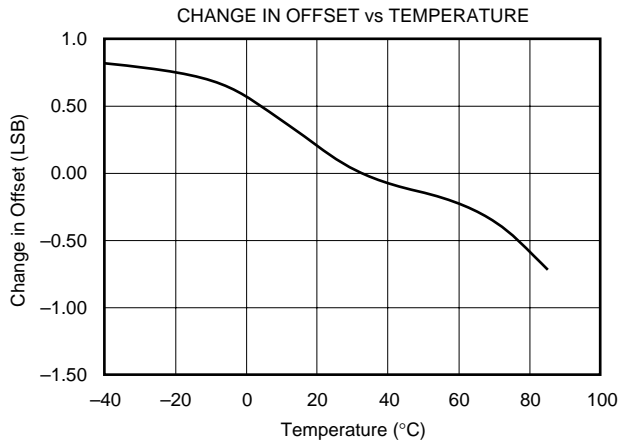
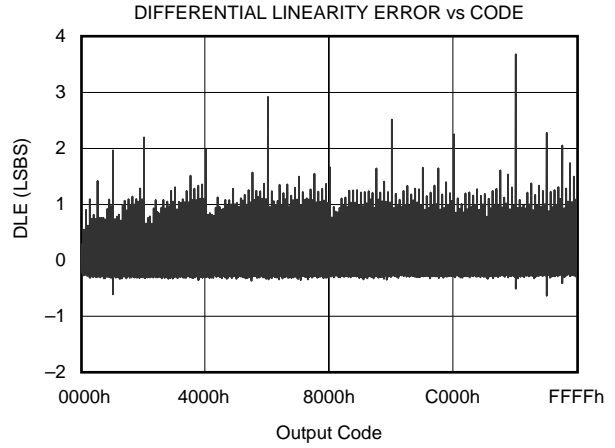
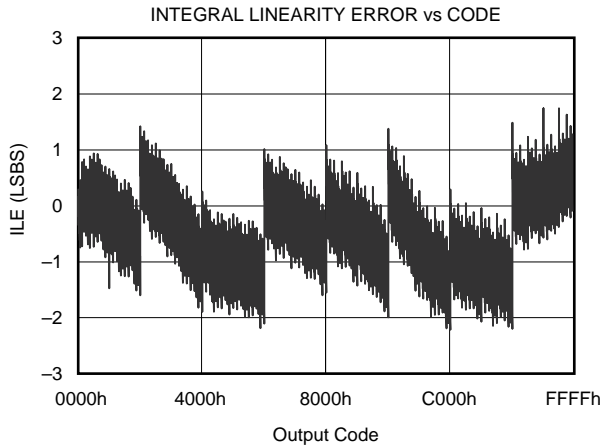

# TYPICAL CHARACTERISTICS: +5V (Cont.)

At  $T_A = +25^\circ\text{C}$ ,  $+V_{CC} = +5\text{V}$ ,  $V_{REF} = +5\text{V}$ ,  $f_{\text{SAMPLE}} = 100\text{kHz}$ , and  $f_{\text{CLK}} = 24 \cdot f_{\text{SAMPLE}} = 2.4\text{MHz}$ , unless otherwise noted.

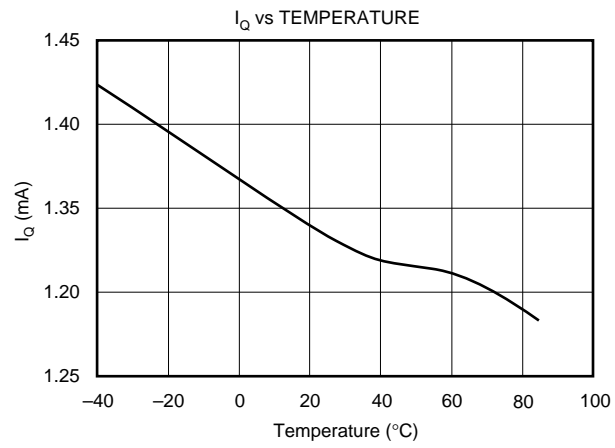

# TYPICAL CHARACTERISTICS: +2.7V

At  $T_A = +25^\circ\text{C}$ ,  $+V_{CC} = +2.7\text{V}$ ,  $V_{REF} = +2.5\text{V}$ ,  $f_{\text{SAMPLE}} = 100\text{kHz}$ , and  $f_{\text{CLK}} = 24 \cdot f_{\text{SAMPLE}} = 2.4\text{MHz}$ , unless otherwise noted.

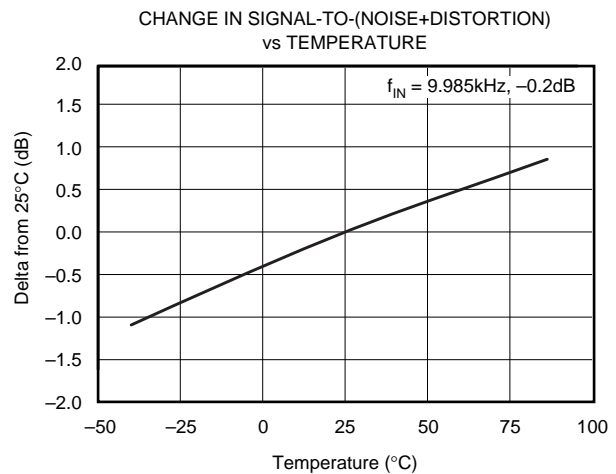
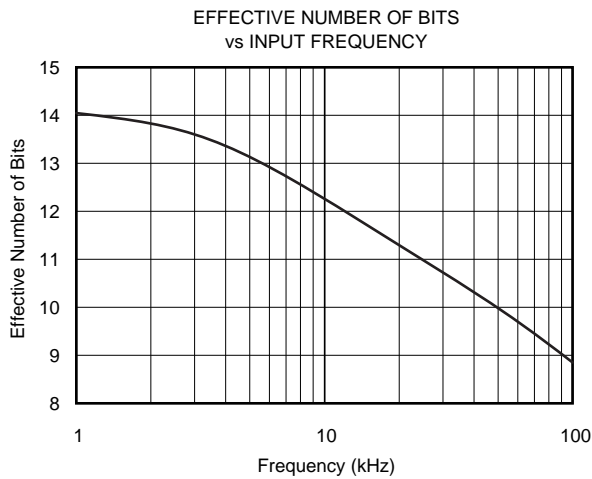
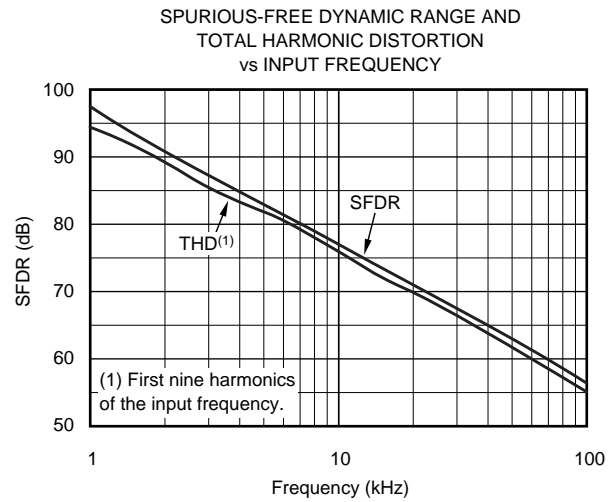
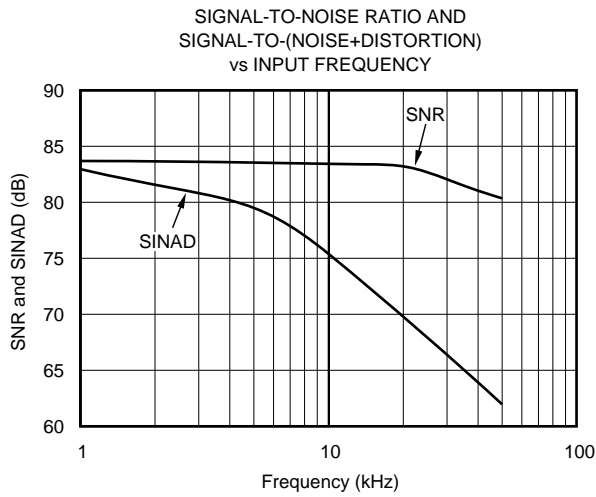
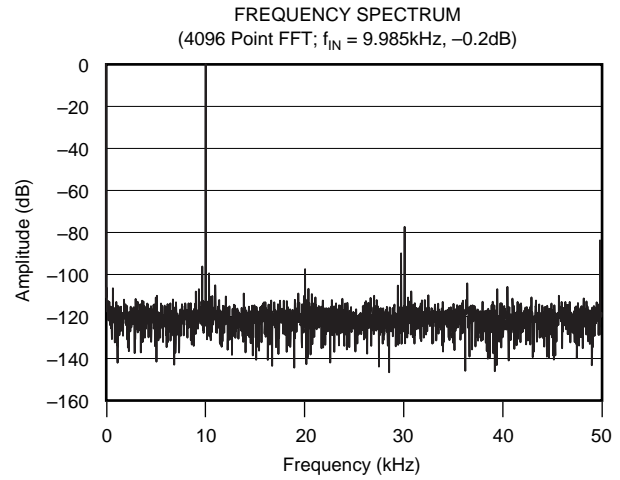
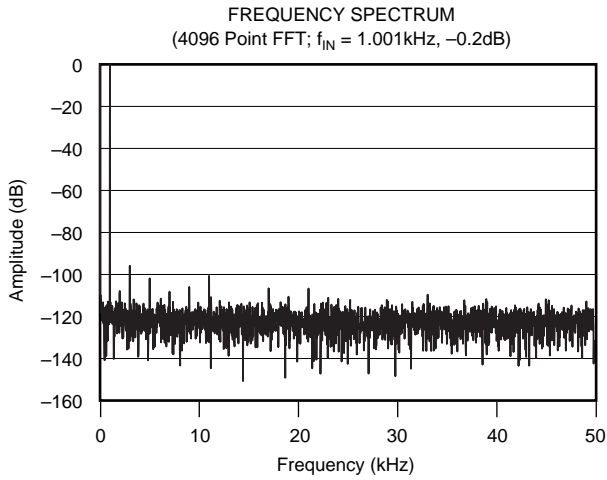

# TYPICAL CHARACTERISTICS: +2.7V (Cont.)

At  $T_A = +25^\circ\text{C}$ ,  $+V_{CC} = +2.7\text{V}$ ,  $V_{REF} = +2.5\text{V}$ ,  $f_{\text{SAMPLE}} = 100\text{kHz}$ , and  $f_{\text{CLK}} = 24 \cdot f_{\text{SAMPLE}} = 2.4\text{MHz}$ , unless otherwise noted.

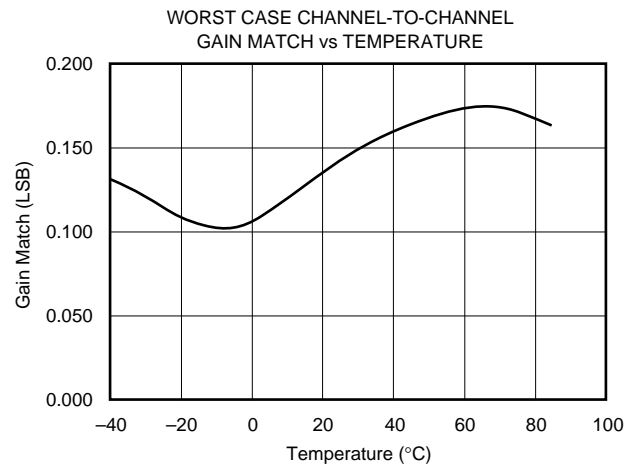
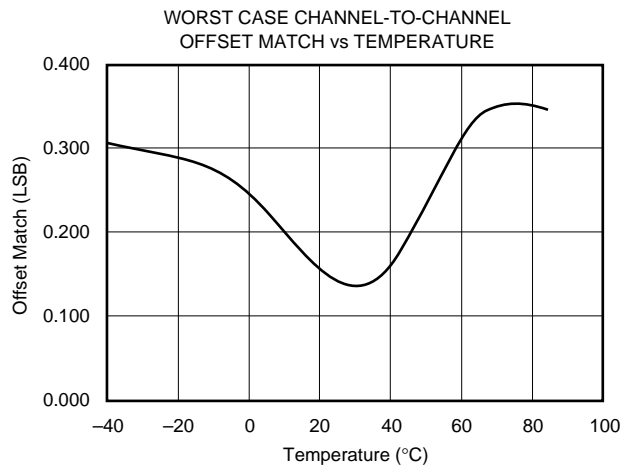
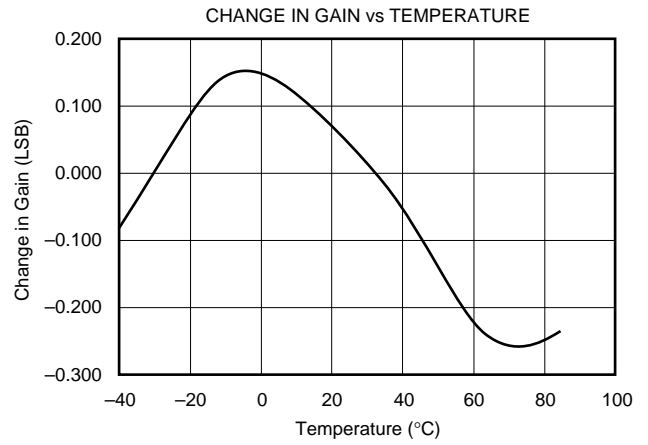
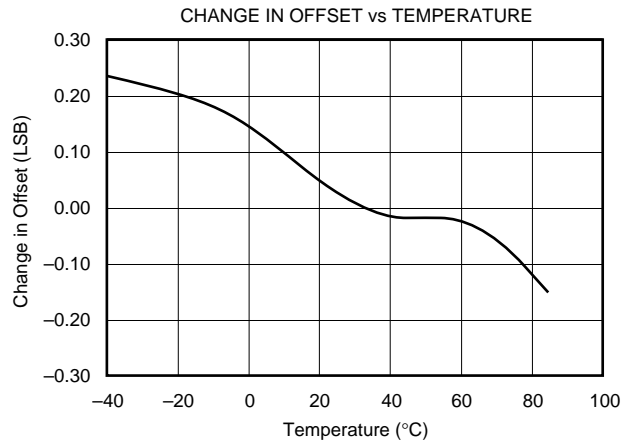
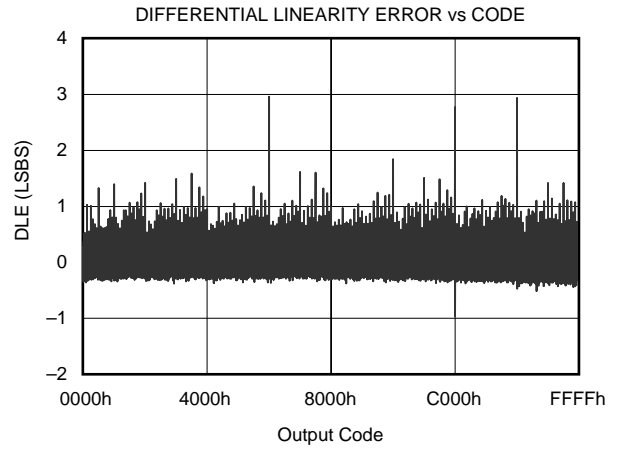
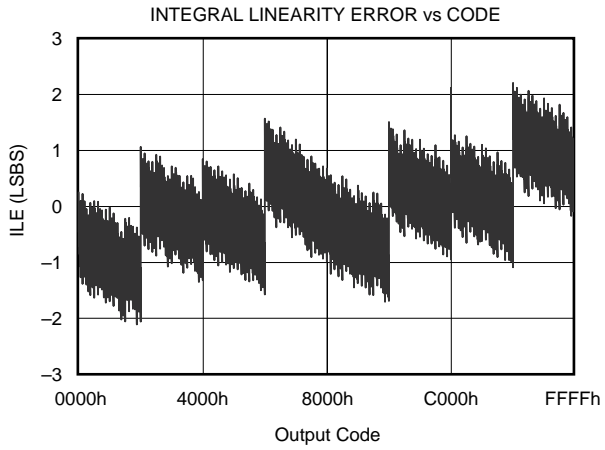

# TYPICAL CHARACTERISTICS: +2.7V (Cont.)

At  $T_A = +25^\circ\text{C}$ ,  $+V_{CC} = +2.7\text{V}$ ,  $V_{REF} = +2.5\text{V}$ ,  $f_{\text{SAMPLE}} = 100\text{kHz}$ , and  $f_{\text{CLK}} = 24 \cdot f_{\text{SAMPLE}} = 2.4\text{MHz}$ , unless otherwise noted.

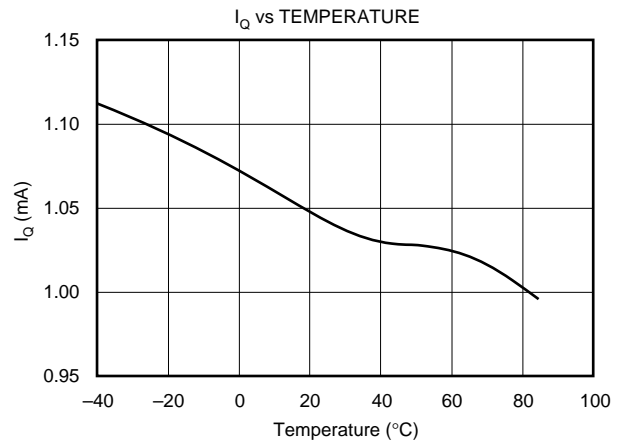
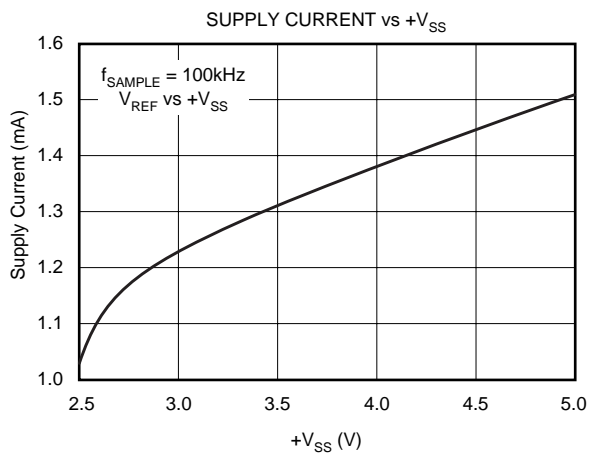

# THEORY OF OPERATION

The ADS8341 is a classic Successive Approximation Register (SAR) A/D converter. The architecture is based on capacitive redistribution which inherently includes a sample-and-hold function. The converter is fabricated on a 0.6 $\mu$ m CMOS process.

The basic operation of the ADS8341 is shown in Figure 1. The device requires an external reference and an external clock. It operates from a single supply of 2.7V to 5.25V. The external reference can be any voltage between 500mV and +V<sub>CC</sub>. The value of the reference voltage directly sets the input range of the converter. The average reference input current depends on the conversion rate of the ADS8341.

The analog input to the converter is differential and is provided via a four-channel multiplexer. The input can be provided in reference to a voltage on the COM pin (which is generally ground) or differentially by using two of the four input channels (CH0 - CH3). The particular configuration is selectable via the digital interface.

## ANALOG INPUT

Figure 2 shows a block diagram of the input multiplexer on the ADS8341. The differential input of the converter is derived from one of the four inputs in reference to the COM pin or two of the four inputs. Table I and Table II show the relationship between the A2, A1, A0, and SGL/DIF control bits and the configuration of the analog multiplexer. The control bits are provided serially via the DIN pin, see the Digital Interface section of this data sheet for more details.

When the converter enters the hold mode, the voltage difference between the +IN and -IN inputs, as shown in Figure 2, is captured on the internal capacitor array. The voltage on the -IN input is limited between -0.2V and 1.25V, allowing the input to reject small signals that are common to both the +IN and -IN input. The +IN input has a range of -0.2V to +V<sub>CC</sub> + 0.2V.

The input current on the analog inputs depends on the conversion rate of the device. During the sample period, the source must charge the internal sampling capacitor (typically 25pF). After the capacitor has been fully charged, there is no further input current. The rate of charge transfer from the analog source to the converter is a function of conversion rate.

A2	A1	A0	CH0	CH1	CH2	CH3	COM
0	0	1	+IN				-IN
1	0	1		+IN			-IN
0	1	0			+IN		-IN
1	1	0				+IN	-IN

TABLE I. Single-Ended Channel Selection (SGL/DIF HIGH).

A2	A1	A0	CH0	CH1	CH2	CH3	COM
0	0	1	+IN	-IN			
1	0	1	-IN	+IN			
0	1	0			+IN	-IN	
1	1	0			-IN	+IN	

TABLE II. Differential Channel Control (SGL/DIF LOW).

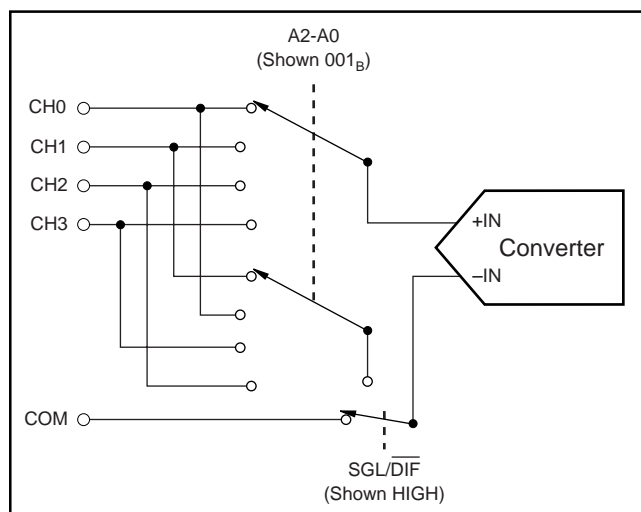

FIGURE 2. Simplified Diagram of the Analog Input.

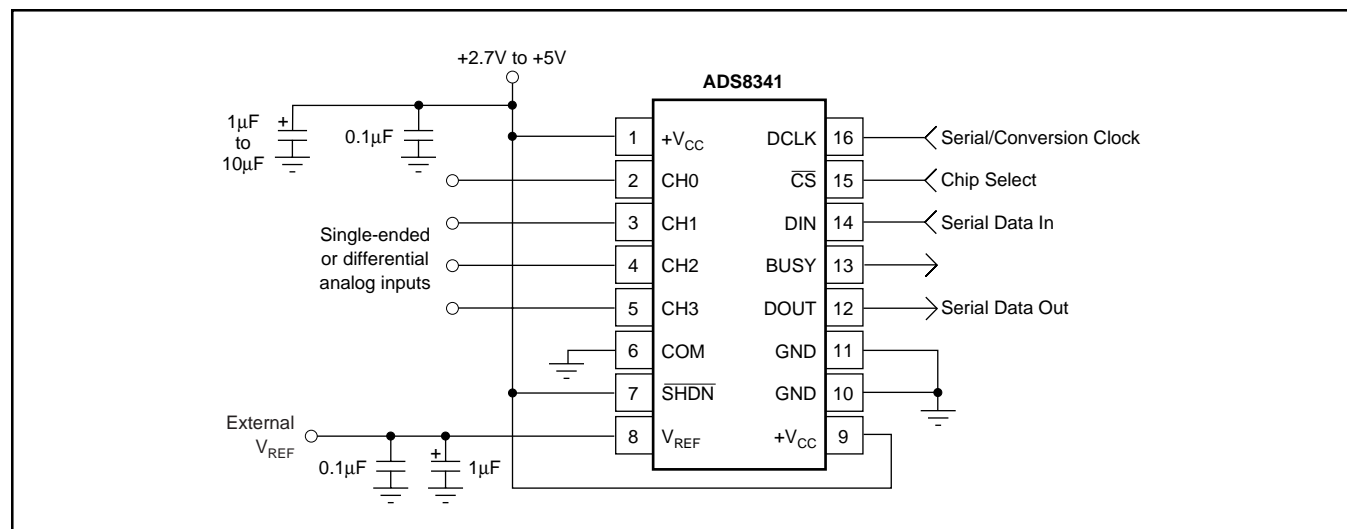

FIGURE 1. Basic Operation of the ADS8341.

## REFERENCE INPUT

The external reference sets the analog input range. The ADS8341 will operate with a reference in the range of 500mV to +V<sub>CC</sub>. Keep in mind that the analog input is the difference between the +IN input and the -IN input, see Figure 2. For example, in the single-ended mode, a 1.25V reference, with the COM pin grounded, the selected input channel (CH0 - CH3) will properly digitize a signal in the range of 0V to 1.25V. If the COM pin is connected to 0.5V, the input range on the selected channel is 0.5V to 1.75V.

There are several critical items concerning the reference input and its wide voltage range. As the reference voltage is reduced, the analog voltage weight of each digital output code is also reduced. This is often referred to as the LSB (least significant bit) size and is equal to the reference voltage divided by 65,536. Any offset or gain error inherent in the A/D converter will appear to increase, in terms of LSB size, as the reference voltage is reduced. For example, if the offset of a given converter is 2LSBs with a 2.5V reference, then it will typically be 10LSBs with a 0.5V reference. In each case, the actual offset of the device is the same, 76μV.

Likewise, the noise or uncertainty of the digitized output will increase with lower LSB size. With a reference voltage of 500mV, the LSB size is 7.6μV. This level is below the internal noise of the device. As a result, the digital output code will not be stable and vary around a mean value by a number of LSBs. The distribution of output codes will be gaussian and the noise can be reduced by simply averaging consecutive conversion results or applying a digital filter.

With a lower reference voltage, care should be taken to provide a clean layout including adequate bypassing, a clean (low-noise, low-ripple) power supply, a low-noise reference, and a low-noise input signal. Because the LSB size is lower, the converter will also be more sensitive to nearby digital signals and electromagnetic interference.

The voltage into the V<sub>REF</sub> input is not buffered and directly drives the Capacitor Digital-to-Analog Converter (CDAC) portion of the ADS8341. Typically, the input current is 13μA with a 2.5V reference. This value will vary by microamps depending on the result of the conversion. The reference current diminishes directly with both conversion

rate and reference voltage. As the current from the reference is drawn on each bit decision, clocking the converter more quickly during a given conversion period will not reduce overall current drain from the reference.

## DIGITAL INTERFACE

Figure 3 shows the typical operation of the ADS8341's digital interface. This diagram assumes that the source of the digital signals is a microcontroller or digital signal processor with a basic serial interface (note that the digital inputs are over-voltage tolerant up to 5.5V, regardless of +V<sub>CC</sub>). Each communication between the processor and the converter consists of eight clock cycles. One complete conversion can be accomplished with three serial communications, for a total of 24 clock cycles on the DCLK input.

The first eight cycles are used to provide the control byte via the DIN pin. When the converter has enough information about the following conversion to set the input multiplexer appropriately, it enters the acquisition (sample) mode. After three more clock cycles, the control byte is complete and the converter enters the conversion mode. At this point, the input sample-and-hold goes into the hold mode. The next 16 clock cycles accomplish the actual analog-to-digital conversion.

### Control Byte

Also shown in Figure 3 is the placement and order of the control bits within the control byte. Tables III and IV give detailed information about these bits. The first bit, the 'S' bit, must always be HIGH and indicates the start of the control byte. The ADS8341 will ignore inputs on the DIN pin until the start bit is detected. The next three bits (A2 - A0) select the active input channel or channels of the input multiplexer (see Tables I and II and Figure 2).

Bit 7 (MSB)	Bit 6	Bit 5	Bit 4	Bit 3	Bit 2	Bit 1	Bit 0 (LSB)
S	A2	A1	A0	—	SGL/DIF	PD1	PD0

TABLE III. Order of the Control Bits in the Control Byte.

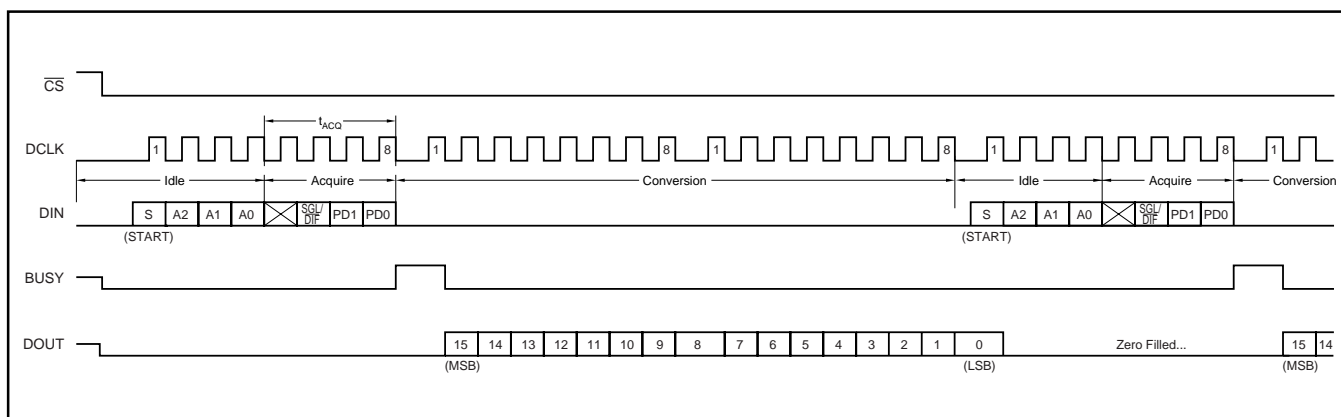

FIGURE 3. Conversion Timing, 24-Clocks per Conversion, 8-Bit Bus Interface. No DCLK delay required with dedicated serial port.

BIT	NAME	DESCRIPTION
7	S	Start Bit. Control byte starts with first HIGH bit on DIN.
6 - 4	A2 - A0	Channel Select Bits. Along with the SGL/DIF bit, these bits control the setting of the multiplexer input, see Tables I and II.
2	SGL/DIF	Single-Ended/Differential Select Bit. Along with bits A2 - A0, this bit controls the setting of the multiplexer input, see Tables I and II.
1 - 0	PD1 - PD0	Power-Down Mode Select Bits. See Table V for details.

TABLE IV. Descriptions of the Control Bits within the Control Byte.

The SGL/DIF bit controls the multiplexer input mode: either single-ended (HIGH) or differential (LOW). In single-ended mode, the selected input channel is referenced to the COM pin. In differential mode, the two selected inputs provide a differential input. See Tables I and II and Figure 2 for more information. The last two bits (PD1 - PD0) select the power-down mode, as shown in Table V. If both inputs are HIGH, the device is always powered up. If both inputs are LOW, the device enters a power-down mode between conversions. When a new conversion is initiated, the device will resume normal operation instantly—no delay is needed to allow the device to power up and the very first conversion will be valid.

### Clock Modes

The ADS8341 can be used with an external serial clock or an internal clock to perform the successive-approximation conversion. In both clock modes, the external clock shifts data in and out of the device. Internal clock mode is selected when PD1 is HIGH and PD0 is LOW.

If the user decides to switch from one clock mode to the other, an extra conversion cycle will be required before the ADS8341 can switch to the new mode. The extra cycle is required because the PD0 and PD1 control bits need to be written to the ADS8341 prior to the change in clock modes.

When power is first applied to the ADS8341, the user must set the desired clock mode. It can be set by writing PD1 = 1 and PD0 = 0 for internal clock mode or PD1 = 1 and

PD1	PD0	Description
0	0	Power-down between conversions. When each conversion is finished, the converter enters a low power mode. At the start of the next conversion, the device instantly powers up to full power. There is no need for additional delays to assure full operation and the very first conversion is valid.
1	0	Selects Internal Clock Mode
0	1	Reserved for Future Use
1	1	No power-down between conversions, device always powered. Selects external clock mode.

TABLE V. Power-Down Selection.

PD0 = 1 for external clock mode. After enabling the required clock mode, only then should the ADS8341 be set to power-down between conversions (i.e., PD1 = PD0 = 0). The ADS8341 maintains the clock mode it was in prior to entering the power-down modes.

### External Clock Mode

In external clock mode, the external clock not only shifts data in and out of the ADS8341, it also controls the A/D conversion steps. BUSY will go HIGH for one clock period after the last bit of the control byte is shifted in. Successive-approximation bit decisions are made and appear at DOUT on each of the next 16 DCLK falling edges (see Figure 3). Figure 4 shows the BUSY timing in external clock mode.

Since one clock cycle of the serial clock is consumed with BUSY going high (while the MSB decision is being made), 16 additional clocks must be given to clock out all 16 bits of data; thus, one conversion takes a minimum of 25 clock cycles to fully read the data. Since most microprocessors communicate in 8-bit transfers, this means that an additional transfer must be made to capture the LSB.

There are two ways of handling this requirement. One is shown in Figure 3, where the beginning of the next control byte appears at the same time the LSB is being clocked out of the ADS8341. This method allows for maximum throughput and 24 clock cycles per conversion.

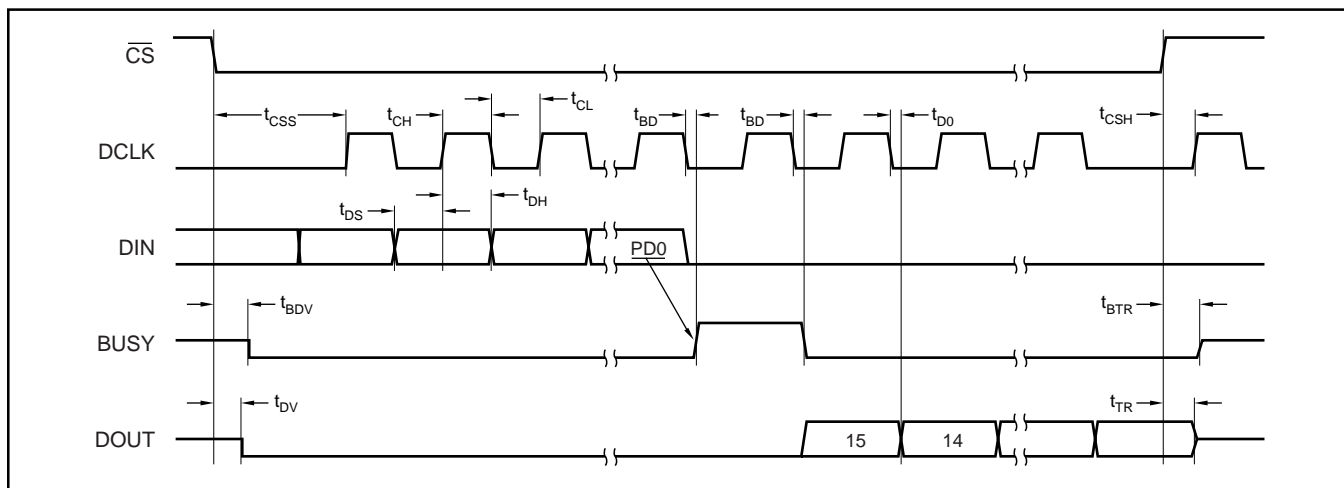

FIGURE 4. Detailed Timing Diagram.

The other method is shown in Figure 5, which uses 32 clock cycles per conversion; the last seven clock cycles simply shift out zeros on the DOUT line. BUSY and DOUT go into a high-impedance state when  $\overline{CS}$  goes high; after the next  $\overline{CS}$  falling edge, BUSY will go LOW.

### Internal Clock Mode

In internal clock mode, the ADS8341 generates its own conversion clock internally. This relieves the microprocessor from having to generate the SAR conversion clock and allows the conversion result to be read back at the processor's convenience, at any clock rate from 0MHz to 2.0MHz. BUSY goes LOW at the start of conversion and then returns HIGH when the conversion is complete. During the conversion, DCLK should remain LOW to achieve the best noise performance. The conversion result is stored in an internal register; the data may be clocked out of this register any time after the conversion is complete.

If  $\overline{CS}$  is LOW when BUSY goes LOW following a conversion, the next falling edge of the external serial clock will write out the MSB on the DOUT line. The remaining bits (D14-D0) will be clocked out on each successive clock cycle following the MSB. If  $\overline{CS}$  is HIGH when BUSY goes LOW then the DOUT line will remain in tri-state until  $\overline{CS}$  goes LOW, as shown in Figure 6.  $\overline{CS}$  does not need to remain LOW once a conversion has started. Note that BUSY is not tri-stated when  $\overline{CS}$  goes HIGH in internal clock mode.

Data can be shifted in and out of the ADS8341 at clock rates exceeding 2.4MHz, provided that the minimum acquisition time  $t_{ACQ}$  is kept above 1.7 $\mu$ s.

### Digital Timing

Figure 4 and Tables VI and VII provide detailed timing for the digital interface of the ADS8341.

SYMBOL	DESCRIPTION	MIN	TYP	MAX	UNITS
$t_{ACQ}$	Acquisition Time	1.5			$\mu$ s
$t_{DS}$	DIN Valid Prior to DCLK Rising	100			ns
$t_{DH}$	DIN Hold After DCLK HIGH	10			ns
$t_{DO}$	DCLK Falling to DOUT Valid			200	ns
$t_{DV}$	$\overline{CS}$ Falling to DOUT Enabled			200	ns
$t_{TR}$	$\overline{CS}$ Rising to DOUT Disabled			200	ns
$t_{CSS}$	$\overline{CS}$ Falling to First DCLK Rising	100			ns
$t_{CSH}$	$\overline{CS}$ Rising to DCLK Ignored	0			ns
$t_{CH}$	DCLK HIGH	200			ns
$t_{CL}$	DCLK LOW	200			ns
$t_{BD}$	DCLK Falling to BUSY Rising			200	ns
$t_{BDV}$	$\overline{CS}$ Falling to BUSY Enabled			200	ns
$t_{BTR}$	$\overline{CS}$ Rising to BUSY Disabled			200	ns

TABLE VI. Timing Specifications ( $+V_{CC} = +2.7V$  to  $3.6V$ ,  $T_A = -40^\circ C$  to  $+85^\circ C$ ,  $C_{LOAD} = 50pF$ ).

SYMBOL	DESCRIPTION	MIN	TYP	MAX	UNITS
$t_{ACQ}$	Acquisition Time	900			ns
$t_{DS}$	DIN Valid Prior to DCLK Rising	50			ns
$t_{DH}$	DIN Hold After DCLK HIGH	10			ns
$t_{DO}$	DCLK Falling to DOUT Valid			100	ns
$t_{DV}$	$\overline{CS}$ Falling to DOUT Enabled			70	ns
$t_{TR}$	$\overline{CS}$ Rising to DOUT Disabled			70	ns
$t_{CSS}$	$\overline{CS}$ Falling to First DCLK Rising	50			ns
$t_{CSH}$	$\overline{CS}$ Rising to DCLK Ignored	0			ns
$t_{CH}$	DCLK HIGH	150			ns
$t_{CL}$	DCLK LOW	150			ns
$t_{BD}$	DCLK Falling to BUSY Rising			100	ns
$t_{BDV}$	$\overline{CS}$ Falling to BUSY Enabled			70	ns
$t_{BTR}$	$\overline{CS}$ Rising to BUSY Disabled			70	ns

TABLE VII. Timing Specifications ( $+V_{CC} = +4.75V$  to  $+5.25V$ ,  $T_A = -40^\circ C$  to  $+85^\circ C$ ,  $C_{LOAD} = 50pF$ ).

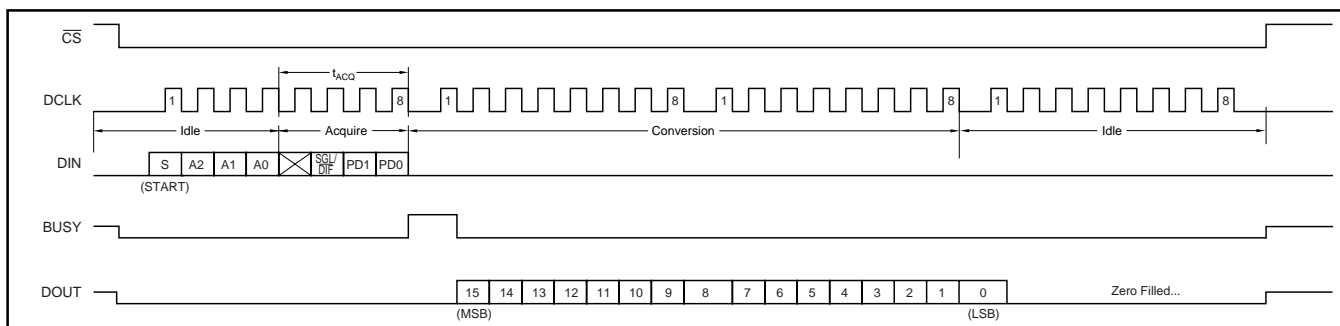

FIGURE 5. External Clock Mode 32 Clocks Per Conversion.

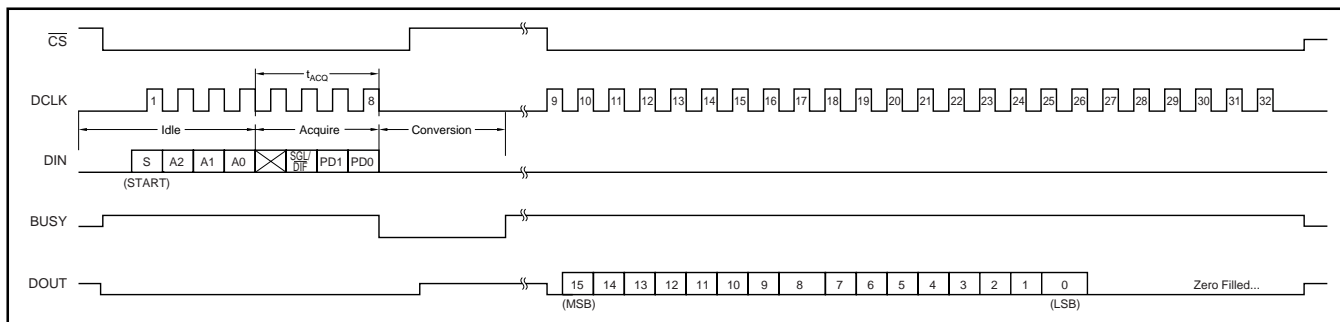

FIGURE 6. Internal Clock Mode Timing.

## Data Format

The ADS8341 output data is in straight binary format, as shown in Figure 7. This figure shows the ideal output code for the given input voltage and does not include the effects of offset, gain, or noise.

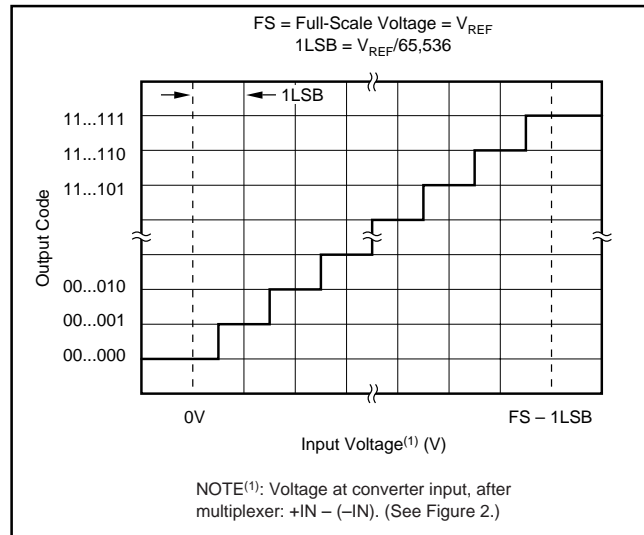

FIGURE 7. Ideal Input Voltages and Output Codes.

## POWER DISSIPATION

There are three power modes for the ADS8341: full power (PD1 - PD0 = 11B), auto power-down (PD1 - PD0 = 00B), and shutdown (SHDN LOW). The affects of these modes varies depending on how the ADS8341 is being operated. For example, at full conversion rate and 24-clocks per conversion, there is very little difference between full power mode and auto power-down, a shutdown (SHDN LOW) will not lower power dissipation.

When operating at full-speed and 24-clocks per conversion (as shown in Figure 3), the ADS8341 spends most of its time acquiring or converting. There is little time for auto power-down, assuming that this mode is active. Thus, the difference between full power mode and auto power-down is negligible. If the conversion rate is decreased by simply slowing the frequency of the DCLK input, the two modes remain approximately equal. However, if the DCLK frequency is kept at the maximum rate during a conversion, but conversion are simply done less often, then the difference between the two modes is dramatic. Figure 8 shows the difference between reducing the DCLK frequency (“scaling” DCLK to match the conversion rate) or maintaining DCLK at the highest frequency and reducing the number of conversion per second. In the later case, the converter spends an increasing percentage of its time in power-down mode (assuming the auto power-down mode is active).

If DCLK is active and  $\overline{CS}$  is LOW while the ADS8341 is in auto power-down mode, the device will continue to dissipate some power in the digital logic. The power can be reduced to a minimum by keeping  $\overline{CS}$  HIGH. The differences in supply current for these two cases are shown in Figure 9.

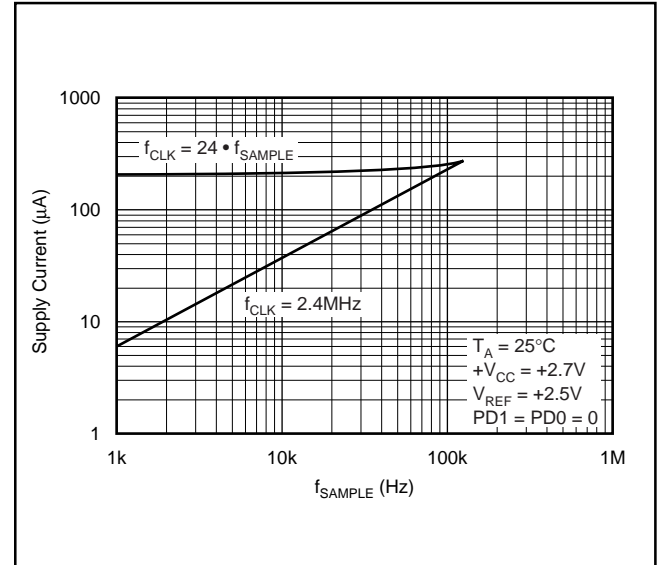

FIGURE 8. Supply Current versus Directly Scaling the Frequency of DCLK with Sample Rate or Keeping DCLK at the Maximum Possible Frequency.

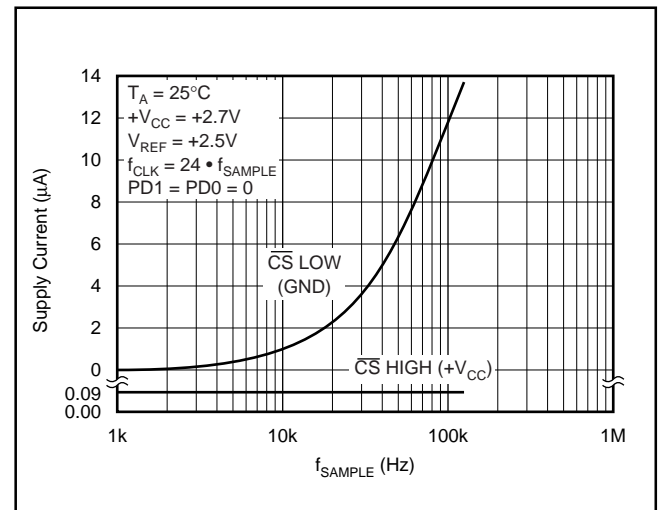

FIGURE 9. Supply Current versus State of  $\overline{CS}$ .

Operating the ADS8341 in auto power-down mode will result in the lowest power dissipation, and there is no conversion time “penalty” on power-up. The very first conversion will be valid. SHDN can be used to force an immediate power-down.

## NOISE

The noise floor of the ADS8341 itself is extremely low, as can be seen from Figures 10 thru 13, and is much lower than competing A/D converters. The ADS8341 was tested at both 5V and 2.7V and in both the internal and external clock modes. A low-level DC input was applied to the analog input pins and the converter was put through 5,000 conversions. The digital output of the A/D converter will vary in output code due to the internal noise of the ADS8341. This is true for all 16-bit SAR-type A/D converters. Using a histogram to plot the output codes, the distribution should appear bell-shaped with the peak of the bell curve representing the nominal code for the input value. The  $\pm 1\sigma$ ,  $\pm 2\sigma$ , and  $\pm 3\sigma$  distributions will represent the 68.3%, 95.5%, and 99.7%, respectively, of all codes. The transition noise can be calculated by dividing the number of codes measured by 6 and this will yield the  $\pm 3\sigma$  distribution or 99.7% of all codes. Statistically, up to 3 codes could fall outside the distribution when executing 1000 conversions. The ADS8341, with  $< 3$  output codes for the  $\pm 3\sigma$  distribution, will yield a  $< \pm 0.5$  LSB transition noise at 5V operation. Remember, to achieve this low noise performance, the peak-to-peak noise of the input signal and reference must be  $< 50\mu\text{V}$ .

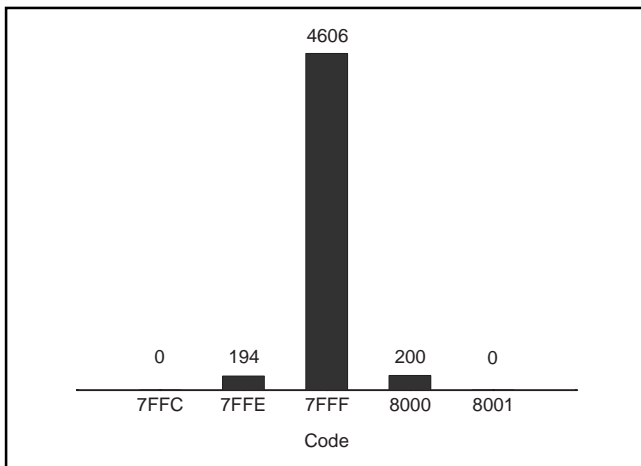

FIGURE 10. Histogram of 5,000 Conversions of a DC Input at the Code Transition, 5V operation external clock mode.

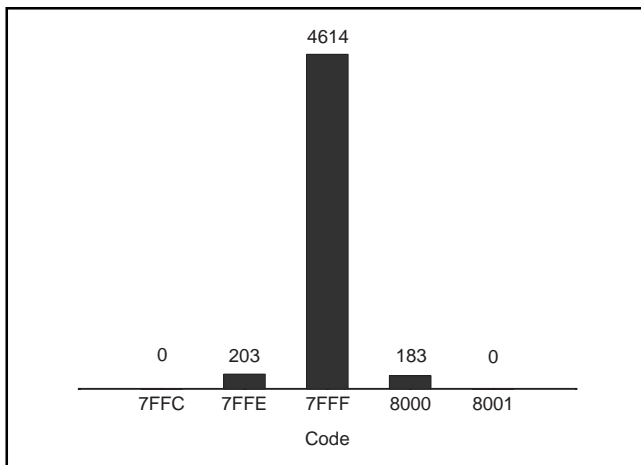

FIGURE 11. Histogram of 5,000 Conversions of a DC Input at the Code Center, 5V operation internal clock mode.

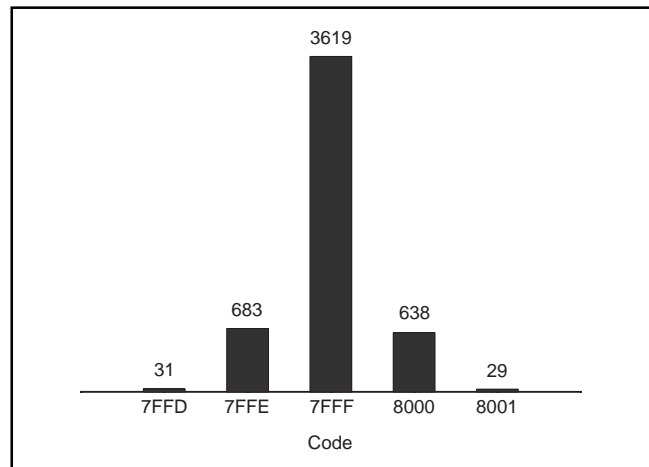

FIGURE 12. Histogram of 5,000 Conversions of a DC Input at the Code Transition, 2.7V operation external clock mode.

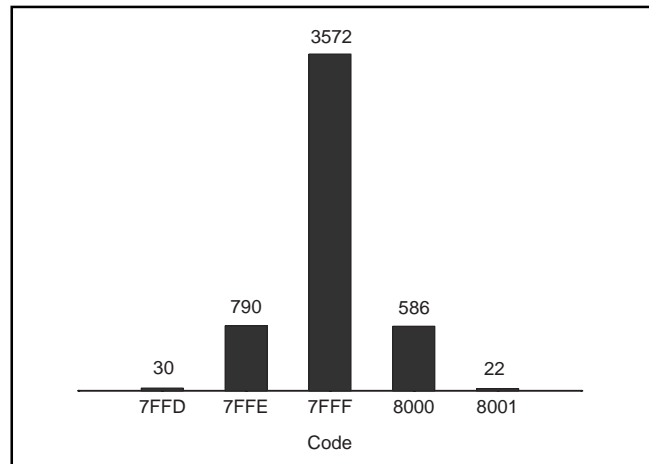

FIGURE 13. Histogram of 5,000 Conversions of a DC Input at the Code Center, 2.7V operation internal clock mode.

## AVERAGING

The noise of the A/D converter can be compensated by averaging the digital codes. By averaging conversion results, transition noise will be reduced by a factor of  $1/\sqrt{n}$ , where  $n$  is the number of averages. For example, averaging 4 conversion results will reduce the transition noise by  $1/2$  to  $\pm 0.25$  LSBs. Averaging should only be used for input signals with frequencies near DC.

For AC signals, a digital filter can be used to low-pass filter and decimate the output codes. This works in a similar manner to averaging; for every decimation by 2, the signal-to-noise ratio will improve 3dB.

## LAYOUT

For optimum performance, care should be taken with the physical layout of the ADS8341 circuitry. This is particularly true if the reference voltage is low and/or the conversion rate is high.

The basic SAR architecture is sensitive to glitches or sudden changes on the power supply, reference, ground connections, and digital inputs that occur just prior to latching the output of the analog comparator. Thus, during any single conversion for an n-bit SAR converter, there are n “windows” in which large external transient voltages can easily affect the conversion result. Such glitches might originate from switching power supplies, nearby digital logic, and high power devices. The degree of error in the digital output depends on the reference voltage, layout, and the exact timing of the external event. The error can change if the external event changes in time with respect to the DCLK input.

With this in mind, power to the ADS8341 should be clean and well bypassed. A 0.1 $\mu$ F ceramic bypass capacitor should be placed as close to the device as possible. In addition, a 1 $\mu$ F to 10 $\mu$ F capacitor and a 5 $\Omega$  or 10 $\Omega$  series resistor may be used to low-pass filter a noisy supply.

The reference should be similarly bypassed with a 0.1 $\mu$ F capacitor. Again, a series resistor and large capacitor can be used to low-pass filter the reference voltage. If the reference voltage originates from an op amp, make sure that it can drive the bypass capacitor without oscillation (the series resistor can help in this case). The ADS8341 draws very little current from the reference on average, but it does place larger demands on the reference circuitry over short periods of time (on each rising edge of DCLK during a conversion).

The ADS8341 architecture offers no inherent rejection of noise or voltage variation in regards to the reference input. This is of particular concern when the reference input is tied to the power supply. Any noise and ripple from the supply will appear directly in the digital results. While high frequency noise can be filtered out as discussed in the previous paragraph, voltage variation due to line frequency (50Hz or 60Hz) can be difficult to remove.

The GND pin should be connected to a clean ground point. In many cases, this will be the “analog” ground. Avoid connections that are too near the grounding point of a microcontroller or digital signal processor. If needed, run a ground trace directly from the converter to the power supply entry point. The ideal layout will include an analog ground plane dedicated to the converter and associated analog circuitry.

**PACKAGING INFORMATION**

Orderable Device	Status (1)	Package Type	Package Drawing	Pins	Package Qty	Eco Plan (2)	Lead/Ball Finish (6)	MSL Peak Temp (3)	Op Temp (°C)	Device Marking (4/5)	Samples
ADS8341E	ACTIVE	SSOP	DBQ	16	75	Green (RoHS & no Sb/Br)	CU NIPDAU	Level-2-260C-1 YEAR	-40 to 85	ADS 8341E	<a href="#">Samples</a>
ADS8341E/2K5	ACTIVE	SSOP	DBQ	16	2500	Green (RoHS & no Sb/Br)	CU NIPDAU	Level-2-260C-1 YEAR	-40 to 85	ADS 8341E	<a href="#">Samples</a>
ADS8341E/2K5G4	ACTIVE	SSOP	DBQ	16	2500	Green (RoHS & no Sb/Br)	CU NIPDAU	Level-2-260C-1 YEAR	-40 to 85	ADS 8341E	<a href="#">Samples</a>
ADS8341EB	ACTIVE	SSOP	DBQ	16	75	Green (RoHS & no Sb/Br)	CU NIPDAU	Level-2-260C-1 YEAR	-40 to 85	ADS 8341E B	<a href="#">Samples</a>
ADS8341EB/2K5	ACTIVE	SSOP	DBQ	16	2500	Green (RoHS & no Sb/Br)	CU NIPDAU	Level-2-260C-1 YEAR	-40 to 85	ADS 8341E B	<a href="#">Samples</a>
ADS8341EB/2K5G4	ACTIVE	SSOP	DBQ	16	2500	Green (RoHS & no Sb/Br)	CU NIPDAU	Level-2-260C-1 YEAR	-40 to 85	ADS 8341E B	<a href="#">Samples</a>

(1) The marketing status values are defined as follows:

**ACTIVE:** Product device recommended for new designs.

**LIFEBUY:** TI has announced that the device will be discontinued, and a lifetime-buy period is in effect.

**NRND:** Not recommended for new designs. Device is in production to support existing customers, but TI does not recommend using this part in a new design.

**PREVIEW:** Device has been announced but is not in production. Samples may or may not be available.

**OBSELETE:** TI has discontinued the production of the device.

(2) **RoHS:** TI defines "RoHS" to mean semiconductor products that are compliant with the current EU RoHS requirements for all 10 RoHS substances, including the requirement that RoHS substance do not exceed 0.1% by weight in homogeneous materials. Where designed to be soldered at high temperatures, "RoHS" products are suitable for use in specified lead-free processes. TI may reference these types of products as "Pb-Free".

**RoHS Exempt:** TI defines "RoHS Exempt" to mean products that contain lead but are compliant with EU RoHS pursuant to a specific EU RoHS exemption.

**Green:** TI defines "Green" to mean the content of Chlorine (Cl) and Bromine (Br) based flame retardants meet JS709B low halogen requirements of <=1000ppm threshold. Antimony trioxide based flame retardants must also meet the <=1000ppm threshold requirement.

(3) MSL, Peak Temp. - The Moisture Sensitivity Level rating according to the JEDEC industry standard classifications, and peak solder temperature.

(4) There may be additional marking, which relates to the logo, the lot trace code information, or the environmental category on the device.

(5) Multiple Device Markings will be inside parentheses. Only one Device Marking contained in parentheses and separated by a "-" will appear on a device. If a line is indented then it is a continuation of the previous line and the two combined represent the entire Device Marking for that device.

<sup>(6)</sup> Lead/Ball Finish - Orderable Devices may have multiple material finish options. Finish options are separated by a vertical ruled line. Lead/Ball Finish values may wrap to two lines if the finish value exceeds the maximum column width.

**Important Information and Disclaimer:** The information provided on this page represents TI's knowledge and belief as of the date that it is provided. TI bases its knowledge and belief on information provided by third parties, and makes no representation or warranty as to the accuracy of such information. Efforts are underway to better integrate information from third parties. TI has taken and continues to take reasonable steps to provide representative and accurate information but may not have conducted destructive testing or chemical analysis on incoming materials and chemicals. TI and TI suppliers consider certain information to be proprietary, and thus CAS numbers and other limited information may not be available for release.

In no event shall TI's liability arising out of such information exceed the total purchase price of the TI part(s) at issue in this document sold by TI to Customer on an annual basis.

**TAPE AND REEL INFORMATION**

**QUADRANT ASSIGNMENTS FOR PIN 1 ORIENTATION IN TAPE**

\*All dimensions are nominal

Device	Package Type	Package Drawing	Pins	SPQ	Reel Diameter (mm)	Reel Width W1 (mm)	A0 (mm)	B0 (mm)	K0 (mm)	P1 (mm)	W (mm)	Pin1 Quadrant
ADS8341E/2K5	SSOP	DBQ	16	2500	330.0	12.4	6.4	5.2	2.1	8.0	12.0	Q1
ADS8341EB/2K5	SSOP	DBQ	16	2500	330.0	12.4	6.4	5.2	2.1	8.0	12.0	Q1

TAPE AND REEL BOX DIMENSIONS



\*All dimensions are nominal

Device	Package Type	Package Drawing	Pins	SPQ	Length (mm)	Width (mm)	Height (mm)
ADS8341E/2K5	SSOP	DBQ	16	2500	367.0	367.0	35.0
ADS8341EB/2K5	SSOP	DBQ	16	2500	367.0	367.0	35.0

**GENERIC PACKAGE VIEW**

**DBQ 16**

**SSOP - 1.75 mm max height**

SHRINK SMALL-OUTLINE PACKAGE

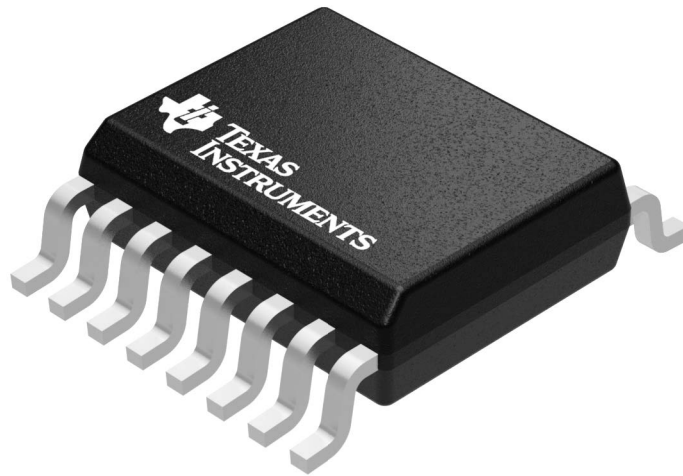

Images above are just a representation of the package family, actual package may vary.  
Refer to the product data sheet for package details.

4073301-2/1



# EXAMPLE BOARD LAYOUT

DBQ0016A

SSOP - 1.75 mm max height

SHRINK SMALL-OUTLINE PACKAGE

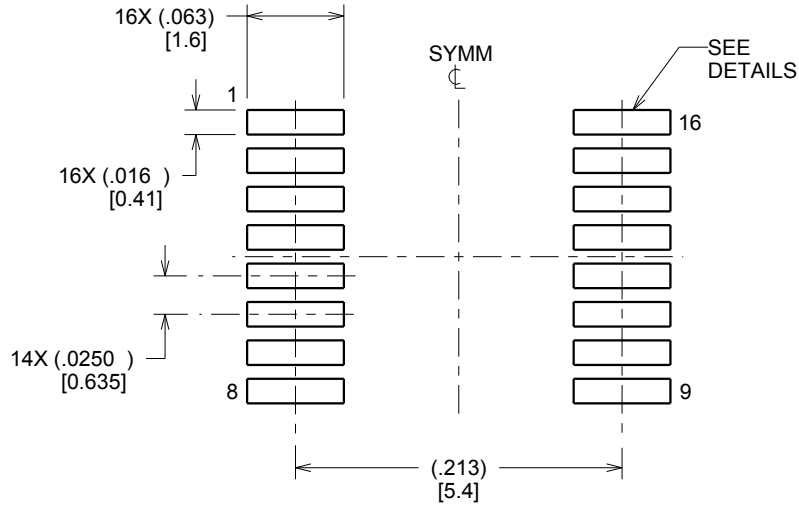

LAND PATTERN EXAMPLE  
SCALE:8X

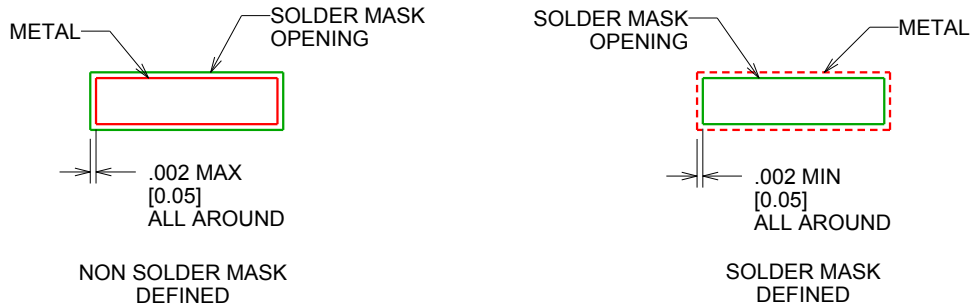

SOLDER MASK DETAILS

4214846/A 03/2014

NOTES: (continued)

- 6. Publication IPC-7351 may have alternate designs.
- 7. Solder mask tolerances between and around signal pads can vary based on board fabrication site.

# EXAMPLE STENCIL DESIGN

DBQ0016A

SSOP - 1.75 mm max height

SHRINK SMALL-OUTLINE PACKAGE

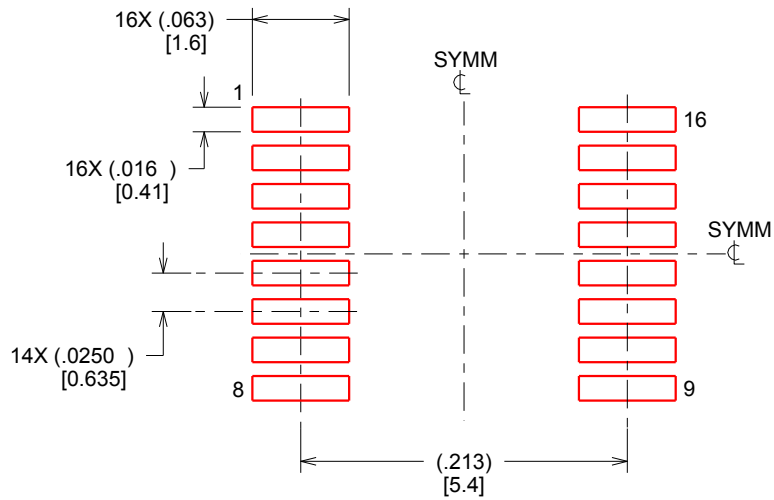

SOLDER PASTE EXAMPLE  
BASED ON .005 INCH [0.127 MM] THICK STENCIL  
SCALE:8X

4214846/A 03/2014

NOTES: (continued)

8. Laser cutting apertures with trapezoidal walls and rounded corners may offer better paste release. IPC-7525 may have alternate design recommendations.
9. Board assembly site may have different recommendations for stencil design.

## IMPORTANT NOTICE AND DISCLAIMER

TI PROVIDES TECHNICAL AND RELIABILITY DATA (INCLUDING DATASHEETS), DESIGN RESOURCES (INCLUDING REFERENCE DESIGNS), APPLICATION OR OTHER DESIGN ADVICE, WEB TOOLS, SAFETY INFORMATION, AND OTHER RESOURCES "AS IS" AND WITH ALL FAULTS, AND DISCLAIMS ALL WARRANTIES, EXPRESS AND IMPLIED, INCLUDING WITHOUT LIMITATION ANY IMPLIED WARRANTIES OF MERCHANTABILITY, FITNESS FOR A PARTICULAR PURPOSE OR NON-INFRINGEMENT OF THIRD PARTY INTELLECTUAL PROPERTY RIGHTS.

These resources are intended for skilled developers designing with TI products. You are solely responsible for (1) selecting the appropriate TI products for your application, (2) designing, validating and testing your application, and (3) ensuring your application meets applicable standards, and any other safety, security, or other requirements. These resources are subject to change without notice. TI grants you permission to use these resources only for development of an application that uses the TI products described in the resource. Other reproduction and display of these resources is prohibited. No license is granted to any other TI intellectual property right or to any third party intellectual property right. TI disclaims responsibility for, and you will fully indemnify TI and its representatives against, any claims, damages, costs, losses, and liabilities arising out of your use of these resources.

TI's products are provided subject to TI's Terms of Sale ([www.ti.com/legal/termsofsale.html](http://www.ti.com/legal/termsofsale.html)) or other applicable terms available either on [ti.com](http://ti.com) or provided in conjunction with such TI products. TI's provision of these resources does not expand or otherwise alter TI's applicable warranties or warranty disclaimers for TI products.

Mailing Address: Texas Instruments, Post Office Box 655303, Dallas, Texas 75265  
Copyright © 2019, Texas Instruments Incorporated

## Looking for pricing, stock, or lifecycle information?

Click below to explore more details on WIN SOURCE:

 [View ADS8341EB](#) on WIN SOURCE

 [Texas Instruments](#) Information

## Optimize Your Supply Chain with WIN SOURCE Solutions

-  Global Sourcing Solution
-  Obsolete Management
-  Cost Control Management
-  Shortage Management
-  Alternative Solution
-  Excess Inventory Management