



**THE DATASHEET OF
ADT7466ARQZ-REEL**





FEATURES

- Monitors two analog voltages or thermistor temperature inputs**
- One on-chip and up to two remote temperature sensors with series resistance cancellation**
- Controls and monitors the speed of up to two fans**
- Automatic fan speed control mode controls system cooling based on measured temperature**
- Enhanced acoustic mode dramatically reduces user perception of changing fan speeds**
- Thermal protection feature via THERM output monitors performance impact of Intel® Pentium® 4 processor thermal control circuit via PROCHOT input**
- 3-wire fan speed measurement**
- Limit comparison of all monitored values**
- SMBus 1.1 serial interface**

APPLICATIONS

Low acoustic noise notebook PCs

GENERAL DESCRIPTION

The ADT7466 dBCool controller is a complete thermal monitor and dual fan controller for noise-sensitive applications requiring active system cooling. It can monitor two analog voltages or the temperature of two thermistors, plus its own supply voltage. It can monitor the temperature of up to two remote sensor diodes, plus its own internal temperature. It can measure and control the speed of up to two fans so that they operate at the lowest possible speed for minimum acoustic noise. The automatic fan speed control loop optimizes fan speed for a given temperature. The effectiveness of the system's thermal solution can be monitored using the PROCHOT input to time and monitor the PROCHOT output of the processor.

FUNCTIONAL BLOCK DIAGRAM

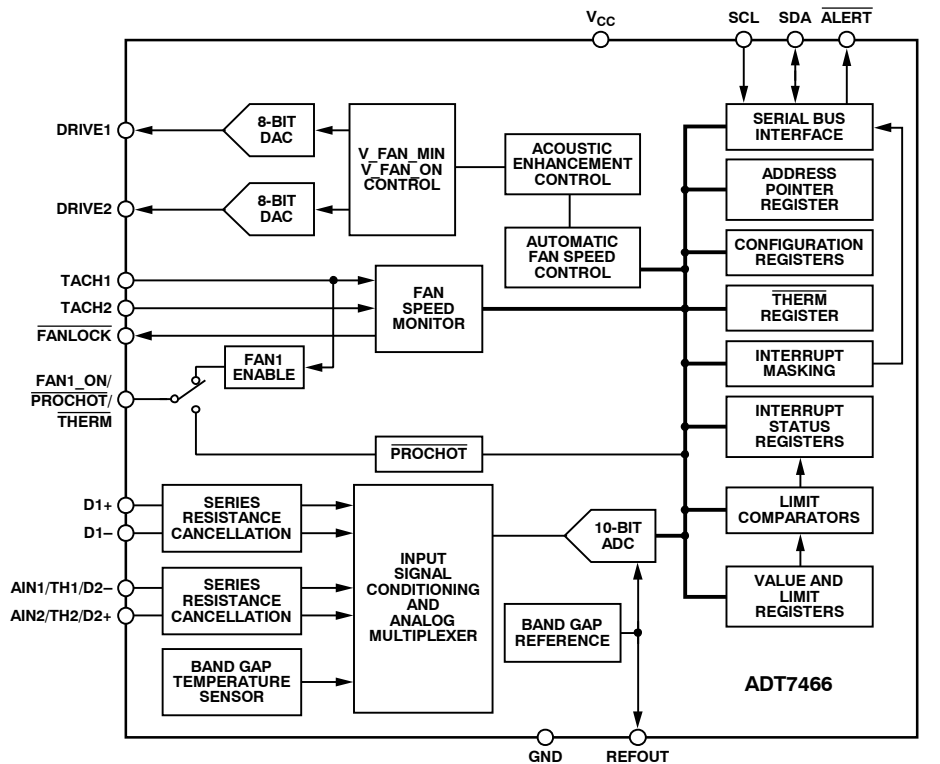

Figure 1.

Protected by U.S. Patent Numbers 6,188,189; 6,169,442; 6,097,239; 5,982,221; 5,867,012.

TABLE OF CONTENTS

| | | | |
|---|----|--|----|
| Specifications | 3 | Series Resistance Cancellation | 17 |
| Serial Bus Timing | 5 | Temperature Measurement Method..... | 17 |
| Absolute Maximum Ratings | 6 | Using Discrete Transistors | 17 |
| Thermal Characteristics..... | 6 | Temperature Measurement Using Thermistors..... | 19 |
| ESD Caution | 6 | Reading Temperature from the ADT7466 | 21 |
| Pin Configuration and Function Descriptions | 7 | Additional ADC Functions | 22 |
| Typical Performance Characteristics | 8 | Limit Values | 22 |
| Functional Description..... | 11 | Alert Interrupt Behavior | 23 |
| Measurement Inputs..... | 11 | Configuring the ADT7466 THERM Pin as an Output | 26 |
| Sequential Measurement..... | 11 | Fan Drive..... | 27 |
| Fan Speed Measurement and Control..... | 11 | PWM or Switch Mode Fan Drive | 27 |
| Internal Registers of the ADT7466..... | 11 | Fan Speed Measurement..... | 27 |
| Theory of Operation..... | 12 | Fan Start-Up Timeout | 29 |
| Serial Bus Interface | 12 | Automatic Fan Speed Control..... | 30 |
| Write and Read Operations | 14 | Starting the Fan | 31 |
| Alert Response Address (ARA) | 15 | XOR Test Mode | 32 |
| SMBus Timeout..... | 15 | Application Circuit | 33 |
| Voltage Measurement | 15 | ADT7466 Register Map..... | 34 |
| Reference Voltage Output | 16 | Register Details..... | 36 |
| Configuration of Pin 11 and Pin 12..... | 16 | Outline Dimensions..... | 48 |
| Temperature Measurement..... | 17 | Ordering Guide | 48 |

REVISION HISTORY

01/08—Rev 2: Correction to ON Semiconductor Logo

12/07—Rev 1: Conversion to ON Semiconductor

06/05—Revision 0: Initial Version

SPECIFICATIONS

$T_A = T_{MIN}$ to T_{MAX} , $V_{CC} = V_{MIN}$ to V_{MAX} , unless otherwise noted.¹

Table 1.

| Parameter | Min | Typ | Max | Unit | Test Conditions/Comments |
|---|-------|---------|-----------|--------------|---|
| POWER SUPPLY | | | | | |
| Supply Voltage | 3.0 | 3.3 | 5.5 | V | |
| Supply Current, I_{CC} | | 1.4 | 3 | mA | Interface inactive, ADC active |
| | | 30 | 70 | μ A | Standby mode, digital inputs low |
| TEMPERATURE-TO-DIGITAL CONVERTER | | | | | |
| Local Sensor Accuracy | | | ± 1 | $^{\circ}$ C | $20^{\circ}\text{C} \leq T_A \leq 60^{\circ}\text{C}$; $V_{CC} = 3.3\text{ V}$ |
| | | | ± 3 | $^{\circ}$ C | $-40^{\circ}\text{C} \leq T_A \leq +125^{\circ}\text{C}$; $V_{CC} = 3.3\text{ V}$ |
| Resolution | | 0.25 | | $^{\circ}$ C | |
| Remote Diode Sensor Accuracy | | | ± 1 | $^{\circ}$ C | $20^{\circ}\text{C} \leq T_A \leq 60^{\circ}\text{C}$; $-40^{\circ}\text{C} \leq T_D \leq +125^{\circ}\text{C}$; $V_{CC} = 3.3\text{ V}$ |
| | | | ± 3 | $^{\circ}$ C | $-40^{\circ}\text{C} \leq T_A \leq +105^{\circ}\text{C}$; $-40^{\circ}\text{C} \leq T_D \leq +125^{\circ}\text{C}$; $V_{CC} = 3.3\text{ V}$ |
| | | | ± 5 | $^{\circ}$ C | $-40^{\circ}\text{C} \leq T_A \leq +125^{\circ}\text{C}$; $-40^{\circ}\text{C} \leq T_D \leq +125^{\circ}\text{C}$ |
| Resolution | | 0.25 | | $^{\circ}$ C | |
| Remote Sensor Source Current | | 192 | | μ A | High level |
| | | 72 | | μ A | Mid level |
| | | 12 | | μ A | Low level |
| Series Resistance Cancellation | 0 | | 2 | k Ω | Maximum resistance in series with thermal diode that can be cancelled out |
| THERMISTOR-TO-DIGITAL CONVERTER | | | | | |
| Temperature Range | 30 | | 100 | $^{\circ}$ C | Range over which specified accuracy is achieved. Wider range can be used with less accuracy. |
| Resolution | | 0.25 | | $^{\circ}$ C | |
| Accuracy | | ± 2 | | $^{\circ}$ C | Using specified thermistor and application circuit over specified temperature range |
| ANALOG-TO-DIGITAL CONVERTER | | | | | |
| Input Voltage Range | 0 | | V_{REF} | V | $V_{REF} = 2.25\text{V}$ |
| Total Unadjusted Error (TUE) | | ± 1 | ± 2.5 | % | |
| Differential Nonlinearity (DNL) | | | ± 1 | LSB | |
| Power Supply Sensitivity | | ± 1 | | %/V | |
| Conversion Time (A_{IN} Input) | | 8.30 | 8.65 | ms | Averaging enabled |
| Conversion Time (Local Temperature) | | 8.63 | 8.99 | ms | Averaging enabled |
| Conversion Time (Remote Temperature) | | 35.22 | 36.69 | ms | Averaging enabled |
| Conversion Time (V_{CC}) | | 7.93 | 8.26 | ms | Averaging enabled |
| Total Monitoring Cycle Time | | 68.38 | 71.24 | ms | Averaging enabled, Pin 11 and Pin 12 configured for A_{IN}/TH monitoring (see Table 15) |
| Total Monitoring Cycle Time | | 87 | 90.63 | ms | Averaging enabled, Pin 11 and Pin 12 configured for $REM2$ monitoring (see Table 15) |
| FAN RPM-TO-DIGITAL CONVERTER | | | | | |
| Accuracy | | | ± 4 | % | |
| Full-Scale Count | | | 65,535 | | |
| Nominal Input RPM | | 109 | | RPM | Fan count = 0xBFFF |
| | | 329 | | RPM | Fan count = 0x3FFF |
| | | 5000 | | RPM | Fan count = 0x0438 |
| | | 10000 | | RPM | Fan count = 0x021C |
| Internal Clock Frequency | 78.64 | 81.92 | 85.12 | kHz | |

SERIAL BUS TIMING

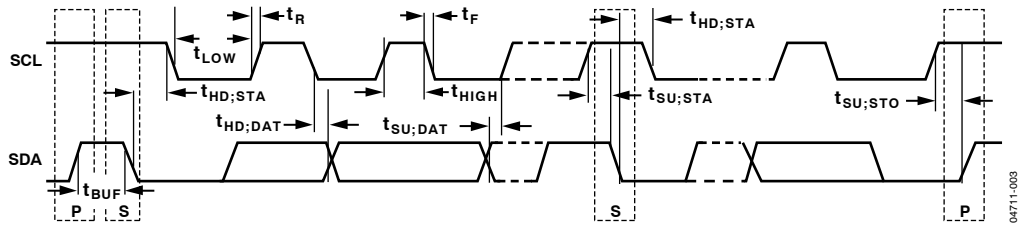

Figure 2. Diagram for Serial Bus Timing

04711-003

ABSOLUTE MAXIMUM RATINGS

Table 2.

| Parameter | Rating |
|---|-----------------|
| Positive Supply Voltage (V_{CC}) | 6.5 V |
| Voltage on Any Other Pin | -0.3 V to 6.5 V |
| Input Current at Any Pin | ± 5 mA |
| Package Input Current | ± 20 mA |
| Maximum Junction Temperature (T_J max) | 150°C |
| Storage Temperature Range | -65°C to +150°C |
| Lead Temperature, Soldering: | |
| IR Peak Reflow Temperature | 220°C |
| Lead Temperature (10 sec) | 300°C |
| ESD Rating | 2000 V |

Stresses greater than those listed under Absolute Maximum Ratings may cause permanent damage to the device. This is a stress rating only and functional operation of the device at these or any other conditions above those indicated in the operational section of this specification is not implied. Exposure to absolute maximum rating conditions for extended periods may affect device reliability.

THERMAL CHARACTERISTICS

16-Lead QSOP Package:

$$\theta_{JA} = 105^{\circ}\text{C}/\text{W}$$

$$\theta_{JC} = 39^{\circ}\text{C}/\text{W}$$

ESD CAUTION

ESD (electrostatic discharge) sensitive device. Electrostatic charges as high as 4000 V readily accumulate on the human body and test equipment and can discharge without detection. Although this product features proprietary ESD protection circuitry, permanent damage may occur on devices subjected to high energy electrostatic discharges. Therefore, proper ESD precautions are recommended to avoid performance degradation or loss of functionality.



PIN CONFIGURATION AND FUNCTION DESCRIPTIONS

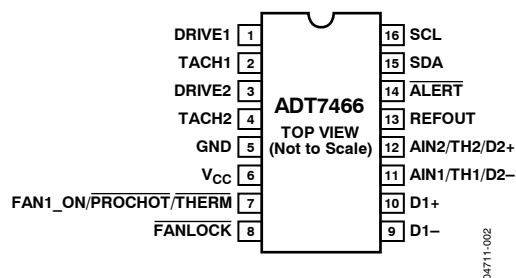

Figure 3. Pin Configuration

Table 3. Pin Function Descriptions

| Pin No. | Mnemonic | Type | Description |
|---------|--|----------------|---|
| 1 | DRIVE1 | Analog Output | Output of 8-Bit DAC Controlling Fan 1 Speed. |
| 2 | TACH1 | Digital Input | Fan Tachometer Input to Measure Speed of Fan 1. |
| 3 | DRIVE2 | Analog Output | Output of 8-Bit DAC Controlling Fan 2 Speed. |
| 4 | TACH2 | Digital Input | Fan Tachometer Input to Measure Speed of Fan 2. |
| 5 | GND | Ground | Ground Pin for Analog and Digital Circuitry. |
| 6 | V _{cc} | Power supply | 3.3 V Power Supply. V _{cc} is also monitored through this pin. |
| 7 | FAN1_ON/ $\overline{\text{PROCHOT}}$ / THERM | Digital I/O | If configured as FAN1_ON, this pin is the open-drain control signal output for the dc-dc converter. Active (high) when DRIVE1 > V_FAN_MIN. If configured as $\overline{\text{PROCHOT}}$, the input can be connected to the $\overline{\text{PROCHOT}}$ output of the Intel Pentium 4 processor to time and monitor $\overline{\text{PROCHOT}}$ assertions. If configured as THERM, this pin is the interrupt output to flag critical thermal events. |
| 8 | $\overline{\text{FANLOCK}}$ | Digital Output | Open-Drain Digital Output. This output is asserted (low) when either of the fans stall or fail to spin up. |
| 9 | D1- | Analog Input | Cathode Connection to Thermal Diode 1. |
| 10 | D1+ | Analog Input | Anode Connection to Thermal Diode 1. |
| 11 | AIN1/TH1/D2- | Analog input | 0 V to 2.25 V Analog Input. Can be reconfigured as thermistor input or as a cathode connection to Thermal Diode 2. Configured for thermistor connection by default. |
| 12 | AIN2(TH2)/D2+ | Analog Input | 0 V to 2.25 V Analog Input. Can be reconfigured as thermistor input or as an anode connection to Thermal Diode 2. Configured for thermistor connection by default. |
| 13 | REFOUT | Analog Output | 2.25 V Reference Voltage Output, 20 mA maximum output current. |
| 14 | $\overline{\text{ALERT}}$ | Digital Output | Open-Drain Digital Output. The SMBus $\overline{\text{ALERT}}$ pin alerts the system to out-of-limit events such as a failed fan, overtemperature, or out-of-limit analog measurement. |
| 15 | SDA | Digital I/O | Open-Drain Digital I/O. SMBus bidirectional serial data. Requires SMBus pull-up resistor. |
| 16 | SCL | Digital Input | Open-Drain Digital Input. SMBus serial clock input. Requires SMBus pull-up resistor. |

TYPICAL PERFORMANCE CHARACTERISTICS

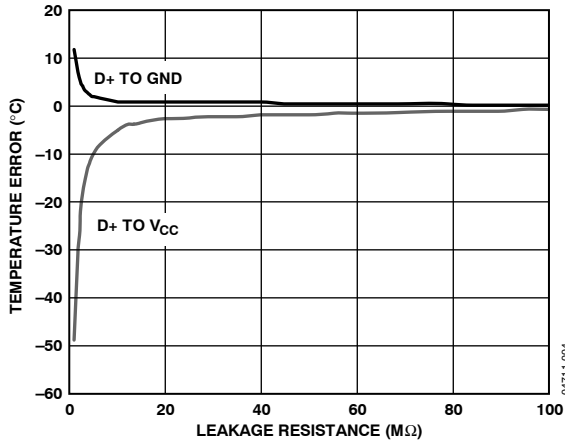

Figure 4. Temperature Error vs. PCB Track Resistance

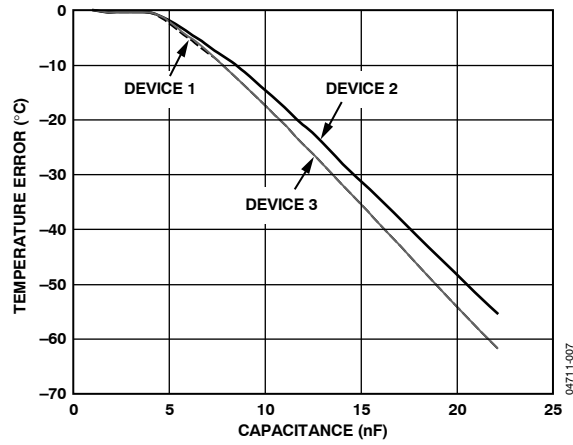

Figure 7. Temperature Error vs. Capacitance Between D+ and D-

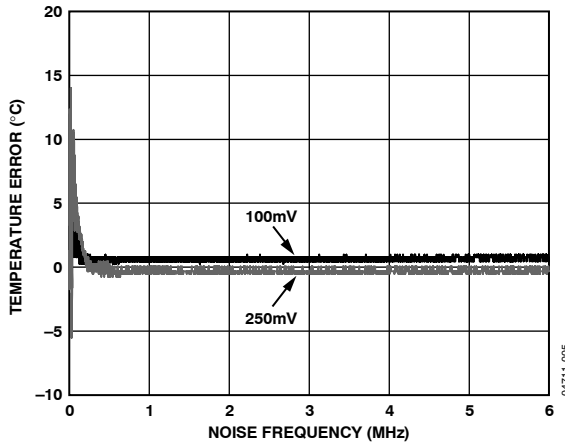

Figure 5. Remote Temperature Error vs. Power Supply Noise Frequency

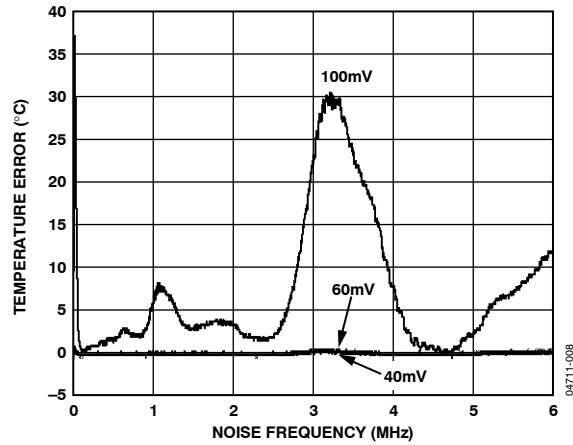

Figure 8. Remote Temperature Error vs. Common-Mode Noise Frequency

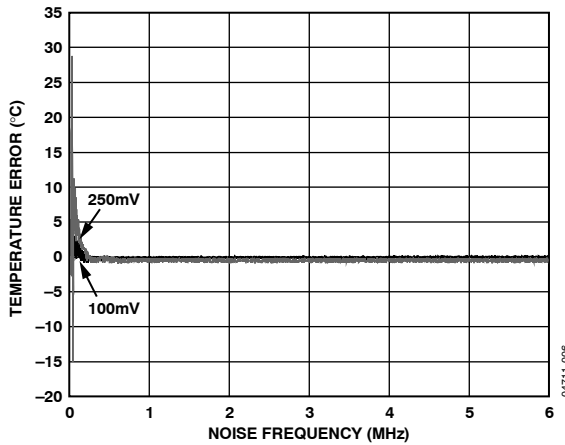

Figure 6. Local Temperature Error vs. Power Supply Noise Frequency

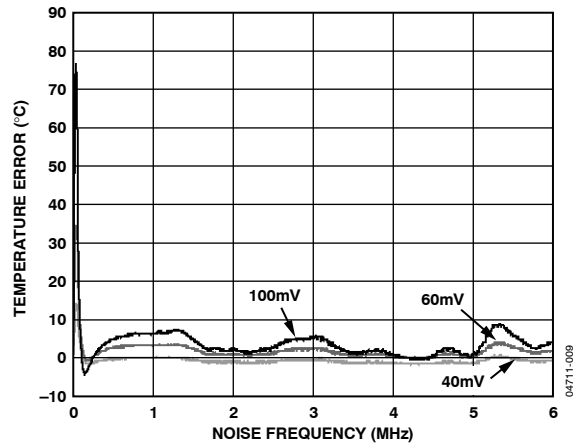

Figure 9. Remote Temperature Error vs. Differential Mode Noise Frequency

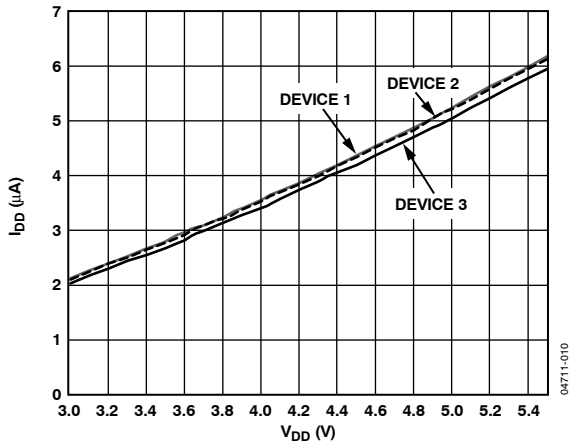

Figure 10. Standby Supply Current vs. Supply Voltage

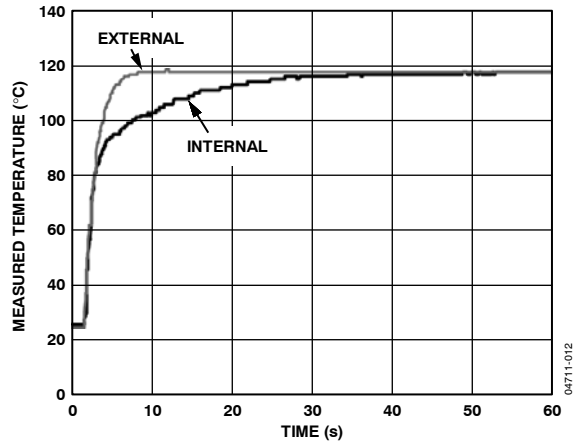

Figure 13. Response to Thermal Shock

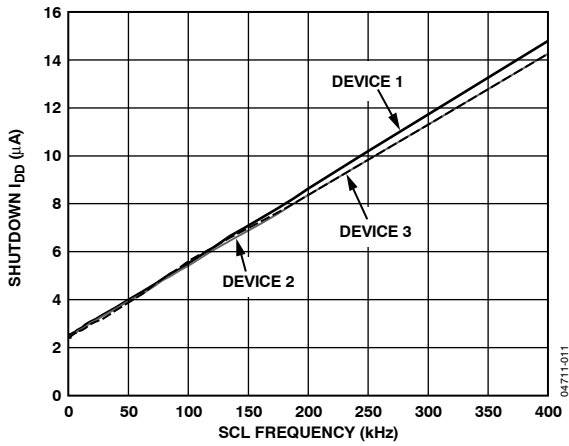

Figure 11. Standby Current vs. Clock Frequency

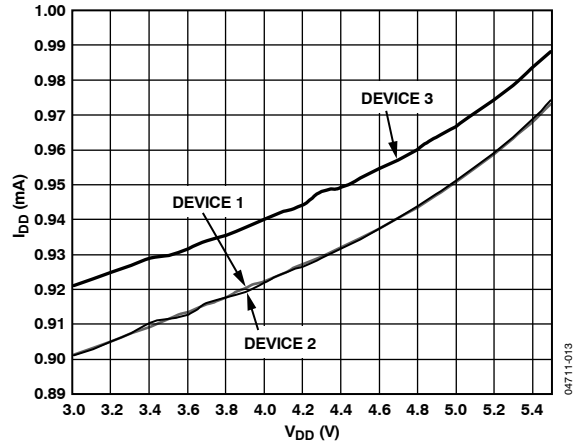

Figure 14. Supply Current vs. Supply Voltage

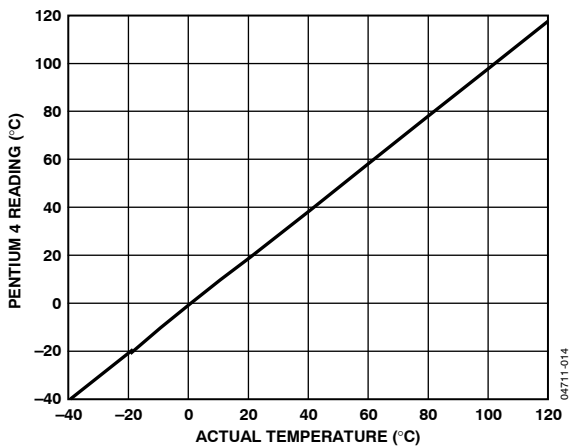

Figure 12. Pentium 4 Temperature Measurement vs. ADT7466 Reading

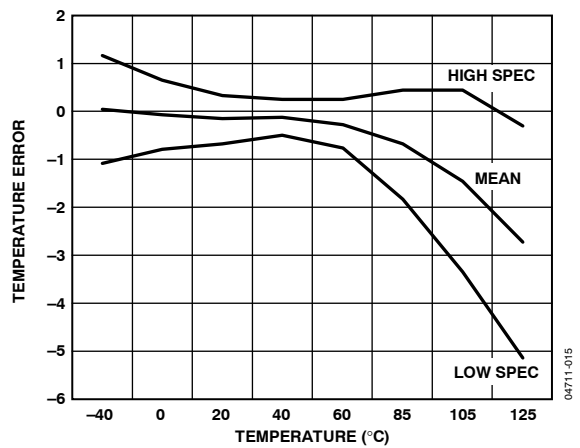

Figure 15. Local Temperature Error

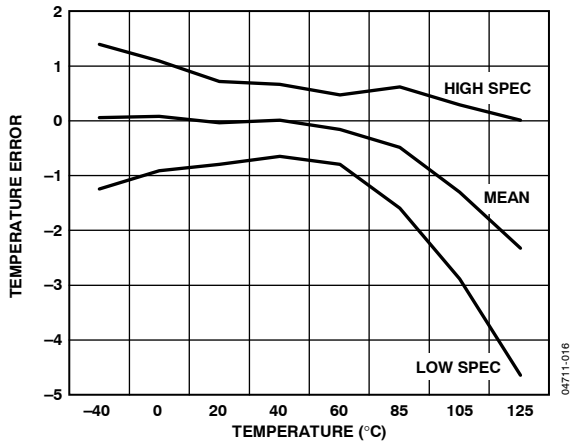

Figure 16. Remote Temperature Error

FUNCTIONAL DESCRIPTION

The ADT7466 is a complete thermal monitor and dual fan controller for any system requiring monitoring and cooling. The device communicates with the system via a serial system management bus (SMBus). The serial data line (SDA, Pin 15) is used for reading and writing addresses and data. The input line, (SCL, Pin 16) is the serial clock. All control and programming functions of the ADT7466 are performed over the serial bus. In addition, an ALERT output is provided to indicate out-of-limit conditions.

MEASUREMENT INPUTS

The device has three measurement inputs, two for voltage and one for temperature. It can also measure its own supply voltage and can measure ambient temperature with its on-chip temperature sensor.

Pin 11 and Pin 12 are analog inputs with an input range of 0 V to 2.25 V. They can easily be scaled for other input ranges by using external attenuators. These pins can also be configured for temperature monitoring by using thermistors or a second remote diode temperature measurement.

The ADT7466 can simultaneously monitor the local temperature, the remote temperature by using a discrete transistor, and two thermistor temperatures.

Remote temperature sensing is provided by the D+ and D- inputs, to which diode connected, remote temperature sensing transistors such as a 2N3904 or CPU thermal diode can be connected.

Temperature sensing using thermistors is carried out by placing the thermistor in series with a resistor. The excitation voltage is provided by the REFOUT pin.

The device also accepts input from an on-chip band gap temperature sensor that monitors system ambient temperature.

Power is supplied to the chip via Pin 6. The system also monitors V_{CC} through this pin. It is normally connected to a 3.3 V supply. It can, however, be connected to a 5 V supply and monitored without going over range.

SEQUENTIAL MEASUREMENT

When the ADT7466 monitoring sequence is started, it sequentially cycles through the measurement of analog inputs and the temperature sensors. Measured values from these inputs are stored in value registers, which can be read out over the serial bus, or can be compared with programmed limits stored in the limit registers. The results of out of limit comparisons are stored in the status registers, which can be read over the serial bus to flag out-of-limit conditions.

FAN SPEED MEASUREMENT AND CONTROL

The ADT7466 has two tachometer inputs for measuring the speed of 3-wire fans, and it has two 8-bit DACs to control the speed of two fans. The temperature measurement and fan speed control can be linked in an automatic control loop, which can operate without CPU intervention to maintain system operating temperature within acceptable limits. The enhanced acoustics feature ensures that fans operate at the minimum possible speed consistent with temperature control, and change speed gradually. This reduces the user's perception of changing fan speed.

INTERNAL REGISTERS OF THE ADT7466

Table 4 provides brief descriptions of the ADT7466's principal internal registers. More detailed information on the function of each register is given in Table 30 to Table 72.

Table 4. Internal Register Summary

| Register | Description |
|-------------------|---|
| Configuration | These registers provide control and configuration of the ADT7466 including alternate pinout functionality. |
| Address Pointer | This register contains the address that selects one of the other internal registers. When writing to the ADT7466, the first byte of data is always a register address, which is written to the address pointer register. |
| Status | These registers provide status of each limit comparison and are used to signal <u>out-of-limit</u> conditions on the temperature, voltage, or fan speed channels. Whenever a status bit is set, the ALERT output (Pin 14) goes low. |
| Interrupt Mask | These registers allow interrupt sources to be masked so that they do not affect the ALERT output. |
| Value and Limit | The results of analog voltage inputs, temperature, and fan speed measurements are stored in these registers, along with their limit values. |
| Offset | These registers allow each temperature channel reading to be offset by a twos complement value written to these registers. |
| PROCHOT Status | This register allows the ADT7466 to monitor and time any PROCHOT events gauging system performance. |
| T_{MIN} | These registers program the starting temperature for each fan under automatic fan speed control. |
| T_{RANGE} | These registers program the temperature-to-fan speed control slope in automatic fan speed control mode for each fan drive output. |
| Enhance Acoustics | This register sets the step size for fan drive changes in AFC mode to minimize acoustic noise. |

THEORY OF OPERATION

SERIAL BUS INTERFACE

The serial system management bus (SMBus) is used to control the ADT7466. The ADT7466 is connected to this bus as a slave device under the control of a master controller.

The ADT7466 has an SMBus timeout feature. When this is enabled, the SMBus times out after typically 25 ms of no activity. However, this feature is enabled by default. Bit 5 of Configuration Register 1 (0x00) should be set to 1 to disable this feature.

The ADT7466 supports optional packet error checking (PEC). It is triggered by supplying the extra clock pulses for the PEC byte. The PEC byte is calculated using CRC-8. The frame check sequence (FCS) conforms to CRC-8 by the polynomial

$$C(x) = x^8 + x^2 + x + 1$$

Consult the SMBus Specifications Rev. 1.1 for more information (www.smbus.org).

The ADT7466 has a 7-bit serial bus address, which is fixed at 1001100.

The serial bus protocol operates as follows:

The master initiates data transfer by establishing a start condition, defined as a high-to-low transition on the serial data line SDA while the serial clock line SCL remains high. This indicates that an address/data stream follows. All slave peripherals connected to the serial bus respond to the start condition, and shift in the next 8 bits, consisting of a 7-bit address (MSB first) and a $\overline{R/W}$ bit, which determines the direction of the data transfer, that is, whether data is written to or read from the slave device.

The address of the ADT7466 is set at 1001100. Since the address must always be followed by a write bit (0) or a read bit (1), and data is generally handled in 8-bit bytes, it may be more convenient to think that the ADT7466 has an 8-bit write address of 10011000 (0x98) and an 8-bit read address of 10011001 (0x99). The peripheral whose address corresponds to the transmitted address responds by pulling the data line low during the low period before the 9th clock pulse, known as the acknowledge bit. All other devices on the bus now remain idle while the selected device waits for data to be read from or written to it. If the $\overline{R/W}$ bit is 0, the master writes to the slave device. If the $\overline{R/W}$ bit is 1, the master reads from the slave device.

Data is sent over the serial bus in sequences of 9 clock pulses, 8 bits of data followed by an acknowledge bit from the slave device. Transitions on the data line must occur during the low period of the clock signal and remain stable during the high period, because a low-to-high transition when the clock is high

may be interpreted as a stop signal. The number of data bytes that can be transmitted over the serial bus in a single read or write operation is limited only by what the master and slave devices can handle.

When all data bytes have been read or written, stop conditions are established. In write mode, the master pulls the data line high during the 10th clock pulse to assert a stop condition. In read mode, the master device overrides the acknowledge bit by pulling the data line high during the low period before the ninth clock pulse. This is known as No Acknowledge. The master takes the data line low during the low period before the 10th clock pulse, and then high during the 10th clock pulse to assert a stop condition.

Any number of bytes of data can be transferred over the serial bus in one operation, but it is not possible to mix read and write in one operation, because the type of operation is determined at the beginning and subsequently cannot be changed without starting a new operation.

ADT7466 write operations contain either one or two bytes, and read operations contain one byte, and perform the following functions.

To write data to one of the device data registers or read data from it, the address pointer register must be set so that the correct data register is addressed, and data can be written to that register or read from it. The first byte of a write operation always contains an address that is stored in the address pointer register. If data is to be written to the device, the write operation contains a second data byte that is written to the register selected by the address pointer register. This is shown in Figure 17. The device address is sent over the bus followed by $\overline{R/W}$ set to 0. This is followed by two data bytes. The first data byte is the address of the internal data register to be written to, which is stored in the address pointer register. The second data byte is the data to be written to the internal data register.

When reading data from a register, there are two possibilities.

If the ADT7466 address pointer register value is unknown or not the desired value, it is necessary to first set it to the correct value before data can be read from the desired data register. This is done by performing a write to the ADT7466 as before, but only the data byte containing the register address is sent since data is not to be written to the register. This is shown in Figure 18.

A read operation is then performed consisting of the serial bus address, $\overline{R/W}$ bit set to 1, followed by the data byte read from the data register. This is shown in Figure 19.

If the address pointer register is known to already be at the desired address, data can be read from the corresponding data register without first writing to the address pointer register, so the procedure in Figure 18 can be omitted.

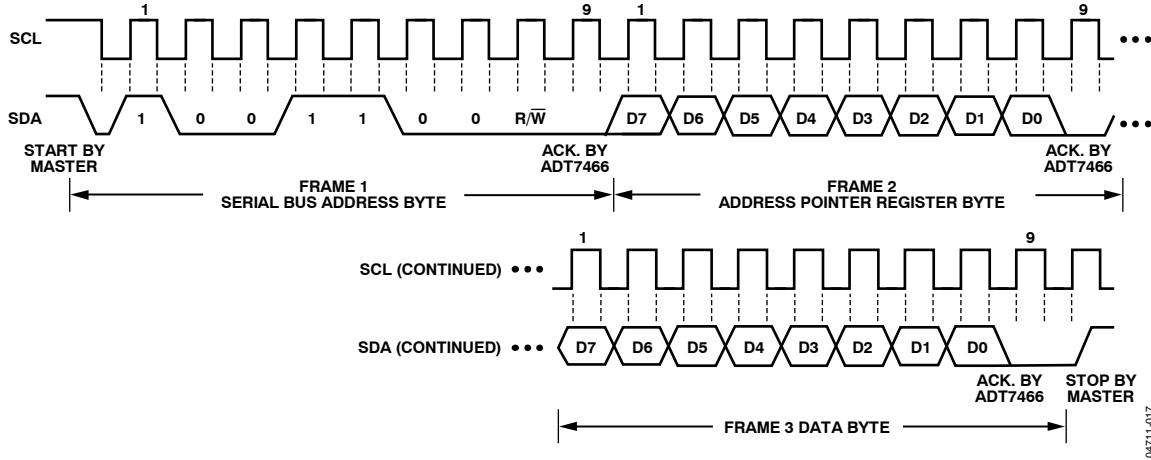

Figure 17. Writing a Register Address to the Address Pointer Register, then Writing Data to the Selected Register

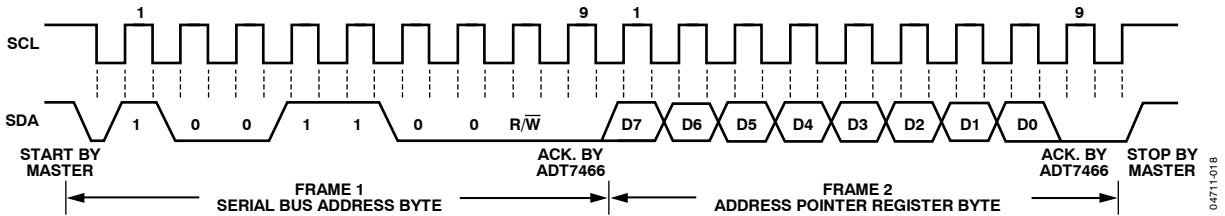

Figure 18. Writing to the Address Pointer Register Only

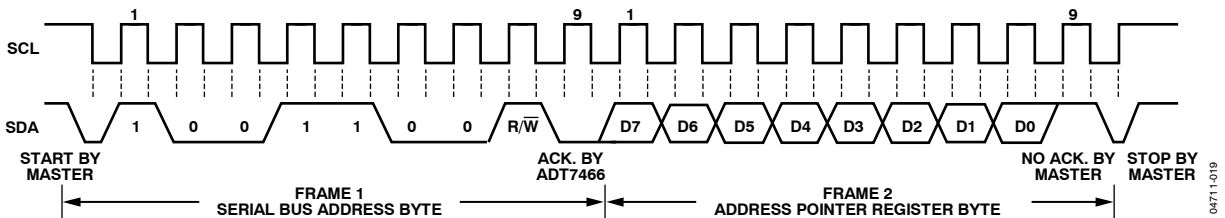

Figure 19. Reading Data from a Previously Selected Register

Although it is possible to *read* a data byte from a data register without first writing to the address pointer register if the address pointer register is already at the correct value, it is not possible to *write* data to a register without writing to the address pointer register, because the first data byte of a write is always written to the address pointer register.

In addition to supporting the send byte and receive byte protocols, the ADT7466 also supports the read byte protocol (see the SMBus Specifications Rev. 1.1 for more information).

If it is required to perform several read or write operations in succession, the master can send a repeat start condition instead of a stop condition to begin a new operation.

WRITE AND READ OPERATIONS

The SMBus specification defines several protocols for different types of write and read operations. The protocols used in the ADT7466 are discussed in the following sections. The following abbreviations are used in the diagrams:

- S—Start
- P—Stop
- R—Read
- W—Write
- A—Acknowledge
- \bar{A} —No Acknowledge

Write Operations

The ADT7466 uses the send byte and write byte protocols.

Send Byte

In this operation, the master device sends a single command byte to a slave device, as follows:

1. The master device asserts a start condition on SDA.
2. The master sends the 7-bit slave address followed by the write bit (low).
3. The addressed slave device asserts ACK on SDA.
4. The master sends a register address.
5. The slave asserts ACK on SDA.
6. The master asserts a stop condition on SDA and the transaction ends.

For the ADT7466, the send byte protocol is used to write a register address to RAM for a subsequent single-byte read from the same address. This is shown in Figure 20.

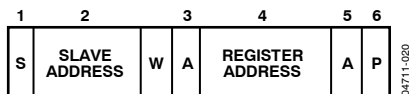

Figure 20. Setting a Register Address for Subsequent Read

If it is required to read data from the register immediately after setting up the address, the master can assert a repeat start condition immediately after the final ACK and carry out a single-byte read without asserting an intermediate stop condition.

Write Byte

In this operation, the master device sends a command byte and one data byte to the slave device, as follows:

1. The master device asserts a start condition on SDA.
2. The master sends the 7-bit slave address followed by the write bit (low).

3. The addressed slave device asserts ACK on SDA.
4. The master sends a register address.
5. The slave asserts ACK on SDA.
6. The master sends a data byte.
7. The slave asserts ACK on SDA.
8. The master asserts a stop condition on SDA to end the transaction.

This is shown in Figure 21.

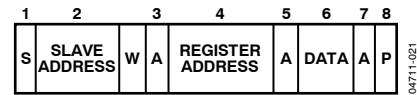

Figure 21. Single-Byte Write to a Register

Read Operations

The ADT7466 uses the following SMBus read protocols.

Receive Byte

This is useful when repeatedly reading a single register. The register address needs to have been set up previously.

In this operation, the master device receives a single byte from a slave device, as follows:

1. The master device asserts a start condition on SDA.
2. The master sends the 7-bit slave address followed by the read bit (high).
3. The addressed slave device asserts ACK on SDA.
4. The master receives a data byte.
5. The master asserts NO ACK on SDA.
6. The master asserts a stop condition on SDA and the transaction ends.

For the ADT7466, the receive byte protocol is used to read a single byte of data from a register whose address was set previously by a send byte or write byte operation.

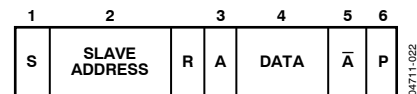

Figure 22. Single-Byte Read from a Register

ALERT RESPONSE ADDRESS (ARA)

ARA is a feature of SMBus devices that allows an interrupting device to identify itself to the host when multiple devices exist on the same bus. The ALERT output can be used as an interrupt output, or it can be used as an ALERT. One or more outputs can be connected to a common ALERT line connected to the master. If a device's ALERT line goes low, the following occurs:

1. ALERT is pulled low.
2. The master initiates a read operation and sends the alert response address (ARA = 0001 100). This is a general call address, which must not be used as a specific device address.
3. The device whose ALERT output is low responds to the alert response address, and the master reads its device address. The address of the device is now known, and it can be interrogated in the usual way.
4. If more than one device's ALERT output is low, the one with the lowest device address has priority, in accordance with normal SMBus arbitration.
5. Once the ADT7466 responds to the alert response address, the master must read the status registers, the ALERT is cleared only if the error condition no longer exists.

SMBus TIMEOUT

The ADT7466 includes an SMBus timeout feature. If there is no SMBus activity for 25 ms, the ADT7466 assumes that the bus is locked, and it releases the bus. This prevents the device from locking or holding the SMBus expecting data. Some SMBus controllers cannot handle the SMBus timeout feature, so they are disabled.

Table 5. Configuration Register 1—Register 0x00

| Bit Address and Value | Description |
|-----------------------|---------------------------------|
| <5> TODIS = 0 | SMBus timeout enabled (default) |
| <5> TODIS = 1 | SMBus timeout disabled |

VOLTAGE MEASUREMENT

The ADT7466 has two external voltage measurement channels. Pin 11 and Pin 12 are analog inputs with a range of 0 V to 2.25 V. It can also measure its own supply voltage, V_{CC} . The V_{CC} supply voltage measurement is carried out through the V_{CC} pin (Pin 6). Setting Bit 6 of Configuration Register 1 (0x00) allows a 5 V supply to power the ADT7466 and be measured without overranging the V_{CC} measurement channel.

A/D Converter

All analog inputs are multiplexed into the on-chip, successive approximation, analog-to-digital converter. This has a resolution

of 10 bits. The basic input range is 0 V to 2.25 V, but the V_{CC} input has built in attenuators to allow measurement of 3.3 V or 5 V. To allow for the tolerance of the supply voltage, the ADC produces an output of 3/4 full scale (decimal 768 or 0x300) for the nominal supply voltage, and so has adequate headroom to cope with overvoltages.

Table 9 shows the input ranges of the analog inputs and the output codes of the ADC.

Table 6. Voltage Measurement Registers

| Register | Description | Default |
|----------|------------------|---------|
| 0x0A | AIN1 reading | 0x00 |
| 0x0B | AIN2 reading | 0x00 |
| 0x0C | V_{CC} reading | 0x00 |

Associated with each voltage measurement channel are high and low limit registers. Exceeding the programmed high or low limit causes the appropriate status bit to be set. Exceeding either limit can also generate ALERT interrupts.

Table 7. Voltage Measurement Limit Registers

| Register | Description | Default |
|----------|---------------------|---------|
| 0x14 | AIN1 low limit | 0x00 |
| 0x15 | AIN1 high limit | 0xFF |
| 0x16 | AIN2 low limit | 0x00 |
| 0x17 | AIN2 high limit | 0xFF |
| 0x18 | V_{CC} low limit | 0x00 |
| 0x19 | V_{CC} high limit | 0xFF |

When the ADC is running, it samples and converts a voltage input in 1 ms, and averages 16 conversions to reduce noise. Therefore a measurement on each input takes nominally 16 ms.

Turn Off Averaging

For each voltage measurement read from a value register, 16 readings have actually been made internally and the results averaged, before being placed into the value register. There can be an instance where faster conversions are required. Setting Bit 4 of Configuration Register 2 (0x01) turns averaging off. This effectively gives a reading 16 times faster (1 ms), but as a result the reading can be noisier.

Single-Channel ADC Conversions

Setting Bit 3 of Configuration Register 4 (0x03) places the ADT7466 into single-channel ADC conversion mode. In this mode, the ADT7466 can be made to read a single voltage channel only. If the internal ADT7466 clock is used, the selected input is read every 1 ms. The appropriate ADC channel is selected by writing to Bits 2:0 of Configuration Register 4 (0x03).

ADT7466

Table 8. Single-Channel ADC Conversions

| Bits 2:0, Reg. 0x03 | Channel Selected |
|---------------------|------------------|
| 000 | AIN1 |
| 001 | AIN2 |
| 010 | V _{CC} |

REFERENCE VOLTAGE OUTPUT

The ADT7466 has a reference voltage of 2.25 V, which is available on Pin 13 of the device. It can be used for scaling and offsetting the analog inputs to give different voltage ranges. It can also be used as an excitation voltage for a thermistor when the analog inputs are configured as thermistor inputs. See the Temperature Measurement section for more details.

CONFIGURATION OF PIN 11 AND PIN 12

Pin 11 and Pin 12 can be used for analog inputs, thermistor inputs, or connecting a second remote thermal diode. The

ADT7466 is configured for thermistor connection by default. The device is configured for the different modes by setting the appropriate bits in the configuration registers. Bits 6:7 of Configuration Register 3 (0x02) configure the device for either analog inputs or thermistor inputs. Bit 7 of Configuration Register 2 (0x01) configures Pin 11 and Pin 12 for the connection of a second thermal diode. Bits 2:3 of Interrupt Status Register 2 (0x11) indicate either an open or short circuit on Thermal Diode 1 and Diode 2 inputs. Bits 4:5 of Interrupt Status Register 2 (0x11) indicate either an open or short circuit on TH1 and TH2 inputs. It is advisable to mask interrupts on diode open/short alerts when in thermistor monitoring mode and to mask interrupts on thermistor open/short alerts when in REM2 mode.

Table 9. A-to-D Output Code vs. V_{IN}

| V _{CC} 3.3 V | V _{CC} 5 V | A _{IN} | Decimal | Binary |
|-----------------------|---------------------|--------------------|----------------------|-----------------|
| <0.0172 | <0.026 | <0.0088 | 0 | 00000000 |
| 0.017–0.034 | 0.026–0.052 | 0.0088–0.0176 | 1 | 00000001 |
| 0.034–0.052 | 0.052–0.078 | 0.0176–0.0264 | 2 | 00000010 |
| 0.052–0.069 | 0.078–0.104 | 0.0264–0.0352 | 3 | 00000011 |
| 1.110–1.127 | 1.667–1.693 | 0.563–0.572 | 64 (¼ scale) | 01000000 |
| 2.220–2.237 | 3.333–3.359 | 1.126–1.135 | 128 (½ scale) | 10000000 |
| 3.3–3.347 | 5–5.026 | 1.689–1.698 | 192 (¾ scale) | 11000000 |
| 4.371–4.388 | 6.563–6.589 | 2.218–2.226 | 252 | 11111100 |
| 4.388–4.405 | 6.589–6.615 | 2.226–2.235 | 253 | 11111101 |
| 4.405–4.423 | 6.615–6.641 | 2.235–2.244 | 254 | 11111110 |
| >4.423 | >6.634 | >2.244 | 255 | 11111111 |

Table 10. Mode Configuration Summary

| Mode | Configuration Register Settings | Limits | Alerts ¹ | Description |
|---------------------|---------------------------------|---------------------------------|---|--|
| Thermistor Mode | | | | Default mode. Mask interrupts on diode NC. (Set Bits 2:3 of Reg. 0x13.) |
| TH1 | Register 0x02 Bit 7 = 1 | Low: Reg 0x14 High: Reg 0x15 | OOL: Reg. 0x10, Bit 6 NC: Reg. 0x11, Bit 4 | |
| TH2 | Register 0x02 Bit 6 = 1 | Low: Reg 0x16 High: Reg 0x17 | OOL: Reg. 0x10, Bit 5 NC: Reg. 0x11, Bit 5 | |
| AIN Mode | | | | Ensure that AFC is not on. (Clear Bits 0:1 of AFC Configuration Register 1, 0x05.) |
| AIN1 | Register 0x02 Bit 7 = 0 | Low: Reg 0x14 High: Reg 0x15 | OOL: Reg. 0x10, Bit 6 | |
| AIN2 | Register 0x02 Bit 6 = 0 | Low: Reg 0x16 High: Reg 0x17 | OOL: Reg. 0x10, Bit 5 | |
| Remote 2 Diode Mode | Register 0x01 Bit 7 = 1 | Low: Reg 0x14 High: Reg 0x15 | OOL: Reg. 0x10, Bit 6 NC: Reg. 0x11, Bit 3 | Mask interrupts on thermistor NC. (Set Bits 4:5 of Reg. 0x13) and AIN2 (Bit 5 of Reg. 0x12.) |

¹ OOL = Out of limit. NC = No connection.

TEMPERATURE MEASUREMENT

The ADT7466 has two dedicated temperature measurement channels, one for measuring the temperature of an on-chip band gap temperature sensor, and one for measuring the temperature of a remote diode, usually located in the CPU. In addition, the analog input channels, AIN1 and AIN2, can be reconfigured to measure the temperature of a second diode by setting Bit 7 of Configuration Register 2 (0x01), or to measure temperature using thermistors by setting Bit 6 and/or Bit 7 of Configuration Register 3 (0x02).

SERIES RESISTANCE CANCELLATION

Parasitic resistance, seen in series with the remote diode between the D+ and D- inputs to the ADT7466, is caused by a variety of factors including PCB track resistance and track length. This series resistance appears as a temperature offset in the sensor's temperature measurement. This error typically causes a 1°C offset per ohm of parasitic resistance in series with the remote diode. The ADT7466 automatically cancels the effect of this series resistance on the temperature reading, giving a more accurate result without the need for user characterization of the resistance. The ADT7466 is designed to automatically cancel typically 2 kΩ of resistance. This is done transparently to the user, using an advanced temperature measurement method described in the following section.

TEMPERATURE MEASUREMENT METHOD

A simple method of measuring temperature is to exploit the negative temperature coefficient of a diode, by measuring the base emitter voltage (V_{BE}) of a transistor operated at constant current. Unfortunately, this technique requires calibration to null out the effect of the absolute value of V_{BE} , which varies from device to device.

The technique used in the ADT7466 measures the change in V_{BE} when the device is operated at three different currents. Previous devices used only two operating currents, but it is the third current that allows series resistance cancellation.

Figure 24 shows the input signal conditioning used to measure the output of a remote temperature sensor. This figure shows the remote sensor as a substrate transistor, provided for temperature monitoring on some microprocessors, but it could also be a discrete transistor. If a discrete transistor is used, the

collector is not grounded, and should be linked to the base. To prevent ground noise from interfering with the measurement, the more negative terminal of the sensor is not referenced to ground but is biased above ground by an internal diode at the D- input. If the sensor is operating in an extremely noisy environment, C1 may optionally be added as a noise filter. Its value should never exceed 1000 pF. See the Layout Considerations section for more information on C1.

To measure ΔV_{BE} , the operating current through the sensor is switched between three related currents. Figure 24 shows $N1 \times I$ and $N2 \times I$ as different multiples of the current I . The currents through the temperature diode are switched between I and $N1 \times I$, giving ΔV_{BE1} , and then between I and $N2 \times I$, giving ΔV_{BE2} . The temperature can then be calculated using the two ΔV_{BE} measurements. This method can also cancel the effect of series resistance on the temperature measurement. The resulting ΔV_{BE} waveforms are passed through a 65 kHz low-pass filter to remove noise, and then to a chopper-stabilized amplifier. This amplifies and rectifies the waveform to produce a dc voltage proportional to ΔV_{BE} . The ADC digitizes this voltage, and a temperature measurement is produced. To reduce the effects of noise, digital filtering is performed by averaging the results of 16 measurement cycles for low conversion rates. Signal conditioning and measurement of the internal temperature sensor is performed in the same manner.

USING DISCRETE TRANSISTORS

If a discrete transistor is used, the collector is not grounded and should be linked to the base. If an NPN transistor is used, the emitter is connected to the D- input and the base to the D+ input. If a PNP transistor is used, the base is connected to the D- input and the emitter to the D+ input. Figure 23 shows how to connect the ADT7466 to an NPN or PNP transistor for temperature measurement. To prevent ground noise interfering with the measurement, the more negative terminal of the sensor is not referenced to ground, but is biased above ground by an internal diode at the D- input.

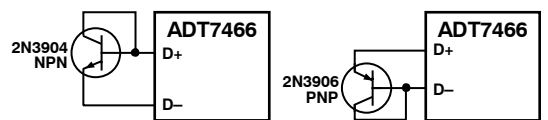

Figure 23. Connections for NPN and PNP Transistors

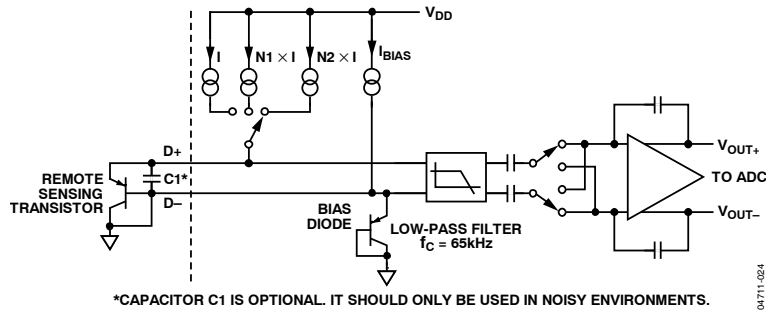

Figure 24. Signal Conditioning for Remote Diode Temperature Sensors

Temperature Data Format

The temperature data stored in the temperature data registers consists of a high byte with an LSB size equal to 1°C. If higher resolution is required, two additional bits are stored in the extended temperature registers, giving a resolution of 0.25°C. The temperature measurement range for both local and remote measurements is, by default, 0°C to 127°C (binary), so the ADC output code equals the temperature in degrees Celsius, and half the range of the ADC is not actually used.

The ADT7466 can also be operated by using an extended temperature range from -64°C to +191°C. In this case, the whole range of the ADC is used, but the ADC code is offset by +64°C, so it does not correspond directly to the temperature. (0°C = 0100000) .

The user can switch between these two temperature ranges by setting or clearing Bit 7 in Configuration Register 1. The measurement range should be switched only once after power-up, and the user should wait for two monitoring cycles (approximately 68 ms) before expecting a valid result. Both ranges have different data formats, as shown in Table 11.

Table 11. Temperature Data Format

| Temperature | Binary ¹ | Offset Binary ² |
|-------------|---------------------|----------------------------|
| -64°C | 0 000 0000 | 0 000 0000 |
| 0°C | 0 000 0000 | 0 100 0000 |
| 1°C | 0 000 0001 | 0 100 0001 |
| 10°C | 0 000 1010 | 0 100 1010 |
| 25°C | 0 001 1001 | 0 101 1001 |
| 50°C | 0 011 0010 | 0 111 0010 |
| 75°C | 0 100 1011 | 1 000 1011 |
| 100°C | 0 110 0100 | 1 010 0100 |
| 125°C | 0 111 1101 | 1 011 1101 |
| 127°C | 0 111 1111 | 1 011 1111 |
| 191°C | 0 111 1111 | 1 111 1111 |

¹ Binary scale temperature measurement returns 0 for all temperatures ≤0°C.

² Offset binary scale temperature values are offset by +64.

While the temperature measurement range can be set to -64°C to +191°C for both local and remote temperature monitoring, the ADT7466 itself should not be exposed to temperatures

greater than those specified in the Absolute Maximum Ratings table. Furthermore, the device is guaranteed to only operate at ambient temperatures from -40°C to +125°C. In practice, the device itself should not be exposed to extreme temperatures, and may need to be shielded in extreme environments to comply with these requirements. Only the remote temperature monitoring diode should be exposed to temperatures above +120°C and below -40°C. Care should be taken in choosing a remote temperature diode to ensure that it can function over the required temperature range.

Nulling Out Temperature Errors

The ADT7466 automatically nulls out temperature measurement errors due to series resistance, but systematic errors in the temperature measurement can arise from a number of sources, and the ADT7466 can reduce these errors. As CPUs run faster, it is more difficult to avoid high frequency clocks when routing the D+, D- tracks around a system board. Even when recommended layout guidelines are followed, there may still be temperature errors attributed to noise being coupled onto the D+/D- lines. High frequency noise generally has the effect of giving temperature measurements that are too high by a constant amount. The ADT7466 has temperature offset registers at addresses 0x26 and 0x27 for the remote and local temperature channels. A one time calibration of the system can determine the offset caused by system board noise and null it out using the offset registers. The offset registers automatically add a twos complement 8-bit reading to every temperature measurement. The LSB adds 1°C offset to the temperature reading so the 8-bit register effectively allows temperature offsets of up to ±128°C with a resolution of 1°C. This ensures that the readings in the temperature measurement registers are as accurate as possible.

Table 12. Temperature Offset Registers

| Register | Description | Default |
|----------|------------------------------|------------|
| 0x24 | Thermistor 1/Remote 2 offset | 0x00 (0°C) |
| 0x25 | Thermistor 2 offset | 0x00 (0°C) |
| 0x26 | Remote1 temperature offset | 0x00 (0°C) |
| 0x27 | Local temperature offset | 0x00 (0°C) |

Table 13. Temperature Measurement Registers

| Register | Description | Default |
|----------|---|---------|
| 0x0D | Remote temperature | 0x00 |
| 0x0E | Local temperature | 0x00 |
| 0x08 | Extended Resolution 1 Bits 1:0 remote temperature LSBs | 0x00 |
| 0x09 | Extended Resolution 2 Bits 1:0 local temperature LSBs | 0x00 |

Associated with each temperature measurement channel are high and low limit registers. Exceeding the programmed high or low limit causes the appropriate status bit to be set. Exceeding either limit can also generate ALERT interrupts.

Table 14. Temperature Measurement Limit Registers

| Register | Description | Default |
|----------|----------------------------------|---------|
| 0x1A | Remote 1 temperature low limit | 0x00 |
| 0x1B | Remote 1 temperature high limit | 0x7F |
| 0x1C | Local temperature low limit | 0x00 |
| 0x1D | Local temperature high limit | 0x7F |
| 0x14 | Thermistor 1/Remote 2 low limit | 0x00 |
| 0x15 | Thermistor 1/Remote 2 high limit | 0xFF |
| 0x16 | Thermistor 2 low limit | 0x00 |
| 0x17 | Thermistor 2 high limit | 0xFF |

All temperature limits must be programmed in the same format as the temperature measurement. If this is offset binary, add 64 (0x40 or 01000000) to the actual temperature limit in degrees Celsius.

Layout Considerations

Digital boards can be electrically noisy environments. Take the following precautions to protect the analog inputs from noise, particularly when measuring the very small voltages from a remote diode sensor.

Place the ADT7466 as close as possible to the remote sensing diode. Provided that the worst noise sources, such as clock generators, data/address buses and CRTs, are avoided, this distance can be 4 inches to 8 inches.

If the distance to the remote sensor is more than 8 inches, the use of twisted-pair cable is recommended. This works from about 6 feet to 12 feet.

For very long distances (up to 100 feet), use shielded twisted pair, such as Belden #8451 microphone cable. Connect the twisted pair to D+ and D- and the shield to GND close to the ADT7466. Leave the remote end of the shield unconnected to avoid ground loops.

Because the measurement technique uses switched current sources, excessive cable and/or filter capacitance can affect the

measurement. When using long cables, the filter capacitor could be reduced or removed.

Route the D+ and D- tracks close together, in parallel, with grounded guard tracks on each side. Provide a ground plane under the tracks if possible.

Use wide tracks to minimize inductance and reduce noise pickup. A 5 mil track minimum width and spacing is recommended.



Figure 25. Arrangement of Signal Tracks

Try to minimize the number of copper/solder joints, which can cause thermocouple effects. Where copper/solder joints are used, make sure that they are in both the D+ and D- paths and are at the same temperature.

Thermocouple effects should not be a major problem because 1°C corresponds to about 240 μV, and thermocouple voltages are about 3 μV/°C of temperature difference. Unless there are two thermocouples with a big temperature differential between them, thermocouple voltages should be much less than 200 mV.

Place a 0.1 μF bypass capacitor close to the ADT7466.

TEMPERATURE MEASUREMENT USING THERMISTORS

The analog input channels, AIN1 and AIN2, can be used to measure temperature by using negative temperature coefficient (NTC) thermistors. NTC thermistors have a nonlinear transfer function of the form

$$R_{t2} = R_{t1} \times e^{\left(\frac{B}{t_2} - \frac{B}{t_1} \right)}$$

where:

R_{t2} is the resistance at temperature t_2 .

R_{t1} is the resistance at temperature t_1 (usually 25°C).

$e = 2.71828$.

B is the B constant of the thermistor (typically between 3000 and 5000).

A thermistor can be made to give a voltage output that is fairly linear over a limited range by making it part of a potential divider as shown in Figure 26.

ADT7466

A potential divider, with a thermistor as the upper part connected to REFOUT, produces an output voltage that varies nonlinearly in proportion to the inverse of the resistance. By suitable choice of thermistor and fixed resistor, this can be made to approximately cancel the nonlinearity of the thermistor resistance vs. temperature curve, thus giving a fairly linear output voltage with temperature over a limited range. This circuit uses REFOUT as the excitation voltage for both the thermistor and for the ADC, so any variation in REFOUT is cancelled, and the measurement is purely ratiometric.

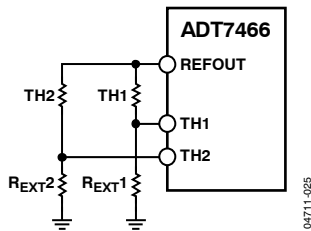

Figure 26. Temperature Measurement Using Thermistor

Thermistor Linearization

A linear transfer function can be obtained over a limited temperature range by connecting the thermistor in series with an optimum resistor. Placing a resistor in series with the thermistor as shown in Figure 26 produces an S-shaped error curve as shown in Figure 27. The overall error across the range can be reduced by calculating the external resistor so that the error is 0 at the ends of the range. R_{EXT} is calculated as follows:

$$R_{EXT} = \frac{R_{MID} \times (R_{MIN} + R_{MAX}) - (2 \times R_{MIN} \times R_{MAX})}{(R_{MIN} + R_{MAX} - 2 \times R_{MID})}$$

where:

R_{MIN} is the thermistor value at T_{MIN} .

R_{MAX} is the thermistor value at T_{MAX} .

R_{MID} is the thermistor value at $\frac{T_{MIN} + T_{MAX}}{2}$

Figure 27 shows the linearity error using a 100 k Ω thermistor with a B value of 3500 and a 14400 Ω resistor. Using the specified thermistor and resistor, the error over a temperature range of 30°C to 100°C is less than $\pm 2^\circ\text{C}$. Other thermistors can be used, but the resistor value is different. A smaller error can be achieved over a narrower temperature range; conversely, a wider temperature range can be used, but the error is greater. In both cases, the optimum resistor value is different.

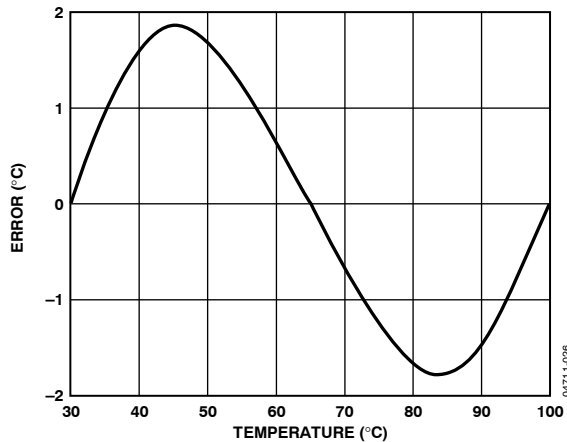

Figure 27. Linearity Error Using Specified Components

Thermistor Normalization

Even when the thermistor is linearized, it does not provide an output to the ADC that gives a direct temperature reading in degrees Celsius. The linearized data is proportional to the voltage applied; however, normalization is needed to use the value as a temperature reading.

To overcome this problem, when an analog input is configured for use with a thermistor, the output of the ADC is scaled and offset so that it produces the same output (for example, 1 LSB = 0.25°C) as from the thermal diode input, when R_{EXT} is chosen to linearize the thermistor over 30°C to 100°C.

Normalization can be chosen for 10 k Ω thermistors by setting Bit 0 of Configuration Register 2 (0x01) or for 100 k Ω thermistors by clearing this bit (default setting).

READING TEMPERATURE FROM THE ADT7466

It is important to note that temperature can be read from the ADT7466 as an 8-bit value (with 1°C resolution) or as a 10-bit value (with 0.25°C resolution). If only 1°C resolution is required, the temperature readings can be read at any time and in no particular order.

If the 10-bit measurement is required, this involves a 2-register read for each measurement. The extended resolution registers (0x08 and 0x09) should be read first. This causes all temperature reading registers to be frozen until all temperature reading registers have been read. This prevents an MSB reading from being updated while its 2 LSBs are being read and vice versa.

Measurement Sequence

The ADT7466 automatically measures each analog and temperature channel in the following round-robin sequence:

1. AIN1/TH1
2. AIN2(TH2)
3. V_{CC}
4. Remote Temperature 1 (D1)
5. Local Temperature

If AIN1 and AIN2 are configured for a second thermal diode, this is measured instead of the AIN1 and AIN 2 measurements, and the result stored in the AIN1 reading register (0x0A).

Analog Monitoring Cycle Time

The analog monitoring cycle begins when a 1 is written to the start bit (Bit 0) of Configuration Register 1 (0x00). The ADC measures each analog input in turn, and, as each measurement is completed, the result is automatically stored in the appropriate value register. This round-robin monitoring cycle continues until disabled by writing a 0 to Bit 0 of Configuration Register 1.

Since the ADC is normally left to free-run in this manner, the time to monitor all the analog inputs is normally not of interest, because the most recently measured value of any input can be read at any time.

For applications where the monitoring cycle time is important, it can easily be calculated from the measurement times of the individual channels. With averaging turned on, each measurement is taken 16 times and the averaged result is placed in the value register. The worst-case monitoring cycle times for averaging turned on and off is described in Table 15.

Fan tach measurements are made in parallel but independently and are not synchronized with the analog measurements.

Table 15. Monitoring Cycle Time

| Channel | Monitoring Cycle Time | |
|--------------------------|-----------------------|-----------------|
| | Avg On | Avg Off |
| Local temperature | 8.99 ms | 1.36 ms |
| Remote 1 temperature | 36.69 ms | 6.25 ms |
| Remote 2 temperature | 36.69 ms | 6.25 ms |
| AIN1/Thermistor 1 | 8.65 ms | 1.02 ms |
| AIN2/Thermistor 2 | 8.65 ms | 1.02 ms |
| V _{CC} | 8.26ms | 0.61 ms |
| Total¹ | 71.24 ms | 10.26ms |
| Total² | 90.63 ms | 14.47 ms |

¹ Pin 11 and Pin 12 configured for AIN/thermistor monitoring. The total excludes the Remote 2 temperature time.

² Pin 11 and Pin 12 configured for second thermal diode monitoring. The total excludes the AIN1/Thermistor 1 and AIN2/Thermistor 2 times.

ADDITIONAL ADC FUNCTIONS

A number of other functions are available on the ADT7466 to offer the systems designer increased flexibility.

Turn Off Averaging

For each temperature measurement read from a value register, 16 readings have actually been made internally and the results averaged before being placed into the value register. The user may want to take a very fast measurement, for example, of CPU temperature. Setting Bit 4 of Configuration Register 2 (0x01) turns averaging off.

Single-Channel ADC Conversions

Setting Bit 3 of Configuration Register 4 (Address 0x03) places the ADT7466 into single-channel ADC conversion mode. In this mode, the ADT7466 can be made to read a single

temperature channel only. The selected input is read every 1.4 ms. The appropriate ADC channel is selected by writing to Bits 2:0 of Configuration Register 4 (Address 0x03).

Table 16. ADC Single-Channel Selection

| Bits 2:0, Reg. 0x03 | Channel Selected |
|---------------------|----------------------|
| 000 | AIN1/ Thermistor1 |
| 001 | AIN2/ Thermistor2 |
| 010 | V _{CC} |
| 011 | Remote 1 temperature |
| 100 | Local temperature |
| 101 | Remote 2 temperature |

LIMIT VALUES

High and low limits are associated with each measurement channel on the ADT7466. These limits can form the basis of system status monitoring; a status bit can be set for any out-of-limit condition and detected by polling the device. Alternatively, ALERT interrupts can be generated to flag out-of-limit conditions for a processor or microcontroller.

Voltage and temperature limits are only 8-bit values and are compared with the 8 MSBs of the voltage and temperature values.

8-Bit Limits

The following tables list the 8-bit limits on the voltage limit and temperature limit registers of the ADT7466.

Table 17. Voltage Limit Registers

| Register | Description | Default |
|----------|----------------------------|---------|
| 0x14 | AIN1 low limit | 0x00 |
| 0x15 | AIN1 high limit | 0xFF |
| 0x16 | AIN2 low limit | 0x00 |
| 0x17 | AIN2 high limit | 0xFF |
| 0x18 | V _{CC} low limit | 0x00 |
| 0x19 | V _{CC} high limit | 0xFF |

Table 18. Temperature Limit Registers

| Register | Description | Default |
|----------|-------------------------------|---------|
| 0x1A | Remote temperature low limit | 0x00 |
| 0x1B | Remote temperature high limit | 0x7F |
| 0x1C | Local temperature low limit | 0x00 |
| 0x1D | Local temperature high limit | 0x7F |
| 0x1E | PROCHOT limit | 0x00 |
| 0x1F | AIN1 (TH1)/REM2 THERM limit | 0x64 |
| 0x20 | AIN2 (TH2) THERM limit | 0x64 |
| 0x21 | Remote THERM limit | 0x64 |
| 0x22 | Local THERM limit | 0x64 |

16-Bit Limits

The fan tach measurements are 16-bit results. The fan tach limits are also 16 bits, consisting of a high byte and low byte. Since fans running under speed or stalled are normally the only conditions of interest, only high limits exist for fan tachs. Since the fan tach period is actually being measured, exceeding the limit indicates a slow or stalled fan.

Table 19. Fan Limit Registers

| Register | Description | Default |
|----------|-------------------------|---------|
| 0x4C | TACH1 minimum low byte | 0xFF |
| 0x4D | TACH1 minimum high byte | 0xFF |
| 0x4E | TACH2 minimum low byte | 0xFF |
| 0x4F | TACH2 minimum high byte | 0xFF |

Out-of-Limit Comparisons

Once all limits have been programmed, ADT7466 monitoring can be enabled. The ADT7466 measures all parameters in round-robin format and sets the appropriate status bit for out-of-limit conditions. Comparisons are done differently depending on whether the measured value is being compared to a high or low limit.

A *greater than* comparison is performed when comparing with the high limit.

A *less than or equal to* comparison is performed when comparing with the low limit.

Status Registers

The results of limit comparisons are stored in Status Register 1 and Status Register 2. The status register bit for each channel reflects the status of the last measurement and limit comparison on that channel. If a measurement is within limits, the corresponding status register bit is cleared to 0. If the measurement is out-of-limits the corresponding status register bit is set to 1.

The state of the various measurement channels can be polled by reading the status registers over the serial bus. When Bit 7 (OOL) of Status Register 1 (0x10) is 1, an out-of-limit event has been flagged in Status Register 2. Therefore the user need only read Status Register 2 when this bit is set. Alternatively, the ALERT output (Pin 14) can be used as an interrupt, which automatically notifies the system supervisor of an out-of-limit condition. Reading the status registers clears the appropriate status bit as long as the error condition that caused the interrupt has cleared. Status register bits are sticky, meaning that they remain set until read by software. Whenever a status bit is set, indicating an out-of-limit condition, it remains set even if the event that caused it cleared (until read). The only way to clear the status bit is to read the status register when the event clears.

Interrupt status mask registers (0x12, 0x13) allow individual interrupt sources to be masked from causing an ALERT.

However, if one of these masked interrupt sources goes out-of-limit, its associated status bit is set in the interrupt status registers.

Table 20. Interrupt Status Register 1 (Reg. 0x10)

| Bit No. | Name | Description |
|---------|------|---|
| 7 | OOL | 1 indicates that a bit in Status Register 2 is set and that Status Register 2 should be read. |
| 6 | AIN1 | 1 indicates that AIN1 is out of limit. |
| 5 | AIN2 | 1 indicates that AIN2 is out of limit. |
| 4 | VCC | 1 indicates that V _{CC} is out of limit. |
| 3 | REM | 1 indicates that the remote temperature measurement is out of limit. |
| 2 | LOC | 1 indicates that the local temperature measurement is out of limit. |
| 1 | FAN1 | 1 indicates that the Tach 1 count is above limit (fan speed below limit). |
| 0 | FAN2 | 1 indicates that the Tach 2 count is above limit (fan speed below limit). |

Table 21. Interrupt Status Register 2 (Reg. 0x11)

| Bit No. | Name | Description |
|---------|-------|---|
| 5 | THRM2 | 1 indicates that TH1 is open-circuit. |
| 4 | THRM1 | 1 indicates that TH2 is open-circuit. |
| 3 | D2 | 1 indicates that Remote Temperature Sensing Diode 2 is open-circuit or short-circuit. |
| 2 | D1 | 1 indicates that Remote Temperature Sensing Diode 1 is open-circuit or short-circuit. |
| 1 | PHOT | 1 indicates that the $\overline{\text{PROCHOT}}$ limit has been exceeded. |
| 0 | OVT | 1 indicates that a $\overline{\text{THERM}}$ overtemperature limit has been exceeded. |

ALERT INTERRUPT BEHAVIOR

The ADT7466 can be polled for status, or an ALERT interrupt can be generated for out-of-limit conditions. It is important to note how the ALERT output and status bits behave when writing interrupt handler software.

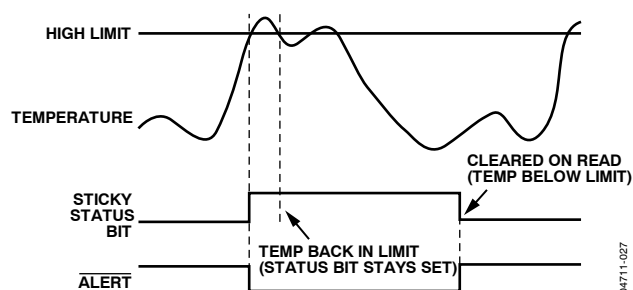

Figure 28. ALERT and Status Bit Behavior

Figure 28 shows how the ALERT output and sticky status bits behave. Once a limit is exceeded, the corresponding status bit is

set to 1. The status bit remains set until the error condition subsides and the status register is read. This ensures that an out-of-limit event cannot be missed if software is polling the device periodically. The ALERT output remains low while a reading is out-of-limit, until the status register is read. This has implications on how software handles the interrupt.

Handling Alert Interrupts

To prevent the system from being tied up servicing interrupts, it is recommended to handle the ALERT interrupt as follows:

1. Detect the ALERT assertion.
2. Enter the interrupt handler.
3. Read the status registers to identify the interrupt source.
4. Mask the interrupt source by setting the appropriate mask bit in the interrupt mask registers (0x12, 0x13).
5. Take the appropriate action for a given interrupt source.
6. Exit the interrupt handler.
7. Periodically poll the status registers. If the interrupt status bit has cleared, reset the corresponding interrupt mask bit to 0. This causes the ALERT output and status bits to behave as shown in Figure 29.

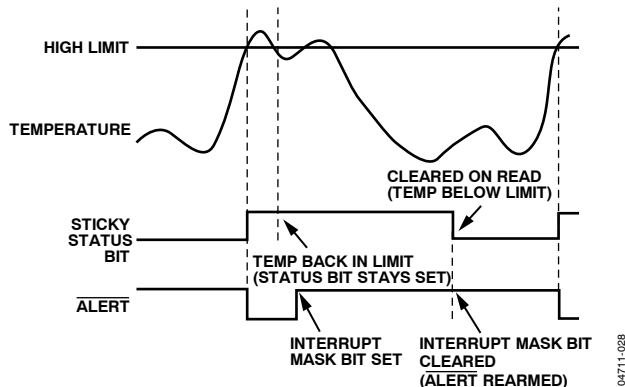

Figure 29. How Masking the Interrupt Source Affects ALERT Output

Masking Interrupt Sources

Interrupt Mask Registers 1 and 2 are located at Addresses 0x12 and 0x13. These registers allow individual interrupt sources to be masked to prevent ALERT interrupts. Masking an interrupt source prevents only the ALERT output from being asserted; the appropriate status bit is set as normal.

Table 22. Interrupt Mask Register 1 (Reg. 0x12)

| Bit No. | Name | Description |
|---------|----------------|---|
| 7 | OOL | 1 masks ALERT for any alert condition flagged in Status Register 2. |
| 6 | AIN1(TH1)/REM2 | 1 masks ALERT for AIN1(TH1)/REM2. |
| 5 | AIN2(TH2) | 1 masks ALERT for AIN2(TH2). |
| 4 | VCC | 1 masks ALERT for Vcc. |
| 3 | REM1 | 1 masks ALERT for remote temperature. |
| 2 | LOC | 1 masks ALERT for local temperature. |
| 1 | FAN1 | 1 masks ALERT for Fan 1. |
| 0 | FAN2 | 1 masks ALERT for Fan 2. |

Table 23. Interrupt Mask Register 2 (Reg. 0x13)

| Bit No. | Name | Description |
|---------|-------|--|
| 5 | THRM2 | 1 masks ALERT for TH1 open- or short-circuit errors. |
| 4 | THRM1 | 1 masks TH2 open- or short-circuit errors. |
| 3 | D1 | 1 masks ALERT for Diode 1 open- or short-circuit errors. |
| 2 | D2 | 1 masks ALERT for Diode 2 open- or short-circuit errors. |
| 1 | PHOT | 1 masks ALERT for PROCHOT. |
| 0 | OVT | 1 masks ALERT for over temperature (exceeding THERM limits). |

Measuring PROCHOT Assertion Time

The ADT7466 has an internal timer to measure PROCHOT assertion time. The timer is started on the assertion of the ADT7466 PROCHOT input, and stopped on the negation of the pin. The timer counts PROCHOT times cumulatively, that is, the timer resumes counting on the next PROCHOT assertion. The PROCHOT timer continues to accumulate PROCHOT assertion times until the timer is read (it is cleared on read) or until it reaches full scale. If the counter reaches full scale, it stops at that reading until it is cleared.

The 8-bit PROCHOT timer register (0x0F) is designed such that Bit 0 is set to 1 on the first PROCHOT assertion. Once the cumulative PROCHOT assertion time exceeds 50 ms, Bit 1 of the PROCHOT timer is set, and Bit 0 becomes the LSB of the timer with a resolution of 22.76 ms.

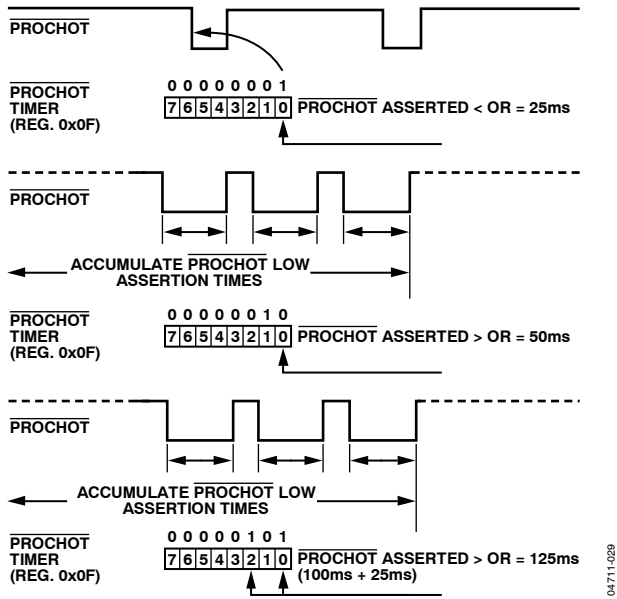

Figure 30. PROCHOT Timer

Figure 30 shows how the PROCHOT timer behaves as the PROCHOT input is asserted and negated. Bit 0 is set on the first PROCHOT assertion that is detected. This bit remains set until the cumulative PROCHOT assertions exceed 50 ms. At this time, Bit 1 of the PROCHOT timer is set, and Bit 0 is cleared. Bit 0 now reflects timer readings with a resolution of 25 ms. When using the PROCHOT timer, be aware of the following.

After a PROCHOT timer read (0x0F):

- The contents of the timer are cleared on read.
- The PHOT bit (Bit 1) of Status Register 2 is cleared automatically.

If the PROCHOT timer is read during a PROCHOT assertion, the following happens:

- The contents of the timer are cleared.
- Bit 0 of the PROCHOT timer is set to 1 (since a PROCHOT assertion is occurring).
- The PROCHOT timer increments from 0.
- If the PROCHOT limit (0x1E) = 0x00, the PHOT bit is set.

Generating ALERT Interrupts from PROCHOT Events

The ADT7466 can generate ALERTs when a programmable PROCHOT limit is exceeded. This allows the systems designer to ignore brief, infrequent PROCHOT assertions, while capturing longer PROCHOT events that could signify a more serious thermal problem within the system. Register 0x1E is the

PROCHOT limit register. This 8-bit register allows a limit from 0 seconds (first PROCHOT assertion) to 6.4 seconds to be set before an ALERT is generated. The PROCHOT timer value is compared with the contents of the PROCHOT limit value. If the PROCHOT timer value exceeds the PROCHOT limit value, the PHOT bit (Bit 1) of Status Register 2 is set, and an ALERT is generated. The PHOT bit (Bit 1) of Mask Register 2 (0x13) masks ALERTs if this bit is set to 1, although the PHOT bit of Interrupt Status Register 2 is still set if the PROCHOT limit is exceeded.

Figure 32 is a functional block diagram of the PROCHOT timer limit and associated circuitry. Writing a value of 0x00 to the PROCHOT limit register (0x21) causes ALERT to be generated on the first PROCHOT assertion. A PROCHOT limit value of 0x01 generates an ALERT when cumulative PROCHOT assertions exceed 50 ms.

CONFIGURING THE ADT7466 THERM PIN AS AN OUTPUT

If PROCHOT monitoring is not required, Pin 7 can be configured as a THERM output by setting Bits 1:0 of Configuration Register 3 to 01. The user can preprogram system critical thermal limits. If the temperature exceeds a thermal limit by 0.25°C, THERM asserts low. If the temperature is still above the thermal limit on the next monitoring cycle, THERM stays low. THERM remains asserted low until the temperature is equal to or below the thermal limit. Since the temperature for that channel is measured only every monitoring cycle, once THERM asserts, it is guaranteed to remain low for at least one monitoring cycle.

The THERM pin can be configured to assert low if the TH1, TH2, external or internal temperature THERM limits are exceeded by 0.25°C. The THERM limit registers are at locations 0x1F, 0x20, 0x21, and 0x22, respectively.

Figure 32 shows how the THERM pin asserts low as an output in the event of a critical overtemperature.

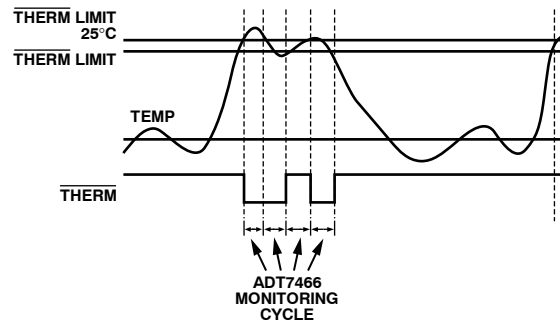

Figure 31. Asserting THERM as an Output Based on Tripping THERM Limits

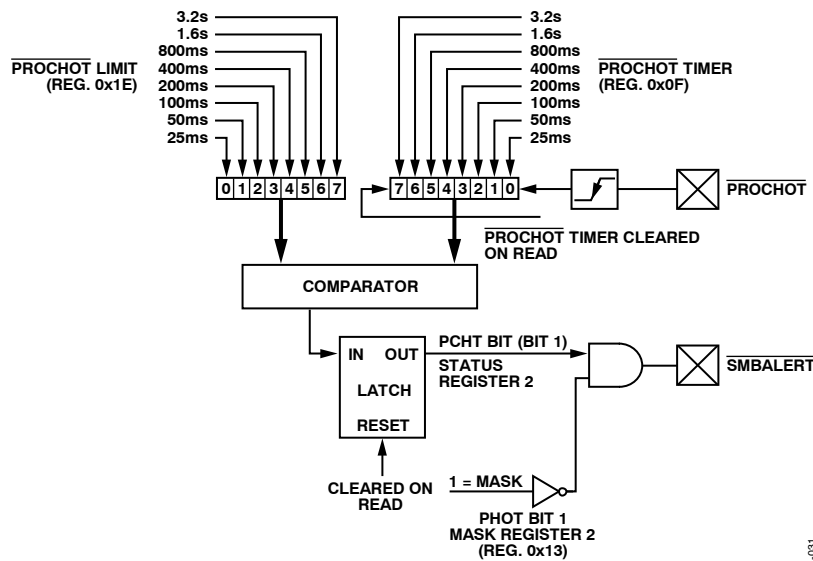

Figure 32. Functional Diagram of the ADT7466 PROCHOT Monitoring Circuitry

FAN DRIVE

The ADT7466 contains two DACs to control fan speed. The full-scale output of these DACs is typically 2.2 V @ 2 mA, so they must be buffered in order to drive 5 V or 12 V fans. The output voltage of these DACs is controlled by data written to the DRIVE1 (0x40) and DRIVE2 (0x41) registers.

Since fans do not turn on below a certain drive voltage, a significant proportion of the DAC range would be unusable; however, four other registers associated with fan speed control help the user to avoid this problem.

Fan start-up voltage registers (0x30 and 0x31) determine the voltage initially applied to the fans at startup. This should be high enough to ensure that the fans start.

Minimum speed registers (0x32 and 0x33) determine the minimum voltage that is applied to the fans. This should be high enough to keep the fans turning and less than the voltage required to start them.

The speed registers associated with automatic fan speed control (AFC) are the maximum speed registers (0x34 and 0x35). They allow the maximum output from the DACs to be limited to less than the full-scale output.

Some suitable fan drive circuits are shown in Figure 33 and Figure 34. Basically, voltage amplification is required to boost the full-scale output of the DAC to 5 V or 12 V, and the amplifier needs sufficient drive current to meet the drive requirements of the fan.

Note that as the external transistor increases the open-loop gain of the op amp, it may be necessary to add a capacitor around the feedback loop to maintain stability.

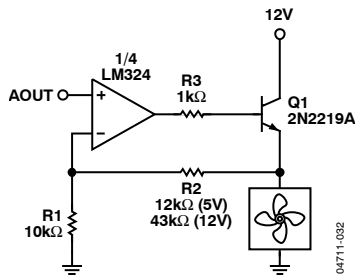

Figure 33. Fan Drive Circuit with Op Amp and Emitter-Follower

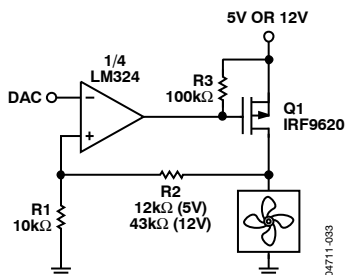

Figure 34. Fan Drive Circuit with P-Channel MOSFET

PWM OR SWITCH MODE FAN DRIVE

Linear dc speed controllers, such as the ones described previously, waste power, which is dissipated as heat in the power transistor. To save power and reduce heat dissipation, it may be desirable to control the fan speed with a more efficient dc-dc converter or a pulse width modulated (PWM) speed controller. In this case, the DRIVE outputs of the ADT7466 provide the reference voltage for this circuit. To maximize efficiency, the controller can be switched off completely whenever the Fan 1 drive value falls below the value in the V_FAN_MIN register. When this happens, the FAN1_ON output goes low.

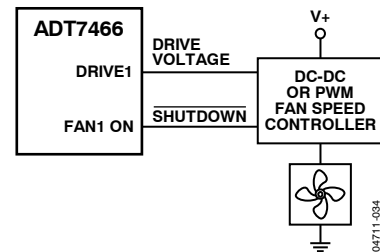

Figure 35. DC-DC or PWM Fan Speed Control

FAN SPEED MEASUREMENT

TACH Inputs

Pin 2 and Pin 4 are tach inputs intended for fan speed measurement. The ADT7466 can measure the speed of 3-wire fans. Each 3-wire fan has two supply wires and a tach output wire. Signal conditioning in the ADT7466 accommodates the slow rise and fall times typical of fan tachometer outputs. The maximum input signal range is 0 V to 6.5 V, even when V_{CC} is less than 5 V. If these inputs are supplied from fan outputs that exceed 0 V to 6.5 V, either resistive attenuation of the fan signal or diode clamping must be included to keep inputs within an acceptable range.

Monitoring 3-Wire Fans

Figure 36 to Figure 39 show circuits for most common 3-wire fan tach outputs.

If the fan tach output has a resistive pull-up to V_{CC}, it can be connected directly to the fan input, as shown in Figure 36.

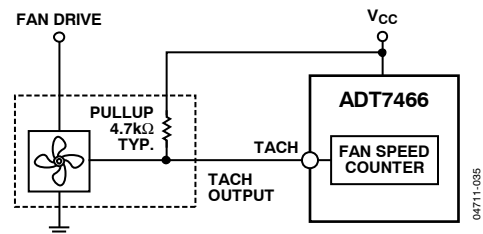

Figure 36. Fan with Tach Pull-Up to +V_{CC}

ADT7466

If the fan output has a resistive pull-up to 12 V (or other voltage greater than 6.5 V), the fan output can be clamped with a Zener diode, as shown in Figure 37. The Zener diode voltage should be greater than V_{IH} of the tach input but less than 6.5 V, allowing for the voltage tolerance of the Zener. A value of between 3 V and 5 V is suitable.

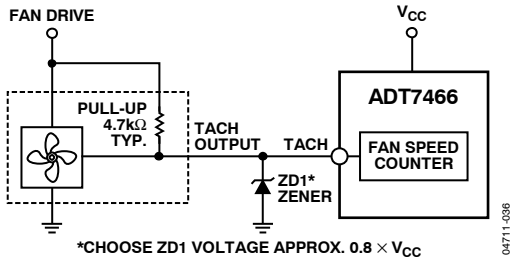

Figure 37. Fan with Tach.

Pull-Up to Voltage >6.5 V, for Example, 12 V Clamped with Zener Diode.

If the fan has a strong pull-up (less than 1 kΩ) to 12 V, or a totem pole output, a series resistor can be added to limit the Zener current, as shown in Figure 38. Alternatively, a resistive attenuator can be used, as shown in Figure 39.

R1 and R2 should be chosen such that

$$2 V < V_{PULLUP} \times R2 / (R_{PULLUP} + R1 + R2) < 5 V$$

The fan inputs have an input resistance of nominally 160 kΩ to ground, which should be taken into account when calculating resistor values.

With a pull-up voltage of 12 V and pull-up resistor less than 1 kΩ, suitable values for R1 and R2 are 100 kΩ and 47 kΩ. This gives a high input voltage of 3.83 V.

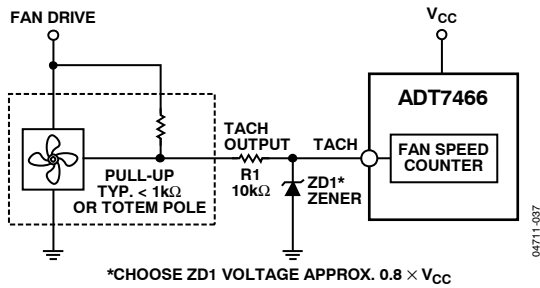

Figure 38. Fan with Strong Tach.

Pull-Up to >VCC or Totem Pole Output, Clamped with Zener and Resistor.

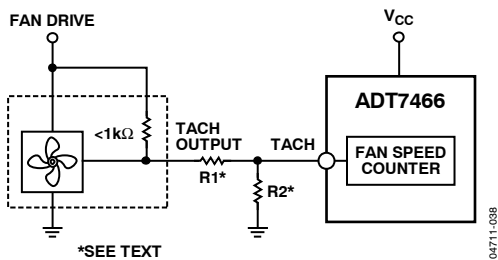

Figure 39. Fan with Strong Tach.

Pull-Up to >VCC or Totem Pole Output, Attenuated with R1/R2.

Fan Speed Registers

The fan counter does not count the fan tach output pulses directly because the fan speed can be less than 1000 rpm; it would take several seconds to accumulate a reasonably large and accurate count. Instead, the period of the fan revolution is measured by gating an on-chip 82 kHz oscillator into the input of a 16-bit counter for N periods of the fan tach output, as shown in Figure 40. The accumulated count is actually proportional to the fan tachometer period and inversely proportional to the fan speed.

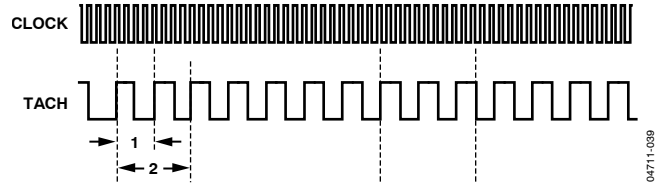

Figure 40. Fan Speed Measurement

N, the number of pulses counted, is determined by the settings of Register 0x39 (fan pulses per revolution register). This register contains 2 bits for each fan, allowing 1, 2 (default), 3 or 4 tach pulses to be counted.

The fan tachometer readings are 16-bit values consisting of a 2-byte read from the ADT7466.

Table 24. Fan Speed Measurement Registers

| Register | Description | Default |
|----------|-----------------|---------|
| 0x48 | TACH1 low byte | 0xFF |
| 0x49 | TACH1 high byte | 0xFF |
| 0x4A | TACH2 low byte | 0xFF |
| 0x4B | TACH2 high byte | 0xFF |

Reading Fan Speed from the ADT7466

Measuring fan speeds involves a 2-register read for each measurement. The low byte should be read first, which causes the high byte to be frozen until both high and low byte registers are read. This prevents erroneous tach readings.

The fan tachometer reading registers report the number of 12.2 μs period clocks (82 kHz oscillator) gated to the fan speed counter from the rising edge of the first fan tach pulse to the rising edge of the third fan tach pulse, assuming two pulses per revolution is being counted. Since the device is essentially measuring the fan tach period, the higher the count value, the slower the fan is actually running. A 16-bit fan tachometer reading of 0xFFFF indicates either that the fan has stalled or that it is running very slowly (<75 rpm).

A greater than comparison is performed when comparing with the high limit.

The actual fan tach period is being measured in this case. Therefore, when the fan tach limit is exceeded, a 1 is set for the appropriate status bit and can be used to generate an ALERT.

The fan tach limit registers are 16-bit values consisting of 2 bytes.

Table 25. Fan Tach Limit Registers

| Register | Description | Default |
|----------|-------------------------|---------|
| 0x4C | TACH1 minimum low byte | 0xFF |
| 0x4D | TACH1 minimum high byte | 0xFF |
| 0x4E | TACH2 minimum low byte | 0xFF |
| 0x4F | TACH2 minimum high byte | 0xFF |

Fan Speed Measurement Rate

The fan tach readings are normally updated once every second.

The FAST bit (Bit 3) of Configuration Register 3 (0x02) updates the fan tach readings every 250 ms, when set to 1. If any of the fans are not being driven by a fan drive output, but are powered directly from 5 V or 12 V, its associated dc bit in Configuration Register 3 should be set. This allows tach readings to be taken on a continuous basis for fans connected directly to a dc source.

Calculating Fan Speed

Assuming a fan with two pulses/revolution (and two pulses/revolution being measured) fan speed is calculated by

$$\text{Fan Speed (rpm)} = (82000 \times 60) / \text{Fan Tach Reading}$$

where *Fan Tach Reading* is the 16-bit fan tachometer reading.

For example, if

TACH1 High Byte (Reg. 0x49) = 0x17

TACH1 Low Byte (Reg. 0x48) = 0xFF

then fan speed in rpm is

Fan 1 TACH reading = 0x17FF = 6143 decimal

rpm = (82000 × 60) / Fan 1 TACH reading

rpm = (82000 × 60) / 6143 = 800 = fan speed

Fan Pulses Per Revolution

Different fan models can output either 1, 2, 3, or 4 tach pulses per revolution. Once the number of fan tach pulses is determined, it can be programmed into the fan pulses per revolution register (0x39) for each fan. Alternatively, this register can be used to determine the number of pulses/revolution output by a given fan. By plotting fan speed measurements at 100% speed with different pulses/revolution settings, the smoothest graph with the lowest ripple determines the correct pulses/revolution value.

Table 26. Fan Pulses Per Revolution Register

| Fan | Default |
|----------|-------------------------|
| 1:0 FAN1 | 2 pulses per revolution |
| 3:2 FAN2 | 2 pulses per revolution |

Table 27. Fan Pulses Per Revolution Values

| Code | Pulses per Revolution |
|------|-----------------------|
| 00 | 1 |
| 01 | 2 |
| 10 | 3 |
| 11 | 4 |

The ADT7466 has a unique fan spin-up function. It spins the fan with the fan start-up voltage until two tach pulses are detected on the tach input. Once two pulses are detected, the fan drive goes to the expected running value. The advantage of this is that fans have different spin-up characteristics and take different times to overcome inertia. The ADT7466 runs the fans just fast enough to overcome inertia and is quieter on spin-up than fans programmed to spin-up for a given spin-up time.

FAN START-UP TIMEOUT

To prevent false interrupts being generated as a fan spins up (since it is below running speed), the ADT7466 includes a fan start-up timeout function. This is the time limit allowed for two tach pulses to be detected on spin-up. For example, if a 2-second fan start-up timeout is chosen, and no tach pulses occur within two seconds of the start of spin-up, a fan fault is detected and flagged in Interrupt Status Register 1.

Start-Up Timeout Configuration (Reg. 0x38)

Bits 2:0 control the start-up timeout for DRIVE1. Bits 5:3 control the start-up timeout for DRIVE2.

Table 28. Start-Up Timeout Configuration

| Code | Timeout |
|------|---------------------|
| 000 | No start-up timeout |
| 001 | 100 ms |
| 010 | 250 ms |
| 011 | 400 ms |
| 100 | 667 ms |
| 101 | 1 second |
| 110 | 2 seconds |
| 111 | 4 seconds |

AUTOMATIC FAN SPEED CONTROL

The ADT7466 has a local temperature sensor and a remote temperature channel, which can be connected to an on-chip diode-connected transistor on a CPU. In addition, the two analog input channels can be reconfigured for temperature measurement. Any or all of these temperature channels can be used as the basis for automatic fan speed control to drive fans according to system temperature. By running the fans at only the speed needed to maintain a desired temperature, acoustic noise is reduced. Reducing fan speed can also decrease system current consumption.

To use automatic fan control (AFC), a number of parameters must be set up.

Which Temperature Channel Controls Which Fan?

This is determined by the AFC configuration registers (0x05 and 0x06). AFC1 configuration register controls Fan 1, and AFC2 configuration register controls Fan 2. Setting bits in these registers decides which temperature channels controls the fan.

Table 29. AFC Configuration Registers

| Bit | Description |
|-------|--|
| Bit 0 | Fan controlled by TH1 or REM2 |
| Bit 1 | Fan controlled by TH2 |
| Bit 2 | Fan controlled by Remote Temperature 1 |
| Bit 3 | Fan controlled by local temperature |
| Bit 4 | Fan under manual control |
| Bit 5 | Fan at minimum speed |
| Bit 6 | Fan at start-up speed |
| Bit 7 | Fan at maximum speed |

If more than one of the temperature channel Bits 0:3 are set, the channel that demands the highest fan speed takes control. When TH1 and TH2 are set up as AIN1 and AIN2, these pins still control the AFC loop if Bits 0:1 in the AFC configuration register are set. Bits 0:1 should not be set in analog input mode.

If the manual control bit is set, AFC is switched off and the DRIVE registers can be programmed manually. This overrides any setting of the temperature channel bits. The maximum RPM registers, 0x34 and 0x35, should be set to 0x00 when the fans are under manual control.

If the minimum speed bit is set, AFC is switched off and the fan runs at minimum speed. This overrides any setting of Bits 4:0.

If the start-up speed bit is set, AFC is switched off and the fan runs at start-up speed. This overrides any setting of Bits 5:0.

If the maximum speed bit is set, AFC is switched off and the fan runs at maximum speed. This overrides any setting of Bits 6:0.

Fan Start Voltage (V_FAN_ON)

This is the minimum drive voltage from the DAC at which a fan starts running. This depends on the parameters of the fan and the characteristics of the fan drive circuit.

Minimum Fan Speed (V_FAN_MIN)

This is the minimum drive voltage from the DAC at which a fan keeps running, which is lower than the voltage required to start it. This depends on the parameters of the fan and the characteristics of the fan drive circuit.

Maximum Fan Speed

For acoustic reasons it may be desirable to limit the maximum rpm of the fans. These values are programmed into the maximum fan speed registers (0x34 and 0x35). During AFC, the fan speed is monitored and is never allowed to exceed the programmed limit, even if the AFC loop demands it. However, the maximum fan speed limit can be overridden by a THERM event, which sets the fan drive to full scale (full speed) for emergency cooling.

Operating Temperature Range

The temperature range over which AFC operates can be programmed by using the TMIN and TRANGE registers.

TMIN is the temperature at which a fan starts and runs at minimum speed when in AFC mode. TRANGE is the temperature range over which AFC operates. Thus, if TMIN is set to 40°C and TRANGE is set to 20°C, the fan starts when the temperature exceeds 40°C and the fan reaches maximum speed at a temperature of 60°C.

Enhanced Acoustics

When fan speed is controlled automatically, a temperature event can cause the fan drive output to change instantaneously to a new value. The sudden subsequent change in fan speed can cause an audible noise pulse. To avoid this problem, the ADT7466 can be programmed so that the drive value changes in a series of small steps, using the enhanced acoustics register (0x36).

Bits 2:0 of this register allow eight step sizes from 1 to 48 bits to be selected for Fan 1. Bits 5:3 do the same for Fan 2. When automatic fan control requires a change in drive value, the value changes by the step size once every 250 ms until the final value is reached. For example, if the step size is 3 and the drive value changes from 137 to 224, the drive value takes 29 ms × 250 ms to reach its final value.

Enhanced acoustics for the Fan 1 output (DRIVE1) can be enabled by setting Bit 6 of the enhanced acoustics register, and by setting Bit 7 for Fan 2 (DRIVE2).

AFC Loop Operation

The automatic fan speed control loop operates as follows.

Once the temperature exceeds T_MIN , the ADT7466 outputs the voltage V_FAN_ON on its DRIVE pin. For Fan 1, FAN1 ON is also asserted. When the fan starts rotating reliably, the drive voltage is reduced to V_FAN_MIN . Reliable startup is determined when two tachometer pulses are sensed on the tach input. As the measured temperature increases, the voltage output by the ADT7466 also increases linearly. The rate with which the voltage output (fan speed) increases is controlled by the T_RANGE parameter.

Once the measured fan speed reaches a programmable maximum limit, the fan speed does not increase further. This is to maintain low acoustics. If, however, the $THERM$ fail safe limit is breached, the fans immediately run to full speed (0xFF). They continue to run at full speed until the temperature falls by a programmable hysteresis value below the $THERM$ limit. Then the fan speed reduces to its value before the $THERM$ limit is exceeded.

As the temperature decreases, the fan speed decreases along the same curve. Once the temperature falls below T_MIN , the fan runs at V_FAN_MIN . If the temperature continues to decrease, the fan can continue to run at V_FAN_MIN , or if the temperature drops below a hysteresis value, the fan can be switched off completely. This is controlled by Bits 4:5 of Configuration Register 4. Setting these bits ensures that the fans never go below minimum speed. FAN 1 ON is also deasserted when the fan drive is set to 0 V.

The fan speed is updated every 250 ms to 500 ms in the automatic fan speed control loop.

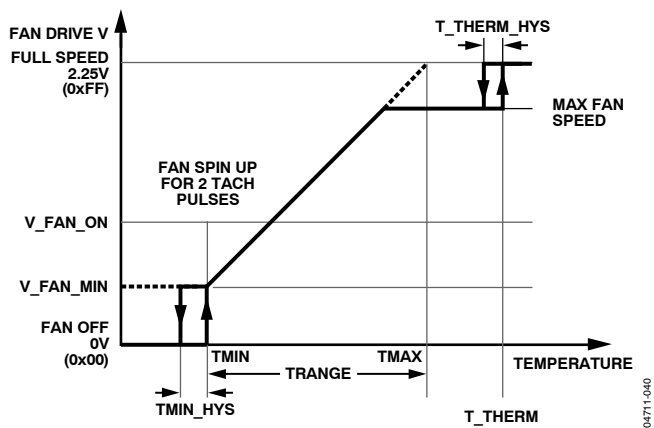

Figure 41. Operation of AFC Loop

STARTING THE FAN

Under normal conditions, the V_FAN_ON register sets DRIVE at a voltage sufficient to start the fan rotating. Fan startup is confirmed after two tach pulses are generated.

1. Set the initial V_FAN_ON by BIOS.
2. Wait for two tach pulses (up to 2 seconds maximum).
3. If successful, set the drive to V_FAN_MIN and follow the automatic slope.

If not successful, increase the V_FAN_ON voltage on DRIVE by a programmed value (set in step size register) and return to Step 1. This sequence can be repeated five times or until DRIVE is set at full scale. If the fan still fails to start, the FANLOCK pin is asserted.

4. Set the drive at 0 V (to avoid high power dissipation).
5. Wait 1 minute and repeat the entire sequence. (This sequence recovers the situation if the fan is temporarily stalled due a mechanical reason such as jammed with a stick.)

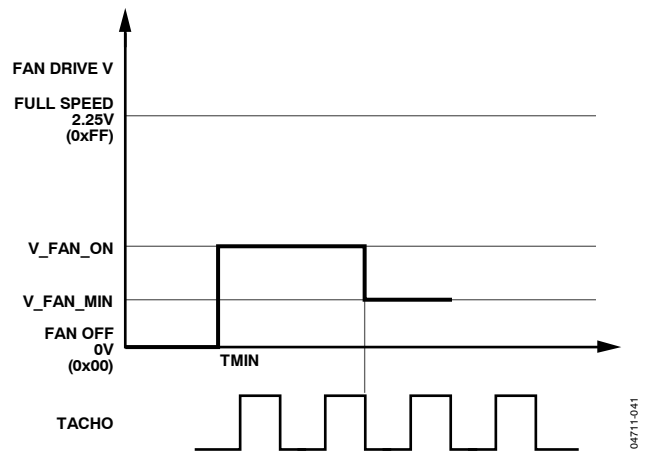

Figure 42. Normal Fan Starting Timing Diagram

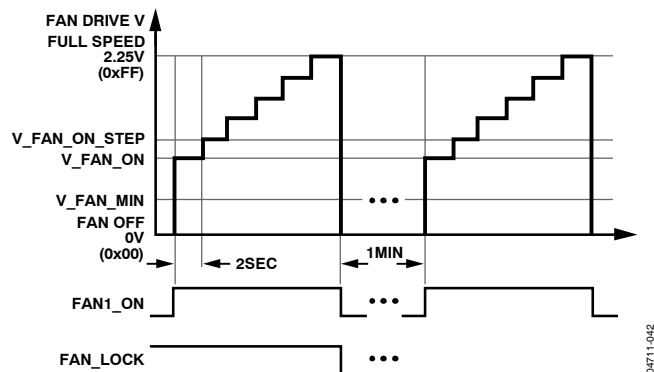

Figure 43. Abnormal Fan Starting (Fan Stalled)

XOR TEST MODE

The ADT7466 includes an XOR tree test mode. This mode is useful for in-circuit test equipment at board-level testing. By applying stimulus to the pins included in the XOR tree, it is possible to detect opens or shorts on the system board. Figure 44 shows the signals that are exercised in the XOR tree test mode.

The XOR tree test is invoked by setting Bit 0 (XEN) of the XOR tree test enable register (0x42). Pin 7 should be configured as a $\overline{\text{PROCHOT}}$ input by setting Bit 1 (P7C1) of Configuration Register 3 (0x02). The $\overline{\text{PROCHOT}}$ mask bit (Reg. 0x13, Bit 1) should also be set.

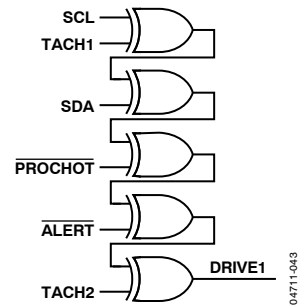

Figure 44. ADT7466 XOR Tree

APPLICATION CIRCUIT

Figure 45 shows a typical application circuit diagram for the ADT7466. The analog inputs are configured for thermistor temperature monitoring. Inputs D+ and D- are used to measure the temperature of a discrete transistor. In an actual application, every input and output may not be used. In this case, unused analog and digital inputs should be tied to ground. Pull-up resistors are required on SCL, SDA, FAN1_ON, PROCHOT/THERM, and FANLOCK. There are two drive outputs which control the speed of two fans. There are also two tach inputs from the fans for monitoring the fan speed.

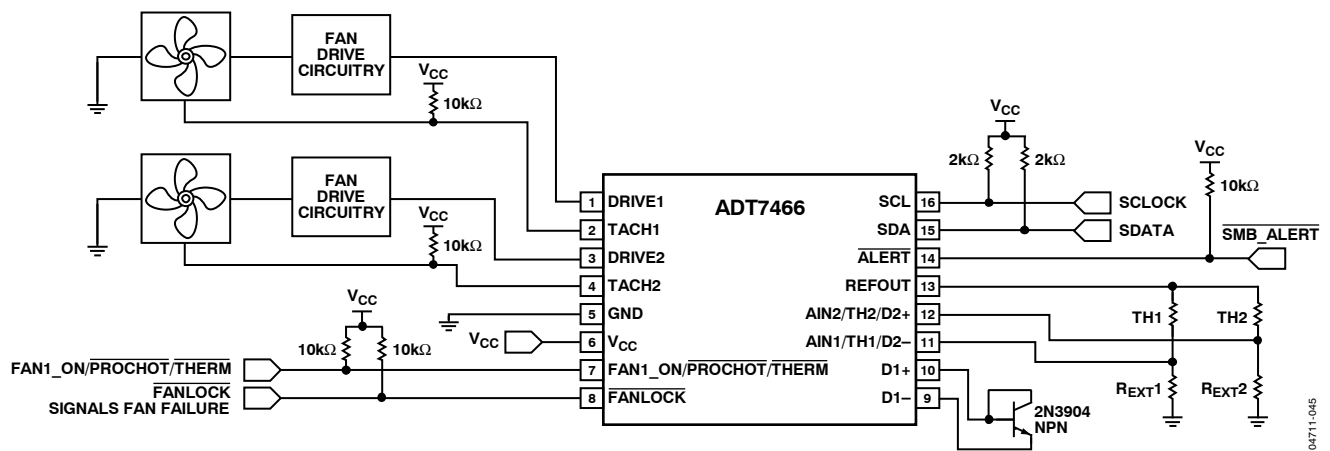

Figure 45. Typical Application Circuit

04711-045

ADT7466

ADT7466 REGISTER MAP

Table 30. ADT7466 Registers

| Addr. | R/W | Name | Description | Bit 7 | Bit 6 | Bit 5 | Bit 4 | Bit 3 | Bit 2 | Bit 1 | Bit 0 | Default | Lockable |
|-------|-----|-----------------|----------------------------|--------|--------------------|-----------|-----------------|-------|-------|-------|---------------|---------|----------|
| 0x00 | R/W | CONF1 | Configuration 1 | OBIN | Vcc | TODIS | FSPDIS | FSPD | RDY | LOCK | STRT | 0x01 | Yes |
| 0x01 | R/W | CONF2 | Configuration 2 | REM2 | SHDN | RATE | AVG | | REFZ | CURR | RTYPE | 0x00 | Yes |
| 0x02 | R/W | CONF3 | Configuration 3 | THER 2 | THER1 | DC2 | DC1 | FAST | BOOST | P7C1 | P7C0 | 0xC0 | Yes |
| 0x03 | R/W | CONF4 | Configuration 4 | | | MIN2 | MIN1 | SNGL | CH2 | CH1 | CH0 | 0x00 | Yes |
| 0x04 | R/W | CONF5 | Reserved | | | | | | | | | 0x00 | Yes |
| 0x05 | R/W | AFC1 | AFC1 Configuration | MAX | STRT | MIN | MAN | LOC | REM | TH2 | TH1 | 0x0C | Yes |
| 0x06 | R/W | AFC2 | AFC2 Configuration | MAX | STRT | MIN | MAN | LOC | REM | TH2 | TH1 | 0x0C | Yes |
| 0x07 | | | Reserved | 7 | 6 | 5 | 4 | 3 | 2 | 1 | 0 | 0x00 | Yes |
| 0x08 | R | EXT1 | Extended Resolution 1 | AIN1-1 | AIN1-0 | AIN2-1 | AIN2-0 | VCC1 | VCC0 | REM1 | REM0 | 0x00 | |
| 0x09 | R | EXT2 | Extended Resolution 2 | | | | | | | LOC1 | LOC0 | 0x00 | |
| 0x0A | R | AIN1 | AIN1(TH1)/REM2 Reading | 9 | 8 | 7 | 6 | 5 | 4 | 3 | 2 | 0x00 | |
| 0x0B | R | AIN2 | AIN2(TH2) Reading | 9 | 8 | 7 | 6 | 5 | 4 | 3 | 2 | 0x00 | |
| 0x0C | R | V _{cc} | V _{cc} Reading | 9 | 8 | 7 | 6 | 5 | 4 | 3 | 2 | 0x00 | |
| 0x0D | R | REM1 | Remote1 Temp Reading | 9 | 8 | 7 | 6 | 5 | 4 | 3 | 2 | 0x00 | |
| 0x0E | R | LOC | Local Temp Reading | 9 | 8 | 7 | 6 | 5 | 4 | 3 | 2 | 0x00 | |
| 0x0F | R | PCHT | PROCHOT Reading | TMR | TMR | TMR | TMR | TMR | TMR | TMR | ASRT/ TMR0 | 0x00 | |
| 0x10 | R | INT1 | Interrupt Status 1 | OOL | AIN1(TH1)/ REM2 | AIN2(TH2) | V _{cc} | REM1 | LOC | FAN1 | FAN2 | 0x00 | |
| 0x11 | R | INT2 | Interrupt Status 2 | | | TH2 | TH1 | D2 | D1 | PHOT | OVT | 0x00 | |
| 0x12 | R/W | MASK1 | Interrupt Mask 1 | OOL | AIN1(TH1)/ REM2 | AIN2(TH2) | V _{cc} | REM | LOC | FAN1 | FAN2 | 0x00 | |
| 0x13 | R/W | MASK2 | Interrupt Mask 2 | | | TH2 | TH1 | D2 | D1 | PHOT | OVT | 0x00 | |
| 0x14 | R/W | AIN1LOW | AIN1(TH1)/REM2 Low Limit | 7 | 6 | 5 | 4 | 3 | 2 | 1 | 0 | 0x00 | |
| 0x15 | R/W | AIN1HIGH | AIN1(TH1)/REM2 High Limit | 7 | 6 | 5 | 4 | 3 | 2 | 1 | 0 | 0xFF | |
| 0x16 | R/W | AIN2LOW | AIN2(TH2) Low Limit | 7 | 6 | 5 | 4 | 3 | 2 | 1 | 0 | 0x00 | |
| 0x17 | R/W | AIN2HIGH | AIN2(TH2) High Limit | 7 | 6 | 5 | 4 | 3 | 2 | 1 | 0 | 0xFF | |
| 0x18 | R/W | VCCLOW | V _{cc} Low Limit | 7 | 6 | 5 | 4 | 3 | 2 | 1 | 0 | 0x00 | |
| 0x19 | R/W | VCCHIGH | V _{cc} High Limit | 7 | 6 | 5 | 4 | 3 | 2 | 1 | 0 | 0xFF | |
| 0x1A | R/W | REM1LOW | Remote1 Temp Low Limit | 7 | 6 | 5 | 4 | 3 | 2 | 1 | 0 | 0x00 | |
| 0x1B | R/W | REM1HIGH | Remote1 Temp High Limit | 7 | 6 | 5 | 4 | 3 | 2 | 1 | 0 | 0x7F | |
| 0x1C | R/W | LOCLow | Local Temp Low Limit | 7 | 6 | 5 | 4 | 3 | 2 | 1 | 0 | 0x00 | |
| 0x1D | R/W | LOCHigh | Local Temp High Limit | 7 | 6 | 5 | 4 | 3 | 2 | 1 | 0 | 0x7F | |
| 0x1E | R/W | PCHTLIM | PROCHOT Limit | LIMT | LIMT | LIMT | LIMT | LIMT | LIMT | LIMT | LIMT | 0x00 | Yes |
| 0x1F | R/W | AIN1THERM | AIN1(TH1)/REM2 Therm Limit | 7 | 6 | 5 | 4 | 3 | 2 | 1 | 0 | 0x64 | Yes |
| 0x20 | R/W | AIN2THERM | AIN2(TH2) Therm Limit | 7 | 6 | 5 | 4 | 3 | 2 | 1 | 0 | 0x64 | Yes |
| 0x21 | R/W | REM1THERM | Remote 1 Therm Limit | 7 | 6 | 5 | 4 | 3 | 2 | 1 | 0 | 0x64 | Yes |
| 0x22 | R/W | LOCTHERM | Local Therm Limit | 7 | 6 | 5 | 4 | 3 | 2 | 1 | 0 | 0x64 | Yes |
| 0x23 | R/W | | Reserved | 7 | 6 | 5 | 4 | 3 | 2 | 1 | 0 | 0x00 | Yes |
| 0x24 | R/W | AIN1OFS | AIN1(TH1)/REM2 Offset | 7 | 6 | 5 | 4 | 3 | 2 | 1 | 0 | 0x00 | Yes |
| 0x25 | R/W | AIN2OFS | AIN2(TH2) Offset | 7 | 6 | 5 | 4 | 3 | 2 | 1 | 0 | 0x00 | Yes |
| 0x26 | R/W | REM1OFS | Remote1 Temp Offset | 7 | 6 | 5 | 4 | 3 | 2 | 1 | 0 | 0x00 | Yes |
| 0x27 | R/W | LOCOFS | Local Temp Offset | 7 | 6 | 5 | 4 | 3 | 2 | 1 | 0 | 0x00 | Yes |
| 0x28 | R/W | AIN1TMIN | AIN1(TH1)/REM2 TMIN | 7 | 6 | 5 | 4 | 3 | 2 | 1 | 0 | 0x5A | Yes |
| 0x29 | R/W | AIN2TMIN | AIN2(TH2) TMIN | 7 | 6 | 5 | 4 | 3 | 2 | 1 | 0 | 0x5A | Yes |
| 0x2A | R/W | REM1TMIN | Remote1 TMIN | 7 | 6 | 5 | 4 | 3 | 2 | 1 | 0 | 0x5A | Yes |
| 0x2B | R/W | LOCTMIN | Local TMIN | 7 | 6 | 5 | 4 | 3 | 2 | 1 | 0 | 0x5A | Yes |
| 0x2C | R/W | THTRANGE | TH1(REM2)/TH2 | TH1R3 | TH1R2 | TH1R1 | TH1R0 | TH2R3 | TH2R2 | TH2R1 | TH2R0 | 0xCC | Yes |

| Addr. | R/W | Name | Description | Bit 7 | Bit 6 | Bit 5 | Bit 4 | Bit 3 | Bit 2 | Bit 1 | Bit 0 | Default | Lockable |
|-------|-----|-----------|-------------------------------|--------|--------|--------|--------|--------|--------|--------|--------|---------|----------|
| | | | TRANGE | | | | | | | | | | |
| 0x2D | R/W | R1LTRANGE | REM1,LOC TRANGE | RM1R3 | RM1R2 | RM1R1 | RM1R0 | LOR3 | LOR2 | LOR1 | LOR0 | 0xCC | Yes |
| 0x2E | R/W | THTHYS | TH1,TH2 THyst | TH1TH3 | TH1TH2 | TH1TH1 | TH1TH0 | TH2TH3 | TH2TH2 | TH2TH1 | TH2TH0 | 0x44 | Yes |
| 0x2F | R/W | R1LTHYS | Rem1/ Local THyst | RM1H3 | RM1H2 | RM1H1 | RM1H0 | LOH3 | LOH2 | LOH1 | LOH0 | 0x44 | Yes |
| 0x30 | R/W | FAN1START | Fan1 Start-up Voltage | 7 | 6 | 5 | 4 | 3 | 2 | 1 | 0 | 0x80 | Yes |
| 0x31 | R/W | FAN2START | Fan2 Start-up Voltage | 7 | 6 | 5 | 4 | 3 | 2 | 1 | 0 | 0x80 | Yes |
| 0x32 | R/W | FAN1MIN | Fan1 Min Voltage | 7 | 6 | 5 | 4 | 3 | 2 | 1 | 0 | 0x60 | Yes |
| 0x33 | R/W | FAN2MIN | Fan2 Min Voltage | 7 | 6 | 5 | 4 | 3 | 2 | 1 | 0 | 0x60 | Yes |
| 0x34 | R/W | FAN1MAX | Fan1 Max RPM (High Byte) | 7 | 6 | 5 | 4 | 3 | 2 | 1 | 0 | 0x20 | Yes |
| 0x35 | R/W | FAN2MAX | Fan2 Max RPM (High Byte) | 7 | 6 | 5 | 4 | 3 | 2 | 1 | 0 | 0x20 | Yes |
| 0x36 | R/W | ENHANCED | Enhanced Acoustics | FAN2EN | FAN1EN | FAN2-2 | FAN2-1 | FAN2-0 | FAN1-2 | FAN1-1 | FAN1-0 | 0x3F | Yes |
| 0x37 | R/W | FAULTINC | Fault Increment | 7 | 6 | FAN2-2 | FAN2-1 | FAN2-0 | FAN1-2 | FAN1-1 | FAN1-0 | 0x3F | Yes |
| 0x38 | R/W | TIMEOUT | Startup Timeout Configuration | | | ST2-2 | ST2-1 | ST2-0 | ST1-2 | ST1-1 | ST1-0 | 0x00 | Yes |
| 0x39 | R/W | PULSES | Fan Pulses per Revolution | | | | | FAN2 | FAN2 | FAN1 | FAN1 | 0x05 | |
| 0x3A | R/W | | Reserved | 7 | 6 | 5 | 4 | 3 | 2 | 1 | 0 | 0x00 | Yes |
| 0x3B | R/W | | Not Used | | | | | | | | | | |
| 0x3C | R/W | | Not Used | | | | | | | | | | |
| 0x3D | R/W | ID | Device ID Register | 7 | 6 | 5 | 4 | 3 | 2 | 1 | 0 | 0x66 | |
| 0x3E | R | COMPANY | Company ID Number | 7 | 6 | 5 | 4 | 3 | 2 | 1 | 0 | 0x41 | |
| 0x3F | R | REV | Revision Number | VER | VER | VER | VER | VER | VER | VER | VER | 0x02 | |
| 0x40 | R/W | DRIVE 1 | Drive 1 | 7 | 6 | 5 | 4 | 3 | 2 | 1 | 0 | 0x00 | |
| 0x41 | R/W | DRIVE 2 | Drive 2 | 7 | 6 | 5 | 4 | 3 | 2 | 1 | 0 | 0x00 | |
| 0x42 | R/W | XOR | XOR Tree Test Enable | | | | | | | | XEN | 0x00 | Yes |
| 0x43 | R/W | | Reserved | 7 | 6 | 5 | 4 | 3 | 2 | 1 | 0 | 0x00 | Yes |
| 0x44 | R/W | | Reserved (Target Monitor1) | 7 | 6 | 5 | 4 | 3 | 2 | 1 | 0 | 0x00 | |
| 0x45 | R/W | | Reserved (Target Monitor2) | 7 | 6 | 5 | 4 | 3 | 2 | 1 | 0 | 0x00 | |
| 0x46 | R/W | | Not Used | | | | | | | | | | |
| 0x47 | R/W | | Not Used | | | | | | | | | | |
| 0x48 | R | TACH1L | Tach1 Low Byte | 7 | 6 | 5 | 4 | 3 | 2 | 1 | 0 | 0xFF | |
| 0x49 | R | TACH1H | Tach1 High Byte | 15 | 14 | 13 | 12 | 11 | 10 | 9 | 8 | 0xFF | |
| 0x4A | R | TACH2L | Tach2 Low Byte | 7 | 6 | 5 | 4 | 3 | 2 | 1 | 0 | 0xFF | |
| 0x4B | R | TACH2H | Tach2 High Byte | 15 | 14 | 13 | 12 | 11 | 10 | 9 | 8 | 0xFF | |
| 0x4C | R/W | TACH1LOW | Tach1 Minimum Low Byte | 7 | 6 | 5 | 4 | 3 | 2 | 1 | 0 | 0xFF | |
| 0x4D | R/W | TACH1HIGH | Tach1 Minimum High Byte | 7 | 6 | 5 | 4 | 3 | 2 | 1 | 0 | 0xFF | |
| 0x4E | R/W | TACH2LOW | Tach2 Minimum Low Byte | 7 | 6 | 5 | 4 | 3 | 2 | 1 | 0 | 0xFF | |
| 0x4F | R/W | TACH2HIGH | Tach2 Minimum High Byte | 7 | 6 | 5 | 4 | 3 | 2 | 1 | 0 | 0xFF | |
| 0x50 | R/W | TEST1 | Test Register1 | 7 | 6 | 5 | 4 | 3 | 2 | 1 | 0 | 0x00 | Yes |
| 0x51 | R/W | TEST2 | Test Register2 | 7 | 6 | 5 | 4 | 3 | 2 | 1 | 0 | 0x00 | Yes |
| 0x52 | R/W | TEST3 | Test Register3 | 7 | 6 | 5 | 4 | 3 | 2 | 1 | 0 | 0x00 | Yes |
| 0x53 | R/W | TEST4 | Test Register4 | 7 | 6 | 5 | 4 | 3 | 2 | 1 | 0 | 0x00 | Yes |

ADT7466

REGISTER DETAILS

Configuration 1

Table 31. Register 0x00— Configuration Register 1 (Power-On Default = 0x01)

| Bit No. | Name | Read/Write | Description |
|---------|-----------------|------------|--|
| 0 | STRT | Read/Write | Logic 1 enables monitoring, and PWM control outputs based on the limit settings programmed. Logic 0 disables monitoring and PWM control based on the default power-up limit settings. The limit values programmed are preserved even if a Logic 0 is written to this bit and the default settings are enabled. This bit becomes read only and cannot be changed once Bit 1 (LOCK bit) is written. All limit registers should be programmed by BIOS before setting this bit to 1. Lockable. |
| 1 | LOCK | Write Once | Logic 1 locks all limit values to their current settings. Once this bit is set, all lockable registers become read only and cannot be modified until the ADT7466 is powered down and powered up again. This prevents rogue programs such as viruses from modifying critical system limit settings. Lockable. |
| 2 | RDY | Read Only | This bit is set to 1 by the ADT7466 to indicate that the device is fully powered up and ready to begin systems monitoring. |
| 3 | FSPD | Read/Write | When this bit is 1, it runs all fans at full speed. Power-on default is 0. This bit is not locked at any time. |
| 4 | FSPDIS | Read/Write | Logic 1 disables fan spin-up for two tach pulses. Instead, the DAC outputs go high for the entire fan spin-up timeout selected. |
| 5 | TODIS | Read/Write | When this bit is 1, the SMBus timeout feature is disabled. This allows the ADT7466 to be used with SMBus controllers that cannot handle SMBus timeouts. Lockable. |
| 6 | V _{CC} | Read/Write | When this bit is 1, the ADT7466 rescales its V _{CC} pin to measure a 5 V supply. When this bit is 0, the ADT7466 measures V _{CC} as a 3.3 V supply. Lockable. |
| 7 | OBIN | Read/Write | When this bit is 0 (default) temperature data format is binary. When this bit is 1, format is offset binary. |

Configuration 2

This register becomes read only when the Configuration Register 1 lock bit is set to 1. Additional attempts to write to this register have no effect.

Table 32. Register 0x01— Configuration Register 2 (Power-On Default = 0x00)

| Bit No. | Name | Read/Write | Description |
|---------|--------|------------|--|
| 0 | RTYPE | Read/Write | When this bit is cleared (default), thermistor normalization is optimized for 100 kΩ thermistors. When this bit is set, it is optimized for 10 kΩ thermistors. |
| 1 | CURR | Read/Write | This bit sets the thermal diode current. It should be left at 0. |
| 2 | REFZ | Read/Write | Setting this bit makes the REFOUT pin high impedance. |
| 3 | Unused | – | Unused. Write ignored. Reads back 0. |
| 4 | AVG | Read/Write | When AVG is 1, averaging on the temperature and voltage measurements is turned off. This allows measurements on each channel to be made much faster. |
| 5 | RATE | Read/Write | If averaging is turned off and measurement set to single channel mode, the RATE bit sets the conversion rate. 0 = 32 conversions/second; 1 = 4 conversions/second. |
| 6 | SHDN | Read/Write | When SHDN is 1, the ADT7466 goes into shutdown mode. Both DAC outputs are set to 0 V to switch off both fans. The DAC registers read back 0x00 to indicate that the fans are not being driven. |
| 7 | REM2 | Read/Write | Setting this bit configures AIN1 and AIN2 for connection of a second thermal diode. Setting this bit overrides THER1 and THER2 in Configuration Register 3. |

Configuration 3

This register becomes read only when the Configuration Register 1 lock bit is set to 1. Additional attempts to write to this register have no effect. Bits 4:5 are not locked.

Table 33. Register 0x02—Configuration Register 3 (Power-On Default = 0xC0)

| Bit No. | Name | Read/Write | Description |
|---------|----------|------------|---|
| 1:0 | P7CONFIG | Read/Write | These bits configure Pin 7 as either FAN1_ON output, $\overline{\text{THERM}}$ output or $\overline{\text{PROCHOT}}$ input. 00 = FAN1_ON output 01 = $\overline{\text{THERM}}$ output 1X = $\overline{\text{PROCHOT}}$ input |
| 2 | BOOST | Read/Write | When BOOST is set to 1, assertion of $\overline{\text{PROCHOT}}$ causes all fans to run at 100% duty cycle for fail safe cooling. |
| 3 | FAST | Read/Write | Setting this bit to 1 enables fast tach measurements on all channels. This increases the tach measurement rate from once a second, to one every 250 ms (4x). |
| 4 | DC1 | Read/Write | Setting this bit to 1 enables tach measurements to be continuously made on TACH1. Not lockable. |
| 5 | DC2 | Read/Write | Setting this bit to 2 enables tach measurements to be continuously made on TACH2. Not lockable. |
| 6 | THER2 | Read/Write | Setting this bit to 1 configures AIN1 as a thermistor input. Setting this bit to 0 configures for analog input. |
| 7 | THER1 | Read/Write | Setting this bit to 1 configures AIN2 as a thermistor input. Setting this bit to 0 configures for analog input. |

Configuration Register 4

Table 34. Register 0x03—Configuration Register 4 (Power-On Default = 0x00)

| Bit No. | Name | R/W | Description |
|---------|--------|------------|--|
| 2:0 | CH2:0 | Read/Write | These bits select the input channel when SNGL bit is set. 011 = Remote 1 temperature 100 = Local temperature 101 = Remote 2 temperature |
| 3 | SNGL | Read/Write | Setting this bit selects single channel measurement. |
| 4 | MIN1 | Read/Write | When this bit is set, Fan 1 never goes below minimum speed setting. |
| 5 | MIN2 | Read/Write | When this bit is set, Fan 2 never goes below minimum speed setting. |
| 6 | Unused | Read only | Unused. Write ignored. Reads back 0. |
| 7 | Unused | Read only | Unused. Write ignored. Reads back 0. |

AFC1 Configuration

If more than one of Bits 0:3 are set, the fan speed is controlled by whichever temperature channel demands the highest fan speed.

Table 35. Register 0x05—AFC Configuration Register 1 (Power-On Default = 0x0C)

| Bit No. | Name | Read/Write | Description |
|---------|----------|------------|---|
| 0 | TH1/REM2 | Read/Write | When this bit is set, Fan 1 speed is controlled by TH1 if Pin 11 is configured for thermistor, or by Thermal Diode 2 if Pin 11 is configured for thermal diode. |
| 1 | TH2 | Read/Write | When this bit is set, Fan 1 speed is controlled by TH2 if Pin 12 is configured for thermistor. |
| 2 | REM1 | Read/Write | When this bit is set, Fan 1 speed is controlled by Remote Temperature Input 1. |
| 3 | LOC | Read/Write | When this bit is set, Fan 1 speed is controlled by local temperature input. |
| 4 | MAN | Read/Write | When this bit is set, Fan 1 speed is under user control by writing directly to the DRIVE1 register. This overrides all lower bit settings |
| 5 | MIN | Read/Write | When this bit is set, Fan 1 runs at minimum speed. This overrides all lower bit settings. |
| 6 | STRT | Read/Write | When this bit is set, Fan 1 runs at start-up speed. This overrides all lower bit settings. |
| 7 | MAX | Read/Write | When this bit is set, Fan 1 runs at maximum speed. This overrides all lower bit settings. |

ADT7466

AFC2 Configuration

If more than one of Bits 0:3 are set, the fan speed is controlled by whichever temperature channel demands the highest fan speed.

Table 36. Register 0x06—AFC Configuration Register 2 (Power-On Default = 0x0C)

| Bit No. | Name | Read/Write | Description |
|---------|----------|------------|---|
| 0 | TH1/REM2 | Read/Write | When this bit is set, Fan 2 speed is controlled by TH1 if Pin 11 is configured for thermistor, or by Thermal Diode 2 if Pin 11 is configured for thermal diode. |
| 1 | TH2 | Read/Write | When this bit is set, Fan 2 speed is controlled by TH2 if Pin 12 is configured for thermistor. |
| 2 | REM1 | Read/Write | When this bit is set, Fan 2 speed is controlled by Remote Temperature Input 1. |
| 3 | LOC | Read/Write | When this bit is set, Fan 2 speed is controlled by the local temperature input. |
| 4 | MAN | Read/Write | When this bit is set, Fan 2 speed is under user control by writing directly to the DRIVE2 register. This overrides all lower bit settings. |
| 5 | MIN | Read/Write | When this bit is set, Fan 2 runs at minimum speed. This overrides all lower bit settings. |
| 6 | STRT | Read/Write | When this bit is set, Fan 2 runs at startup speed. This overrides all lower bit settings. |
| 6 | MAX | Read/Write | When this bit is set, Fan 2 runs at maximum speed. This overrides all lower bit settings. |

Extended Resolution 1

Table 37. Register 0x08—Extended Resolution Register 1 (Power-On Default = 0x00)

| Bit No. | Name | Read/Write | Description |
|---------|--------|------------|--------------------------------------|
| 0 | REM0 | Read only | LSB of remote temperature reading. |
| 1 | REM1 | Read only | Bit 1 of remote temperature reading. |
| 2 | VCC0 | Read only | LSB of V _{CC} reading. |
| 3 | VCC1 | Read only | Bit 1 of V _{CC} reading. |
| 4 | AIN2-0 | Read only | LSB of AIN2 reading. |
| 5 | AIN2-1 | Read only | Bit 1 of AIN2 reading. |
| 6 | AIN1-0 | Read only | LSB of AIN1 reading. |
| 7 | AIN1-1 | Read only | Bit 1 of AIN1 reading. |

Extended Resolution 2

Table 38. Register 0x09—Extended Resolution Register 2 (Power-On Default = 0x00)

| Bit No. | Name | Read/Write | Description |
|---------|--------|------------|-------------------------------------|
| 0 | LOC0 | Read only | LSB of local temperature reading. |
| 1 | LOC1 | Read only | Bit 1 of local temperature reading. |
| 2 | Unused | Read only | Not used. Reads back 0. |
| 3 | Unused | Read only | Not used. Reads back 0. |
| 4 | Unused | Read only | Not used. Reads back 0. |
| 5 | Unused | Read only | Not used. Reads back 0. |
| 6 | Unused | Read only | Not used. Reads back 0. |
| 7 | Unused | Read only | Not used. Reads back 0. |

Voltage Reading

If the extended resolution bits of these readings are also being read, Extended Resolution Register 1 (0x08) should be read first. Once the extended resolution register is read, it and the associated MSB reading registers are frozen until read.

Table 39. Voltage Reading Registers (Power-On Default = 0x00)

| Register Address | Read/Write | Description |
|------------------|------------|--|
| 0x0A | Read only | AIN1(TH1)/REM2 reading (8 MSBs of reading). |
| 0x0B | Read only | AIN2(TH2) reading (8 MSBs of reading). |
| 0x0C | Read only | V _{CC} reading. Measures V _{CC} through the V _{CC} pin (8 MSBs of reading). |

Temperature Reading

If the extended resolution bits of these readings are also being read, the extended resolution registers (0x08, 0x09) should be read first. Once the extended resolution register gets read, all associated MSB reading registers get frozen until read. Both the extended resolution register and the MSB registers are frozen.

Table 40. Temperature Reading Registers (Power-On Default = 0x00)

| Register Address | Read/Write | Description |
|------------------|------------|---|
| 0x0D | Read only | Remote Temperature 1 reading (8 MSBs of reading). |
| 0x0E | Read only | Local temperature reading (8 MSBs of reading). |

PROCHOT

Table 41. Register 0x0F—PROCHOT Register (Power-On Default = 0x00)

| Bit No. | Name | Read/Write | Description |
|---------|-----------|------------|--|
| 7:1 | TMR | Read only | Times for how long $\overline{\text{THERM}}$ input is asserted. These 7 bits read 0 until the $\overline{\text{PROCHOT}}$ assertion time exceeds 45.52 ms. |
| 0 | ASRT/TMR0 | Read only | Set high on the assertion of the $\overline{\text{THERM}}$ input. Cleared on read. If the $\overline{\text{PROCHOT}}$ assertion time exceeds 45.52 ms, this bit is set and becomes the LSB of the 8-bit TMR reading. This allows $\overline{\text{PROCHOT}}$ assertion times from 45.52 ms to 5.82 seconds to be reported back with a resolution of 22.76 ms. |

Interrupt Status 1

Table 42. Register 0x10—Interrupt Status Register 1 (Power-On Default = 0x00)

| Bit No. | Name | Read/Write | Description |
|---------|-----------------|------------|--|
| 0 | FAN2 | Read only | Setting this bit to 1 indicates that Fan 2 has dropped below minimum speed or has stalled. This bit is not set when the DRIVE2 output is off. |
| 1 | FAN1 | Read only | Setting this bit to 1 indicates that Fan 1 has dropped below minimum speed or has stalled. This bit is not set when the DRIVE1 output is off. |
| 2 | LOC | Read only | Setting this bit to 1 indicates that the local temperature reading is out of limit. This bit is cleared on a read of the status register only if the error condition clears. |
| 3 | REM1 | Read only | Setting this bit to 1 indicates that Remote Temperature 1 reading is out of limit. This bit is cleared on a read of the status register only if the error condition clears. |
| 4 | V _{cc} | Read only | Setting this bit to 1 indicates that the V _{cc} reading is out of limit. This bit is cleared on a read of the status register only if the error condition clears. |
| 5 | AIN2(TH2) | Read only | Setting this bit to 1 indicates that the AIN2(TH2) reading is out of limit. This bit is cleared on a read of the status register only if the error condition clears. |
| 6 | AIN1(TH1)/REM2 | Read only | Setting this bit to 1 indicates that the AIN1(TH1)/REM2 reading is out of limit. This bit is cleared on a read of the status register only if the error condition clears. |
| 7 | OOL | Read only | Setting this bit to 1 indicates that an out-limit event is latched in Status Register 2. This bit is a logical OR of all status bits in Status Register 2. Software can test this bit in isolation to determine whether any of the voltage, temperature, or fan speed readings represented by Status Register 2 are out of limit. This saves the need to read Status Register 2 during every interrupt or polling cycle. |

ADT7466

Interrupt Status 2

Table 43. Register 0x11—Interrupt Status Register 2 (Power-On Default = 0x00)

| Bit No. | Name | Read/Write | Description |
|---------|--------|------------|--|
| 0 | OVT | Read only | Setting this bit to 1 indicates that one of the $\overline{\text{THERM}}$ overtemperature limits has been exceeded. This bit is cleared automatically when the temperature drops below $\overline{\text{THERM}} - T_{\text{HYST}}$. |
| 1 | PHOT | Read only | If Pin 7 is configured as the input for $\overline{\text{PROCHOT}}$ monitoring, this bit is set when the $\overline{\text{PROCHOT}}$ assertion time exceeds the limit programmed in the $\overline{\text{PROCHOT}}$ limit register (0x1E). |
| 2 | D1 | Read only | Setting this bit to 1 indicates either an open or a short circuit on the Thermal Diode 1 inputs. |
| 3 | D2 | Read only | Setting this bit to 1 indicates either an open or a short circuit on the Thermal Diode 2 inputs. |
| 4 | TH1 | Read only | Setting this bit to 1 indicates either an open or a short circuit on the TH1 input. |
| 5 | TH2 | Read only | Setting this bit to 1 indicates either an open or a short circuit on the TH2 input. |
| 6 | Unused | Read only | Not used. Reads back 0. |
| 7 | Unused | Read only | Not used. Reads back 0. |

Interrupt Mask 1

Table 44. Register 0x12—Interrupt Mask Register 1 (Power-On Default = 0x00)

| Bit No. | Name | Read/Write | Description |
|---------|-------------------|------------|--|
| 0 | FAN2 | Read only | Setting this bit masks the Fan 2 interrupt from the $\overline{\text{ALERT}}$ output. |
| 1 | FAN1 | Read only | Setting this bit masks the Fan 1 interrupt from the $\overline{\text{ALERT}}$ output. |
| 2 | LOC | Read only | Setting this bit masks the local temperature. interrupt from the $\overline{\text{ALERT}}$ output. |
| 3 | REM | Read only | Setting this bit masks the remote temperature interrupt from the $\overline{\text{ALERT}}$ output. |
| 4 | V _{CC} | Read only | Setting this bit masks the V _{CC} interrupt from the $\overline{\text{ALERT}}$ output. |
| 5 | AIN2(TH2) | Read only | Setting this bit masks the AIN2(TH2) interrupt from the $\overline{\text{ALERT}}$ output. |
| 6 | AIN1 /TH1/REM2 | Read only | Setting this bit masks the AIN1(TH1)/REM2 interrupt from the $\overline{\text{ALERT}}$ output. |
| 7 | OOL | Read only | Setting this bit masks the OOL interrupt from the $\overline{\text{ALERT}}$ output. |

Interrupt Mask 2

Table 45. Register 0x13—Interrupt Mask Register 2 (Power-On Default = 0x00)

| Bit No. | Name | Read/Write | Description |
|---------|--------|------------|---|
| 0 | OVT | Read only | Setting this bit masks the $\overline{\text{OVT}}$ interrupt from $\overline{\text{ALERT}}$ output. |
| 1 | PHOT | Read only | Setting this bit masks the $\overline{\text{THERM}}$ interrupt from $\overline{\text{ALERT}}$ output. |
| 2 | D1 | Read only | Setting this bit masks the Thermal Diode 1 fault interrupt from $\overline{\text{ALERT}}$ output. |
| 3 | D2 | Read only | Setting this bit masks Thermal Diode 2 fault interrupt from $\overline{\text{ALERT}}$ output. |
| 4 | TH1 | Read only | Setting this bit masks the TH1 fault interrupt from $\overline{\text{ALERT}}$ output. |
| 5 | TH2 | Read only | Setting this bit masks the TH2 fault interrupt from $\overline{\text{ALERT}}$ output. |
| 6 | Unused | Read only | Not used. Reads back 0. |
| 7 | Unused | Read only | Not used. Reads back 0. |

Voltage Limit

Setting the Configuration Register 1 lock bit has no effect on these registers.

High limits: An interrupt is generated when a value exceeds its high limit (> comparison).

Low limits: An interrupt is generated when a value is equal to or below its low limit (\leq comparison).

Table 46. Voltage Limit Registers

| Register Address | Read/Write | Description | Power-On Default |
|------------------|------------|-----------------------------|------------------|
| 0x14 | Read/Write | AIN1(TH1)/REM2 low limit. | 0x00 |
| 0x15 | Read/Write | AIN1(TH1)/REM2 high limit. | 0xFF |
| 0x16 | Read/Write | AIN2(TH2) low limit. | 0x00 |
| 0x17 | Read/Write | AIN2(TH2) high limit. | 0xFF |
| 0x18 | Read/Write | V _{CC} low limit. | 0x00 |
| 0x19 | Read/Write | V _{CC} high limit. | 0xFF |

Temperature Limit

Setting the Configuration Register 1 lock bit has no effect on these registers. When the temperature readings are in offset binary format, an offset of 64 degrees (0x40 or 0100000) must be added to all temperature and THERM limits. For example, if the limit is 50°C the actual programmed limit is 114.

High limits: An interrupt is generated when a value exceeds its high limit (> comparison).

Low limits: An interrupt is generated when a value is equal to or below its low limit (\leq comparison).

Table 47. Temperature Limit Registers

| Register Address | Read/Write | Description | Power-On Default |
|------------------|------------|----------------------------------|------------------|
| 0x1A | Read/Write | Remote 1 Temperature low limit. | 0x00 |
| 0x1B | Read/Write | Remote 1 Temperature high limit. | 0x7F |
| 0x1C | Read/Write | Local temperature low limit. | 0x00 |
| 0x1D | Read/Write | Local temperature high limit. | 0x7F |

PROCHOT Limit

This is an 8-bit limit with a resolution of 22.76 ms allowing PROCHOT assertion limits of 45.52 ms to 5.82 seconds to be programmed. If the PROCHOT assertion time exceeds this limit, Bit 1 of Interrupt Status Register 2 (0x11) is set. If the limit value is 0x00, an interrupt is generated immediately upon assertion of the THERM input.

Table 48. Register 0x1E—PROCHOT Limit Register (Power-On Default = 0x00)

| Bit No. | Name | Read/Write | Description |
|---------|-------|------------|--|
| 7:0 | LIMIT | Read/Write | Sets maximum <u>PROCHOT</u> assertion length allowed before an interrupt is generated. |

ADT7466

THERM Limit

If any temperature measured exceeds its THERM limit, both DRIVE outputs drive their fans at maximum output. This is a failsafe mechanism incorporated to cool the system in the event of a critical overtemperature. It also ensures some level of cooling in the event that software or hardware locks up. If set to 0x00, this feature is disabled. The DRIVE output remains at 0xFF until the temperature drops below THERM limit – hysteresis. If the THERM pin is programmed as an output, exceeding these limits by 0.25°C can cause the THERM pin to assert low as an output.

These registers become read only when the Configuration Register 1 lock bit is set to 1. Additional attempts to write to these registers have no effect.

Table 49. THERM Limit Registers

| Register Address | Read/Write | Description | Power-On Default |
|------------------|------------|----------------------------|------------------|
| 0x1F | Read/Write | AIN1/TH1/REM2 THERM limit. | 0x64 (100°C) |
| 0x20 | Read/Write | AIN2(TH2) THERM limit. | 0x64 (100°C) |
| 0x21 | Read/Write | Remote 1 THERM limit. | 0x64 (100°C) |
| 0x22 | Read/Write | Local THERM limit. | 0x64 (100°C) |

Temperature Offset

These registers contain an 8-bit, twos complement offset value that is automatically added to or subtracted from the temperature reading to compensate for any systematic errors such as those caused by noise pickup. LSB value = 1°C.

This register becomes read only when the Configuration Register 1 lock bit is set to 1. Additional attempts to write to this register have no effect.

Table 50. Temperature Offset Registers

| Register Address | Read/Write | Description | Power-On Default |
|------------------|------------|------------------------|------------------|
| 0x24 | Read/Write | AIN1(TH1)/REM2 offset. | 0x00 |
| 0x25 | Read/Write | AIN2(TH2) offset. | 0x00 |
| 0x26 | Read/Write | Remote 1 offset. | 0x00 |
| 0x27 | Read/Write | Local offset. | 0x00 |

TMIN

These registers contain the TMIN temperatures for automatic fan control (AFC). These are the temperatures above which the fan starts to operate. The data format is either binary or offset binary, the same as the temperature reading, depending on which option is chosen by setting or clearing Bit 7 of Configuration Register 1.

These registers become read only when the Configuration Register 1 lock bit is set to 1. Additional attempts to write to these registers have no effect.

Table 51. TMIN Registers

| Register Address | Read/Write | Description | Power-On Default |
|------------------|------------|-----------------------------------|------------------|
| 0x28 | Read/Write | AIN1(TH1)/REM2 T _{MIN} . | 0x5A (90°C) |
| 0x29 | Read/Write | AIN2(TH2) T _{MIN} . | 0x5A (90°C) |
| 0x2A | Read/Write | Remote 1 T _{MIN} . | 0x5A (90°C) |
| 0x2B | Read/Write | Local T _{MIN} . | 0x5A (90°C) |

Table 52. TMIN Codes

| Temperature | Binary | Offset Binary |
|-------------|------------|---------------|
| -64°C | 0 000 0000 | 0 000 0000 |
| 0°C | 0 000 0000 | 0 100 0000 |
| 1°C | 0 000 0001 | 0 100 0001 |
| 10°C | 0 000 1010 | 0 100 1010 |
| 25°C | 0 001 1001 | 0 101 1001 |
| 50°C | 0 011 0010 | 0 111 0010 |
| 75°C | 0 100 1011 | 1 000 1011 |
| 100°C | 0 110 0100 | 1 010 0100 |
| 125°C | 0 111 1101 | 1 011 1101 |
| 127°C | 0 111 1111 | 1 011 1111 |
| 191°C | 0 111 1111 | 1 111 1111 |

THT Range

Table 53. Register 0x2C—THTRANGE Register (Power-On Default = 0xCC)

| Bit No. | Name | Read/Write | Description |
|---------|------|------------|---|
| 3:0 | TH2R | Read/Write | These bits set the temperature range over which AFC operates for the TH2 input. The fan starts operating at T_M and reaches full speed at $T_M + T_R$ (where T_M is the temperature set by the TMIN code, and T_R is the temperature range set by the TRANGE code). |
| 7:4 | TH1R | Read/Write | These bits set the temperature range over which AFC operates for the TH1 or REM2 input. The fan starts operating at T_M and reaches full speed at $T_M + T_R$ (where T_M is the temperature set by the TMIN code, and T_R is the temperature range set by the TRANGE code). |

Remote and Local TRANGE

Table 54. Register 0x2D—Remote and Local TRANGE Register (Power-On Default = 0xCC)

| Bit No. | Name | Read/Write | Description |
|---------|------|------------|---|
| 3:0 | LOR | Read/Write | These bits set the temperature range over which AFC operates for the local temperature input. The fan starts operating at T_M and reaches full speed at $T_M + T_R$ (where T_M is the temperature set by the TMIN code, and T_R is the temperature ranges set by the TRANGE code). |
| 7:4 | RMR | Read/Write | These bits set the temperature range over which AFC operates for the Remote 1 (D1) temperature input. The fan starts operating at T_M and reaches full speed at $T_M + T_R$ (where T_M is the temperature set by the TMIN code, and T_R is the temperature range set by the TRANGE code). |

Table 55. TRANGE Codes

| Bits 7:4 or 3:0 | TRANGE |
|-----------------|----------------|
| 0000 | 2°C |
| 0001 | 2.5°C |
| 0010 | 3.33°C |
| 0011 | 4°C |
| 0100 | 5°C |
| 0101 | 6.67°C |
| 0110 | 8°C |
| 0111 | 10°C |
| 1000 | 13.33°C |
| 1001 | 16°C |
| 1010 | 20°C |
| 1011 | 26.67°C |
| 1100 | 32°C (default) |
| 1101 | 40°C |
| 1110 | 53.33°C |
| 1111 | 80°C |

ADT7466

TH1/TH2 Hysteresis

Table 56. Register 0x2E—TH1/TH2 Hysteresis Register (Power-On Default = 0x44)

| Bit No. | Name | Read/Write | Description |
|---------|-------|------------|--|
| 7:4 | TH1TH | Read/Write | This nibble contains the temperature hysteresis value for TH1/REM2. 0x0 = 0°C to 0xF = 15°C. |
| 3:0 | TH2TH | Read/Write | This nibble contains the temperature hysteresis value for TH2. 0x0 = 0°C to 0xF = 15°C. |

REM/LOC Hysteresis

Table 57. Register 0x2F—REM/LOC Hysteresis Register (Power-On Default = 0x44)

| Bit No. | Name | Read/Write | Description |
|---------|------|------------|--|
| 7:4 | RM1H | Read/Write | This nibble contains the temperature hysteresis value for remote temperature input. 0x0 = 0°C to 0xF = 15°C. |
| 3:0 | LOH | Read/Write | This nibble contains the temperature hysteresis value for local temperature input. 0x0 = 0°C to 0xF = 15°C. |

Fan Start-Up Voltage

This is the voltage output from the fan drive output for two tach periods after it first starts up. Taking gain into account, the fan drive amplifier should be chosen so the voltage applied to the fan is sufficiently high to ensure that the fan starts.

Table 58. Fan Start-Up Voltage Registers (Power-On Default = 0x80)

| Register Address | Read/Write | Description |
|------------------|------------|-------------------------|
| 0x30 | Read/Write | Fan 1 start-up voltage. |
| 0x31 | Read/Write | Fan 2 start-up voltage. |

Fan Maximum Voltage

This is the minimum voltage output from the fan drive output after the fan spins up, in the absence of any other speed control input.

Table 59. Fan Minimum Voltage Registers (Power-On Default = 0x60)

| Register Address | Read/Write | Description |
|------------------|------------|------------------------|
| 0x32 | Read/Write | Fan 1 minimum voltage. |
| 0x33 | Read/Write | Fan 2 minimum voltage. |

Fan Maximum RPM

This is the maximum RPM that the fan can run at in AFC mode.

Table 60. Fan Maximum RPM Registers (Power-On Default = 0x20)

| Register Address | Read/Write | Description |
|------------------|------------|--------------------|
| 0x34 | Read/Write | Fan 1 maximum RPM. |
| 0x35 | Read/Write | Fan 2 maximum RPM. |

Enhanced Acoustics

Table 61. Register 0x36—Enhanced Acoustics Register (Power-On Default = 0x3F)

| Bit No. | Name | Read/Write | Description |
|------------|--------------------------------------|--------------------------|---|
| 2:0 5:3 | FAN1 Step FAN2 Step | Read/Write Read/Write | These bits set the step size by which the DRIVE1 and DRIVE2 PWM output duty-cycle can change when enhance acoustics mode is selected. 000 = 1 bit 001 = 2 bits 010 = 3 bits 011 = 5 bits 100 = 8 bits 101 = 12 bits 110 = 24 bits 111 = 48 bits |
| 6 | Enable Fan1 Enhanced Acoustics | Read/Write | When this bit is set to 1, enhanced acoustics are enabled for Fan 1. |
| 7 | Enable Fan2 Enhanced Acoustics | Read/Write | When this bit is set to 1, enhanced acoustics are enabled for Fan 2. |

Fault Increment

Table 62. Register 0x37—Fault Increment Register (Power-On Default = 0x3F)

| Bit No. | Name | Read/Write | Description |
|------------|-------------------------|--------------------------|---|
| 2:0 5:3 | FAN1Fault FAN2 Fault | Read/Write Read/Write | These bits set the step size by which the DRIVE1 and DRIVE2 PWM output duty-cycle can change in fan fault mode. 000 = 1 bit 001 = 2 bits 010 = 3 bits 011 = 5 bits 100 = 8 bits 101 = 12 bits 110 = 24 bits 111 = 48 bits |
| 7:6 | Unused | – | Unused. Write ignored. Reads back 0. |

Start-Up Timeout Configuration

Table 63. Register 0x38—Start-Up Timeout Configuration Register (Power-On Default = 0x00)

| Bit No. | Name | Read/Write | Description |
|------------|------------|--------------------------|--|
| 2:0 5:3 | ST1 ST2 | Read/Write Read/Write | These bits set the start-up timeout for Fan 1. These bits set the start-up timeout for Fan 2. 000 = No start-up timeout 001 = 100 ms 010 = 250 ms 011 = 400 ms 100 = 667 ms 101 = 1second 110 = 2 seconds 111 = 4 seconds |
| 7:6 | Unused | – | Unused. Write ignored. Reads back 0. |

ADT7466

Fan Pulses Per Revolution

Table 64. Register 0x39—Fan Pulses Per Revolution Register (Power-On Default = 0x05)

| Bit No. | Name | Read/Write | Description |
|---------|--------|------------|---|
| 1:0 | FAN1 | Read/Write | Sets number of pulses to be counted when measuring FAN1 speed. Can be used to determine fan's pulses per revolution number for unknown fan type. Pulses Counted 00 = 1 01 = 2 (default) 10 = 3 11 = 4 |
| 3:2 | FAN2 | Read/Write | Sets number of pulses to be counted when measuring FAN2 speed. Can be used to determine fan's pulses per revolution number for unknown fan type. Pulses Counted 00 = 1 01 = 2 (default) 10 = 3 11 = 4 |
| 7:4 | Unused | – | Unused. Write ignored. Reads back 0. |

Information Registers

Table 65. Register 0x3D—Device ID Register (Power-On Default = 0x66)

| Bit No. | Name | Read/Write | Description |
|---------|----------|------------|----------------------------|
| 7:0 | Reserved | Read only | Contains device ID number. |

Table 66. Register 0x3E—Company Id Register (Power-On Default = 0x41)

| Bit No. | Name | Read/Write | Description |
|---------|----------|------------|-----------------------------|
| 7:0 | Reserved | Read only | Contains company ID number. |

Table 67. Register 0x3F—Revision Number Register (Power-On Default = 0x02)

| Bit No. | Name | Read/Write | Description |
|---------|----------|------------|---------------------------------|
| 7:0 | Reserved | Read only | Contains device revision level. |

Fan Drive (DAC)

These registers reflect the drive value of each fan at any given time. When in automatic fan speed control mode, the ADT7466 reports the drive values back through these registers. The fan drive values vary according to temperature in automatic fan speed control mode. During fan startup, these registers report 0x00. In software mode, the fan drive outputs can be set to any value by writing to these registers.

Table 68. Fan Drive (DAC) Registers (Power-On Default = 0x00)

| Register Address | Read/Write | Description |
|------------------|------------|------------------------------------|
| 0x40 | Read/Write | DRIVE1, Current Fan 1 drive value. |
| 0x41 | Read/Write | DRIVE2, Current Fan 2 drive value. |

XOR Tree Test Enable

This register becomes read only when the Configuration Register 1 lock bit is set to 1. Additional attempts to write to this register have no effect.

Table 69. Register 0x42—XOR Tree Test Enable (Power-On Default = 0x00)

| Bit No. | Name | Read/Write | Description |
|---------|----------|------------|---|
| 7:1 | Reserved | – | Unused. Do not write to these bits. |
| 0 | XEN | Read/Write | If the XEN bit is set to 1, the device enters the XOR tree test mode. Clearing the bit removes the device from the XOR test mode. |

Fan Tachometer Reading

These registers count the number of 12.43 μ s periods (based on a local 82 kHz clock) that occur between a number of consecutive fan tach pulses (default = 2). The number of tach pulses used to count can be changed by using the fan pulses per revolution register (0x39). This allows the fan speed to be accurately measured. Since a valid fan tachometer reading requires two bytes to be read, the low byte must be read first. Both the low and high bytes are then frozen until read. At power-on, these registers contain 0x0000 until such time as the first valid fan tach measurement is read into these registers. This prevents false interrupts from occurring while the fans are spinning up.

A count of 0xFFFF indicates that a fan is

- Stalled or blocked (object jamming the fan).
- Failed (internal circuitry destroyed).
- Not populated (the ADT7466 expects to see a fan connected to each tach. If a fan is not connected to that tach, its tach minimum high and low byte should be set to 0xFFFF).
- 2-wire instead of 3-wire.

Table 70. Fan Tachometer Reading Registers (Power-On Default = 0xFF)

| Register Address | Read/Write | Description |
|------------------|------------|-----------------|
| 0x48 | Read only | TACH1 low byte |
| 0x49 | Read only | TACH1 high byte |
| 0x4A | Read only | TACH2 low byte |
| 0x4B | Read only | TACH2 high byte |

Fan Tachometer Limit

Exceeding any of the tach limit registers by 1 indicates that the fan is running too slowly or has stalled. The appropriate status bit is set in Interrupt Status Register 1 to indicate the fan failure. Setting the Configuration Register 1 lock bit has no effect on these registers.

Table 71. Fan Tachometer Limit Registers (Power-On Default = 0xFF)

| Register Address | Read/Write | Description |
|------------------|------------|--------------------------|
| 0x4C | Read/Write | TACH 1 minimum low byte |
| 0x4D | Read/Write | TACH 1 minimum high byte |
| 0x4E | Read/Write | TACH 2 minimum low byte |
| 0x4F | Read/Write | TACH 2 minimum high byte |

Manufacturer's Test

These registers are for manufacturer's use only and should not be read or written to in normal use.

These registers become read only when the Configuration Register 1 lock bit is set to 1. Additional attempts to write to these register have no effect.

Table 72. Register 0x3F—Manufacturers Test Registers (Power-On Default = 0x00)

| Register Address | Read/Write | Description |
|------------------|------------|--------------------------------|
| 0x50 | Read/Write | Manufacturer's Test Register 1 |
| 0x51 | Read/Write | Manufacturer's Test Register 2 |
| 0x52 | Read/Write | Manufacturer's Test Register 3 |
| 0x53 | Read/Write | Manufacturer's Test Register 4 |

OUTLINE DIMENSIONS

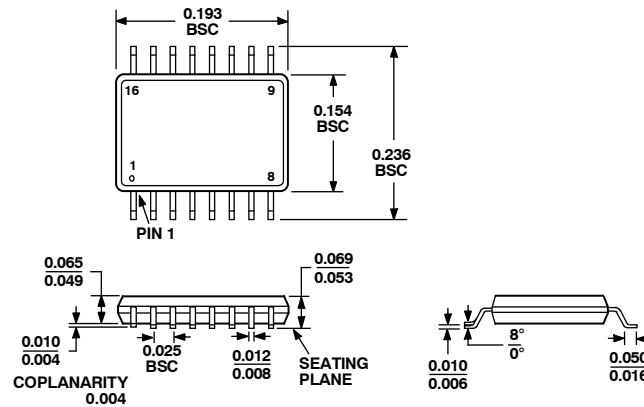



Figure 46. 16-Lead Shrink Small Outline Package [QSOP] (RQ-16)

Dimensions shown in inches

ORDERING GUIDE

| Model | Temperature Range | Package Description | Package Option |
|--------------------------------|-------------------|---------------------|----------------|
| ADT7466ARQ Z ¹ | -40°C to +125°C | 16-Lead QSOP | RQ-16 |
| ADT7466ARQ Z-REEL ¹ | -40°C to +125°C | 16-Lead QSOP | RQ-16 |
| ADT7466ARQ Z-RL7 ¹ | -40°C to +125°C | 16-Lead QSOP | RQ-16 |
| EVAL-ADT7466EB | | Evaluation Board | |

¹ Z = Pb-free part.

ON Semiconductor and  are registered trademarks of Semiconductor Components Industries, LLC (SCILLC). SCILLC reserves the right to make changes without further notice to any products herein. SCILLC makes no warranty, representation or guarantee regarding the suitability of its products for any particular purpose, nor does SCILLC assume any liability arising out of the application or use of any product or circuit, and specifically disclaims any and all liability, including without limitation special, consequential or incidental damages. "Typical" parameters which may be provided in SCILLC data sheets and/or specifications can and do vary in different applications and actual performance may vary over time. All operating parameters, including "Typicals" must be validated for each customer application by customer's technical experts. SCILLC does not convey any license under its patent rights nor the rights of others. SCILLC products are not designed, intended, or authorized for use as components in systems intended for surgical implant into the body, or other applications intended to support or sustain life, or for any other application in which the failure of the SCILLC product could create a situation where personal injury or death may occur. Should Buyer purchase or use SCILLC products for any such unintended or unauthorized application, Buyer shall indemnify and hold SCILLC and its officers, employees, subsidiaries, affiliates, and distributors harmless against all claims, costs, damages, and expenses, and reasonable attorney fees arising out of, directly or indirectly, any claim of personal injury or death associated with such unintended or unauthorized use, even if such claim alleges that SCILLC was negligent regarding the design or manufacture of the part. SCILLC is an Equal Opportunity/Affirmative Action Employer. This literature is subject to all applicable copyright laws and is not for resale in any manner.

PUBLICATION ORDERING INFORMATION

LITERATURE FULFILLMENT:
Literature Distribution Center for ON Semiconductor
P.O. Box 5163, Denver, Colorado 80217 USA
Phone: 303-675-2175 or 800-344-3860 Toll Free USA/Canada
Fax: 303-675-2176 or 800-344-3867 Toll Free USA/Canada
Email: orderlit@onsemi.com

N. American Technical Support: 800-282-9855
Toll Free USA/Canada
Europe, Middle East and Africa Technical Support:
Phone: 421 33 790 2910
Japan Customer Focus Center
Phone: 81-3-5773-3850

ON Semiconductor Website: www.onsemi.com
Order Literature: <http://www.onsemi.com/orderlit>
For additional information, please contact your local Sales Representative

Looking for pricing, stock, or lifecycle information?

Click below to explore more details on WIN SOURCE:

- ⊖ [View ADT7466ARQZ-REEL on WIN SOURCE](#)
- ⊖ [ON Semiconductor Information](#)

Optimize Your Supply Chain with WIN SOURCE Solutions

- ✓ Global Sourcing Solution
- ✓ Obsolete Management
- ✓ Cost Control Management
- ✓ Shortage Management
- ✓ Alternative Solution
- ✓ Excess Inventory Management