



**THE DATASHEET OF
NTD20P06L-1G**



NTD20P06L, NTDV20P06L

MOSFET – Power, Single, P-Channel, DPAK –60 V, –15.5 A



ON Semiconductor®

www.onsemi.com

Features

- Withstands High Energy in Avalanche and Commutation Modes
- Low Gate Charge for Fast Switching
- AEC Q101 Qualified – NTDV20P06L
- These Devices are Pb-Free and are RoHS Compliant

Applications

- Bridge Circuits
- Power Supplies, Power Motor Controls
- DC-DC Conversion

$V_{(BR)DSS}$	$R_{DS(on)}$ TYP	I_D MAX (Note 1)
-60 V	130 m Ω @ -5.0 V	-15.5 A

MAXIMUM RATINGS ($T_J = 25^\circ\text{C}$ unless otherwise noted)

Parameter	Symbol	Value	Unit	
Drain-to-Source Voltage	V_{DSS}	-60	V	
Gate-to-Source Voltage	Continuous	V_{GS}	± 20 V	
	Non-Repetitive	$t_p \leq 10$ ms	V_{GSM}	± 30
Continuous Drain Current	Steady State	$T_C = 25^\circ\text{C}$	I_D	-15.5 A
Power Dissipation	Steady State	$T_C = 25^\circ\text{C}$	P_D	65 W
Pulsed Drain Current		$t_p = 10$ μs	I_{DM}	± 50 A
Operating Junction and Storage Temperature	T_J, T_{STG}	-55 to 175	$^\circ\text{C}$	
Single Pulse Drain-to-Source Avalanche Energy ($V_{DD} = 25$ V, $V_{GS} = 5$ V, $I_{PK} = 15$ A, $L = 2.7$ mH, $R_G = 25$ Ω)	E_{AS}	304	mJ	
Lead Temperature for Soldering Purposes (1/8" from case for 10 s)	T_L	260	$^\circ\text{C}$	

THERMAL RESISTANCE RATINGS

Parameter	Symbol	Max	Unit
Junction-to-Case (Drain)	$R_{\theta JC}$	2.3	$^\circ\text{C/W}$
Junction-to-Ambient – Steady State (Note 1)	$R_{\theta JA}$	80	
Junction-to-Ambient – Steady State (Note 2)	$R_{\theta JA}$	110	

Stresses exceeding those listed in the Maximum Ratings table may damage the device. If any of these limits are exceeded, device functionality should not be assumed, damage may occur and reliability may be affected.

1. Surface-mounted on FR4 board using 1 in sq. pad size (Cu area = 1.127 in sq. [1 oz] including traces)
2. Surface-mounted on FR4 board using the minimum recommended pad size (Cu area = 0.412 in sq.)

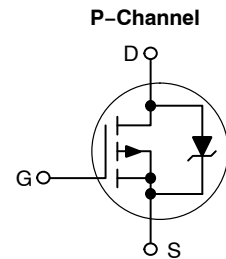

MARKING DIAGRAMS

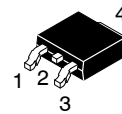

DPAK CASE 369C STYLE 2

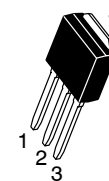
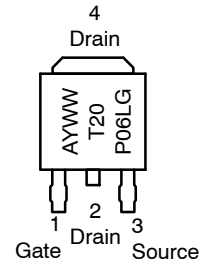

IPAK/DPAK CASE 369D STYLE 2

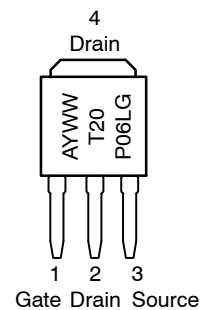

20P06L Device Code
 A = Assembly Location
 Y = Year
 WW = Work Week
 G = Pb-Free Package

ORDERING INFORMATION

See detailed ordering and shipping information in the package dimensions section on page 5 of this data sheet.

NTD20P06L, NTDV20P06L

ELECTRICAL CHARACTERISTICS ($T_J = 25^\circ\text{C}$ unless otherwise noted)

Parameter	Symbol	Test Condition	Min	Typ	Max	Units
OFF CHARACTERISTICS						
Drain-to-Source Breakdown Voltage	$V_{(BR)DSS}$	$V_{GS} = 0\text{ V}, I_D = -250\ \mu\text{A}$	-60	-74		V
Drain-to-Source Breakdown Voltage Temperature Coefficient	$V_{(BR)DSS}/T_J$			-64		mV/°C
Zero Gate Voltage Drain Current	I_{DSS}	$V_{GS} = 0\text{ V}, V_{DS} = -60\text{ V}$	$T_J = 25^\circ\text{C}$		-1.0	μA
			$T_J = 150^\circ\text{C}$		-10	
Gate-to-Source Leakage Current	I_{GSS}	$V_{DS} = 0\text{ V}, V_{GS} = \pm 20\text{ V}$			± 100	nA

ON CHARACTERISTICS (Note 3)

Gate Threshold Voltage	$V_{GS(TH)}$	$V_{GS} = V_{DS}, I_D = -250\ \mu\text{A}$	-1.0	-1.5	-2.0	V
Gate Threshold Temperature Coefficient	$V_{GS(TH)}/T_J$			3.1		mV/°C
Drain-to-Source On Resistance	$R_{DS(on)}$	$V_{GS} = -5.0\text{ V}, I_D = -7.5\text{ A}$		0.130	0.150	Ω
			$V_{GS} = -5.0\text{ V}, I_D = -15\text{ A}$		0.143	
Forward Transconductance	g_{FS}	$V_{DS} = -10\text{ V}, I_D = -7.5\text{ A}$		11		S
Drain-to-Source On-Voltage	$V_{DS(on)}$	$V_{GS} = -5.0\text{ V}, I_D = -7.5\text{ A}$	$T_J = 25^\circ\text{C}$		-1.2	V
			$T_J = 150^\circ\text{C}$		-1.9	

CHARGES AND CAPACITANCES

Input Capacitance	C_{ISS}	$V_{GS} = 0\text{ V}, f = 1\text{ MHz}, V_{DS} = -25\text{ V}$		740	1190	pF
Output Capacitance	C_{OSS}			207	300	
Reverse Transfer Capacitance	C_{RSS}			66	120	
Total Gate Charge	$Q_{G(TOT)}$	$V_{GS} = -5.0\text{ V}, V_{DS} = -48\text{ V}, I_D = -18\text{ A}$		15	26	nC
Gate-to-Source Charge	Q_{GS}			4.0		
Gate-to-Drain Charge	Q_{GD}			7.0		

SWITCHING CHARACTERISTICS (Note 4)

Turn-On Delay Time	$t_{d(ON)}$	$V_{GS} = -5.0\text{ V}, V_{DD} = -30\text{ V}, I_D = -15\text{ A}, R_G = 9.1\ \Omega$		11	20	ns
Rise Time	t_r			90	180	
Turn-Off Delay Time	$t_{d(OFF)}$			28	50	
Fall Time	t_f			70	135	

DRAIN-SOURCE DIODE CHARACTERISTICS

Forward Diode Voltage	V_{SD}	$V_{GS} = 0\text{ V}, I_S = -15\text{ A}$	$T_J = 25^\circ\text{C}$	1.5	2.5	V
			$T_J = 150^\circ\text{C}$	1.3		
Reverse Recovery Time	t_{RR}	$V_{GS} = 0\text{ V}, d_I/d_t = 100\text{ A}/\mu\text{s}, I_S = -12\text{ A}$		60		ns
Charge Time	t_a			39		
Discharge Time	t_b			21		
Reverse Recovery Charge	Q_{RR}			0.13		

3. Pulse Test: pulse width $\leq 300\ \mu\text{s}$, duty cycle $\leq 2\%$
4. Switching characteristics are independent of operating junction temperatures

Product parametric performance is indicated in the Electrical Characteristics for the listed test conditions, unless otherwise noted. Product performance may not be indicated by the Electrical Characteristics if operated under different conditions.

NTD20P06L, NTDV20P06L

TYPICAL PERFORMANCE CURVES

($T_J = 25^\circ\text{C}$ unless otherwise noted)

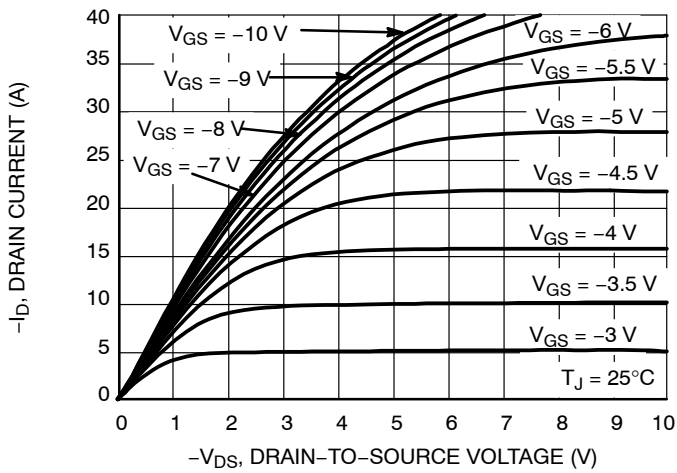

Figure 1. On-Region Characteristics

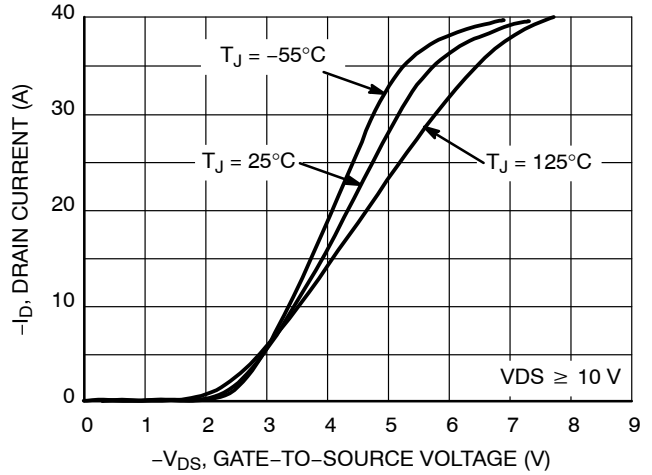

Figure 2. Transfer Characteristics

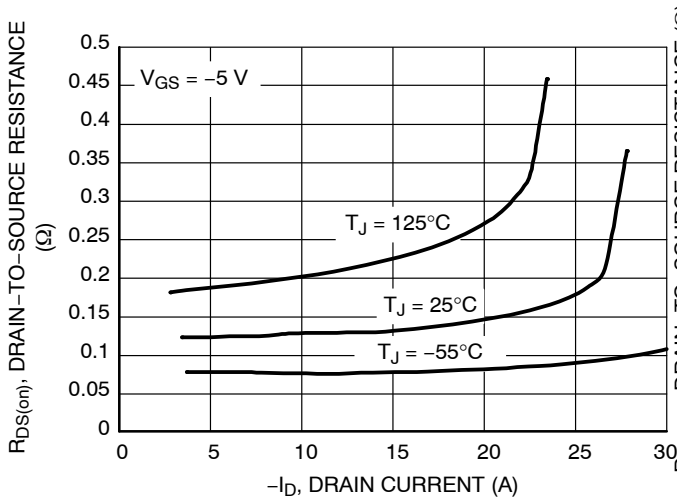

Figure 3. On-Resistance versus Drain Current and Temperature

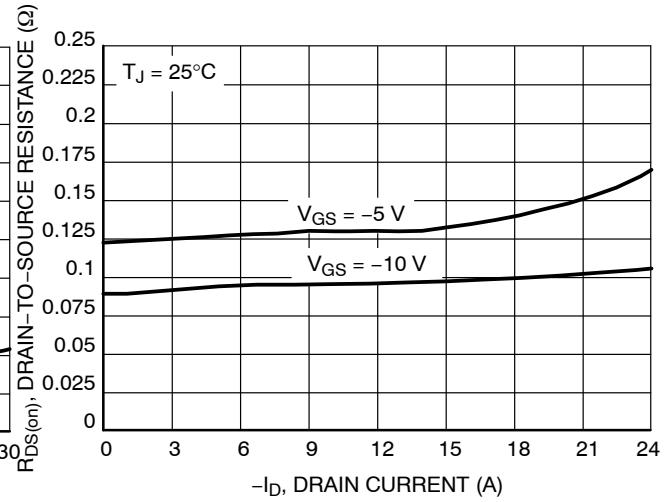

Figure 4. On-Resistance versus Drain Current and Gate Voltage

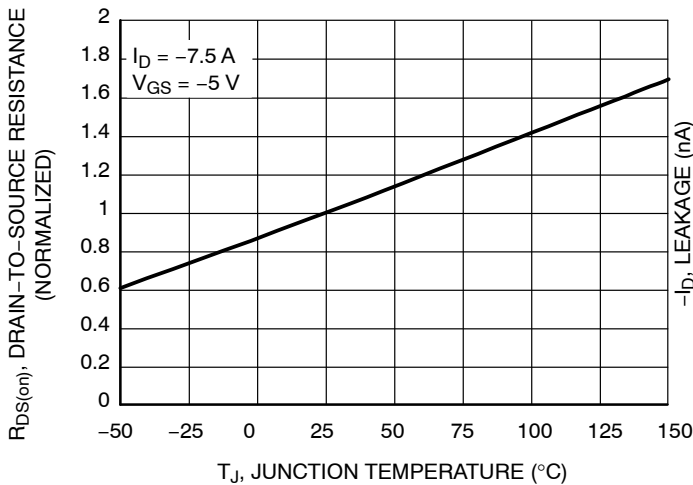

Figure 5. On-Resistance Variation with Temperature

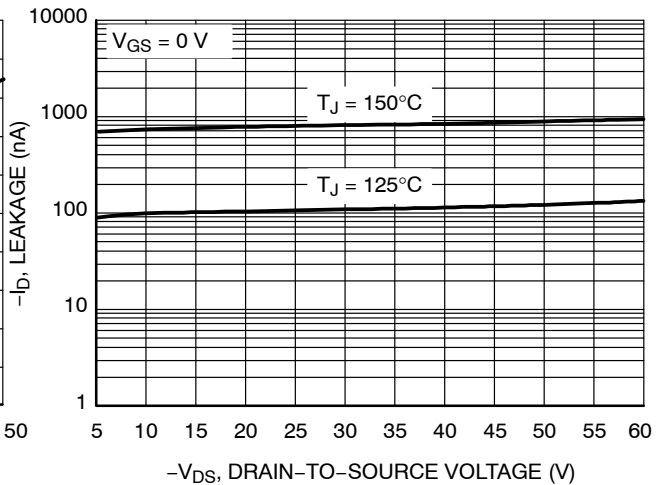
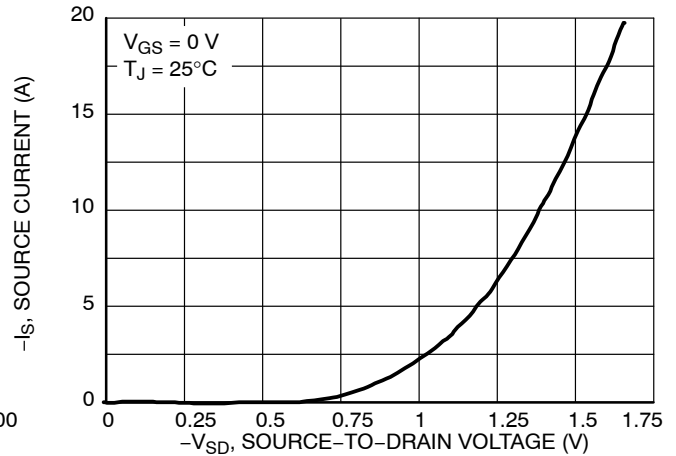
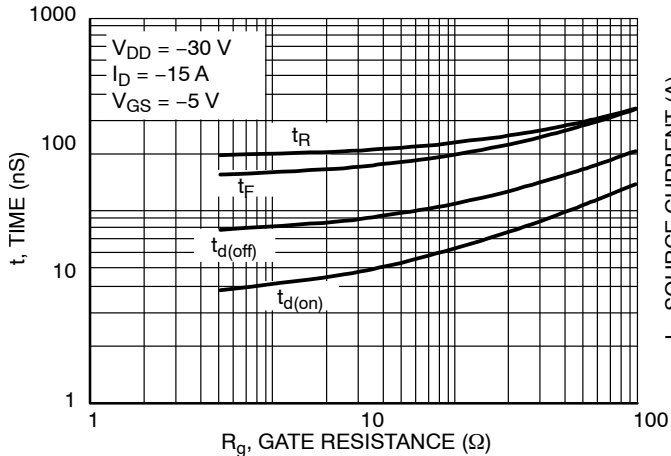
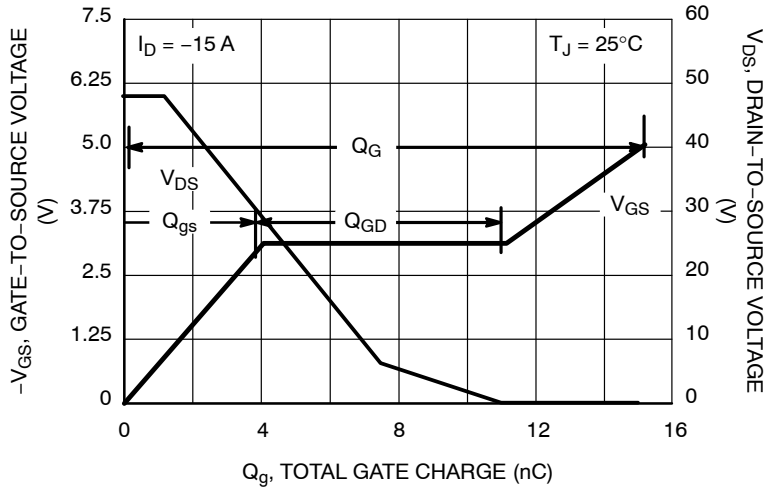
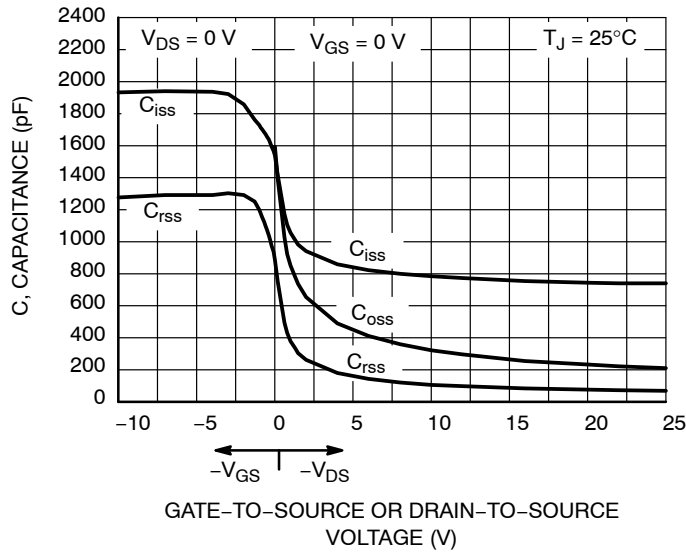

Figure 6. Drain-to-Source Leakage Current versus Voltage

NTD20P06L, NTDV20P06L



NTD20P06L, NTDV20P06L

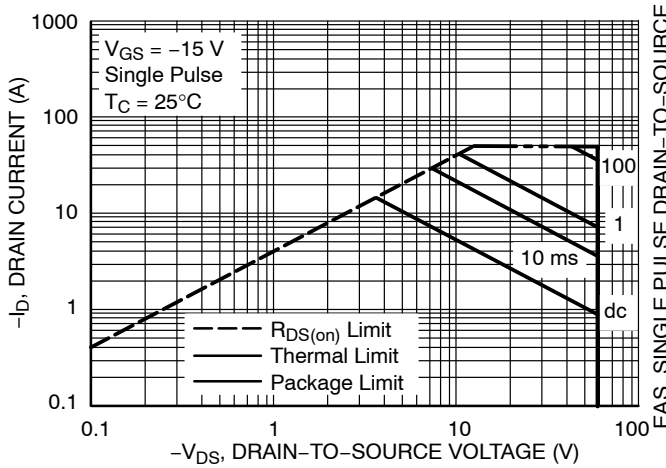

Figure 11. Maximum Rated Forward Biased Safe Operating Area

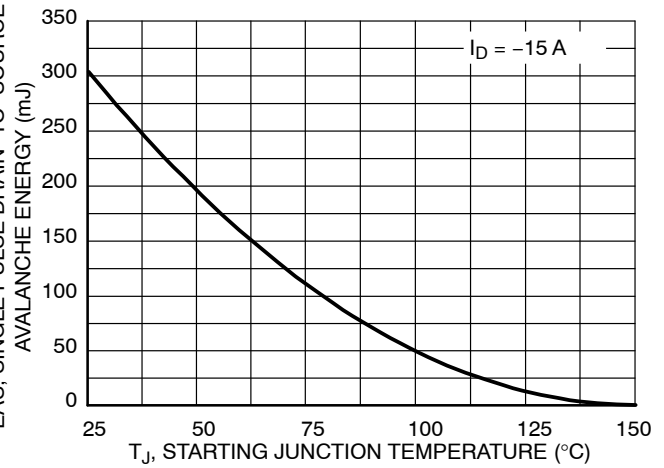

Figure 12. Maximum Avalanche Energy versus Starting Junction Temperature

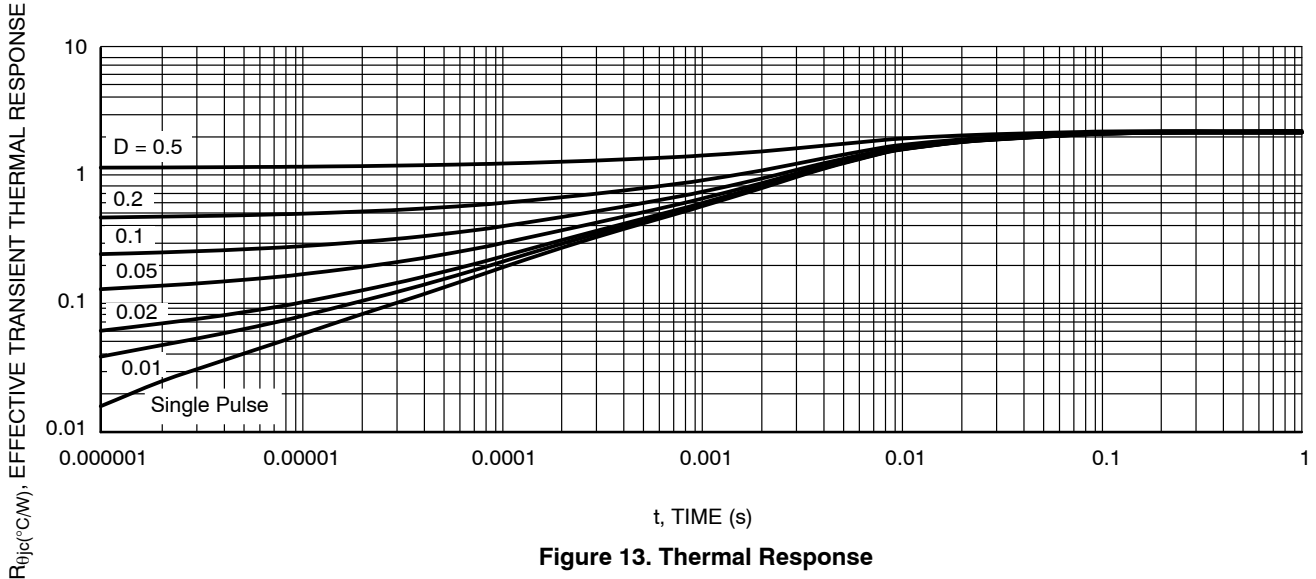

Figure 13. Thermal Response

ORDERING INFORMATION

Device	Package	Shipping [†]
NTD20P06LG	DPAK (Pb-Free)	75 Units / Rail
NTD20P06LT4G		2500 / Tape & Reel
NTDV20P06LT4G		2500 / Tape & Reel
NTDV20P06LT4G-VF01		2500 / Tape & Reel

[†]For information on tape and reel specifications, including part orientation and tape sizes, please refer to our Tape and Reel Packaging Specifications Brochure, BRD8011/D.

NTD20P06L, NTDV20P06L

PACKAGE DIMENSIONS

DPAK (SINGLE GAUGE) CASE 369C ISSUE F

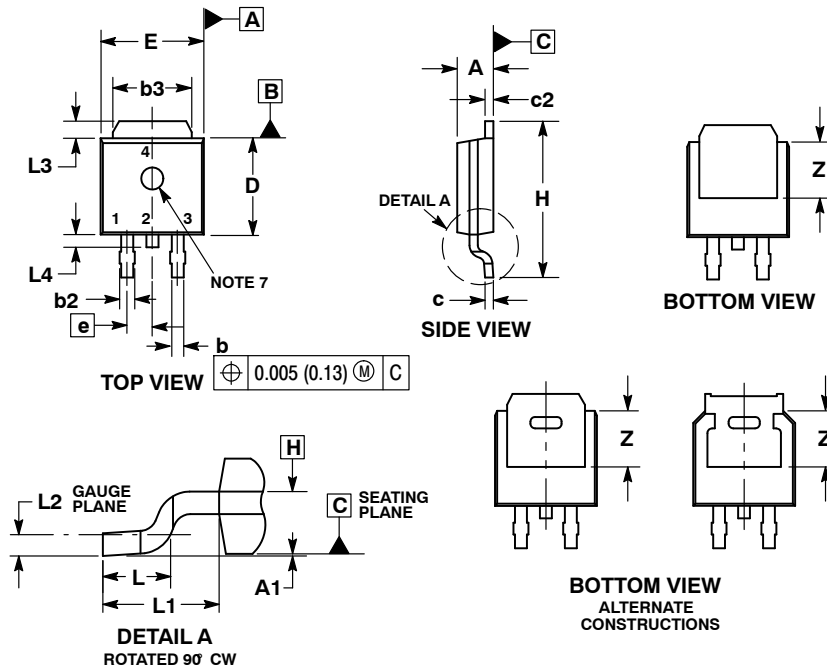

NOTES:

1. DIMENSIONING AND TOLERANCING PER ASME Y14.5M, 1994.
2. CONTROLLING DIMENSION: INCHES.
3. THERMAL PAD CONTOUR OPTIONAL WITHIN DIMENSIONS b3, L3 and Z.
4. DIMENSIONS D AND E DO NOT INCLUDE MOLD FLASH, PROTRUSIONS, OR BURRS. MOLD FLASH, PROTRUSIONS, OR GATE BURRS SHALL NOT EXCEED 0.006 INCHES PER SIDE.
5. DIMENSIONS D AND E ARE DETERMINED AT THE OUTERMOST EXTREMES OF THE PLASTIC BODY.
6. DATUMS A AND B ARE DETERMINED AT DATUM PLANE H.
7. OPTIONAL MOLD FEATURE.

DIM	INCHES		MILLIMETERS	
	MIN	MAX	MIN	MAX
A	0.086	0.094	2.18	2.38
A1	0.000	0.005	0.00	0.13
b	0.025	0.035	0.63	0.89
b2	0.028	0.045	0.72	1.14
b3	0.180	0.215	4.57	5.46
c	0.018	0.024	0.46	0.61
c2	0.018	0.024	0.46	0.61
D	0.235	0.245	5.97	6.22
E	0.250	0.265	6.35	6.73
e	0.090 BSC		2.29 BSC	
H	0.370	0.410	9.40	10.41
L	0.055	0.070	1.40	1.78
L1	0.114 REF		2.90 REF	
L2	0.020 BSC		0.51 BSC	
L3	0.035	0.050	0.89	1.27
L4	---	0.040	---	1.01
Z	0.155	---	3.93	---

STYLE 2:

- PIN 1. GATE
- DRAIN
- SOURCE
- DRAIN

SOLDERING FOOTPRINT*

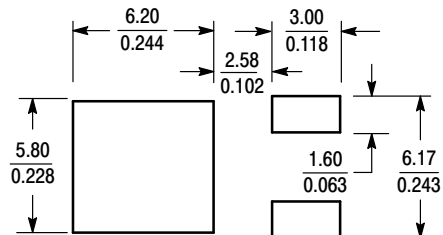

SCALE 3:1 $\left(\frac{\text{mm}}{\text{inches}}\right)$

*For additional information on our Pb-Free strategy and soldering details, please download the ON Semiconductor Soldering and Mounting Techniques Reference Manual, SOLDERRM/D.

NTD20P06L, NTDV20P06L

PACKAGE DIMENSIONS

IPAK CASE 369D ISSUE C

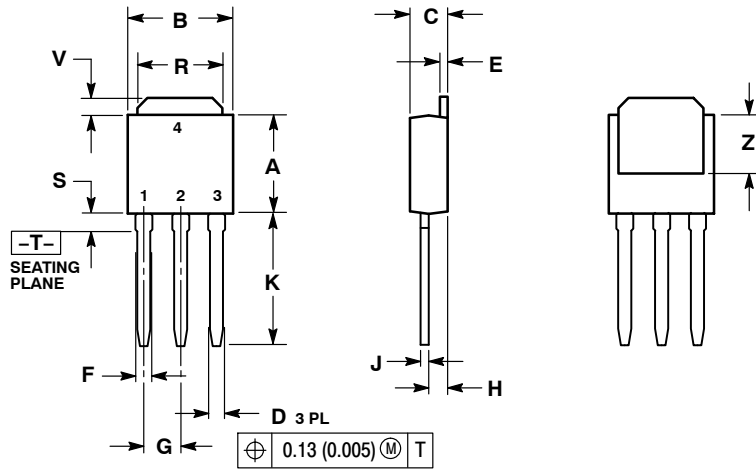

NOTES:

1. DIMENSIONING AND TOLERANCING PER ANSI Y14.5M, 1982.
2. CONTROLLING DIMENSION: INCH.

DIM	INCHES		MILLIMETERS	
	MIN	MAX	MIN	MAX
A	0.235	0.245	5.97	6.35
B	0.250	0.265	6.35	6.73
C	0.086	0.094	2.19	2.38
D	0.027	0.035	0.69	0.88
E	0.018	0.023	0.46	0.58
F	0.037	0.045	0.94	1.14
G	0.090 BSC		2.29 BSC	
H	0.034	0.040	0.87	1.01
J	0.018	0.023	0.46	0.58
K	0.350	0.380	8.89	9.65
R	0.180	0.215	4.45	5.45
S	0.025	0.040	0.63	1.01
V	0.035	0.050	0.89	1.27
Z	0.155	---	3.93	---

STYLE 2:

- PIN 1. GATE
- DRAIN
- SOURCE
- DRAIN

ON Semiconductor and are trademarks of Semiconductor Components Industries, LLC dba ON Semiconductor or its subsidiaries in the United States and/or other countries. ON Semiconductor owns the rights to a number of patents, trademarks, copyrights, trade secrets, and other intellectual property. A listing of ON Semiconductor's product/patent coverage may be accessed at www.onsemi.com/site/pdf/Patent-Marking.pdf. ON Semiconductor reserves the right to make changes without further notice to any products herein. ON Semiconductor makes no warranty, representation or guarantee regarding the suitability of its products for any particular purpose, nor does ON Semiconductor assume any liability arising out of the application or use of any product or circuit, and specifically disclaims any and all liability, including without limitation special, consequential or incidental damages. Buyer is responsible for its products and applications using ON Semiconductor products, including compliance with all laws, regulations and safety requirements or standards, regardless of any support or applications information provided by ON Semiconductor. "Typical" parameters which may be provided in ON Semiconductor data sheets and/or specifications can and do vary in different applications and actual performance may vary over time. All operating parameters, including "Typicals" must be validated for each customer application by customer's technical experts. ON Semiconductor does not convey any license under its patent rights nor the rights of others. ON Semiconductor products are not designed, intended, or authorized for use as a critical component in life support systems or any FDA Class 3 medical devices or medical devices with a same or similar classification in a foreign jurisdiction or any devices intended for implantation in the human body. Should Buyer purchase or use ON Semiconductor products for any such unintended or unauthorized application, Buyer shall indemnify and hold ON Semiconductor and its officers, employees, subsidiaries, affiliates, and distributors harmless against all claims, costs, damages, and expenses, and reasonable attorney fees arising out of, directly or indirectly, any claim of personal injury or death associated with such unintended or unauthorized use, even if such claim alleges that ON Semiconductor was negligent regarding the design or manufacture of the part. ON Semiconductor is an Equal Opportunity/Affirmative Action Employer. This literature is subject to all applicable copyright laws and is not for resale in any manner.

PUBLICATION ORDERING INFORMATION

LITERATURE FULFILLMENT:

Literature Distribution Center for ON Semiconductor
19521 E. 32nd Pkwy, Aurora, Colorado 80011 USA
Phone: 303-675-2175 or 800-344-3860 Toll Free USA/Canada
Fax: 303-675-2176 or 800-344-3867 Toll Free USA/Canada
Email: orderlit@onsemi.com

N. American Technical Support: 800-282-9855 Toll Free
USA/Canada
Europe, Middle East and Africa Technical Support:
Phone: 421 33 790 2910
Japan Customer Focus Center
Phone: 81-3-5817-1050

ON Semiconductor Website: www.onsemi.com

Order Literature: <http://www.onsemi.com/orderlit>

For additional information, please contact your local Sales Representative

Looking for pricing, stock, or lifecycle information?

Click below to explore more details on WIN SOURCE:

 [View NTD20P06L-1G on WIN SOURCE](#)

 [ON Semiconductor](#) Information

Optimize Your Supply Chain with WIN SOURCE Solutions

-  Global Sourcing Solution
-  Obsolete Management
-  Cost Control Management
-  Shortage Management
-  Alternative Solution
-  Excess Inventory Management