



**FEATURES**
**330 MSPS throughput rate**
**Triple 10-bit digital-to-analog converters (DACs)**
**SFDR**

 -70 dB at  $f_{CLK} = 50$  MHz;  $f_{OUT} = 1$  MHz

 -53 dB at  $f_{CLK} = 140$  MHz;  $f_{OUT} = 40$  MHz

**RS-343A-/RS-170-compatible output**
**Complementary outputs**
**DAC output current range: 2.0 mA to 26.5 mA**
**TTL-compatible inputs**
**Internal reference (1.235 V)**
**Single-supply 5 V/3.3 V operation**
**48-lead LQFP package**
**Low power dissipation (30 mW minimum @ 3 V)**
**Low power standby mode (6 mW typical @ 3 V)**
**Industrial temperature range (-40°C to +85°C)**
**Pb-free (lead-free) package**
**APPLICATIONS**
**Digital video systems (1600 × 1200 @ 100 Hz)**
**High resolution color graphics**
**Digital radio modulation**
**Image processing**
**Instrumentation**
**Video signal reconstruction**
**GENERAL DESCRIPTION**

The ADV7123 (ADV<sup>®</sup>) is a triple high speed, digital-to-analog converter on a single monolithic chip. It consists of three high speed, 10-bit, video DACs with complementary outputs, a standard TTL input interface, and a high impedance, analog output current source.

The ADV7123 has three separate 10-bit-wide input ports. A single 5 V/3.3 V power supply and clock are all that are required to make the part functional. The ADV7123 has additional video control signals, composite SYNC and BLANK.

The ADV7123 also has a power save mode.

**FUNCTIONAL BLOCK DIAGRAM**

Figure 1.

00215-001

The ADV7123 is fabricated in a 5 V CMOS process. Its monolithic CMOS construction ensures greater functionality with lower power dissipation. The ADV7123 is available in a 48-lead LQFP package.

**PRODUCT HIGHLIGHTS**

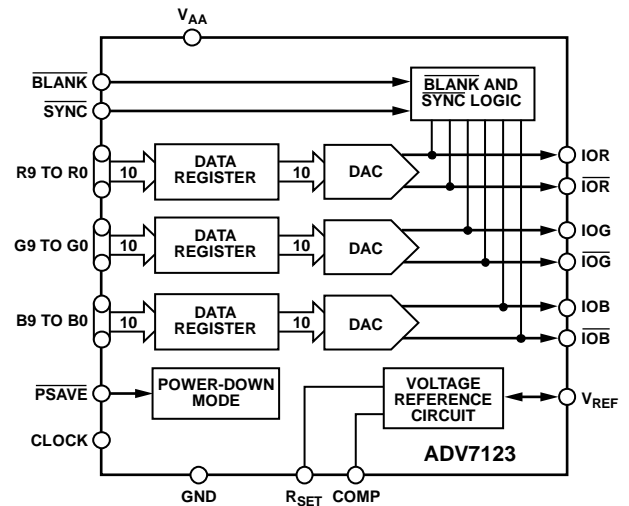
1. 330 MSPS throughput.
2. Guaranteed monotonic to 10 bits.
3. Compatible with a wide variety of high resolution color graphics systems, including RS-343A and RS-170.

ADV is a registered trademark of Analog Devices, Inc.

**Rev. D**

Information furnished by Analog Devices is believed to be accurate and reliable. However, no responsibility is assumed by Analog Devices for its use, nor for any infringements of patents or other rights of third parties that may result from its use. Specifications subject to change without notice. No license is granted by implication or otherwise under any patent or patent rights of Analog Devices. Trademarks and registered trademarks are the property of their respective owners.

One Technology Way, P.O. Box 9106, Norwood, MA 02062-9106, U.S.A.

Tel: 781.329.4700

Fax: 781.461.3113

[www.analog.com](http://www.analog.com)

©2010 Analog Devices, Inc. All rights reserved.

## TABLE OF CONTENTS

Features .....	1	3 V Typical Performance Characteristics.....	14
Applications.....	1	Terminology.....	16
Functional Block Diagram .....	1	Circuit Description and Operation.....	17
General Description .....	1	Digital Inputs .....	17
Product Highlights .....	1	Clock Input.....	17
Revision History .....	2	Video Synchronization and Control.....	18
Specifications.....	3	Reference Input.....	18
5 V Specifications .....	3	DACs.....	18
3.3 V Specifications .....	4	Analog Outputs .....	18
5 V Dynamic Specifications .....	5	Gray Scale Operation.....	19
3.3 V Dynamic Specifications.....	6	Video Output Buffers.....	19
5 V Timing Specifications .....	7	PCB Layout Considerations.....	19
3.3 V Timing Specifications .....	8	Digital Signal Interconnect .....	19
Absolute Maximum Ratings.....	9	Analog Signal Interconnect.....	20
ESD Caution.....	9	Outline Dimensions .....	21
Pin Configuration and Function Descriptions.....	10	Ordering Guide .....	21
Typical Performance Characteristics .....	12		
5 V Typical Performance Characteristics.....	12		

## REVISION HISTORY

### 7/10—Rev. C to Rev. D

Changes to Figure 2.....	9
Changes to Figure 22 and Figure 23.....	17
Changes to Table 9.....	18

### 3/09—Rev. B to Rev. C

Updated Format.....	Universal
Changes to Features Section.....	1
Changes to Table 5.....	7
Changes to Table 6.....	8
Changes to Table 8.....	10
Changed $f_{\text{CLOCK}}$ to $f_{\text{CLK}}$ .....	12
Changes to Figure 6, Figure 7, and Figure 8.....	12
Changes to Figure 13 and Figure 17.....	14
Deleted Ground Planes Section, Power Planes Section, and Supply Decoupling Section .....	15
Changes to Figure 23.....	17
Changes to Table 9, Analog Outputs Section, Figure 24, and Figure 25 .....	18
Changes to Video Output Buffers Section and PCB Layout Considerations Section .....	19
Changes to Analog Signal Interconnect Section and Figure 28 .....	20
Updated Outline Dimensions .....	21
Changes to Ordering Guide .....	21

### 10/02—Rev. A to Rev. B

Change in Title.....	1
Change to Feature.....	1
Change to Product Highlights .....	1
Change Specifications .....	3
Change to Pin Function Descriptions .....	10
Change to Reference Input section .....	18
Change to Figure 28 .....	22
Updated Outline Dimensions .....	23
Change to Ordering Guide.....	23

## SPECIFICATIONS

### 5 V SPECIFICATIONS

$V_{AA} = 5\text{ V} \pm 5\%$ ,  $V_{REF} = 1.235\text{ V}$ ,  $R_{SET} = 560\ \Omega$ ,  $C_L = 10\text{ pF}$ . All specifications  $T_{MIN}$  to  $T_{MAX}$ ,<sup>1</sup> unless otherwise noted,  $T_{JMAX} = 110^\circ\text{C}$ .

Table 1.

Parameter	Min	Typ	Max	Unit	Test Conditions <sup>1</sup>
STATIC PERFORMANCE					
Resolution (Each DAC)	10			Bits	
Integral Nonlinearity (BSL)	-1	±0.4	+1	LSB	
Differential Nonlinearity	-1	±0.25	+1	LSB	Guaranteed Monotonic
DIGITAL AND CONTROL INPUTS					
Input High Voltage, $V_{IH}$	2			V	
Input Low Voltage, $V_{IL}$			0.8	V	
Input Current, $I_{IN}$	-1		+1	μA	$V_{IN} = 0.0\text{ V or }V_{DD}$
PSAVE Pull-Up Current		20		μA	
Input Capacitance, $C_{IN}$		10		pF	
ANALOG OUTPUTS					
Output Current	2.0		26.5	mA	Green DAC, $\overline{SYNC} = \text{high}$
	2.0		18.5	mA	RGB DAC, $\overline{SYNC} = \text{low}$
DAC-to-DAC Matching		1.0	5	%	
Output Compliance Range, $V_{OC}$	0		1.4	V	
Output Impedance, $R_{OUT}$		100		kΩ	
Output Capacitance, $C_{OUT}$		10		pF	$I_{OUT} = 0\text{ mA}$
Offset Error	-0.025		+0.025	% FSR	Tested with DAC output = 0 V
Gain Error <sup>2</sup>	-5.0		+5.0	% FSR	FSR = 17.62 mA
VOLTAGE REFERENCE, EXTERNAL AND INTERNAL					
Reference Range, $V_{REF}$	1.12	1.235	1.35	V	
POWER DISSIPATION					
Digital Supply Current <sup>3</sup>		3.4	9	mA	$f_{CLK} = 50\text{ MHz}$
		10.5	15	mA	$f_{CLK} = 140\text{ MHz}$
		18	25	mA	$f_{CLK} = 240\text{ MHz}$
Analog Supply Current		67	72	mA	$R_{SET} = 560\ \Omega$
		8		mA	$R_{SET} = 4933\ \Omega$
Standby Supply Current <sup>4</sup>		2.1	5.0	mA	PSAVE = low, digital, and control inputs at $V_{DD}$
Power Supply Rejection Ratio		0.1	0.5	%/%	

<sup>1</sup> Temperature range  $T_{MIN}$  to  $T_{MAX}$ :  $-40^\circ\text{C}$  to  $+85^\circ\text{C}$  at 50 MHz and 140 MHz,  $0^\circ\text{C}$  to  $70^\circ\text{C}$  at 240 MHz and 330 MHz.

<sup>2</sup> Gain error =  $\{(Measured\ (FSC)/Ideal\ (FSC) - 1) \times 100\}$ , where  $Ideal = V_{REF}/R_{SET} \times K \times (0x3FFH)$  and  $K = 7.9896$ .

<sup>3</sup> Digital supply is measured with a continuous clock that has data input corresponding to a ramp pattern and with an input level at 0 V and  $V_{DD}$ .

<sup>4</sup> These maximum/minimum specifications are guaranteed by characterization to be over the 4.75 V to 5.25 V range.

# ADV7123

## 3.3 V SPECIFICATIONS

$V_{AA} = 3.0\text{ V to }3.6\text{ V}$ ,  $V_{REF} = 1.235\text{ V}$ ,  $R_{SET} = 560\ \Omega$ ,  $C_L = 10\text{ pF}$ . All specifications  $T_{MIN}$  to  $T_{MAX}$ ,<sup>1</sup> unless otherwise noted,  $T_{JMAX} = 110^\circ\text{C}$ .

Table 2.

Parameter <sup>2</sup>	Min	Typ	Max	Unit	Test Conditions <sup>1</sup>
STATIC PERFORMANCE					
Resolution (Each DAC)			10	Bits	$R_{SET} = 680\ \Omega$
Integral Nonlinearity (BSL)	-1	+0.5	+1	LSB	$R_{SET} = 680\ \Omega$
Differential Nonlinearity	-1	+0.25	+1	LSB	$R_{SET} = 680\ \Omega$
DIGITAL AND CONTROL INPUTS					
Input High Voltage, $V_{IH}$	2.0			V	$V_{IN} = 0.0\text{ V or }V_{DD}$
Input Low Voltage, $V_{IL}$		0.8		V	
Input Current, $I_{IN}$	-1		+1	$\mu\text{A}$	
PSAVE Pull-Up Current		20		$\mu\text{A}$	
Input Capacitance, $C_{IN}$		10		pF	
ANALOG OUTPUTS					
Output Current	2.0		26.5	mA	Green DAC, $\overline{SYNC} = \text{high}$
	2.0		18.5	mA	RGB DAC, $\overline{SYNC} = \text{low}$
DAC-to-DAC Matching		1.0		%	
Output Compliance Range, $V_{OC}$	0		1.4	V	
Output Impedance, $R_{OUT}$		70		k $\Omega$	
Output Capacitance, $C_{OUT}$		10		pF	
Offset Error		0	0	% FSR	Tested with DAC output = 0 V
Gain Error <sup>3</sup>		0		% FSR	FSR = 17.62 mA
VOLTAGE REFERENCE, EXTERNAL					
Reference Range, $V_{REF}$	1.12	1.235	1.35	V	
VOLTAGE REFERENCE, INTERNAL					
Voltage Reference, $V_{REF}$		1.235		V	
POWER DISSIPATION					
Digital Supply Current <sup>4</sup>		2.2	5.0	mA	$f_{CLK} = 50\text{ MHz}$
		6.5	12.0	mA	$f_{CLK} = 140\text{ MHz}$
		11	15	mA	$f_{CLK} = 240\text{ MHz}$
		16		mA	$f_{CLK} = 330\text{ MHz}$
Analog Supply Current		67	72	mA	$R_{SET} = 560\ \Omega$
		8		mA	$R_{SET} = 4933\ \Omega$
Standby Supply Current		2.1	5.0	mA	PSAVE = low, digital, and control inputs at $V_{DD}$
Power Supply Rejection Ratio		0.1	0.5	%/%	

<sup>1</sup> Temperature range  $T_{MIN}$  to  $T_{MAX}$ :  $-40^\circ\text{C}$  to  $+85^\circ\text{C}$  at 50 MHz and 140 MHz,  $0^\circ\text{C}$  to  $70^\circ\text{C}$  at 240 MHz and 330 MHz.

<sup>2</sup> These maximum/minimum specifications are guaranteed by characterization to be over the 3.0 V to 3.6 V range.

<sup>3</sup> Gain error =  $\{(\text{Measured (FSC)}/\text{Ideal (FSC)} - 1) \times 100\}$ , where  $\text{Ideal} = V_{REF}/R_{SET} \times K \times (0x3FFH)$  and  $K = 7.9896$ .

<sup>4</sup> Digital supply is measured with a continuous clock that has data input corresponding to a ramp pattern and with an input level at 0 V and  $V_{DD}$ .

## 5 V DYNAMIC SPECIFICATIONS

$V_{AA} = 5\text{ V} \pm 5\%$ ,  $V_{REF} = 1.235\text{ V}$ ,  $R_{SET} = 560\ \Omega$ ,  $C_L = 10\text{ pF}$ . All specifications are  $T_A = 25^\circ\text{C}$ , unless otherwise noted,  $T_{JMAX} = 110^\circ\text{C}$ .

Table 3.

Parameter <sup>1</sup>	Min	Typ	Max	Unit
<b>AC LINEARITY</b>				
<b>Spurious-Free Dynamic Range to Nyquist<sup>2</sup></b>				
<b>Single-Ended Output</b>				
$f_{CLK} = 50\text{ MHz}; f_{OUT} = 1.00\text{ MHz}$		67		dBc
$f_{CLK} = 50\text{ MHz}; f_{OUT} = 2.51\text{ MHz}$		67		dBc
$f_{CLK} = 50\text{ MHz}; f_{OUT} = 5.04\text{ MHz}$		63		dBc
$f_{CLK} = 50\text{ MHz}; f_{OUT} = 20.2\text{ MHz}$		55		dBc
$f_{CLK} = 100\text{ MHz}; f_{OUT} = 2.51\text{ MHz}$		62		dBc
$f_{CLK} = 100\text{ MHz}; f_{OUT} = 5.04\text{ MHz}$		60		dBc
$f_{CLK} = 100\text{ MHz}; f_{OUT} = 20.2\text{ MHz}$		54		dBc
$f_{CLK} = 100\text{ MHz}; f_{OUT} = 40.4\text{ MHz}$		48		dBc
$f_{CLK} = 140\text{ MHz}; f_{OUT} = 2.51\text{ MHz}$		57		dBc
$f_{CLK} = 140\text{ MHz}; f_{OUT} = 5.04\text{ MHz}$		58		dBc
$f_{CLK} = 140\text{ MHz}; f_{OUT} = 20.2\text{ MHz}$		52		dBc
$f_{CLK} = 140\text{ MHz}; f_{OUT} = 40.4\text{ MHz}$		41		dBc
<b>Double-Ended Output</b>				
$f_{CLK} = 50\text{ MHz}; f_{OUT} = 1.00\text{ MHz}$		70		dBc
$f_{CLK} = 50\text{ MHz}; f_{OUT} = 2.51\text{ MHz}$		70		dBc
$f_{CLK} = 50\text{ MHz}; f_{OUT} = 5.04\text{ MHz}$		65		dBc
$f_{CLK} = 50\text{ MHz}; f_{OUT} = 20.2\text{ MHz}$		54		dBc
$f_{CLK} = 100\text{ MHz}; f_{OUT} = 2.51\text{ MHz}$		67		dBc
$f_{CLK} = 100\text{ MHz}; f_{OUT} = 5.04\text{ MHz}$		63		dBc
$f_{CLK} = 100\text{ MHz}; f_{OUT} = 20.2\text{ MHz}$		58		dBc
$f_{CLK} = 100\text{ MHz}; f_{OUT} = 40.4\text{ MHz}$		52		dBc
$f_{CLK} = 140\text{ MHz}; f_{OUT} = 2.51\text{ MHz}$		62		dBc
$f_{CLK} = 140\text{ MHz}; f_{OUT} = 5.04\text{ MHz}$		61		dBc
$f_{CLK} = 140\text{ MHz}; f_{OUT} = 20.2\text{ MHz}$		55		dBc
$f_{CLK} = 140\text{ MHz}; f_{OUT} = 40.4\text{ MHz}$		53		dBc
<b>Spurious-Free Dynamic Range Within a Window</b>				
<b>Single-Ended Output</b>				
$f_{CLK} = 50\text{ MHz}; f_{OUT} = 1.00\text{ MHz}; 1\text{ MHz Span}$		77		dBc
$f_{CLK} = 50\text{ MHz}; f_{OUT} = 5.04\text{ MHz}; 2\text{ MHz Span}$		73		dBc
$f_{CLK} = 140\text{ MHz}; f_{OUT} = 5.04\text{ MHz}; 4\text{ MHz Span}$		64		dBc
<b>Double-Ended Output</b>				
$f_{CLK} = 50\text{ MHz}; f_{OUT} = 1.00\text{ MHz}; 1\text{ MHz Span}$		74		dBc
$f_{CLK} = 50\text{ MHz}; f_{OUT} = 5.00\text{ MHz}; 2\text{ MHz Span}$		73		dBc
$f_{CLK} = 140\text{ MHz}; f_{OUT} = 5.00\text{ MHz}; 4\text{ MHz Span}$		60		dBc
<b>Total Harmonic Distortion</b>				
$f_{CLK} = 50\text{ MHz}; f_{OUT} = 1.00\text{ MHz}$				
$T_A = 25^\circ\text{C}$		66		dBc
$T_{MIN}$ to $T_{MAX}$		65		dBc
$f_{CLK} = 50\text{ MHz}; f_{OUT} = 2.00\text{ MHz}$		64		dBc
$f_{CLK} = 100\text{ MHz}; f_{OUT} = 2.00\text{ MHz}$		63		dBc
$f_{CLK} = 140\text{ MHz}; f_{OUT} = 2.00\text{ MHz}$		55		dBc

# ADV7123

Parameter <sup>1</sup>	Min	Typ	Max	Unit
<b>DAC PERFORMANCE</b>				
Glitch Impulse		10		pV-sec
DAC-to-DAC Crosstalk <sup>3</sup>		23		dB
Data Feedthrough <sup>4, 5</sup>		22		dB
Clock Feedthrough <sup>4, 5</sup>		33		dB

<sup>1</sup> These maximum/minimum specifications are guaranteed by characterization over the 4.75 V to 5.25 V range.

<sup>2</sup> Note that the ADV7123 exhibits high performance when operating with an internal voltage reference,  $V_{REF}$ .

<sup>3</sup> DAC-to-DAC crosstalk is measured by holding one DAC high while the other two are making low-to-high and high-to-low transitions.

<sup>4</sup> Clock and data feedthrough is a function of the amount of overshoot and undershoot on the digital inputs. Glitch impulse includes clock and data feedthrough.

<sup>5</sup> TTL input values are 0 V to 3 V, with input rise/fall times of  $-3$  ns, measured from the 10% and 90% points. Timing reference points are 50% for inputs and outputs.

## 3.3 V DYNAMIC SPECIFICATIONS

$V_{AA} = 3.0$  V to  $3.6$  V<sup>1</sup>,  $V_{REF} = 1.235$  V,  $R_{SET} = 680$   $\Omega$ ,  $C_L = 10$  pF. All specifications are  $T_A = 25^\circ\text{C}$ , unless otherwise noted,  $T_{JMAX} = 110^\circ\text{C}$ .

Table 4.

Parameter	Min	Typ	Max	Unit
<b>AC LINEARITY</b>				
<b>Spurious-Free Dynamic Range to Nyquist<sup>2</sup></b>				
<b>Single-Ended Output</b>				
$f_{CLK} = 50$ MHz; $f_{OUT} = 1.00$ MHz		67		dBc
$f_{CLK} = 50$ MHz; $f_{OUT} = 2.51$ MHz		67		dBc
$f_{CLK} = 50$ MHz; $f_{OUT} = 5.04$ MHz		63		dBc
$f_{CLK} = 50$ MHz; $f_{OUT} = 20.2$ MHz		55		dBc
$f_{CLK} = 100$ MHz; $f_{OUT} = 2.51$ MHz		62		dBc
$f_{CLK} = 100$ MHz; $f_{OUT} = 5.04$ MHz		60		dBc
$f_{CLK} = 100$ MHz; $f_{OUT} = 20.2$ MHz		54		dBc
$f_{CLK} = 100$ MHz; $f_{OUT} = 40.4$ MHz		48		dBc
$f_{CLK} = 140$ MHz; $f_{OUT} = 2.51$ MHz		57		dBc
$f_{CLK} = 140$ MHz; $f_{OUT} = 5.04$ MHz		58		dBc
$f_{CLK} = 140$ MHz; $f_{OUT} = 20.2$ MHz		52		dBc
$f_{CLK} = 140$ MHz; $f_{OUT} = 40.4$ MHz		41		dBc
<b>Double-Ended Output</b>				
$f_{CLK} = 50$ MHz; $f_{OUT} = 1.00$ MHz		70		dBc
$f_{CLK} = 50$ MHz; $f_{OUT} = 2.51$ MHz		70		dBc
$f_{CLK} = 50$ MHz; $f_{OUT} = 5.04$ MHz		65		dBc
$f_{CLK} = 50$ MHz; $f_{OUT} = 20.2$ MHz		54		dBc
$f_{CLK} = 100$ MHz; $f_{OUT} = 2.51$ MHz		67		dBc
$f_{CLK} = 100$ MHz; $f_{OUT} = 5.04$ MHz		63		dBc
$f_{CLK} = 100$ MHz; $f_{OUT} = 20.2$ MHz		58		dBc
$f_{CLK} = 100$ MHz; $f_{OUT} = 40.4$ MHz		52		dBc
$f_{CLK} = 140$ MHz; $f_{OUT} = 2.51$ MHz		62		dBc
$f_{CLK} = 140$ MHz; $f_{OUT} = 5.04$ MHz		61		dBc
$f_{CLK} = 140$ MHz; $f_{OUT} = 20.2$ MHz		55		dBc
$f_{CLK} = 140$ MHz; $f_{OUT} = 40.4$ MHz		53		dBc
<b>Spurious-Free Dynamic Range Within a Window</b>				
<b>Single-Ended Output</b>				
$f_{CLK} = 50$ MHz; $f_{OUT} = 1.00$ MHz; 1 MHz Span		77		dBc
$f_{CLK} = 50$ MHz; $f_{OUT} = 5.04$ MHz; 2 MHz Span		73		dBc
$f_{CLK} = 140$ MHz; $f_{OUT} = 5.04$ MHz; 4 MHz Span		64		dBc
<b>Double-Ended Output</b>				
$f_{CLK} = 50$ MHz; $f_{OUT} = 1.00$ MHz; 1 MHz Span		74		dBc
$f_{CLK} = 50$ MHz; $f_{OUT} = 5.00$ MHz; 2 MHz Span		73		dBc
$f_{CLK} = 140$ MHz; $f_{OUT} = 5.00$ MHz; 4 MHz Span		60		dBc

Parameter	Min	Typ	Max	Unit
Total Harmonic Distortion				
$f_{CLK} = 50 \text{ MHz}; f_{OUT} = 1.00 \text{ MHz}$				
$T_A = 25^\circ\text{C}$		66		dBc
$T_{MIN}$ to $T_{MAX}$		65		dBc
$f_{CLK} = 50 \text{ MHz}; f_{OUT} = 2.00 \text{ MHz}$		64		dBc
$f_{CLK} = 100 \text{ MHz}; f_{OUT} = 2.00 \text{ MHz}$		64		dBc
$f_{CLK} = 140 \text{ MHz}; f_{OUT} = 2.00 \text{ MHz}$		55		dBc
<b>DAC PERFORMANCE</b>				
Glitch Impulse		10		pV-sec
DAC-to-DAC Crosstalk <sup>3</sup>		23		dB
Data Feedthrough <sup>4, 5</sup>		22		dB
Clock Feedthrough <sup>4, 5</sup>		33		dB

<sup>1</sup> These maximum/minimum specifications are guaranteed by characterization over the 3.0 V to 3.6 V range.

<sup>2</sup> Note that the ADV7123 exhibits high performance when operating with an internal voltage reference,  $V_{REF}$ .

<sup>3</sup> DAC-to-DAC crosstalk is measured by holding one DAC high while the other two are making low-to-high and high-to-low transitions.

<sup>4</sup> Clock and data feedthrough is a function of the amount of overshoot and undershoot on the digital inputs. Glitch impulse includes clock and data feedthrough.

<sup>5</sup> TTL input values are 0 V to 3 V, with input rise/fall times of  $\sim 3$  ns, measured at the 10% and 90% points. Timing reference points are 50% for inputs and outputs.

## 5 V TIMING SPECIFICATIONS

$V_{AA} = 5 \text{ V} \pm 5\%$ , <sup>1</sup>  $V_{REF} = 1.235 \text{ V}$ ,  $R_{SET} = 560 \Omega$ ,  $C_L = 10 \text{ pF}$ . All specifications  $T_{MIN}$  to  $T_{MAX}$ ,<sup>2</sup> unless otherwise noted,  $T_{JMAX} = 110^\circ\text{C}$ .

**Table 5.**

Parameter <sup>3</sup>	Symbol	Min	Typ	Max	Unit	Conditions
<b>ANALOG OUTPUTS</b>						
Analog Output Delay	$t_6$		5.5		ns	
Analog Output Rise/Fall Time <sup>4</sup>	$t_7$		1.0		ns	
Analog Output Transition Time <sup>5</sup>	$t_8$		15		ns	
Analog Output Skew <sup>6</sup>	$t_9$		1	2	ns	
<b>CLOCK CONTROL</b>						
CLOCK Frequency <sup>7</sup>	$f_{CLK}$	0.5		50	MHz	50 MHz grade
		0.5		140	MHz	140 MHz grade
		0.5		240	MHz	240 MHz grade
Data and Control Setup	$t_1$	0.5			ns	
Data and Control Hold	$t_2$	1.5			ns	
CLOCK Period	$t_3$	4.17			ns	
CLOCK Pulse Width High	$t_4$	1.875			ns	$f_{CLK\_MAX} = 240 \text{ MHz}$
CLOCK Pulse Width Low	$t_5$	1.875			ns	$f_{CLK\_MAX} = 240 \text{ MHz}$
CLOCK Pulse Width High	$t_4$	2.85			ns	$f_{CLK\_MAX} = 140 \text{ MHz}$
CLOCK Pulse Width Low	$t_5$	2.85			ns	$f_{CLK\_MAX} = 140 \text{ MHz}$
CLOCK Pulse Width High	$t_4$	8.0			ns	$f_{CLK\_MAX} = 50 \text{ MHz}$
CLOCK Pulse Width Low	$t_5$	8.0			ns	$f_{CLK\_MAX} = 50 \text{ MHz}$
Pipeline Delay <sup>6</sup>	$t_{PD}$	1.0	1.0	1.0	Clock cycles	
PSAVE Up Time <sup>6</sup>	$t_{10}$		2	10	ns	

<sup>1</sup> These maximum and minimum specifications are guaranteed over this range.

<sup>2</sup> Temperature range:  $T_{MIN}$  to  $T_{MAX}$ :  $-40^\circ\text{C}$  to  $+85^\circ\text{C}$  at 50 MHz and 140 MHz,  $0^\circ\text{C}$  to  $70^\circ\text{C}$  at 240 MHz.

<sup>3</sup> Timing specifications are measured with input levels of 3.0 V ( $V_{IH}$ ) and 0 V ( $V_{IL}$ ) 0 for both 5 V and 3.3 V supplies.

<sup>4</sup> Rise time was measured from the 10% to 90% point of zero to full-scale transition, fall time from the 90% to 10% point of a full-scale transition.

<sup>5</sup> Measured from 50% point of full-scale transition to 2% of final value.

<sup>6</sup> Guaranteed by characterization.

<sup>7</sup>  $f_{CLK}$  maximum specification production tested at 125 MHz; 5 V limits specified here are guaranteed by characterization.

## 3.3 V TIMING SPECIFICATIONS

$V_{AA} = 3.0\text{ V to }3.6\text{ V}$ ,<sup>1</sup>  $V_{REF} = 1.235\text{ V}$ ,  $R_{SET} = 560\ \Omega$ ,  $C_L = 10\text{ pF}$ . All specifications  $T_{MIN}$  to  $T_{MAX}$ ,<sup>2</sup> unless otherwise noted,  $T_{JMAX} = 110^\circ\text{C}$ .

Table 6.

Parameter <sup>3</sup>	Symbol	Min	Typ	Max	Unit	Conditions
<b>ANALOG OUTPUTS</b>						
Analog Output Delay	$t_6$		7.5		ns	
Analog Output Rise/Fall Time <sup>4</sup>	$t_7$		1.0		ns	
Analog Output Transition Time <sup>5</sup>	$t_8$		15		ns	
Analog Output Skew <sup>6</sup>	$t_9$		12		ns	
<b>CLOCK CONTROL</b>						
CLOCK Frequency <sup>7</sup>	$f_{CLK}$			50	MHz	50 MHz grade
				140	MHz	140 MHz grade
				240	MHz	240 MHz grade
				330	MHz	330 MHz grade
Data and Control Setup	$t_1$	0.2			ns	
Data and Control Hold	$t_2$	1.5			ns	
CLOCK Period	$t_3$	3			ns	
CLOCK Pulse Width High <sup>6</sup>	$t_4$	1.4			ns	$f_{CLK\_MAX} = 330\text{ MHz}$
CLOCK Pulse Width Low <sup>6</sup>	$t_5$	1.4			ns	$f_{CLK\_MAX} = 330\text{ MHz}$
CLOCK Pulse Width High	$t_4$	1.875			ns	$f_{CLK\_MAX} = 240\text{ MHz}$
CLOCK Pulse Width Low	$t_5$	1.875			ns	$f_{CLK\_MAX} = 240\text{ MHz}$
CLOCK Pulse Width High	$t_4$	2.85			ns	$f_{CLK\_MAX} = 140\text{ MHz}$
CLOCK Pulse Width Low	$t_5$	2.85			ns	$f_{CLK\_MAX} = 140\text{ MHz}$
CLOCK Pulse Width High	$t_4$	8.0			ns	$f_{CLK\_MAX} = 50\text{ MHz}$
CLOCK Pulse Width Low	$t_5$	8.0			ns	$f_{CLK\_MAX} = 50\text{ MHz}$
Pipeline Delay <sup>6</sup>	$t_{PD}$	1.0	1.0	1.0	Clock cycles	
PSAVE Up Time <sup>6</sup>	$t_{10}$		4	10	ns	

<sup>1</sup> These maximum and minimum specifications are guaranteed over this range.

<sup>2</sup> Temperature range:  $T_{MIN}$  to  $T_{MAX}$ :  $-40^\circ\text{C}$  to  $+85^\circ\text{C}$  at 50 MHz and 140 MHz,  $0^\circ\text{C}$  to  $70^\circ\text{C}$  at 240 MHz and 330 MHz.

<sup>3</sup> Timing specifications are measured with input levels of 3.0 V ( $V_{IH}$ ) and 0 V ( $V_{IL}$ ) 0 for both 5 V and 3.3 V supplies.

<sup>4</sup> Rise time was measured from the 10% to 90% point of zero to full-scale transition, fall time from the 90% to 10% point of a full-scale transition.

<sup>5</sup> Measured from 50% point of full-scale transition to 2% of final value.

<sup>6</sup> Guaranteed by characterization.

<sup>7</sup>  $f_{CLK}$  maximum specification production tested at 125 MHz; 5 V limits specified here are guaranteed by characterization.

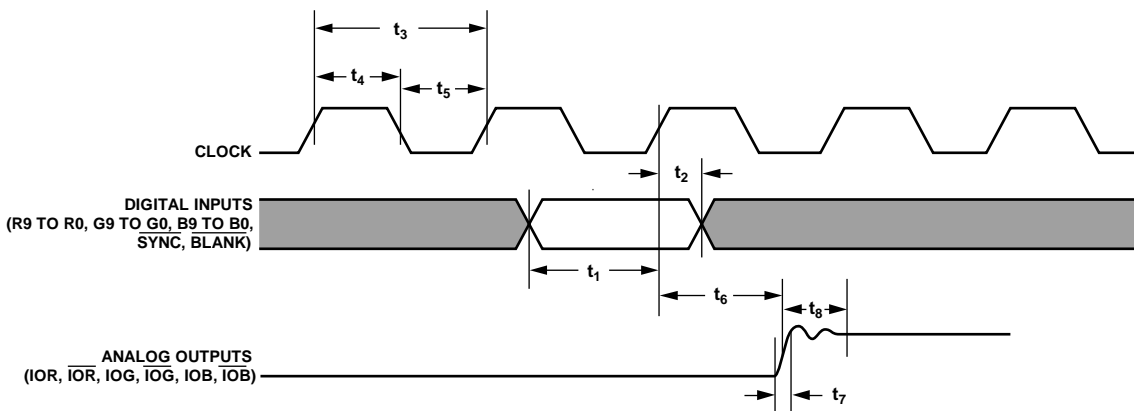

### NOTES

1. OUTPUT DELAY ( $t_6$ ) MEASURED FROM THE 50% POINT OF THE RISING EDGE OF CLOCK TO THE 50% POINT OF FULL-SCALE TRANSITION.
2. OUTPUT RISE/FALL TIME ( $t_7$ ) MEASURED BETWEEN THE 10% AND 90% POINTS OF FULL-SCALE TRANSITION.
3. TRANSITION TIME ( $t_8$ ) MEASURED FROM THE 50% POINT OF FULL-SCALE TRANSITION TO WITHIN 2% OF THE FINAL OUTPUT VALUE.

Figure 2. Timing Diagram

00215-002

## ABSOLUTE MAXIMUM RATINGS

Table 7.

Parameter	Rating
V <sub>AA</sub> to GND	7 V
Voltage on Any Digital Pin	GND – 0.5 V to V <sub>AA</sub> + 0.5 V
Ambient Operating Temperature (T <sub>A</sub> )	–40°C to +85°C
Storage Temperature (T <sub>S</sub> )	–65°C to +150°C
Junction Temperature (T <sub>J</sub> )	150°C
Lead Temperature (Soldering, 10 sec)	300°C
Vapor Phase Soldering (1 Minute)	220°C
I <sub>OUT</sub> to GND <sup>1</sup>	0 V to V <sub>AA</sub>

<sup>1</sup>Analog output short circuit to any power supply or common GND can be of an indefinite duration.

Stresses above those listed under Absolute Maximum Ratings may cause permanent damage to the device. This is a stress rating only; functional operation of the device at these or any other conditions above those indicated in the operational section of this specification is not implied. Exposure to absolute maximum rating conditions for extended periods may affect device reliability.

### ESD CAUTION



#### ESD (electrostatic discharge) sensitive device.

Charged devices and circuit boards can discharge without detection. Although this product features patented or proprietary protection circuitry, damage may occur on devices subjected to high energy ESD. Therefore, proper ESD precautions should be taken to avoid performance degradation or loss of functionality.

## PIN CONFIGURATION AND FUNCTION DESCRIPTIONS

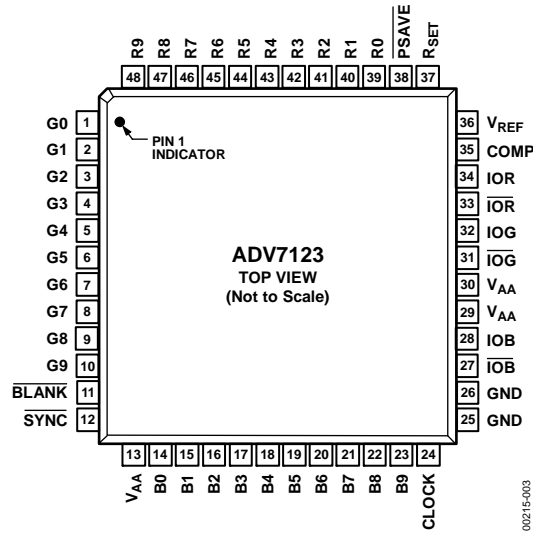

Figure 3. Pin Configuration

Table 8. Pin Function Descriptions

Pin No.	Mnemonic	Description
1 to 10, 14 to 23, 39 to 48	G0 to G9, B0 to B9, R0 to R9	Red, Green, and Blue Pixel Data Inputs (TTL Compatible). Pixel data is latched on the rising edge of CLOCK. R0, G0, and B0 are the least significant data bits. Unused pixel data inputs should be connected to either the regular printed circuit board (PCB) power or ground plane.
11	BLANK	Composite Blank Control Input (TTL Compatible). A Logic 0 on this control input drives the analog outputs, IOR, IOB, and IOG, to the blanking level. The BLANK signal is latched on the rising edge of CLOCK. While BLANK is a Logic 0, the R0 to R9, G0 to G9, and B0 to B9 pixel inputs are ignored.
12	SYNC	Composite Sync Control Input (TTL Compatible). A Logic 0 on the SYNC input switches off a 40 IRE current source. This is internally connected to the IOG analog output. SYNC does not override any other control or data input; therefore, it should only be asserted during the blanking interval. SYNC is latched on the rising edge of CLOCK. If sync information is not required on the green channel, the SYNC input should be tied to Logic 0.
13, 29, 30 24	V <sub>AA</sub> CLOCK	Analog Power Supply (5 V ± 5%). All V <sub>AA</sub> pins on the ADV7123 must be connected. Clock Input (TTL Compatible). The rising edge of CLOCK latches the R0 to R9, G0 to G9, B0 to B9, SYNC, and BLANK pixel and control inputs. It is typically the pixel clock rate of the video system. CLOCK should be driven by a dedicated TTL buffer.
25, 26 27, 31, 33	GND IOB, IOG, IOR	Ground. All GND pins must be connected. Differential Red, Green, and Blue Current Outputs (High Impedance Current Sources). These RGB video outputs are specified to directly drive RS-343A and RS-170 video levels into a doubly terminated 75 Ω load. If the complementary outputs are not required, these outputs should be tied to ground.
28, 32, 34	IOB, IOG, IOR	Red, Green, and Blue Current Outputs. These high impedance current sources are capable of directly driving a doubly terminated 75 Ω coaxial cable. All three current outputs should have similar output loads whether or not they are all being used.
35	COMP	Compensation Pin. This is a compensation pin for the internal reference amplifier. A 0.1 μF ceramic capacitor must be connected between COMP and V <sub>AA</sub> .
36	V <sub>REF</sub>	Voltage Reference Input for DACs or Voltage Reference Output (1.235 V).

Pin No.	Mnemonic	Description
37	R <sub>SET</sub>	<p>A resistor (R<sub>SET</sub>) connected between this pin and GND controls the magnitude of the full-scale video signal. Note that the IRE relationships are maintained, regardless of the full-scale output current. For nominal video levels into a doubly terminated 75 Ω load, R<sub>SET</sub> = 530 Ω. The relationship between R<sub>SET</sub> and the full-scale output current on IOG (assuming I<sub>SYNC</sub> is connected to IOG) is given by:</p> $R_{SET} (\Omega) = 11,445 \times V_{REF} (V) / IOG (mA)$ <p>The relationship between R<sub>SET</sub> and the full-scale output current on IOR, IOG, and IOB is given by:</p> $IOG (mA) = 11,445 \times V_{REF} (V) / R_{SET} (\Omega) \text{ (}\overline{SYNC} \text{ being asserted)}$ $IOR, IOB (mA) = 7989.6 \times V_{REF} (V) / R_{SET} (\Omega)$ <p>The equation for IOG is the same as that for IOR and IOB when <math>\overline{SYNC}</math> is not being used, that is, <math>\overline{SYNC}</math> tied permanently low.</p>
38	$\overline{PSAVE}$	Power Save Control Pin. Reduced power consumption is available on the ADV7123 when this pin is active.

# TYPICAL PERFORMANCE CHARACTERISTICS

## 5 V TYPICAL PERFORMANCE CHARACTERISTICS

$V_{AA} = 5\text{ V}$ ,  $V_{REF} = 1.235\text{ V}$ ,  $I_{OUT} = 17.62\text{ mA}$ ,  $50\ \Omega$  doubly terminated load, differential output loading,  $T_A = 25^\circ\text{C}$ , unless otherwise noted.

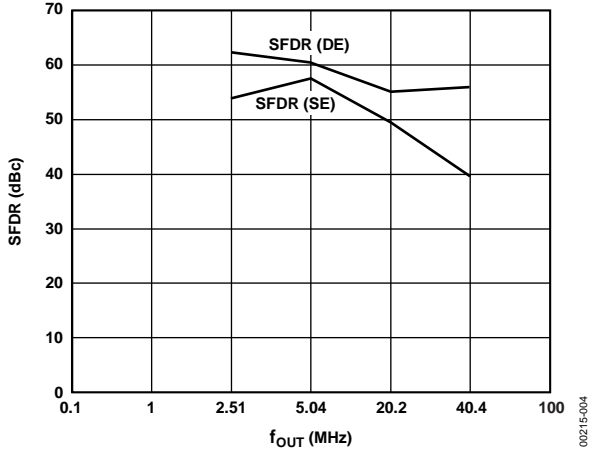

Figure 4. SFDR vs.  $f_{OUT}$  @  $f_{CLK} = 140\text{ MHz}$  (Single-Ended and Differential)

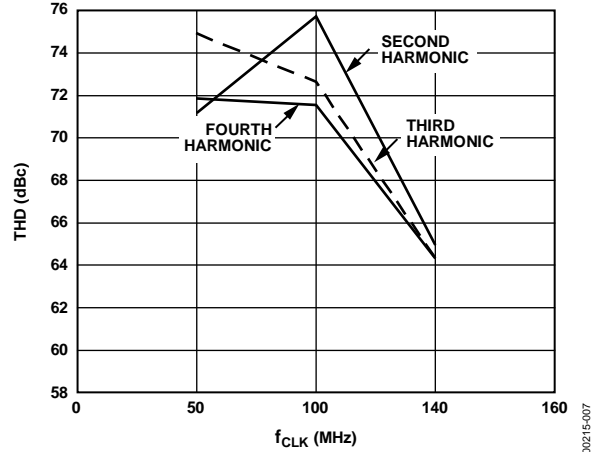

Figure 7. THD vs.  $f_{CLK}$  @  $f_{OUT} = 2\text{ MHz}$  (Second, Third, and Fourth Harmonics)

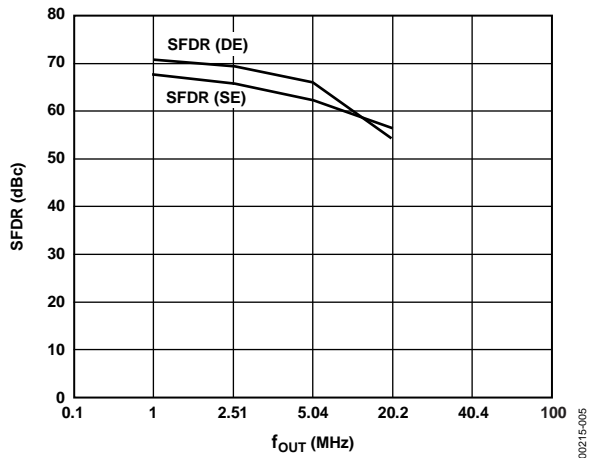

Figure 5. SFDR vs.  $f_{OUT}$  @  $f_{CLK} = 50\text{ MHz}$  (Single-Ended and Differential)

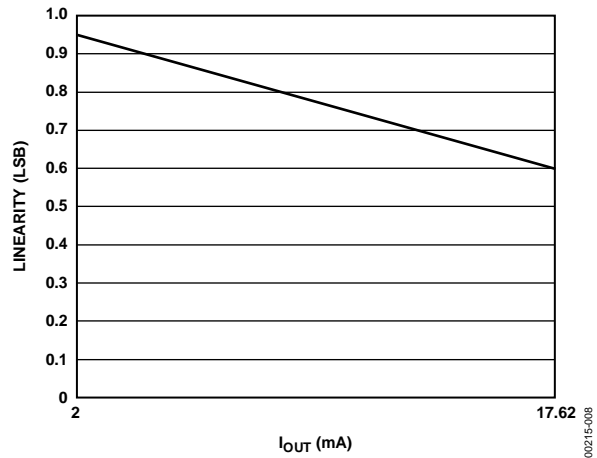

Figure 8. Linearity vs.  $I_{OUT}$

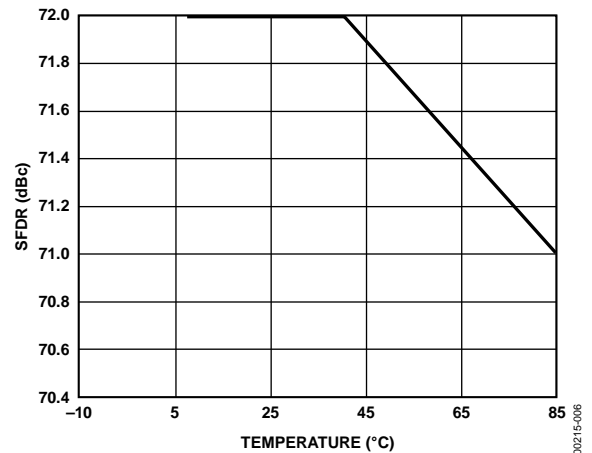

Figure 6. SFDR vs. Temperature @  $f_{CLK} = 50\text{ MHz}$  ( $f_{OUT} = 1\text{ MHz}$ )

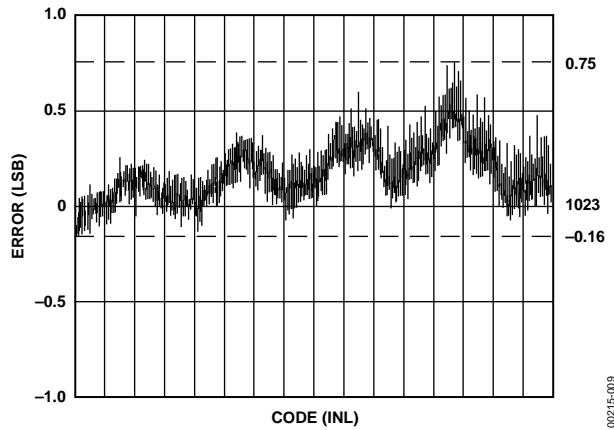

Figure 9. Typical Linearity (INL)

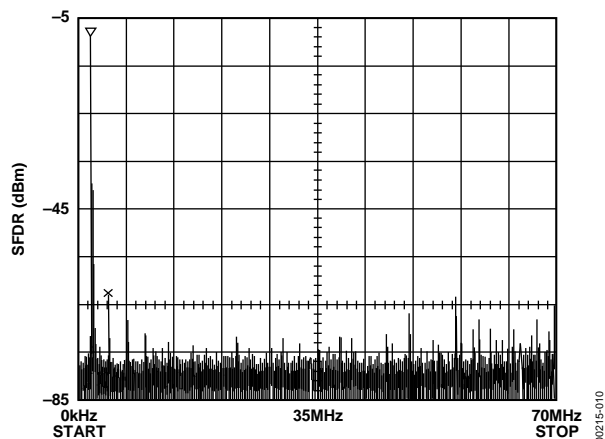

Figure 10. Single-Tone SFDR @  $f_{CLK} = 140 \text{ MHz}$  ( $f_{OUT} = 2 \text{ MHz}$ )

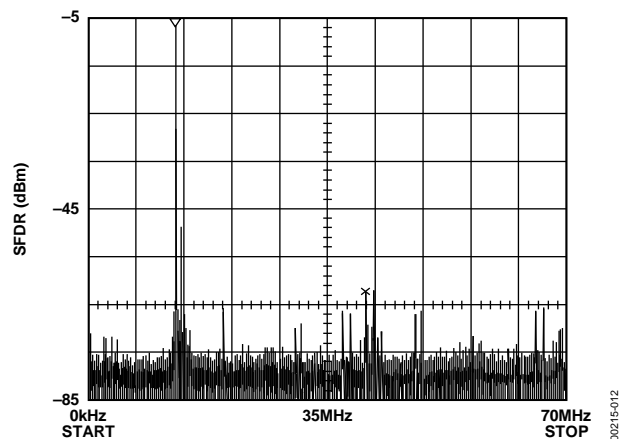

Figure 12. Dual-Tone SFDR @  $f_{CLK} = 140 \text{ MHz}$  ( $f_{OUT1} = 13.5 \text{ MHz}$ ,  $f_{OUT2} = 14.5 \text{ MHz}$ )

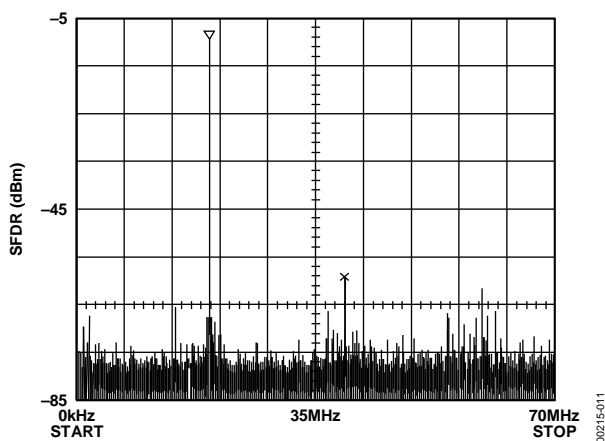

Figure 11. Single-Tone SFDR @  $f_{CLK} = 140 \text{ MHz}$  ( $f_{OUT} = 20 \text{ MHz}$ )

## 3 V TYPICAL PERFORMANCE CHARACTERISTICS

$V_{AA} = 3\text{ V}$ ,  $V_{REF} = 1.235\text{ V}$ ,  $I_{OUT} = 17.62\text{ mA}$ ,  $50\ \Omega$  doubly terminated load, differential output loading,  $T_A = 25^\circ\text{C}$ .

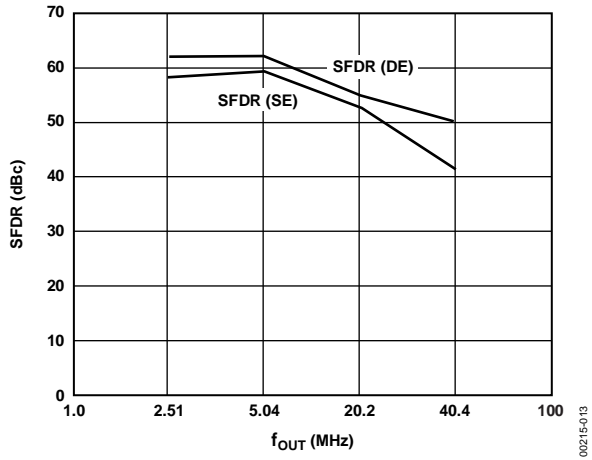

Figure 13. SFDR vs.  $f_{OUT}$  @  $f_{CLK} = 140\text{ MHz}$  (Single-Ended and Differential)

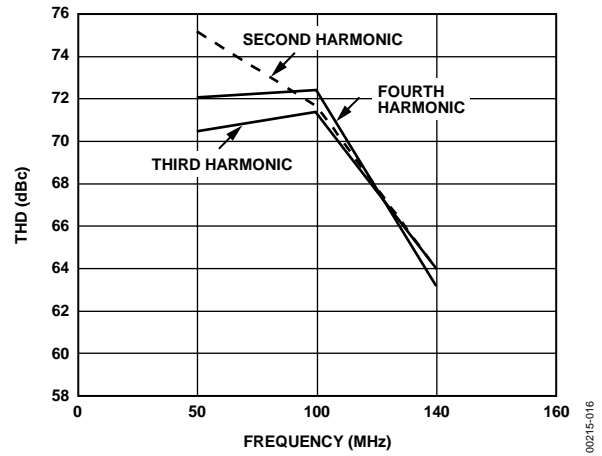

Figure 16. THD vs.  $f_{CLK}$  @  $f_{OUT} = 2\text{ MHz}$  (Second, Third, and Fourth Harmonics)

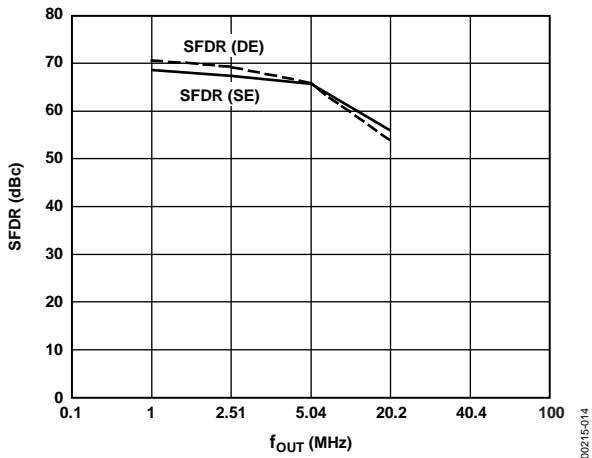

Figure 14. SFDR vs.  $f_{OUT}$  @  $f_{CLK} = 140\text{ MHz}$  (Single-Ended and Differential)

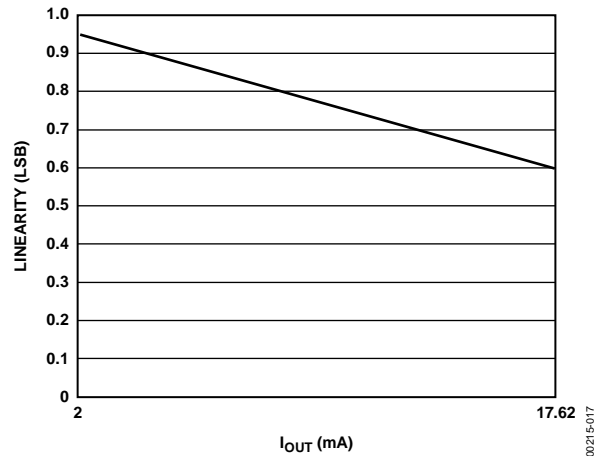

Figure 17. Linearity vs.  $I_{OUT}$

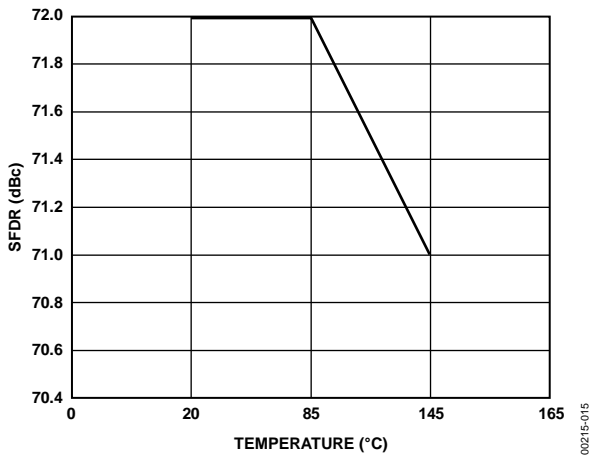

Figure 15. SFDR vs. Temperature @  $f_{CLK} = 50\text{ MHz}$ , ( $f_{OUT} = 1\text{ MHz}$ )

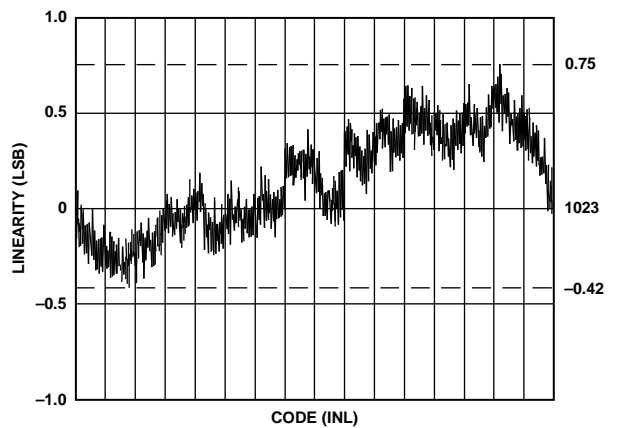

Figure 18. Typical Linearity

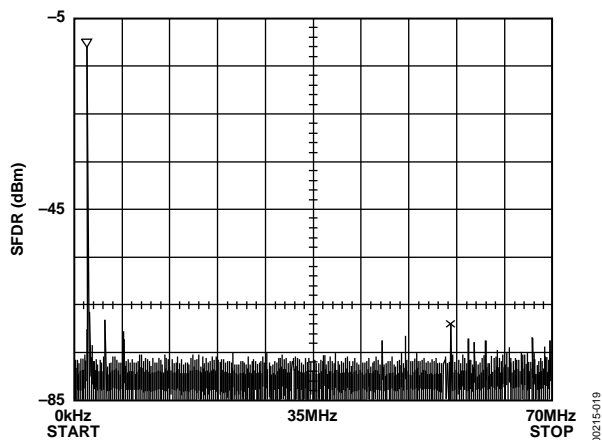

Figure 19. Single-Tone SFDR @  $f_{CLK} = 140$  MHz ( $f_{OUT} = 2$  MHz)

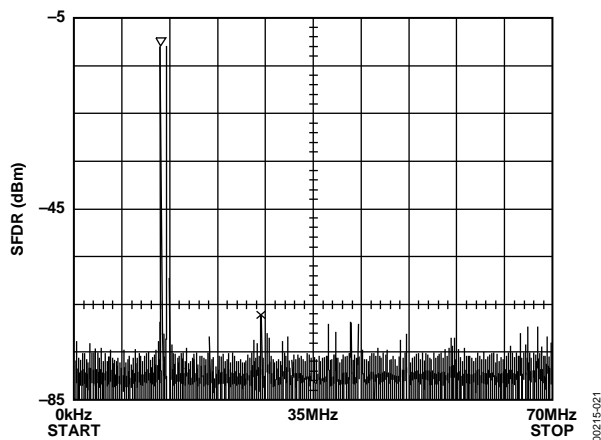

Figure 21. Dual-Tone SFDR @  $f_{CLK} = 140$  MHz ( $f_{OUT1} = 13.5$  MHz,  $f_{OUT2} = 14.5$  MHz)

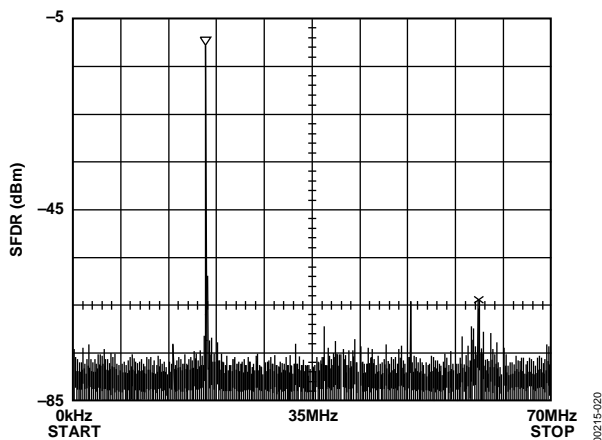

Figure 20. Single-Tone SFDR @  $f_{CLK} = 140$  MHz ( $f_{OUT} = 20$  MHz)

00215-019

00215-021

00215-020

## TERMINOLOGY

### **Blanking Level**

The level separating the SYNC portion from the video portion of the waveform. Usually referred to as the front porch or back porch. At 0 IRE units, it is the level that shuts off the picture tube, resulting in the blackest possible picture.

### **Color Video (RGB)**

This refers to the technique of combining the three primary colors of red, green, and blue to produce color pictures within the usual spectrum. In RGB monitors, three DACs are required, one for each color.

### **Sync Signal (SYNC)**

The position of the composite video signal that synchronizes the scanning process.

### **Gray Scale**

The discrete levels of video signal between reference black and reference white levels. A 10-bit DAC contains 1024 different levels, while an 8-bit DAC contains 256.

### **Raster Scan**

The most basic method of sweeping a CRT one line at a time to generate and display images.

### **Reference Black Level**

The maximum negative polarity amplitude of the video signal.

### **Reference White Level**

The maximum positive polarity amplitude of the video signal.

### **Sync Level**

The peak level of the SYNC signal.

### **Video Signal**

The portion of the composite video signal that varies in gray scale levels between reference white and reference black. Also referred to as the picture signal, this is the portion that can be visually observed.

## CIRCUIT DESCRIPTION AND OPERATION

The ADV7123 contains three 10-bit DACs, with three input channels, each containing a 10-bit register. Also integrated on board the part is a reference amplifier. The CRT control functions, BLANK and SYNC, are integrated on board the ADV7123.

### DIGITAL INPUTS

There are 30 bits of pixel data (color information), R0 to R9, G0 to G9, and B0 to B9, latched into the device on the rising edge of each clock cycle. This data is presented to the three 10-bit DACs and then converted to three analog (RGB) output waveforms (see Figure 22).

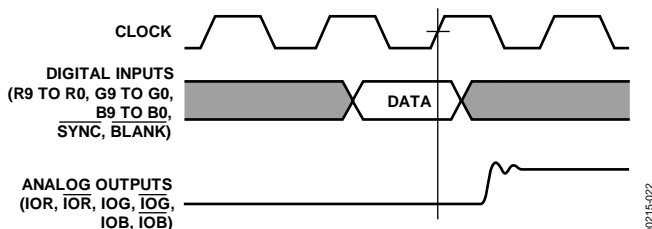
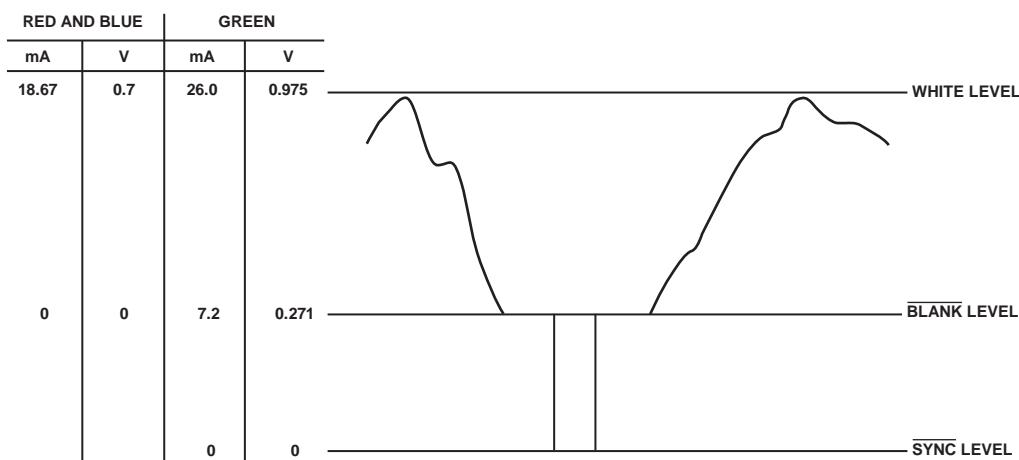

Figure 22. Video Data Input/Output

The ADV7123 has two additional control signals that are latched to the analog video outputs in a similar fashion. BLANK and SYNC are each latched on the rising edge of CLOCK to maintain synchronization with the pixel data stream.

The BLANK and SYNC functions allow for the encoding of these video synchronization signals onto the RGB video output.

This is done by adding appropriately weighted current sources to the analog outputs, as determined by the logic levels on the BLANK and SYNC digital inputs. Figure 23 shows the analog output, RGB video waveform of the ADV7123. The influence of SYNC and BLANK on the analog video waveform is illustrated.



- NOTES
1. OUTPUTS CONNECTED TO A DOUBLY TERMINATED 75Ω LOAD.
  2.  $V_{REF} = 1.235V$ ,  $R_{SET} = 530\Omega$ .
  3. RS-343 LEVELS AND TOLERANCES ASSUMED ON ALL LEVELS.

Figure 23. Typical RGB Video Output Waveform

Table 9 details the resultant effect on the analog outputs of BLANK and SYNC.

All these digital inputs are specified to accept TTL logic levels.

### CLOCK INPUT

The CLOCK input of the ADV7123 is typically the pixel clock rate of the system. It is also known as the dot rate. The dot rate, and thus the required CLOCK frequency, is determined by the on-screen resolution, according to the following equation:

$$\text{Dot Rate} = (\text{Horiz Res}) \times (\text{Vert Res}) \times (\text{Refresh Rate}) / (\text{Retrace Factor})$$

where:

*Horiz Res* is the number of pixels per line.

*Vert Res* is the number of lines per frame.

*Refresh Rate* is the horizontal scan rate. This is the rate at which the screen must be refreshed, typically 60 Hz for a noninterlaced system, or 30 Hz for an interlaced system.

*Retrace Factor* is the total blank time factor. This takes into account that the display is blanked for a certain fraction of the total duration of each frame (for example, 0.8).

Therefore, for a graphics system with a 1024 × 1024 resolution, a noninterlaced 60 Hz refresh rate, and a retrace factor of 0.8,

$$\text{Dot Rate} = 1024 \times 1024 \times 60 / 0.8 = 78.6 \text{ MHz}$$

The required CLOCK frequency is thus 78.6 MHz.

All video data and control inputs are latched into the ADV7123 on the rising edge of CLOCK, as described in the Digital Inputs section. It is recommended that the CLOCK input to the ADV7123 be driven by a TTL buffer (for example, 74F244).

**Table 9. Typical Video Output Truth Table ( $R_{SET} = 530 \Omega$ ,  $R_{LOAD} = 37.5 \Omega$ )**

Video Output Level	IOG (mA)	$\overline{\text{IOG}}$ (mA)	IOR/IOB (mA)	$\overline{\text{IOR/IOB}}$ (mA)	SYNC	BLANK	DAC Input Data
White Level	26.0	0	18.67	0	1	1	0x3FFH
Video	Video + 7.2	18.67 – Video	Video	18.67 – Video	1	1	Data
Video to $\overline{\text{BLANK}}$	Video	18.67 – Video	Video	18.67 – Video	0	1	Data
Black Level	7.2	18.67	0	18.67	1	1	0x000H
Black to $\overline{\text{BLANK}}$	0	18.67	0	18.67	0	1	0x000H
$\overline{\text{BLANK}}$ Level	7.2	18.67	0	18.67	1	0	0xXXXH (don't care)
$\overline{\text{SYNC}}$ Level	0	18.67	0	18.67	0	0	0xXXXH (don't care)

## VIDEO SYNCHRONIZATION AND CONTROL

The ADV7123 has a single composite sync ( $\overline{\text{SYNC}}$ ) input control. Many graphics processors and CRT controllers have the ability of generating horizontal sync (HSYNC), vertical sync (VSYNC), and composite  $\overline{\text{SYNC}}$ .

In a graphics system that does not automatically generate a composite  $\overline{\text{SYNC}}$  signal, the inclusion of some additional logic circuitry enables the generation of a composite  $\overline{\text{SYNC}}$  signal.

The sync current is internally connected directly to the IOG output, thus encoding video synchronization information onto the green video channel. If it is not required to encode sync information onto the ADV7123, the  $\overline{\text{SYNC}}$  input should be tied to logic low.

## REFERENCE INPUT

The ADV7123 contains an on-board voltage reference. The  $V_{REF}$  pin is normally terminated to  $V_{AA}$  through a 0.1  $\mu\text{F}$  capacitor. Alternatively, the part can, if required, be overdriven by an external 1.23 V reference (AD1580).

A resistance,  $R_{SET}$ , connected between the  $R_{SET}$  pin and GND, determines the amplitude of the output video level according to Equation 1 and Equation 2 for the ADV7123.

$$\text{IOG (mA)} = 11,445 \times V_{REF} (\text{V}) / R_{SET} (\Omega) \quad (1)$$

$$\text{IOR, IOB (mA)} = 7989.6 \times V_{REF} (\text{V}) / R_{SET} (\Omega) \quad (2)$$

Equation 1 applies to the ADV7123 only, when  $\overline{\text{SYNC}}$  is being used. If  $\overline{\text{SYNC}}$  is not being encoded onto the green channel, Equation 1 is similar to Equation 2.

Using a variable value of  $R_{SET}$  allows for accurate adjustment of the analog output video levels. Use of a fixed 560  $\Omega$   $R_{SET}$  resistor yields the analog output levels quoted in the Specifications section. These values typically correspond to the RS-343A video waveform values, as shown in Figure 23.

## DACs

The ADV7123 contains three matched 10-bit DACs. The DACs are designed using an advanced, high speed, segmented architecture. The bit currents corresponding to each digital input are routed to either the analog output (bit = 1) or GND (bit = 0) by a sophisticated decoding scheme. Because all this circuitry is on one monolithic device, matching between the three DACs is optimized. As well as matching, the use of identical current

sources in a monolithic design guarantees monotonicity and low glitch. The on-board operational amplifier stabilizes the full-scale output current against temperature and power supply variations.

## ANALOG OUTPUTS

The ADV7123 has three analog outputs, corresponding to the red, green, and blue video signals.

The red, green, and blue analog outputs of the ADV7123 are high impedance current sources. Each one of these three RGB current outputs is capable of directly driving a 37.5  $\Omega$  load, such as a doubly terminated 75  $\Omega$  coaxial cable. Figure 24 shows the required configuration for each of the three RGB outputs connected into a doubly terminated 75  $\Omega$  load. This arrangement develops RS-343A video output voltage levels across a 75  $\Omega$  monitor.

A suggested method of driving RS-170 video levels into a 75  $\Omega$  monitor is shown in Figure 25. The output current levels of the DACs remain unchanged, but the source termination resistance,  $Z_S$ , on each of the three DACs is increased from 75  $\Omega$  to 150  $\Omega$ .

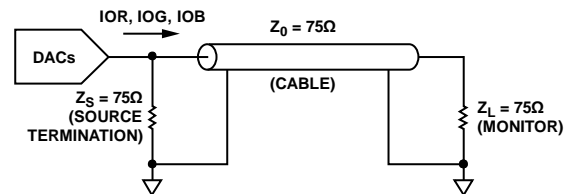

TERMINATION REPEATED THREE TIMES FOR RED, GREEN, AND BLUE DACs

Figure 24. Analog Output Termination for RS-343A

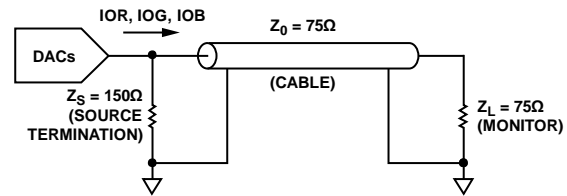

TERMINATION REPEATED THREE TIMES FOR RED, GREEN, AND BLUE DACs

Figure 25. Analog Output Termination for RS-170

More detailed information regarding load terminations for various output configurations, including RS-343A and RS-170, is available in the AN-205 Application Note, *Video Formats and Required Load Terminations*, available from Analog Devices, at [www.analog.com](http://www.analog.com).

Figure 23 shows the video waveforms associated with the three RGB outputs driving the doubly terminated 75 Ω load of Figure 24. As well as the gray scale levels, black level to white level, Figure 23 also shows the contributions of SYNC and BLANK for the ADV7123. These control inputs add appropriately weighted currents to the analog outputs, producing the specific output level requirements for video applications. Table 9 details how the SYNC and BLANK inputs modify the output levels.

## GRAY SCALE OPERATION

The ADV7123 can be used for standalone, gray scale (monochrome), or composite video applications (that is, only one channel used for video information). Any one of the three channels, red, green, or blue, can be used to input the digital video data. The two unused video data channels should be tied to Logic 0. The unused analog outputs should be terminated with the same load as that for the used channel; that is, if the red channel is used and IOR is terminated with a doubly terminated 75 Ω load (37.5 Ω), IOB and IOG should be terminated with 37.5 Ω resistors (see Figure 26).

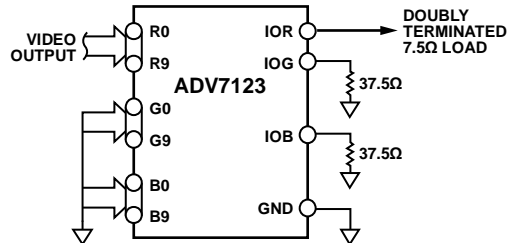

Figure 26. Input and Output Connections for Standalone Gray Scale or Composite Video

## VIDEO OUTPUT BUFFERS

The ADV7123 is specified to drive transmission line loads. The analog output configuration to drive such loads is described in the Analog Outputs section and illustrated in Figure 27. However, in some applications it may be required to drive long transmission line cable lengths. Cable lengths greater than 10 meters can attenuate and distort high frequency analog output pulses. The inclusion of output buffers compensates for some cable distortion. Buffers with large full power bandwidths and gains between two and four are required. These buffers also need to be able to supply sufficient current over the complete output voltage swing. Analog Devices produces a range of suitable op amps for such applications. These include the AD843, AD844, AD847, and AD848 series of monolithic op amps. In very high frequency applications (80 MHz), the AD8061 is recommended. More information on line driver buffering circuits is given in the relevant op amp data sheets.

Use of buffer amplifiers also allows implementation of other video standards besides RS-343A and RS-170. Altering the gain components of the buffer circuit results in any desired video level.

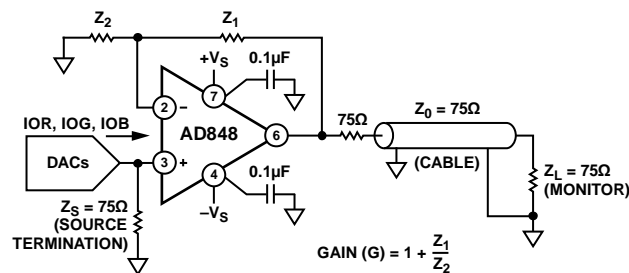

Figure 27. AD848 As an Output Buffer

## PCB LAYOUT CONSIDERATIONS

The ADV7123 is optimally designed for lowest noise performance, both radiated and conducted noise. To complement the excellent noise performance of the ADV7123, it is imperative that great care be given to the PCB layout. Figure 28 shows a recommended connection diagram for the ADV7123.

The layout should be optimized for lowest noise on the ADV7123 power and ground lines. This can be achieved by shielding the digital inputs and providing good decoupling. Shorten the lead length between groups of V<sub>AA</sub> and GND pins to minimize inductive ringing.

It is recommended to use a 4-layer printed circuit board with a single ground plane. The ground and power planes should separate the signal trace layer and the solder side layer. Noise on the analog power plane can be further reduced by using multiple decoupling capacitors (see Figure 28). Optimum performance is achieved by using 0.1 μF and 0.01 μF ceramic capacitors. Individually decouple each V<sub>AA</sub> pin to ground by placing the capacitors as close as possible to the device with the capacitor leads as short as possible, thus minimizing lead inductance. It is important to note that while the ADV7123 contains circuitry to reject power supply noise, this rejection decreases with frequency. If a high frequency switching power supply is used, pay close attention to reducing power supply noise. A dc power supply filter (Murata BNX002) provides EMI suppression between the switching power supply and the main PCB. Alternatively, consideration can be given to using a 3-terminal voltage regulator.

## DIGITAL SIGNAL INTERCONNECT

Isolate the digital signal lines to the ADV7123 as much as possible from the analog outputs and other analog circuitry. Digital signal lines should not overlay the analog power plane.

Due to the high clock rates used, long clock lines to the ADV7123 should be avoided to minimize noise pickup.

Connect any active pull-up termination resistors for the digital inputs to the regular PCB power plane (V<sub>CC</sub>) and not the analog power plane.

# ADV7123

## ANALOG SIGNAL INTERCONNECT

Place the ADV7123 as close as possible to the output connectors, thus minimizing noise pickup and reflections due to impedance mismatch.

The video output signals should overlay the ground plane and not the analog power plane, thereby maximizing the high frequency power supply rejection.

For optimum performance, the analog outputs should each have a source termination resistance to ground of 75  $\Omega$  (doubly terminated 75  $\Omega$  configuration). This termination resistance should be as close as possible to the ADV7123 to minimize reflections.

Additional information on PCB design is available in the AN-333 Application Note, *Design and Layout of a Video Graphics System for Reduced EMI*, which is available from Analog Devices at [www.analog.com](http://www.analog.com).

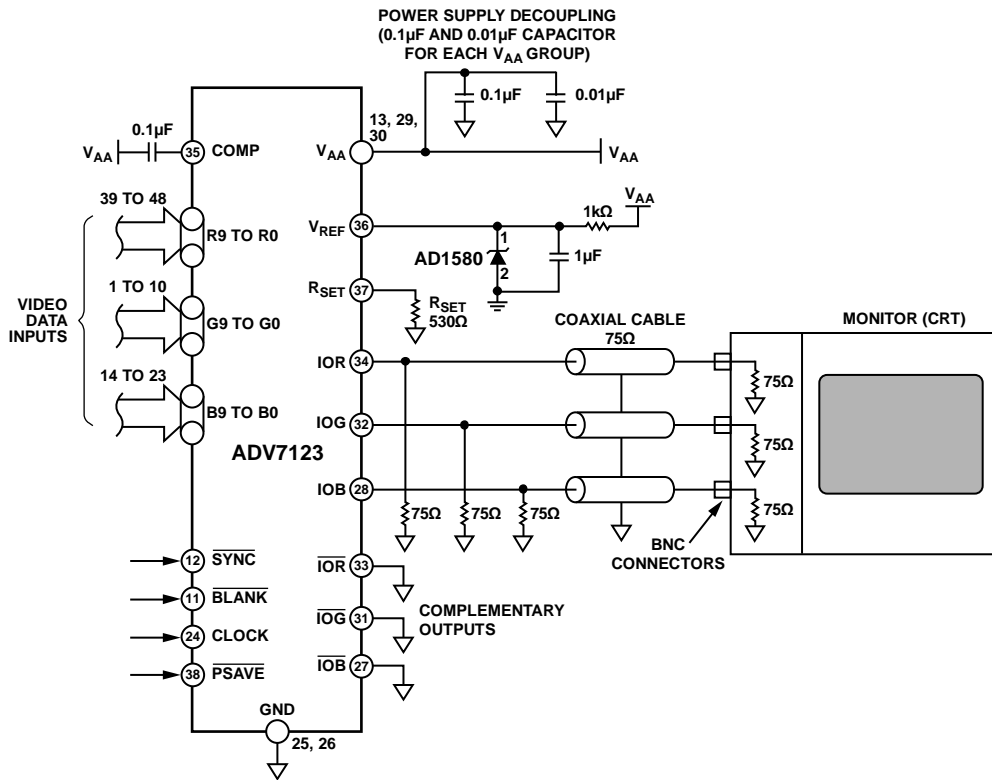
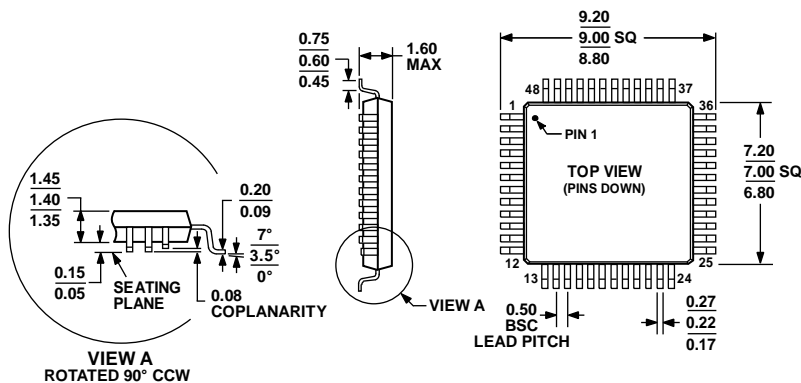

Figure 28. Typical Connection Diagram

00215-028

# OUTLINE DIMENSIONS



COMPLIANT TO JEDEC STANDARDS MS-026-BBC

Figure 29. 48-Lead Low Profile Quad Flat Package [LQFP] (ST-48)

Dimensions shown in millimeters

051706-A

## ORDERING GUIDE

Model <sup>1, 2</sup>	Temperature Range	Speed Option	Package Description	Package Option
ADV7123KSTZ50	-40°C to +85°C	50 MHz	48-Lead LQFP	ST-48
ADV7123KSTZ140	-40°C to +85°C	140 MHz	48-Lead LQFP	ST-48
ADV7123KST140-RL	-40°C to +85°C	140 MHz	48-Lead LQFP	ST-48
ADV7123JSTZ240	0°C to 70°C	240 MHz	48-Lead LQFP	ST-48
ADV7123JSTZ240-RL	0°C to 70°C	240 MHz	48-Lead LQFP	ST-48
ADV7123JSTZ330	0°C to 70°C	330 MHz	48-Lead LQFP	ST-48

<sup>1</sup> Z = RoHS Compliant Part.

<sup>2</sup> ADV7123JSTZ330 is available in a 3.3 V version only.

**ADV7123**

**NOTES**

**NOTES**

**ADV7123**

**NOTES**

## Looking for pricing, stock, or lifecycle information?

Click below to explore more details on WIN SOURCE:

 [View ADV7123JSTZ330 on WIN SOURCE](#)

 [Analog Devices Inc. Information](#)

## Optimize Your Supply Chain with WIN SOURCE Solutions

-  Global Sourcing Solution
-  Obsolete Management
-  Cost Control Management
-  Shortage Management
-  Alternative Solution
-  Excess Inventory Management