



THE DATASHEET OF FOD817AW





ON Semiconductor®

FOD814 Series, FOD817 Series 4-Pin DIP Phototransistor Optocouplers

Features

- AC Input Response (FOD814)
- Current Transfer Ratio in Selected Groups:

FOD814: 20–300%	FOD817: 50–600%
FOD814A: 50–150%	FOD817A: 80–160%
	FOD817B: 130–260%
	FOD817C: 200–400%
	FOD817D: 300–600%
- Minimum BV_{CEO} of 70 V Guaranteed
- Safety and Regulatory Approvals
 - UL1577, 5,000 $V_{AC_{RMS}}$ for 1 Minute
 - DIN EN/IEC60747-5-5

Applications

FOD814 Series

- AC Line Monitor
- Unknown Polarity DC Sensor
- Telephone Line Interface

FOD817 Series

- Power Supply Regulators
- Digital Logic Inputs
- Microprocessor Inputs

Description

The FOD814 consists of two gallium arsenide infrared emitting diodes, connected in inverse parallel, driving a silicon phototransistor output in a 4-pin dual in-line package. The FOD817 Series consists of a gallium arsenide infrared emitting diode driving a silicon phototransistor in a 4-pin dual in-line package.

Functional Block Diagram

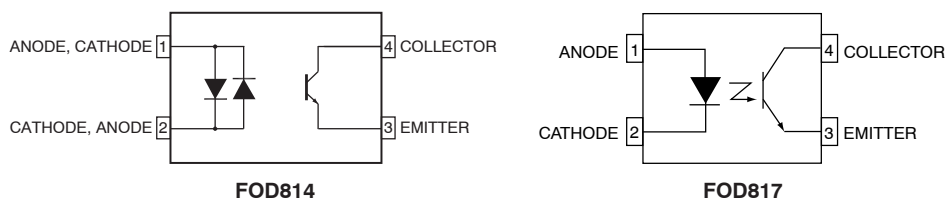

Figure 1. Schematic

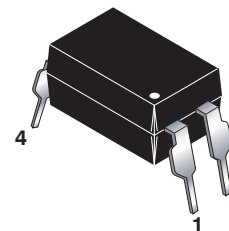

Figure 2. Package Outlines

Safety and Insulation Ratings

As per DIN EN/IEC 60747-5-5, this optocoupler is suitable for “safe electrical insulation” only within the safety limit data. Compliance with the safety ratings shall be ensured by means of protective circuits.

Parameter		Characteristics
Installation Classifications per DIN VDE 0110/1.89 Table 1, For Rated Mains Voltage	< 150 V _{RMS}	I–IV
	< 300 V _{RMS}	I–III
Climatic Classification		30/110/21
Pollution Degree (DIN VDE 0110/1.89)		2
Comparative Tracking Index		175

Symbol	Parameter	Value	Unit
V _{PR}	Input-to-Output Test Voltage, Method A, V _{IORM} × 1.6 = V _{PR} , Type and Sample Test with t _m = 10 s, Partial Discharge < 5 pC	1360	V _{peak}
	Input-to-Output Test Voltage, Method B, V _{IORM} × 1.875 = V _{PR} , 100% Production Test with t _m = 1 s, Partial Discharge < 5 pC	1594	V _{peak}
V _{IORM}	Maximum Working Insulation Voltage	850	V _{peak}
V _{IOTM}	Highest Allowable Over-Voltage	8000	V _{peak}
	External Creepage	≥ 7	mm
	External Clearance	≥ 7	mm
	External Clearance (for Option W, 0.4" Lead Spacing)	≥ 10	mm
DTI	Distance Through Insulation (Insulation Thickness)	≥ 0.4	mm
T _S	Case Temperature ⁽¹⁾	175	°C
I _{S,INPUT}	Input Current ⁽¹⁾	400	mA
P _{S,OUTPUT}	Output Power ⁽¹⁾	700	mW
R _{IO}	Insulation Resistance at T _S , V _{IO} = 500 V ⁽¹⁾	> 10 ¹¹	Ω

Note:

1. Safety limit values – maximum values allowed in the event of a failure.

Absolute Maximum Ratings

Stresses exceeding the absolute maximum ratings may damage the device. The device may not function or be operable above the recommended operating conditions and stressing the parts to these levels is not recommended. In addition, extended exposure to stresses above the recommended operating conditions may affect device reliability. The absolute maximum ratings are stress ratings only. $T_A = 25^\circ\text{C}$ Unless otherwise specified.

Symbol	Parameter	Value		Unit
		FOD814	FOD817	
Total Device				
T_{STG}	Storage Temperature	-55 to +150		$^\circ\text{C}$
T_{OPR}	Operating Temperature	-55 to +105	-55 to +110	$^\circ\text{C}$
T_J	Junction Temperature	-55 to +125		$^\circ\text{C}$
T_{SOL}	Lead Solder Temperature	260 for 10 seconds		$^\circ\text{C}$
θ_{JC}	Junction-to-Case Thermal Resistance	210		$^\circ\text{C}/\text{W}$
P_{TOT}	Total Device Power Dissipation	200		mW
EMITTER				
I_F	Continuous Forward Current	± 50	50	mA
V_R	Reverse Voltage		6	V
P_D	Power Dissipation	70		mW
	Derate Above 100°C	1.7		mW/ $^\circ\text{C}$
DETECTOR				
V_{CEO}	Collector-Emitter Voltage	70		V
V_{ECO}	Emitter-Collector Voltage	6		V
I_C	Continuous Collector Current	50		mA
P_C	Collector Power Dissipation	150		mW
	Derate Above 90°C	2.9		mW/ $^\circ\text{C}$

Electrical Characteristics

$T_A = 25^\circ\text{C}$ unless otherwise specified.

Individual Component Characteristics

Symbol	Parameter	Device	Test Conditions	Min.	Typ.	Max.	Unit
EMITTER							
V_F	Forward Voltage	FOD814	$I_F = \pm 20\text{ mA}$		1.2	1.4	V
		FOD817	$I_F = 20\text{ mA}$		1.2	1.4	
I_R	Reverse Current	FOD817	$V_R = 4.0\text{ V}$			10	μA
C_t	Terminal Capacitance	FOD814	$V = 0, f = 1\text{ kHz}$		50	250	pF
		FOD817	$V = 0, f = 1\text{ kHz}$		30	250	
DETECTOR							
I_{CEO}	Collector Dark Current	FOD814	$V_{CE} = 20\text{ V}, I_F = 0$			100	nA
		FOD817	$V_{CE} = 20\text{ V}, I_F = 0$			100	
BV_{CEO}	Collector-Emitter Breakdown Voltage	FOD814	$I_C = 0.1\text{ mA}, I_F = 0$	70			V
		FOD817	$I_C = 0.1\text{ mA}, I_F = 0$	70			
BV_{ECO}	Emitter-Collector Breakdown Voltage	FOD814	$I_E = 10\text{ }\mu\text{A}, I_F = 0$	6			V
		FOD817	$I_E = 10\text{ }\mu\text{A}, I_F = 0$	6			

DC Transfer Characteristics

Symbol	Parameter	Device	Test Conditions	Min.	Typ.	Max.	Unit
CTR	Current Transfer Ratio ⁽²⁾	FOD814	$I_F = \pm 1\text{ mA}, V_{CE} = 5\text{ V}$	20		300	%
		FOD814A		50		150	
		FOD817	$I_F = 5\text{ mA}, V_{CE} = 5\text{ V}$	50		600	
		FOD817A		80		160	
		FOD817B		130		260	
		FOD817C		200		400	
		FOD817D		300		600	
$V_{CE(SAT)}$	Collector-Emitter Saturation Voltage	FOD814	$I_F = \pm 20\text{ mA}, I_C = 1\text{ mA}$		0.1	0.2	V
		FOD817	$I_F = 20\text{ mA}, I_C = 1\text{ mA}$		0.1	0.2	

AC Transfer Characteristics

Symbol	Parameter	Device	Test Conditions	Min.	Typ.	Max.	Unit
f_C	Cut-Off Frequency	FOD814	$V_{CE} = 5\text{ V}, I_C = 2\text{ mA}, R_L = 100\text{ }\Omega, -3\text{ dB}$	15	80		kHz
t_r	Response Time (Rise)	FOD814, FOD817	$V_{CE} = 2\text{ V}, I_C = 2\text{ mA}, R_L = 100\text{ }\Omega$ ⁽³⁾		4	18	μs
t_f	Response Time (Fall)	FOD814, FOD817			3	18	μs

Notes:

- Current Transfer Ratio (CTR) = $I_C / I_F \times 100\%$.
- For test circuit setup and waveforms, refer to page 7.

Electrical Characteristics (Continued) $T_A = 25^\circ\text{C}$ unless otherwise specified.**Isolation Characteristics**

Symbol	Parameter	Device	Test Conditions	Min.	Typ.	Max.	Unit
V_{ISO}	Input-Output Isolation Voltage ⁽⁴⁾	FOD814, FOD817	$f = 60 \text{ Hz}$, $t = 1 \text{ minute}$, $I_{\text{I-O}} \leq 2 \mu\text{A}$	5000			VAC_{RMS}
R_{ISO}	Isolation Resistance	FOD814, FOD817	$V_{\text{I-O}} = 500 \text{ V}_{\text{DC}}$	5×10^{10}	1×10^{11}		Ω
C_{ISO}	Isolation Capacitance	FOD814, FOD817	$V_{\text{I-O}} = 0$, $f = 1 \text{ MHz}$		0.6	1.0	pf

Note:

4. For this test, Pins 1 and 2 are common, and Pins 3 and 4 are common.

Typical Electrical/Optical Characteristic Curves

$T_A = 25^\circ\text{C}$ unless otherwise specified.

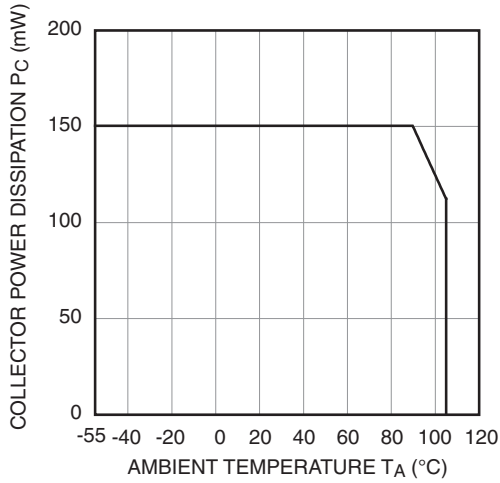

Fig. 3 Collector Power Dissipation vs. Ambient Temperature (FOD814)

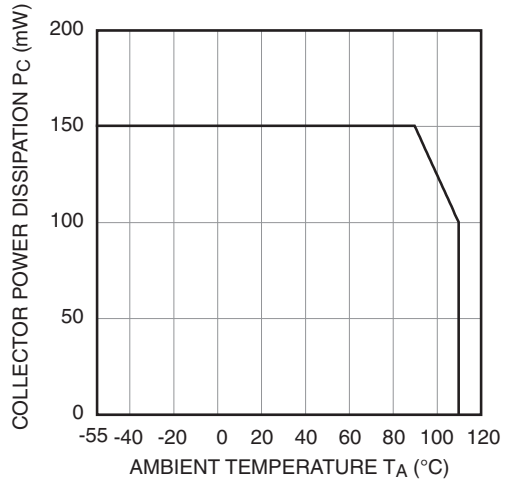

Fig. 4 Collector Power Dissipation vs. Ambient Temperature (FOD817)

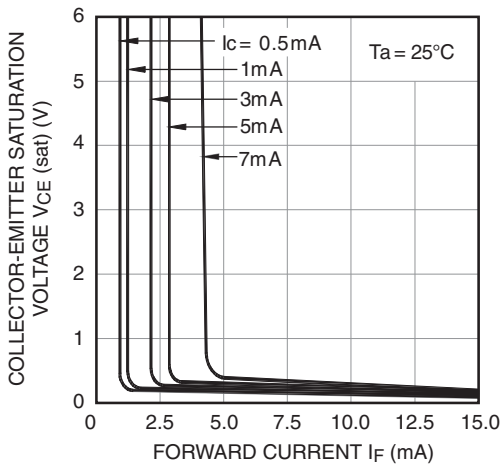

Fig. 5 Collector-Emitter Saturation Voltage vs. Forward Current

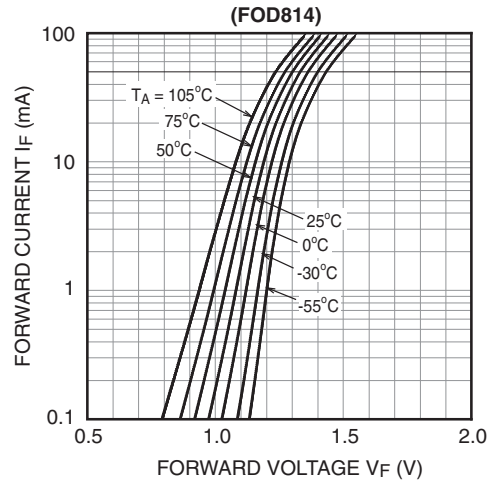

Fig. 6 Forward Current vs. Forward Voltage

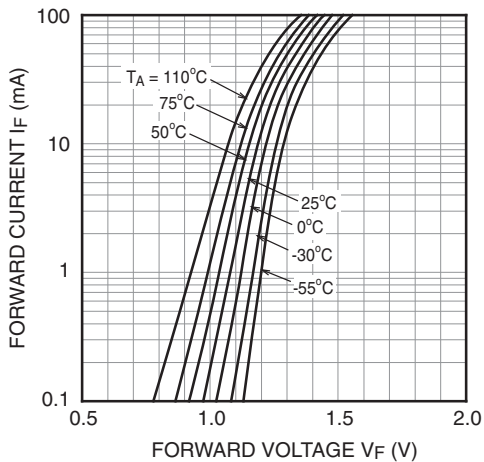

Fig. 7 Forward Current vs. Forward Voltage (FOD817)

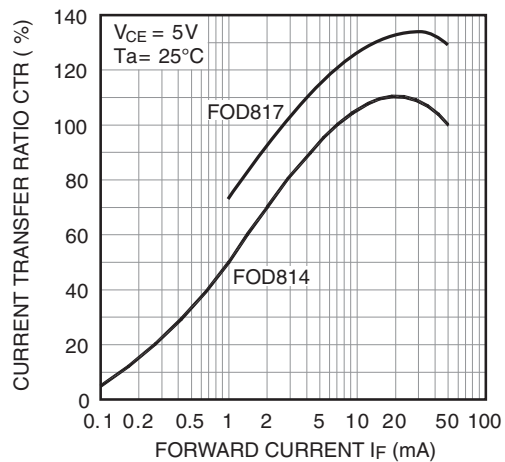

Fig. 8 Current Transfer Ratio vs. Forward Current

Typical Electrical/Optical Characteristic Curves (Continued)

$T_A = 25^\circ\text{C}$ unless otherwise specified.

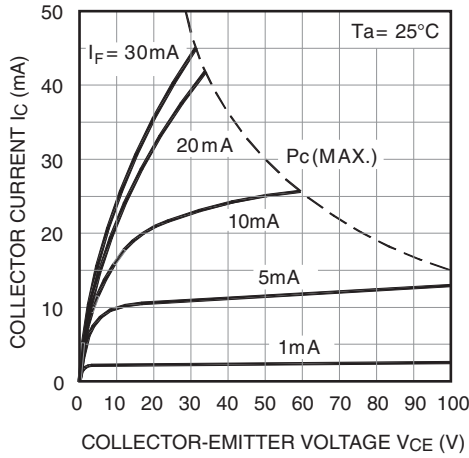

Fig. 9 Collector Current vs. Collector-Emitter Voltage (FOD814)

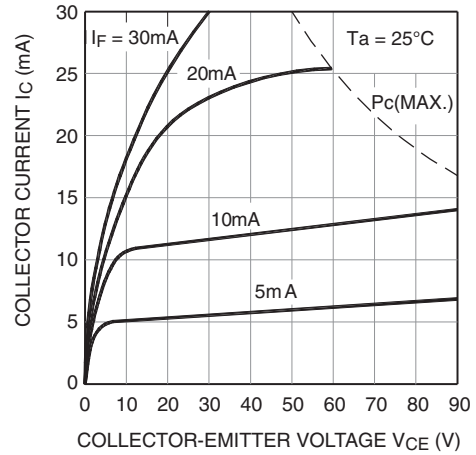

Fig. 10 Collector Current vs. Collector-Emitter Voltage (FOD817)

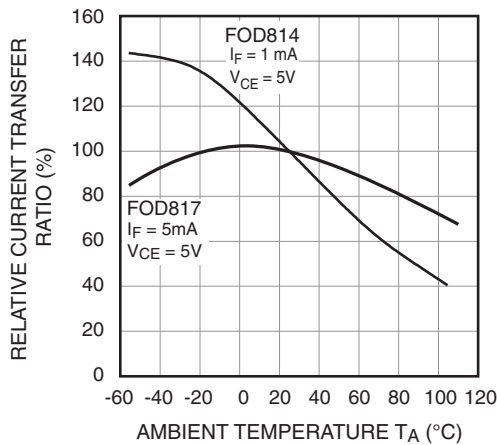

Fig. 11 Relative Current Transfer Ratio vs. Ambient Temperature

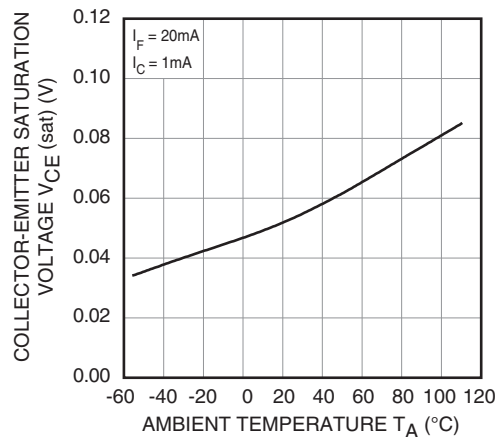

Fig. 12 Collector-Emitter Saturation Voltage vs. Ambient Temperature

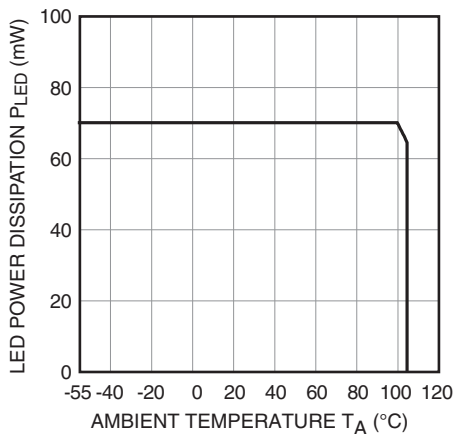

Fig. 13 LED Power Dissipation vs. Ambient Temperature (FOD814)

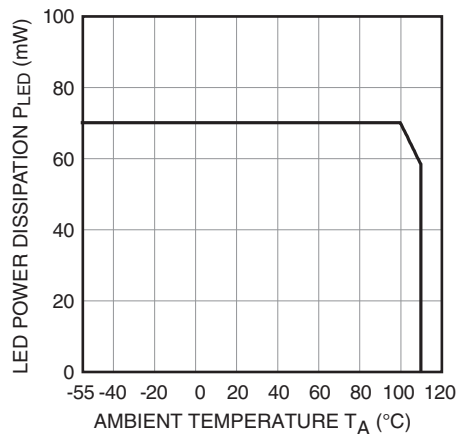

Fig. 14 LED Power Dissipation vs. Ambient Temperature (FOD817)

Typical Electrical/Optical Characteristic Curves (Continued)

$T_A = 25^\circ\text{C}$ unless otherwise specified.

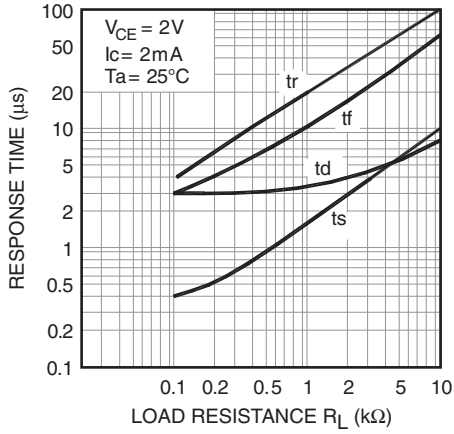

Fig. 15 Response Time vs. Load Resistance

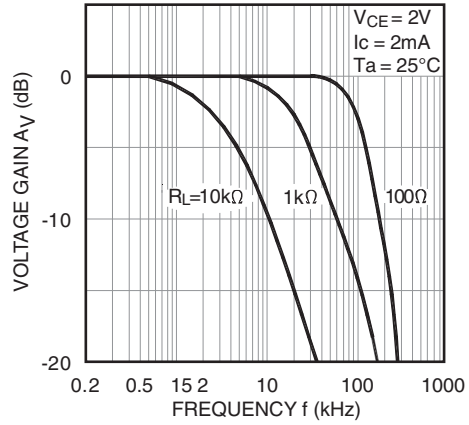

Fig. 16 Frequency Response

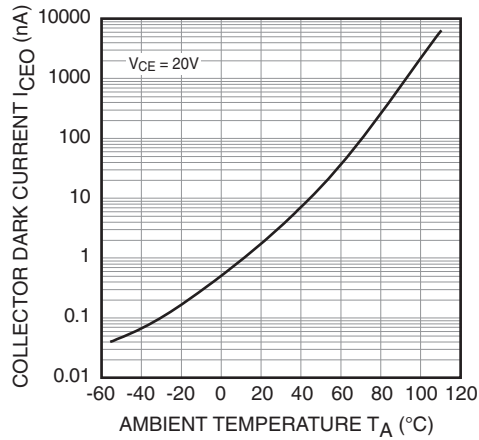
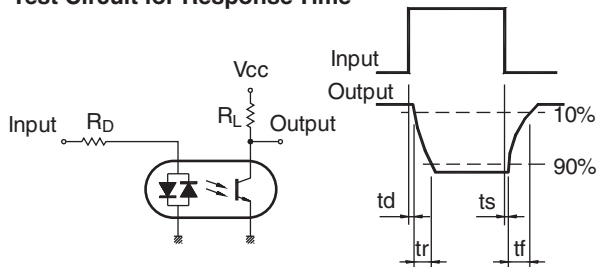
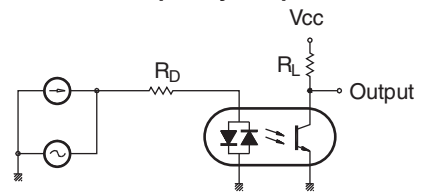

Fig. 17 Collector Dark Current vs. Ambient Temperature

Test Circuit for Response Time



Test Circuit for Frequency Response



Reflow Profile

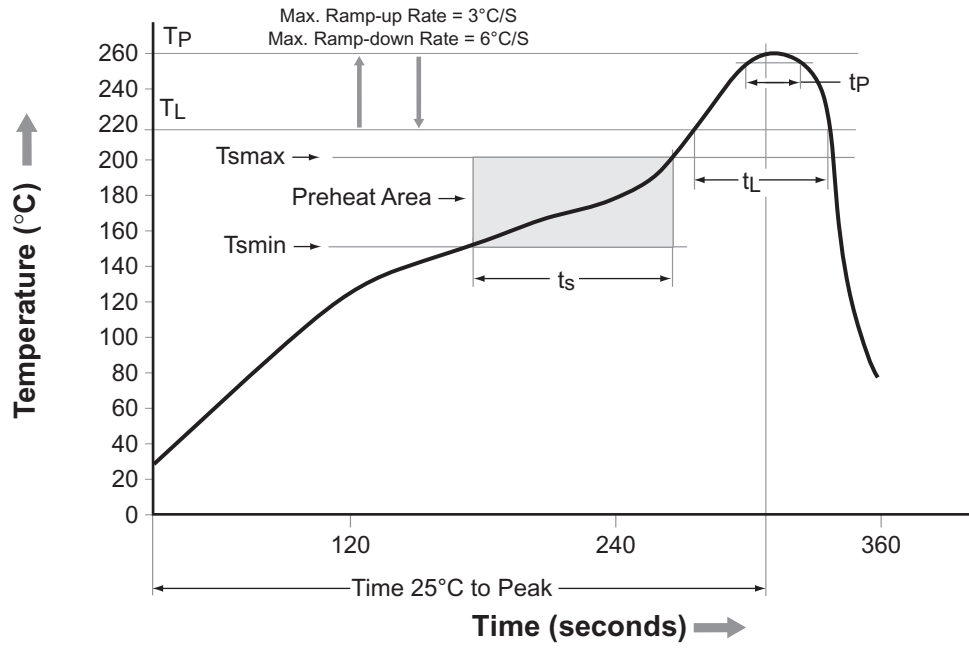

Profile Feature	Pb-Free Assembly Profile
Temperature Min. (Tsmmin)	150°C
Temperature Max. (Tsmmax)	200°C
Time (ts) from (Tsmmin to Tsmmax)	60–120 seconds
Ramp-up Rate (tL to tp)	3°C/second max.
Liquidous Temperature (TL)	217°C
Time (tL) Maintained Above (TL)	60–150 seconds
Peak Body Package Temperature	260°C +0°C / -5°C
Time (tp) within 5°C of 260°C	30 seconds
Ramp-down Rate (TP to TL)	6°C/second max.
Time 25°C to Peak Temperature	8 minutes max.

Figure 20. Reflow Profile

Ordering Information

Part Number	Package	Packing Method
FOD817X	DIP 4-Pin	Tube (100 units per tube)
FOD817XS	SMT 4-Pin (Lead Bend)	Tube (100 units per tube)
FOD817XSD	SMT 4-Pin (Lead Bend)	Tape and Reel (1,000 units per reel)
FOD817X300	DIP 4-Pin, DIN EN/IEC60747-5-5 option	Tube (100 units per tube)
FOD817X3S	SMT 4-Pin (Lead Bend), DIN EN/IEC60747-5-5 option	Tube (100 units per tube)
FOD817X3SD	SMT 4-Pin (Lead Bend), DIN EN/IEC60747-5-5 option	Tape and Reel (1,000 units per reel)
FOD817X300W	DIP 4-Pin, 0.4" Lead Spacing, DIN EN/IEC60747-5-5 option	Tube (100 units per tube)

Note:

The product orderable part number system listed in this table also applies to the FOD814 products.

"X" denotes the Current Transfer Ratio (CTR) options

Marking Information

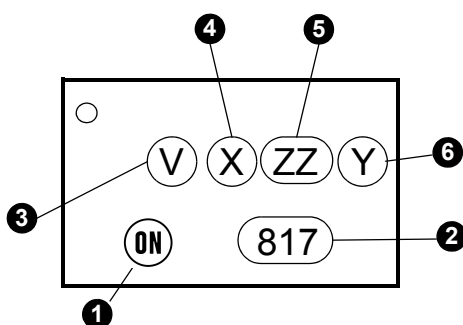

Figure 21. Top Mark

Definitions	
1	ON Semiconductor Logo
2	Device Number
3	VDE Mark (Note: Only appears on parts ordered with VDE option. See order entry table)
4	One Digit Year Code
5	Two Digit Work Week Ranging from '01' to '53'
6	Assembly Package Code

Carrier Tape Specifications

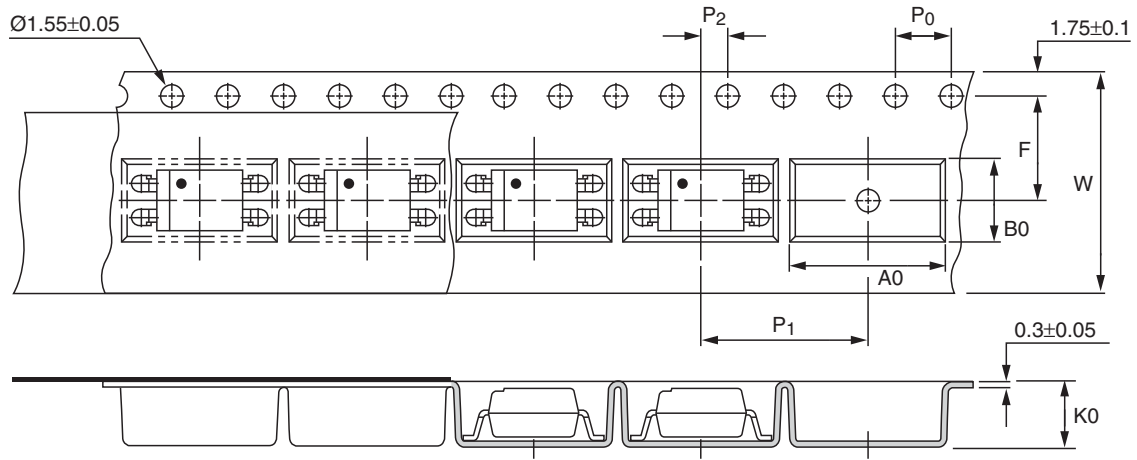

Figure 22. Carrier Tape Specification

Symbol	Description	Dimensions in mm (inches)
W	Tape wide	16 ± 0.3 (0.63)
P ₀	Pitch of sprocket holes	4 ± 0.1 (0.15)
F	Distance of compartment	7.5 ± 0.1 (0.295)
P ₂		2 ± 0.1 (0.079)
P ₁	Distance of compartment to compartment	12 ± 0.1 (0.472)
A ₀	Compartment	10.45 ± 0.1 (0.411)
B ₀		5.30 ± 0.1 (0.209)
K ₀		4.25 ± 0.1 (0.167)

ON Semiconductor and  are trademarks of Semiconductor Components Industries, LLC dba ON Semiconductor or its subsidiaries in the United States and/or other countries. ON Semiconductor owns the rights to a number of patents, trademarks, copyrights, trade secrets, and other intellectual property. A listing of ON Semiconductor's product/patent coverage may be accessed at www.onsemi.com/site/pdf/Patent-Marking.pdf. ON Semiconductor reserves the right to make changes without further notice to any products herein. ON Semiconductor makes no warranty, representation or guarantee regarding the suitability of its products for any particular purpose, nor does ON Semiconductor assume any liability arising out of the application or use of any product or circuit, and specifically disclaims any and all liability, including without limitation special, consequential or incidental damages. Buyer is responsible for its products and applications using ON Semiconductor products, including compliance with all laws, regulations and safety requirements or standards, regardless of any support or applications information provided by ON Semiconductor. "Typical" parameters which may be provided in ON Semiconductor data sheets and/or specifications can and do vary in different applications and actual performance may vary over time. All operating parameters, including "Typicals" must be validated for each customer application by customer's technical experts. ON Semiconductor does not convey any license under its patent rights nor the rights of others. ON Semiconductor products are not designed, intended, or authorized for use as a critical component in life support systems or any FDA Class 3 medical devices or medical devices with a same or similar classification in a foreign jurisdiction or any devices intended for implantation in the human body. Should Buyer purchase or use ON Semiconductor products for any such unintended or unauthorized application, Buyer shall indemnify and hold ON Semiconductor and its officers, employees, subsidiaries, affiliates, and distributors harmless against all claims, costs, damages, and expenses, and reasonable attorney fees arising out of, directly or indirectly, any claim of personal injury or death associated with such unintended or unauthorized use, even if such claim alleges that ON Semiconductor was negligent regarding the design or manufacture of the part. ON Semiconductor is an Equal Opportunity/Affirmative Action Employer. This literature is subject to all applicable copyright laws and is not for resale in any manner.

PUBLICATION ORDERING INFORMATION

LITERATURE FULFILLMENT:

Literature Distribution Center for ON Semiconductor
19521 E. 32nd Pkwy, Aurora, Colorado 80011 USA
Phone: 303-675-2175 or 800-344-3860 Toll Free USA/Canada
Fax: 303-675-2176 or 800-344-3867 Toll Free USA/Canada
Email: orderlit@onsemi.com

N. American Technical Support: 800-282-9855 Toll Free
USA/Canada
Europe, Middle East and Africa Technical Support:
Phone: 421 33 790 2910



ON Semiconductor Website: www.onsemi.com

Order Literature: <http://www.onsemi.com/orderlit>

For additional information, please contact your local
Sales Representative

Looking for pricing, stock, or lifecycle information?

Click below to explore more details on WIN SOURCE:

-  [View FOD817AW on WIN SOURCE](#)
-  [Fairchild/ON Semiconductor Information](#)

Optimize Your Supply Chain with WIN SOURCE Solutions

-  Global Sourcing Solution
-  Obsolete Management
-  Cost Control Management
-  Shortage Management
-  Alternative Solution
-  Excess Inventory Management