

# DATA SHEET

## ANTI-SULFURATED CHIP RESISTORS

AF series  
5%, 1%, 0.5%

sizes 0201/0402/0603/0805/1206/1210/1218/2010/2512

RoHS compliant & Halogen free



**SCOPE**

This specification describes AF0201 to AF2512 chip resistors with anti-sulfuration capabilities.

**APPLICATIONS**

- Industrial Equipment
- Power Application
- Networking Application
- High-end Computer & Multimedia Electronics in high sulfur environment
- Automotive electronics

**FEATURES**

- AEC-Q200 qualified
- Superior resistance against sulfur containing atmosphere
- Halogen free product and production
- RoHS compliant
- Reduces environmentally hazardous waste
- High component and equipment reliability
- Saving of PCB space
- Moisture sensitivity level: MSL 1

**ORDERING INFORMATION - GLOBAL PART NUMBER**

Part number is identified by the series name, size, tolerance, packaging type, temperature coefficient, taping reel and resistance value.

**GLOBAL PART NUMBER**

**AF XXXX X X X XX XXXX L**  
 (1) (2) (3) (4) (5) (6) (7)

**(1) SIZE**

0201/0402/0603/0805/1206/1210/1218/2010/2512

**(2) TOLERANCE**

- D = ±0.5%
- F = ±1%
- J = ±5% (for jumper ordering, use code of J)

**(3) PACKAGING TYPE**

- R = Paper taping reel
- K = Embossed plastic tape reel

**(4) TEMPERATURE COEFFICIENT OF RESISTANCE**

– = Base on spec

**(5) TAPING REEL**

- 07 = 7 inch dia. Reel
- 13 = 13 inch dia. Reel

**(6) RESISTANCE VALUE**

There are 2~4 digits indicated the resistance value. Letter R/K/M is decimal point. Detailed resistance rules are displayed in the table of "Resistance rule of global part number".

**(7) DEFAULT CODE**

Letter L is system default code for ordering only <sup>(Note)</sup>

| Resistance rule of global part number |                              |
|---------------------------------------|------------------------------|
| Resistance coding rule                | Example                      |
| XRX                                   | 1R = 1 Ω                     |
| (1 to 9.76 Ω)                         | 1R5 = 1.5 Ω<br>9R76 = 9.76 Ω |
| XXRX                                  | 10R = 10 Ω                   |
| (10 to 97.6 Ω)                        | 97R6 = 97.6 Ω                |
| XXXXR                                 | 100R = 100 Ω                 |
| (100 to 976 Ω)                        |                              |
| XKXX                                  | 1K = 1,000 Ω                 |
| (1 to 9.76 KΩ)                        | 9K76 = 9760 Ω                |
| XMXX                                  | 1M = 1,000,000 Ω             |
| (1 to 9.76 MΩ)                        | 9M76 = 9,760,000 Ω           |

**ORDERING EXAMPLE**

The ordering code for an AF0402 chip resistor, value 100 KΩ with ±1% tolerance, supplied in 7-inch tape reel with 10Kpcs quantity is: **AF0402FR-07100KL**.

**NOTE**

1. All our R-Chip products are RoHS compliant and Halogen free. "LFP" of the internal 2D reel label states "Lead-Free Process"
2. On customized label, "LFP" or specific symbol can be printed

**MARKING**

**AF0201 / AF0402**

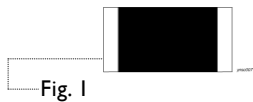

No marking

**AF0603 / AF0805 / AF1206 / AF1210 / AF2010 / AF2512**

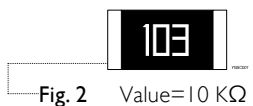

E-24 series: 3 digits,  $\pm 5\%$ ,  $\geq 10\Omega$   
First two digits for significant figure and 3rd digit for number of zeros

**AF0603**



E-24 series: 3 digits,  $\pm 1\%$   
One short bar under marking letter

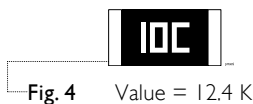

E-96 series: 3 digits,  $\pm 1\%$   
First two digits for E-96 marking rule and 3rd letter for number of zeros

**AF0805 / AF1206 / AF1210 / AF2010 / AF2512**

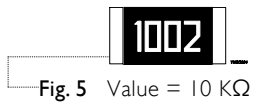

Both E-24 and E-96 series: 4 digits,  $\pm 1\%$   
First three digits for significant figure and 4th digit for number of zeros

**AF1218**

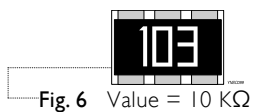

E-24 series: 3 digits,  $\pm 5\%$   
First two digits for significant figure and 3rd digit for number of zeros

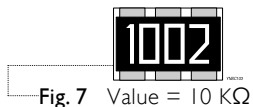

Both E-24 and E-96 series: 4 digits,  $\pm 1\%$   
First three digits for significant figure and 4th digit for number of zeros

**NOTE**

For further marking information, please see special data sheet "Chip resistors marking". Marking of AF series is the same as RC series

**CONSTRUCTION**

The resistors are constructed on top of a high grade ceramic body. Internal metal electrodes are added at each end and connected by a resistive glaze. The resistive glaze is covered by a glass.

The composition of the glaze is adjusted to give the approximate required resistance value and laser trimming of this resistive glaze achieves the value within tolerance.

The whole element is covered by a protective overcoat. Size 0603 and bigger is marked with the resistance value on top. Finally, the two external terminations (Ni / matte tin) are added. See fig.8

**DIMENSIONS**

Table I For outlines see fig. 8

| TYPE   | L (mm)    | W (mm)    | H (mm)    | I <sub>1</sub> (mm) | I <sub>2</sub> (mm) |
|--------|-----------|-----------|-----------|---------------------|---------------------|
| AF0201 | 0.60±0.03 | 0.30±0.03 | 0.23±0.03 | 0.12±0.05           | 0.15±0.05           |
| AF0402 | 1.00±0.05 | 0.50±0.05 | 0.32±0.05 | 0.20±0.10           | 0.25±0.10           |
| AF0603 | 1.60±0.10 | 0.80±0.10 | 0.45±0.10 | 0.25±0.15           | 0.25±0.15           |
| AF0805 | 2.00±0.10 | 1.25±0.10 | 0.50±0.10 | 0.35±0.20           | 0.35±0.20           |
| AF1206 | 3.10±0.10 | 1.60±0.10 | 0.55±0.10 | 0.45±0.20           | 0.40±0.20           |
| AF1210 | 3.10±0.10 | 2.60±0.15 | 0.55±0.10 | 0.45±0.15           | 0.50±0.20           |
| AF1218 | 3.10±0.10 | 4.60±0.10 | 0.55±0.10 | 0.45±0.20           | 0.40±0.20           |
| AF2010 | 5.00±0.10 | 2.50±0.15 | 0.55±0.10 | 0.55±0.15           | 0.50±0.20           |
| AF2512 | 6.35±0.10 | 3.10±0.15 | 0.55±0.10 | 0.60±0.20           | 0.50±0.20           |

**OUTLINES**

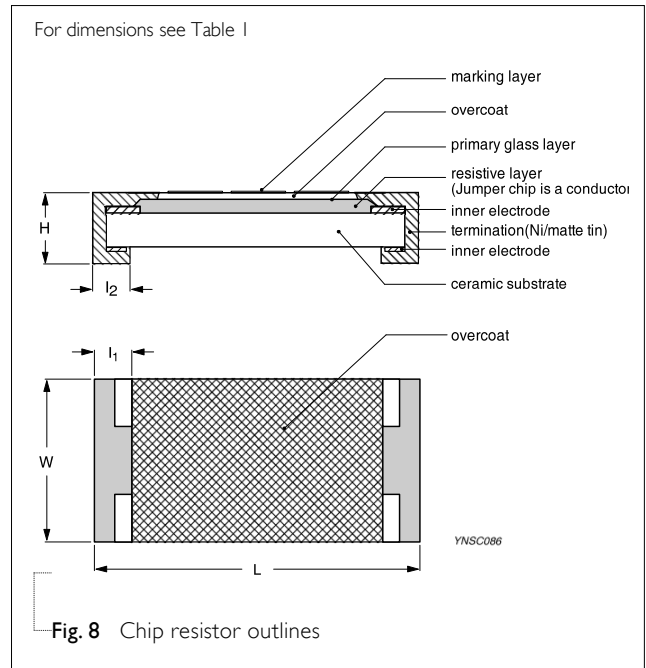

**ELECTRICAL CHARACTERISTICS**

Table 2

| TYPE   | RESISTANCE RANGE   | CHARACTERISTICS             |                      |                       |                                 |   |  |
|--------|--|-----------------------------|----------------------|-----------------------|---------------------------------|---|--|
|        |  | Operating Temperature Range | Max. Working Voltage | Max. Overload Voltage | Dielectric Withstanding Voltage | Temperature Coefficient of Resistance   | Jumper Criteria                                |
| AF0201 | ±5% (E24),<br>1Ω to 10MΩ   | -55 °C to +155 °C           | 25 V                 | 50 V                  | 50 V                            | 1Ω ≤ R ≤ 10Ω, -100/+350 ppm/°C<br>10Ω < R ≤ 10MΩ, ±200 ppm/°C                               | Rated Current<br>0.5A                          |
|        | ±0.5%, ±1% (E24/E96),<br>1Ω to 10MΩ<br>Zero Ohm Jumper < 0.05Ω   |                             |                      |                       |                                 |   | Max. Current<br>1.0A                           |
| AF0402 |  |                             | 50 V                 | 100 V                 | 100 V                           |   | Rated Current<br>1.0A                          |
| AF0603 |  |                             | 75 V                 | 150 V                 | 150 V                           |   | Max. Current<br>2.0A                           |
| AF0805 | ±5% (E24),<br>1Ω to 22 MΩ  | -55 °C to +155 °C           | 150 V                | 300 V                 | 300 V                           | 1Ω ≤ R ≤ 10Ω, ±200 ppm/°C<br>10Ω < R ≤ 10 MΩ, ±100 ppm/°C<br>10 MΩ < R ≤ 22 MΩ, ±200 ppm/°C | Rated Current<br>2.0A                          |
|        | ±0.5%, ±1% (E24/E96),<br>1Ω to 10 MΩ<br>Zero Ohm Jumper < 0.05 Ω |                             |                      |                       |                                 |   | Max. Current<br>5.0A                           |
| AF1206 |  |                             | 200 V                | 400 V                 | 500 V                           |   | Rated Current<br>2.0A<br>Max. Current<br>10.0A |
| AF1210 | ±5% (E24),<br>1Ω to 10MΩ   | -55 °C to +155 °C           | 200 V                | 500 V                 | 500 V                           |   | Rated Current<br>2.0A                          |
|        | ± 0.5%, ±1% (E24/E96),<br>1Ω to 10M<br>Zero Ohm Jumper < 0.05Ω   |                             |                      |                       |                                 |   | Max. Current<br>10.0A                          |
| AF1218 | ±5% (E24),<br>1Ω to 1MΩ  | -55 °C to +155 °C           | 200 V                | 500 V                 | 500 V                           | 1Ω ≤ R ≤ 10Ω, ±200 ppm/°C<br>10Ω < R ≤ 10MΩ, ±100 ppm/°C                                    | Rated Current<br>2.0A                          |
|        | ± 0.5%, ±1% (E24/E96),<br>1Ω to 1M<br>Zero Ohm Jumper < 0.05Ω    |                             |                      |                       |                                 |   | Max. Current<br>10.0A                          |
| AF2010 | ±5% (E24),<br>1Ω to 10MΩ   |                             | 200 V                | 500 V                 | 500 V                           |   | Rated Current<br>2.0A                          |
| AF2512 | ± 0.5%, ±1% (E24/E96),<br>1Ω to 10M<br>Zero Ohm Jumper < 0.05Ω   |                             | 200V                 | 500V                  | 500V                            |   | Max. Current<br>10.0A                          |

**FOOTPRINT AND SOLDERING PROFILES**

For recommended footprint and soldering profiles of AF-series is the same as RC-series. Please see the special data sheet “Chip resistors mounting”.

**PACKING STYLE AND PACKAGING QUANTITY**

Table 3 Packing style and packaging quantity

| PACKING STYLE            | REEL DIMENSION | AF0201        | AF0402        | AF0603/0805/1206 | AF1210 | AF1218/2010/2512 |
|--------------------------|----------------|---------------|---------------|------------------|--------|------------------|
| Paper taping reel (R)    | 7" (178 mm)    | 10,000/20,000 | 10,000/20,000 | 5,000            | 5,000  | --               |
|                          | 13" (330 mm)   | 50,000        | 50,000        | 20,000           | 20,000 | --               |
| Embossed taping reel (K) | 7" (178 mm)    | --            | --            | --               | --     | 4,000            |

**NOTE**

I. For paper/embossed tape and reel specification/dimensions, please see the special data sheet “Chip resistors packing”.

**FUNCTIONAL DESCRIPTION**

**OPERATING TEMPERATURE RANGE**

AF0201 - AF2512 Range:  
-55 °C to + 155 °C (Fig. 7)

**POWER RATING**

Each type rated power at 70 °C:

- AF0201=1/20W (0.05W)
- AF0402=1/16 W (0.0625W)
- AF0603=1/10 W (0.1W)
- AF0805=1/8 W (0.125W)
- AF1206=1/4 W (0.25W)
- AF1210=1/2W (0.5W)
- AF1218=1W
- AF2010=3/4W (0.75W)
- AF2512=1W

**RATED VOLTAGE**

The DC or AC (rms) continuous working voltage corresponding to the rated power is determined by the following formula:

$$V = \sqrt{(P \times R)}$$

Where

V = Continuous rated DC or AC (rms) working voltage (V)

P = Rated power (W)

R = Resistance value (Ω)

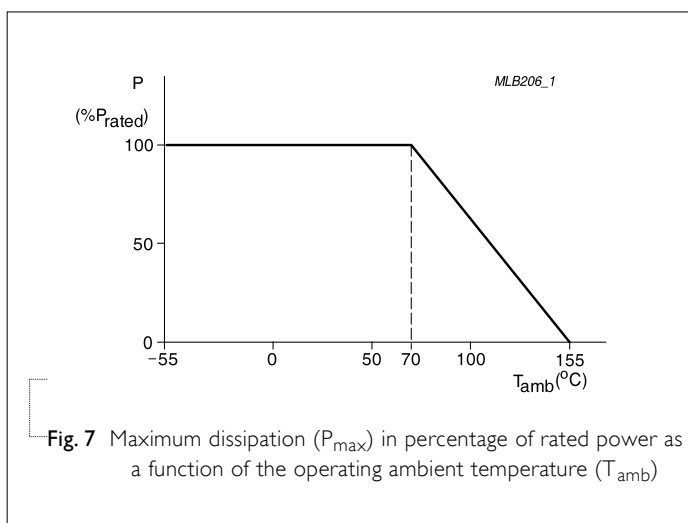

Fig. 7 Maximum dissipation (P<sub>max</sub>) in percentage of rated power as a function of the operating ambient temperature (T<sub>amb</sub>)

**TESTS AND REQUIREMENTS**

**Table 4** Test condition, procedure and requirements

| TEST   | TEST METHOD                                | PROCEDURE   | REQUIREMENTS   |
|--|--|---|--|
| Temperature Coefficient of Resistance (T.C.R.) | IEC 60115-1 4.8<br>MIL-STD-202 Method 304  | At +25/-55 °C and +25/+125 °C<br><br><b>Formula:</b><br>$T.C.R = \frac{R_2 - R_1}{R_1(t_2 - t_1)} \times 10^6 \text{ (ppm/°C)}$<br><br>Where<br>t <sub>1</sub> =+25 °C or specified room temperature<br>t <sub>2</sub> =-55 °C or +125 °C test temperature<br>R <sub>1</sub> =resistance at reference temperature in ohms<br>R <sub>2</sub> =resistance at test temperature in ohms | Refer to table 2   |
| Life/Endurance                                 | IEC 60115-1 4.25<br>MIL-STD-202 Method 108 | At 70±2 °C for 1,000 hours, RCWV applied for 1.5 hours on, 0.5 hour off, still-air required   | ±(1.0%+0.05 Ω)<br><100 mΩ for Jumper   |
| High Temperature Exposure                      | MIL-STD-202 Method 108                     | 1,000 hours at 155±3°C unpowered  | ±(1.0%+0.05 Ω)<br><100 mΩ for Jumper   |
| Moisture Resistance                            | MIL-STD-202 Method 106                     | Each temperature / humidity cycle is defined at 8 hours, 3 cycles / 24 hours for 10d. with 25 °C / 65 °C 95% R.H, without steps 7a & 7b, unpowered<br><br>Parts mounted on test-boards, without condensation on parts   | ±(0.5%+0.05 Ω) for 0.5%, 1% tol.<br>±(1.0%+0.05 Ω) for 5% tol.<br><100 mΩ for Jumper |
| Thermal Shock                                  | MIL-STD-202 Method 107                     | -55 / +125 °C<br><br>Number of cycles required is 300. Devices mounted<br><br>Maximum transfer time is 20 seconds. Dwell time is 15 minutes   | ±(0.5%+0.05 Ω) for 0.5%, 1% tol.<br>±(1%+0.05 Ω) for 5% tol.<br><100 mΩ for Jumper   |
| Short Time Overload                            | IEC60115-1 4.13                            | 2.5 times of rated voltage or maximum overload voltage whichever is less for 5 seconds at room temperature  | ±(1.0%+0.05 Ω)<br>No visible damage  |
| Bending  | IEC 60115-1 4.33                           | Chips mounted on a 90 mm glass epoxy resin PCB (FR4)<br><br>Bending: 0201/0402: 5 mm<br>0603/0805: 3 mm<br>1206 & above: 2 mm<br><br>Bending time: 60±5 seconds   | ±(1.0%+0.05 Ω)<br><100 mΩ for Jumper<br>No visible damage                            |

| TEST                           | TEST METHOD                                | PROCEDURE  | REQUIREMENTS   |
|--------------------------------|--|--|--|
| Biased Humidity                | MIL-STD-202 method 103                     | 1,000 hours; 85°C/85%R.H., 10% of operating power.<br>Measurement at 24±4 hours after test conclusion.   | $1\Omega \leq R \leq 1M\Omega: \pm(3\%+0.05\Omega)$<br>$1M\Omega < R \leq 10M\Omega: \pm(5\%+0.05\Omega)$                  |
| <b>Solderability</b>           |  |  |  |
| - Resistance to Soldering Heat | IEC 60115-1 4.18<br>MIL-STD-202 Method 215 | Condition B, no pre-heat of samples<br>Lead-free solder, 260±5 °C, 10±1 seconds immersion time<br>Procedure 2 for SMD: devices fluxed and cleaned with isopropanol                                       | $\pm(0.5\%+0.05\Omega)$ for 0.5%, 1% tol.<br>$\pm(1.0\%+0.05\Omega)$ for 5% tol.<br><50 mΩ for Jumper<br>No visible damage |
| - Wetting                      | J-STD-002                                  | Electrical test not required<br>Magnification 10X<br>SMD conditions:<br>(a) Method B, aging 4 hours at 155 °C dry heat, lead-free solder bath at 245 °C<br>(b) Method B, dipping at 215 °C for 3 seconds | Well tinned (≥95% covered)<br>No visible damage  |
| FOS                            | ASTM-B-809-95*<br>* Modified               | Sulfur 750 hours, 105 °C. unpowered  | $\pm(4.0\%+0.05\Omega)$  |



REVISION HISTORY

| REVISION  | DATE          | CHANGE NOTIFICATION | DESCRIPTION  |
|-----------|---------------|---------------------|--|
| Version 5 | Jun. 21, 2016 | -                   | - Update test and requirement                              |
| Version 4 | Dec. 24, 2015 | -                   | - Update Dielectric Withstanding Voltage& Resistance value |
| Version 3 | Apr. 01, 2015 | -                   | - Modified test and requirements                           |
| Version 2 | Nov. 20, 2014 | -                   | - Tests and requirement update                             |
| Version 1 | Sep. 27, 2013 | -                   | - Size 0201/1210/1218/2010/2512 extend                     |
| Version 0 | Jan 07, 2011  | -                   | - First issue of this specification                        |

*“Yageo reserves all the rights for revising the content of this datasheet without further notification, as long as the products are unchanged. Any product change will be announced by PCN.”*

## Looking for pricing, stock, or lifecycle information?

Click below to explore more details on WIN SOURCE:

-  [View AF0402JR-078K2L on WIN SOURCE](#)
-  [Yageo Information](#)

## Optimize Your Supply Chain with WIN SOURCE Solutions

-  Global Sourcing Solution
-  Obsolete Management
-  Cost Control Management
-  Shortage Management
-  Alternative Solution
-  Excess Inventory Management