



**THE DATASHEET OF
B130LB-13**



Features

- Schottky Barrier Chip
- Guard Ring Die Construction for Transient Protection
- Ideally Suited for Automatic Assembly
- Low Power Loss, High Efficiency
- Surge Overload Rating to 40A Peak
- For Use in Low Voltage, High Frequency Inverters, Free Wheeling, and Polarity Protection Application
- High Temperature Soldering: 260°C/10 Second at Terminal

Mechanical Data

- Case: SMB, Molded Plastic
- Plastic Material: UL Flammability Classification Rating 94V-0
- Moisture sensitivity: Level 1 per J-STD-020A
- Terminals: Solder Plated Terminal - Solderable per MIL-STD-202, Method 208
- Also Available in Lead Free Plating (Matte Tin Finish). Please See Ordering Information, Note 4, on Page 3
- Polarity: Cathode Band or Cathode Notch
- Weight: 0.093 grams (approx.)
- Marking: B13LB

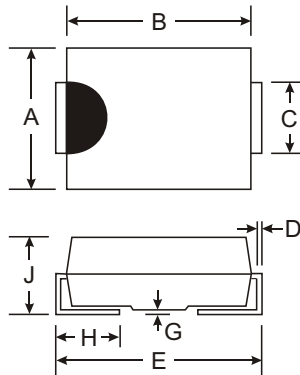

SMB		
Dim	Min	Max
A	3.30	3.94
B	4.06	4.57
C	1.96	2.21
D	0.15	0.31
E	5.00	5.59
G	0.10	0.20
H	0.76	1.27
J	2.00	2.62
All Dimensions in mm		

Maximum Ratings and Electrical Characteristics @ T_A = 25°C unless otherwise specified

Single phase, half wave, 60Hz, resistive or inductive load.
For capacitive load, derate current by 20%.

Characteristic	Symbol	B130LB	Unit
Peak Repetitive Reverse Voltage Working Peak Reverse Voltage DC Blocking Voltage	V _{RRM} V _{RWM} V _R	30	V
RMS Reverse Voltage	V _{R(RMS)}	21	V
Average Rectified Output Current @ T _T = 120°C @ T _T = 110°C	I _O	1.0 2.0	A
Non-Repetitive Peak Forward Surge Current 8.3ms Single half sine-wave Superimposed on Rated Load (JEDEC Method)	I _{FSM}	40	A
Forward Voltage @ I _F = 1.0A @ I _F = 2.0A	V _{FM}	0.395 0.445	V
Peak Reverse Current at Rated DC Blocking Voltage @ T _A = 25°C @ T _A = 100°C	I _{RM}	1.0 20	mA
Typical Total Capacitance (Note 1)	C _T	90	pF
Typical Thermal Resistance Junction to Terminal	R _{θJT}	12	°C/W
Operating and Storage Temperature Range	T _J , T _{STG}	-55 to +125	°C

Notes: 1. Measured at 1.0MHz and applied reverse voltage of 4.0V DC.

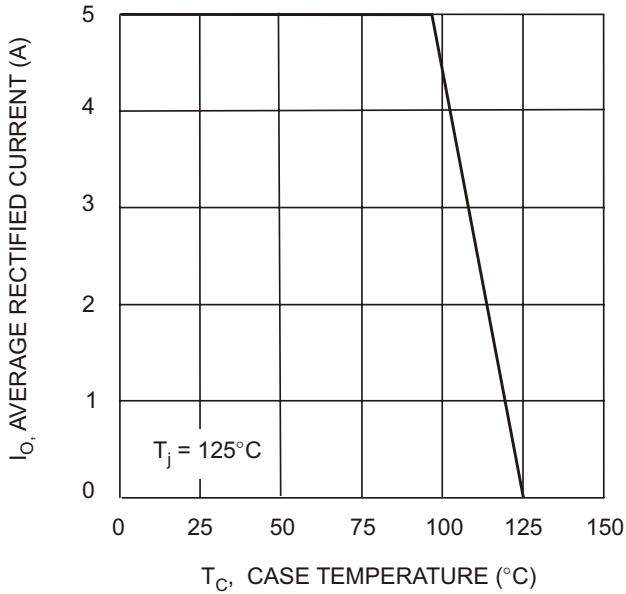

Fig. 1 Forward Current Derating Curve

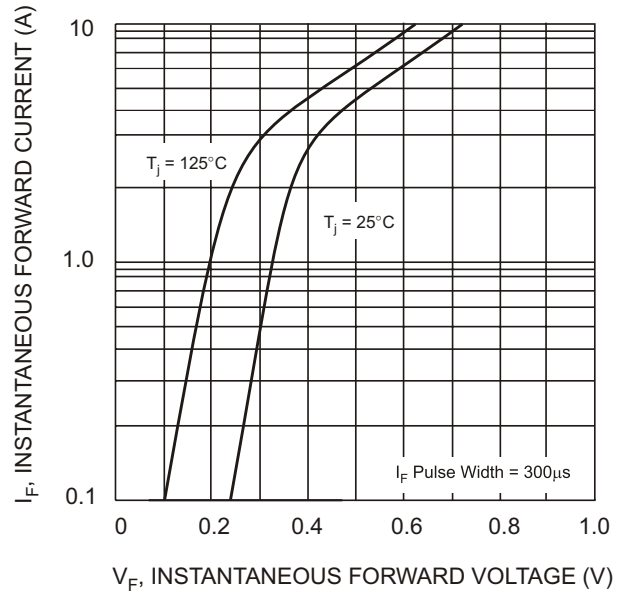

Fig. 2 Typical Forward Characteristics

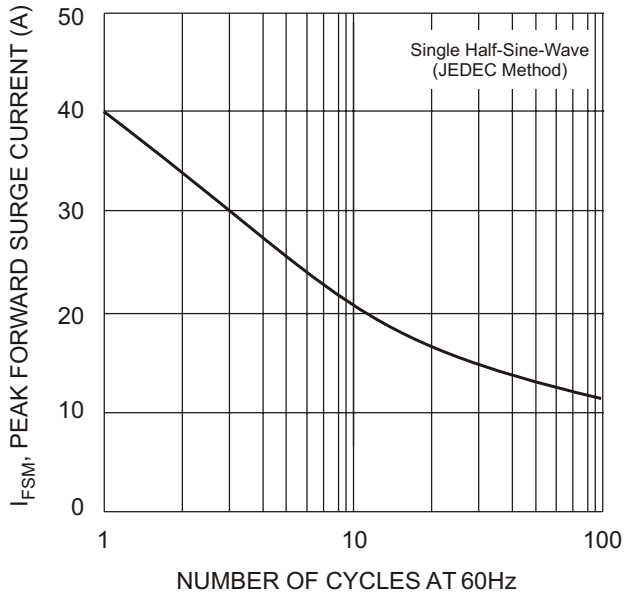

Fig. 3 Max Non-Repetitive Peak Forward Surge Current

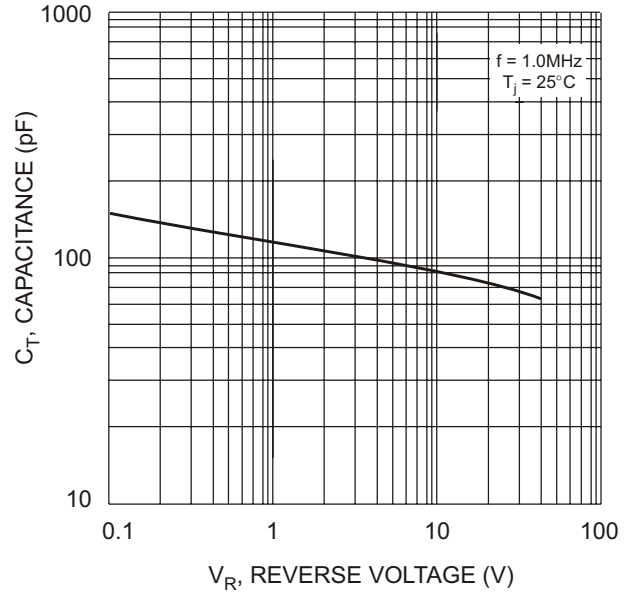

Fig. 4 Typical Total Capacitance

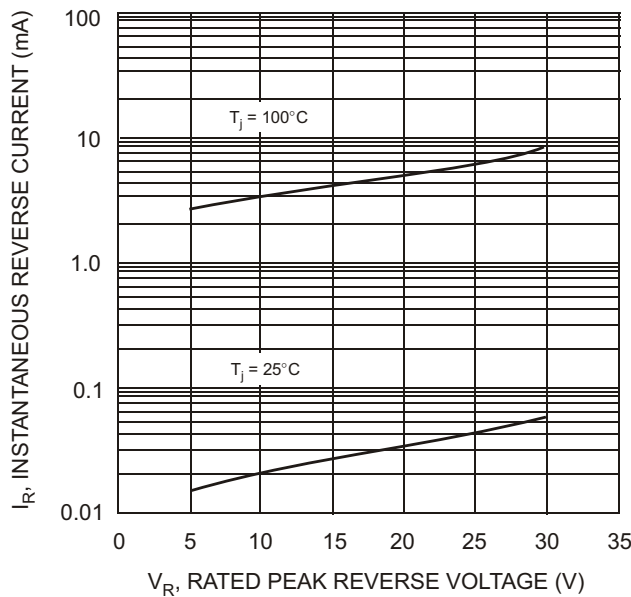
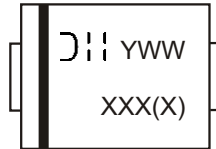

Fig. 5 Typical Reverse Characteristics

Ordering Information (Note 3 & 4)

Device	Packaging	Shipping
B130LB-13	SMB	3000/Tape & Reel



- Notes:
- For Packaging Details, go to our website at <http://www.diodes.com/datasheets/ap02007.pdf>.
 - For lead free terminal plating part number, please add "-F" suffix to part number above. Example: B130LB-13-F.



XXXX = Product type marking code, ex: B130LB (SMB package)
 $\text{D} \parallel$ = Manufacturers' code marking
YWW = Date code marking
Y = Last digit of year ex: 2 for 2002
WW = Week code 01 to 52
Band = Cathode

Looking for pricing, stock, or lifecycle information?

Click below to explore more details on WIN SOURCE:

-  [View B130LB-13 on WIN SOURCE](#)
-  [Diodes Incorporated Information](#)

Optimize Your Supply Chain with WIN SOURCE Solutions

-  Global Sourcing Solution
-  Obsolete Management
-  Cost Control Management
-  Shortage Management
-  Alternative Solution
-  Excess Inventory Management