



**THE DATASHEET OF
AH1751-PG-B-A**



Description

AH1751 is a single-digital-output Hall-effect sensor for high temperature operation. The device includes an on-chip Hall voltage generator for magnetic sensing, an amplifier to amplify Hall voltage, and a comparator to provide switching hysteresis for noise rejection, and an open-collector output pre-driver. An internal band-gap regulator is used to provide temperature compensated supply voltage for internal circuits and allows a wide operating supply range.

While the magnetic flux density (B) is larger than threshold B_{op} , the OUT pin turns on (low). If B removed toward B_{rp} , the OUT pin is latched "on" state prior to $B < B_{rp}$. When $B < B_{rp}$, the OUT pin go into "off" state.

Features

- Bipolar Hall Effect Latch Sensor
- 3.5V to 20V DC Operation Voltage
- Open Collector Pre-Driver
- 50mA Output Sink Current
- Chip Power Reverse-Connection Protection
- Operating Temperature: -40°C to 125°C
- SIP3, SC59 and SC59R (Commonly known as SOT23 in Asia): Available in "Green" Molding Compound (No Br, Sb)
- **Totally Lead-free & Fully RoHS Compliant (Note 1 & 2)**
- **Halogen and Antimony Free. "Green" Device (Note 3)**

Pin Assignments

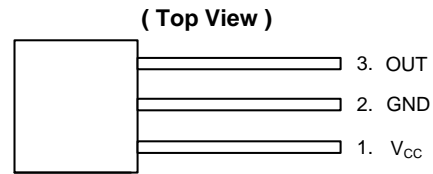

SIP3

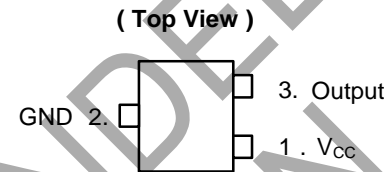

SC59

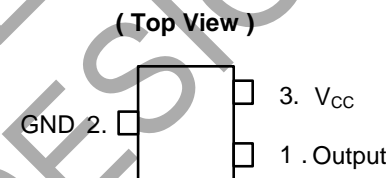

SC59R

Applications

- Rotor Position Sensing
- Current Switch
- Encoder
- RPM Detection

Notes:

1. No purposely added lead. Fully EU Directive 2002/95/EC (RoHS), 2011/65/EU (RoHS 2) & 2015/863/EU (RoHS 3).compliant.
2. See <https://www.diodes.com/quality/lead-free/> for more information about Diodes Incorporated's definitions of Halogen- and Antimony-free, "Green" and Lead-free.
3. Halogen- and Antimony-free "Green" products are defined as those which contain <900ppm bromine, <900ppm chlorine (<1500ppm total Br + Cl) and <1000ppm antimony compounds.

Pin Descriptions

Pin Name	Description
V _{CC}	Input Power
GND	Ground
OUT	Output Stage

Functional Block Diagram

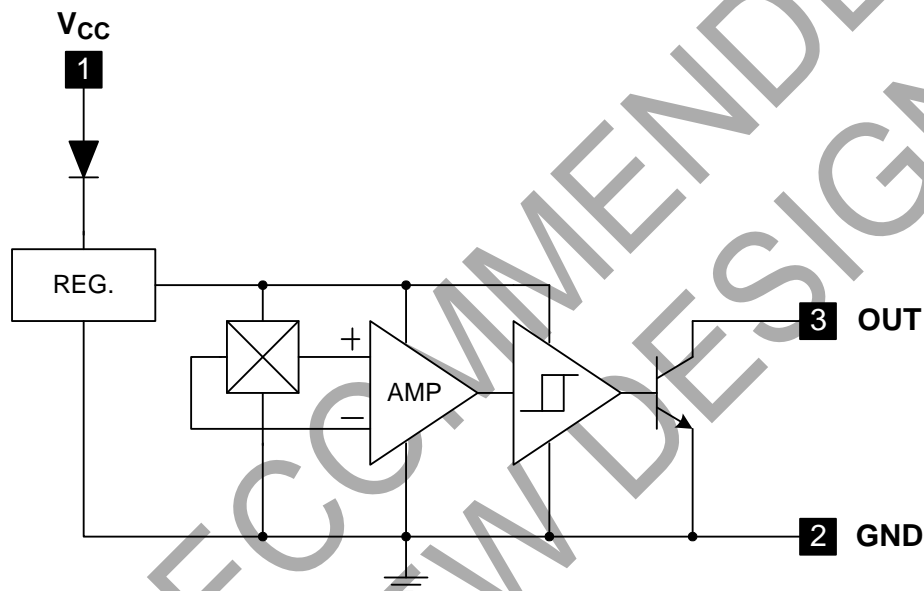

Absolute Maximum Ratings (@T_A = +25°C, unless otherwise specified.)

Symbol	Parameter	Rating	Unit	
V _{CC}	Supply Voltage	20	V	
V _{OUT (off)}	Output "OFF" Voltage	20	V	
I _{O (sink)}	Output "ON" Current	100	mA	
T _{ST}	Storage Temperature Range	-65 to +150	°C	
T _{J(MAX)}	Maximum Junction Temperature	+150	°C	
P _D	Power Dissipation	SIP3	550	mW
		SC59 and SC59R	230	mW

Recommended Operating Conditions

Symbol	Parameter	Conditions	Min	Max	Unit
V_{CC}	Supply Voltage	Operating (Note 4)	3.5	20	V
T_A	Operating Temperature Range	Operating	-40	+125	°C

Note: 4. Operating, the output is switching as magnetic field change (S>300G, N<-300G).

Electrical Characteristics (@ $T_A = +25^\circ\text{C}$, unless otherwise specified.)

Symbol	Parameter	Conditions	Min	Typ	Max	Unit
$V_{OUT(SAT)}$	Output Saturation Voltage	$V_{CC} = 12\text{V}$, OUT "ON" $I_O = 50\text{mA}$	-	200	300	mV
I_{CC}	Supply Current	$V_{CC} = 12\text{V}$, OUT "OFF"	-	3.5	6	mA

Magnetic Characteristics (@ $T_A = +25^\circ\text{C}$, $V_{CC} = 4\text{V}$ to 20V , unless otherwise specified. Note 5)

A grade

(1mT = 10 Gauss)

Symbol	Parameter	Min	Typ.	Max	Unit
B_{ops} (south pole to brand side)	Operation Point	5	-	70	Gauss
B_{rps} (south pole to brand side)	Release Point	-70	-	-5	Gauss
B_{hy} ($ B_{opx} - B_{rpx} $)	Hysteresis	-	75	-	Gauss

Notes: 5. Magnetic characteristics are for design information, which will vary with supply voltage, operating temperature and after soldering.

Operating Characteristics

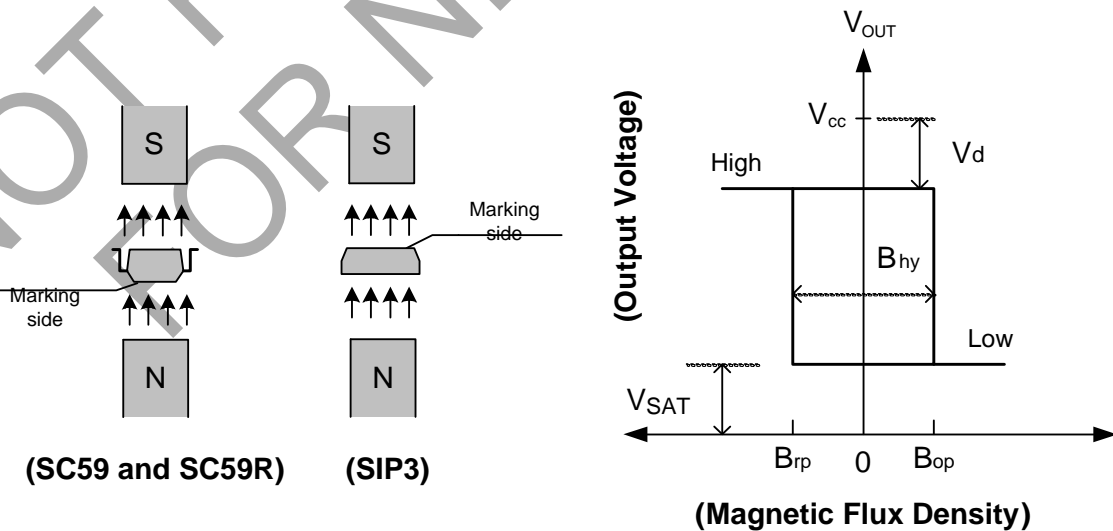

Performance Characteristics

(1) SIP3

T_A (°C)	25	50	60	70	80	85	90	95	100
P_D (mW)	550	440	396	352	308	286	264	242	220
T_A (°C)	105	110	115	120	125	130	135	140	150
P_D (mW)	198	176	154	132	110	88	66	44	0

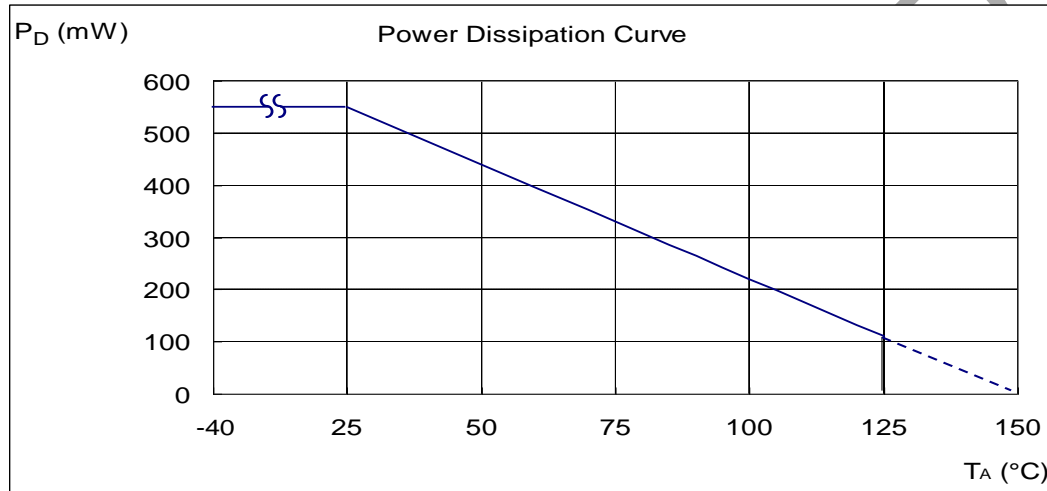

(2) SC59 and SC59R (Commonly known as SOT23 in Asia)

T_A (°C)	25	50	60	70	80	90	100	110	120	125	130	140	150
P_D (mW)	230	184	166	147	129	110	92	74	55	46	37	18	0

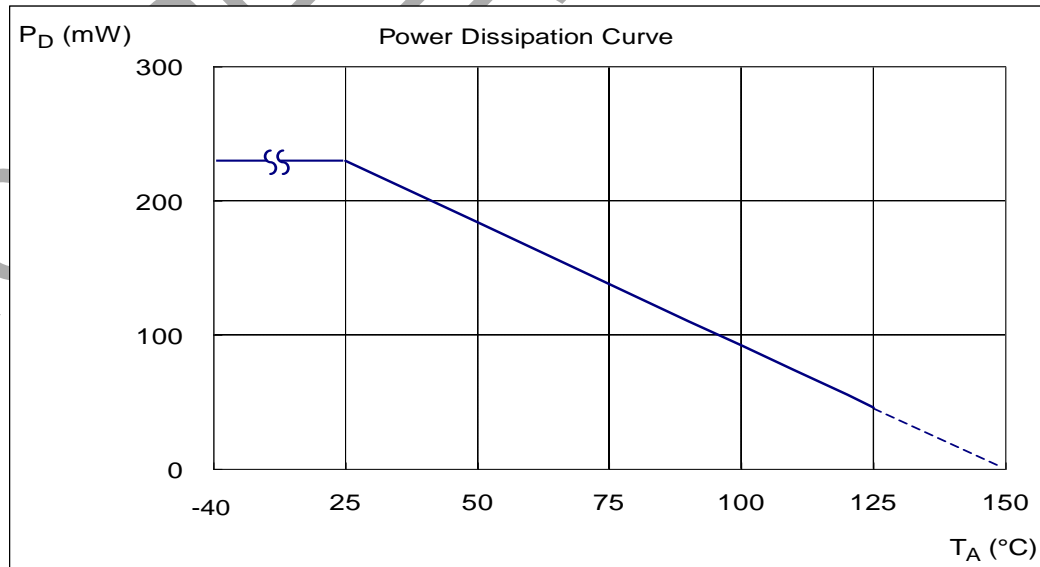

Ordering Information

AH1751 -X X - X

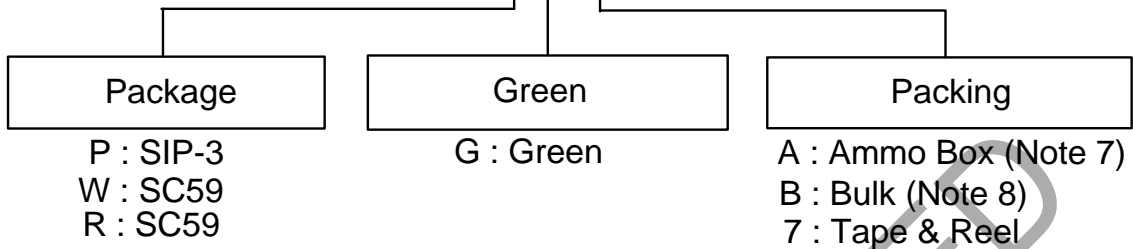

Part Number	Status (Note 9)	Package Code	Packaging (Note 6)	Bulk		7" Tape and Reel		Ammo Box	
				Quantity	Part Number Suffix	Quantity	Part Number Suffix	Quantity	Part Number Suffix
AH1751-PG-A-A	NRND	P	SIP-3	NA	NA	NA	NA	4000/Box	A
AH1751-PG-B-A	NRND	P	SIP-3	1000	-B	NA	NA	NA	NA
AH1751-WG-7-A	NRND	W	SC59	NA	NA	3000/Tape & Reel	-7	NA	NA
AH1751-RG-7-A	NRND	W	SC59R	NA	NA	3000/Tape & Reel	-7	NA	NA

Notes: 6. Pad layout as shown on Diodes Inc. suggested pad layout document, which can be found on our website at <http://www.diodes.com/package-outlines.html>.
 7. Ammo Box is for SIP3 Spread Lead.
 8 . Bulk is for SIP-3 Straight Lead.
 9: NRND = Not Recommended for New Design

Marking Information

(1) Package Type: SIP-3 (Ammo Pack), SIP-3 (Bulk Pack)

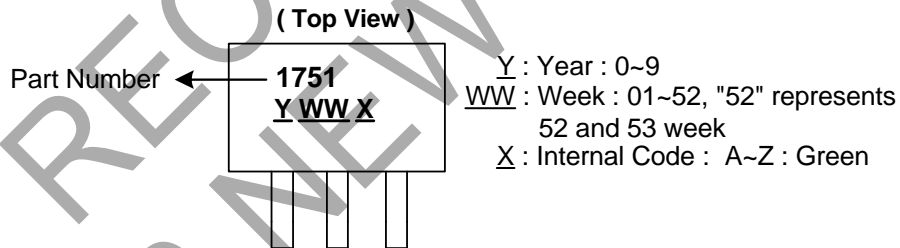

(2) Package Type: SC59 and SC59R (Commonly known as SOT23 in Asia)

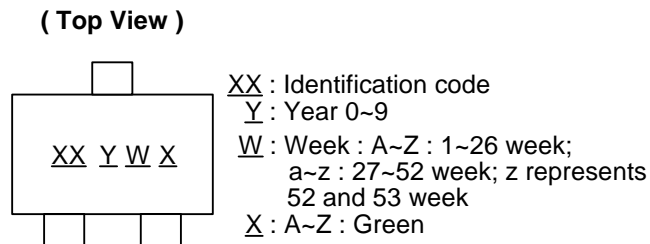

Part Number	Package	Identification Code
AH1751	SC59	RK
AH1751	SC59R	SK

Package Outline Dimensions and Suggested Pad Layout (All dimensions in mm.)

Please see <http://www.diodes.com/package-outlines.html> for the latest version.

(1) Package Type: SIP3 for Bulk pack

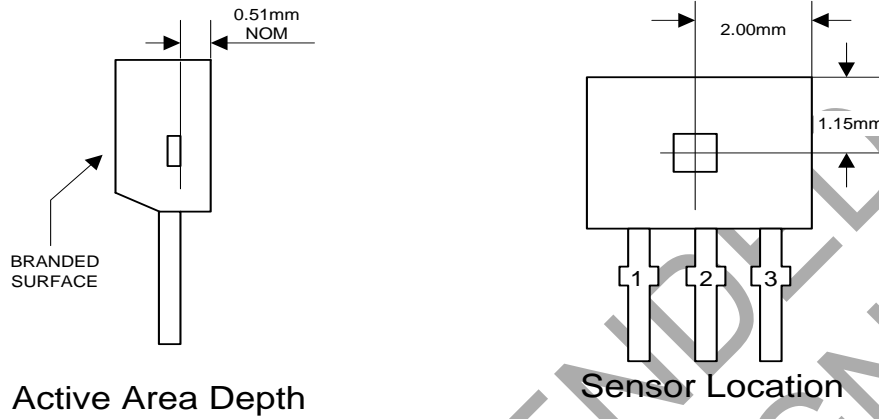

Package Dimension

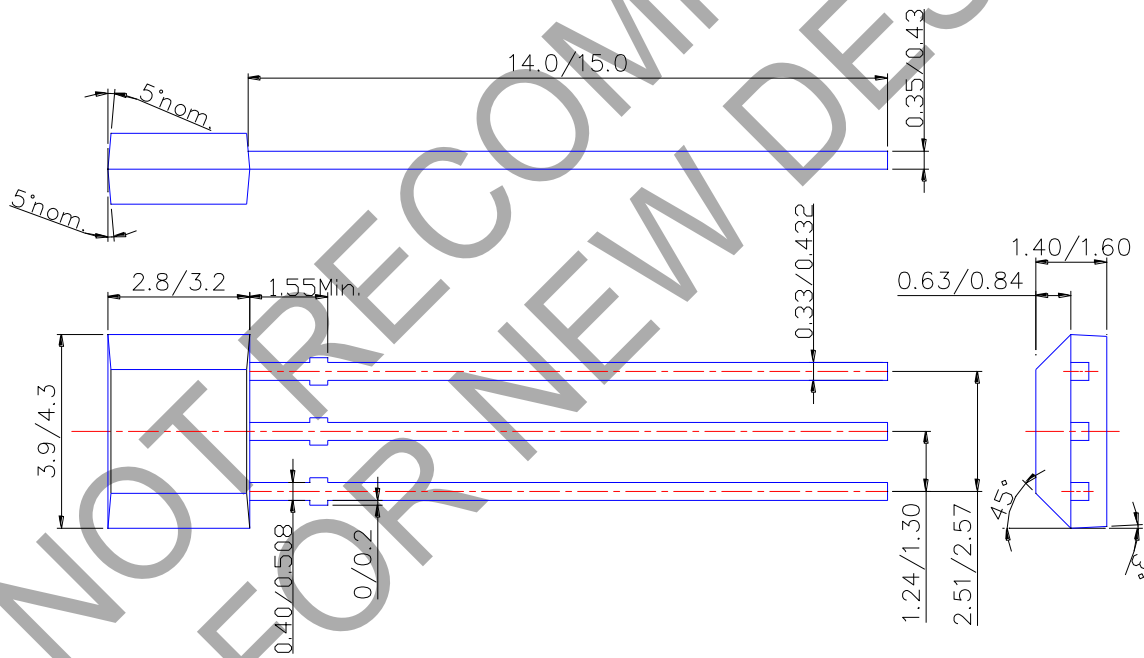

Package Outline Dimensions and Suggested Pad Layout (All dimensions in mm. Cont.)

Please see <http://www.diodes.com/package-outlines.html> for the latest version.

(2) Package Type: SIP3 for Ammo Pack

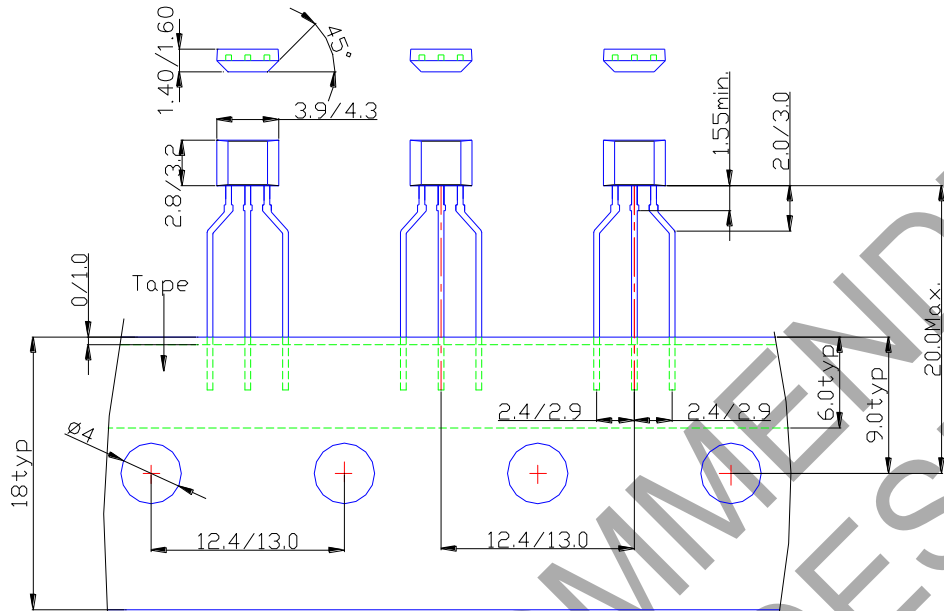

(3) Package Type: SC59 and SC59R (Commonly known as SOT23 in Asia)

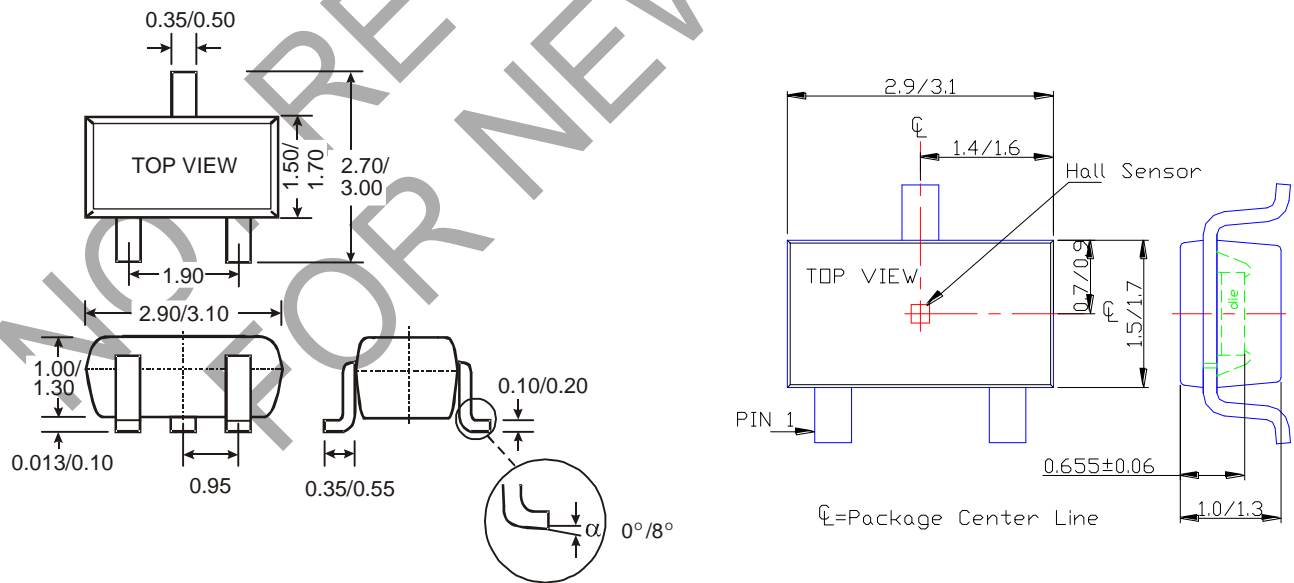

IMPORTANT NOTICE

DIODES INCORPORATED MAKES NO WARRANTY OF ANY KIND, EXPRESS OR IMPLIED, WITH REGARDS TO THIS DOCUMENT, INCLUDING, BUT NOT LIMITED TO, THE IMPLIED WARRANTIES OF MERCHANTABILITY AND FITNESS FOR A PARTICULAR PURPOSE (AND THEIR EQUIVALENTS UNDER THE LAWS OF ANY JURISDICTION).

Diodes Incorporated and its subsidiaries reserve the right to make modifications, enhancements, improvements, corrections or other changes without further notice to this document and any product described herein. Diodes Incorporated does not assume any liability arising out of the application or use of this document or any product described herein; neither does Diodes Incorporated convey any license under its patent or trademark rights, nor the rights of others. Any Customer or user of this document or products described herein in such applications shall assume all risks of such use and will agree to hold Diodes Incorporated and all the companies whose products are represented on Diodes Incorporated website, harmless against all damages.

Diodes Incorporated does not warrant or accept any liability whatsoever in respect of any products purchased through unauthorized sales channel. Should Customers purchase or use Diodes Incorporated products for any unintended or unauthorized application, Customers shall indemnify and hold Diodes Incorporated and its representatives harmless against all claims, damages, expenses, and attorney fees arising out of, directly or indirectly, any claim of personal injury or death associated with such unintended or unauthorized application.

Products described herein may be covered by one or more United States, international or foreign patents pending. Product names and markings noted herein may also be covered by one or more United States, international or foreign trademarks.

This document is written in English but may be translated into multiple languages for reference. Only the English version of this document is the final and determinative format released by Diodes Incorporated.

LIFE SUPPORT

Diodes Incorporated products are specifically not authorized for use as critical components in life support devices or systems without the express written approval of the Chief Executive Officer of Diodes Incorporated. As used herein:

A. Life support devices or systems are devices or systems which:

1. are intended to implant into the body, or
2. support or sustain life and whose failure to perform when properly used in accordance with instructions for use provided in the labeling can be reasonably expected to result in significant injury to the user.

B. A critical component is any component in a life support device or system whose failure to perform can be reasonably expected to cause the failure of the life support device or to affect its safety or effectiveness.

Customers represent that they have all necessary expertise in the safety and regulatory ramifications of their life support devices or systems, and acknowledge and agree that they are solely responsible for all legal, regulatory and safety-related requirements concerning their products and any use of Diodes Incorporated products in such safety-critical, life support devices or systems, notwithstanding any devices- or systems-related information or support that may be provided by Diodes Incorporated. Further, Customers must fully indemnify Diodes Incorporated and its representatives against any damages arising out of the use of Diodes Incorporated products in such safety-critical, life support devices or systems.

Copyright © 2018, Diodes Incorporated

www.diodes.com

Looking for pricing, stock, or lifecycle information?

Click below to explore more details on WIN SOURCE:

 [View AH1751-PG-B-A on WIN SOURCE](#)

 [Diodes Incorporated](#) Information

Optimize Your Supply Chain with WIN SOURCE Solutions

-  Global Sourcing Solution
-  Obsolete Management
-  Cost Control Management
-  Shortage Management
-  Alternative Solution
-  Excess Inventory Management