

Features

- Micropower operation
- 2.5V to 5.5V battery operation
- Offset Canceling Technology
- Superior temperature stability
- Extremely Low Switch-Point Drift
- Insensitive to Physical Stress
- -40°C to 85°C operating temperature
- Lead Free packages: SIP-3L and SC59 (Commonly known as SOT23 in Asia)
- SIP-3L and SC59: Available in "Green" Molding Compound (No Br, Sb)
- Lead Free Finish / RoHS Compliant (Note 1)

General Description

AH182/AH183 is a three-terminal Hall effect sensor device with an output driver, mainly designed for battery-operation, hand-held equipment (such as cellular and cordless phones, and PDA's) The total operation power is down to 15uW in the 2.75V supply.

The south pole of sufficient strength will turn the output on in SIP-3L but the north pole of sufficient strength will turn the output on in SC59 package. The output will be turned off under no magnetic field.

While the magnetic flux density (**B**) is larger than operation point (**Bop**), the output will be turned on (low), the output is held until **B** is lower than the release point (**Brp**), then turned off. The difference between AH182 and AH183 is that the former consumes less power than that of the latter in the Hall sensor operation.

Applications

- Cover detector
- Speed measurement
- Home safety

Typical Circuit *

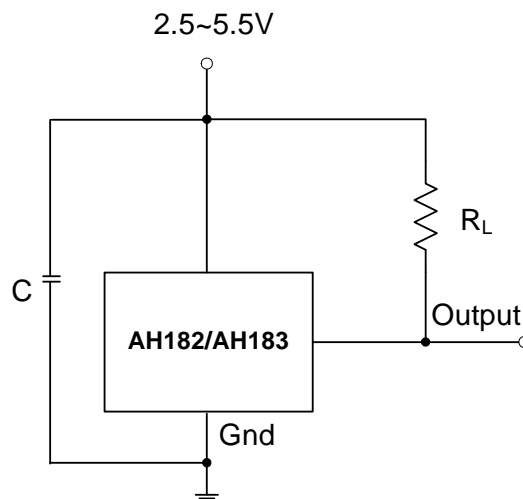

* C is for power stabilization and to strengthen the noise immunity, the recommended capacitance is 10nF~100nF.

RL is the pull-up resistor, the recommended resistance is 10Kohm~100Kohm.

Ordering Information

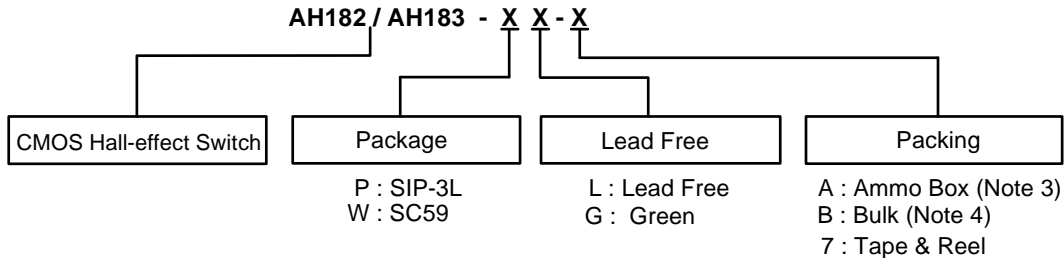

Device	Package Code	Packaging (Note 2)	Bulk		7" Tape and Reel		Ammo Box	
			Quantity	Part Number Suffix	Quantity	Part Number Suffix	Quantity	Part Number Suffix
AH182/AH183-PL-A	P	SIP-3L	NA	NA	NA	NA	4000/Box	-A
AH182/AH183-PL-B	P	SIP-3L	1000	-B	NA	NA	NA	NA
AH182/AH183-PG-A	P	SIP-3L	NA	NA	NA	NA	4000/Box	-A
AH182/AH183-PG-B	P	SIP-3L	1000	-B	NA	NA	NA	NA
AH182/AH183-WL-7	W	SC59	NA	NA	3000/Tape & Reel	-7	NA	NA
AH182/AH183-WG-7	W	SC59	NA	NA	3000/Tape & Reel	-7	NA	NA

- Notes:
1. EU Directive 2002/95/EC (RoHS). All applicable RoHS exemptions applied. Please visit our website at http://www.diodes.com/products/lead_free.html
 2. Pad layout as shown on Diodes Inc. suggested pad layout document AP02001, which can be found on our website at <http://www.diodes.com/datasheets/ap02001.pdf>.
 3. Ammo Box is for SIP-3L Spread Lead.
 4. Bulk is for SIP-3L Straight Lead.

Pin Assignments

(1) SIP-3L

(Top view)

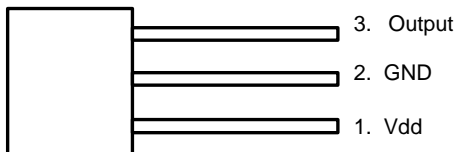

(2) SC59 (Commonly known as SOT23 in Asia)

(Top view)

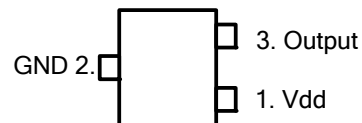

Pin Description

Pin Name	P/I/O	Pin #	Description
Vdd	P/I	1	Power Supply Input
GND	P	2	Ground
Output	O	3	Output Pin

Block Diagram

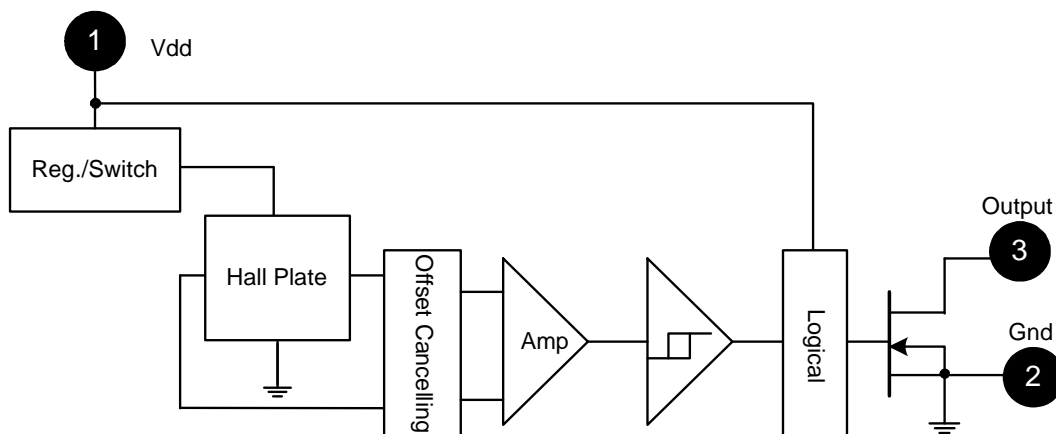

Absolute Maximum Ratings ($T_A = 25^\circ\text{C}$)

Symbol	Parameter	Rating	Unit
Vdd	Supply Voltage	7	V
B	Magnetic Flux Density	Unlimited	
I _{OUT}	Output current	10	mA
P _D	Power Dissipation	SIP-3L	550
		SC59	230
T _{J(MAX)}	Maximum Junction Temperature	150	°C
T _{ST}	Storage Temperature Range	-65 to +150	°C

Recommended Operating Conditions ($T_A = 25^\circ\text{C}$)

Symbol	Parameter	Conditions	Min	Max	Unit
Vdd	Supply Voltage	Operating	2.5	5.5	V
T _A	Operating Ambient Temperature	Operating	-40	85	°C

Electrical Characteristics ($T_A = 25^\circ\text{C}$, $V_{dd} = 3\text{V}$)

Symbol	Characteristic	Conditions	Min	Typ.	Max	Unit
V_{OUT}	Output On Voltage	$I_{OUT} = 1\text{mA}$	-	0.1	0.3	V
I_{off}	Output Leakage Current	$V_{OUT} = 5.5\text{V}$, $B < Brp$	-	<0.1	1	μA
$I_{dd(en)}$	Supply Current	Chip enable	-	-	2.0	mA
$I_{dd(dis)}$		Chip disable	-	-	8.0	μA
$I_{dd(ave)}$		AH182: average supply current	-	5	10	μA
$I_{dd(ave)}$		AH183: average supply current	-	280	500	μA
T_{awake}	Awake Time		-	50	100	μs
T_{period}	Period	AH182	-	50	100	ms
		AH183	-	200	400	μs
D.C.	Duty Cycle	AH182	-	0.1	-	%
		AH183	-	25	-	%

Test Circuit

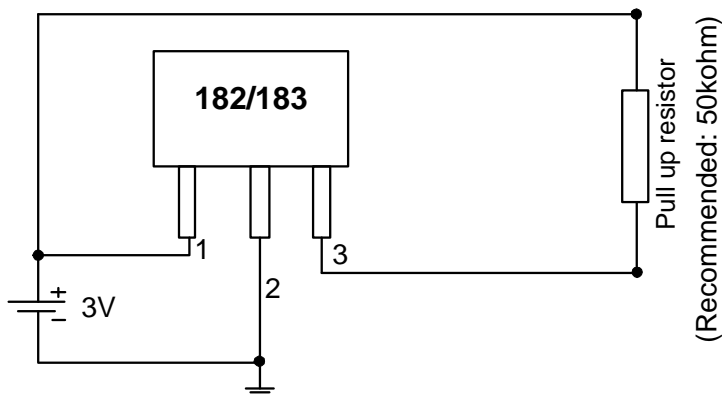

Magnetic Characteristics ($T_A = 25^\circ\text{C}$, $V_{dd} = 3\text{V}$, Note 5)

(1mT = 10 Gauss)

Symbol	Parameter	Min	Typ.	Max	Unit
Bops(south pole to brand side)	Operation Point	-	40	60	Gauss
Brps(south pole to brand side)	Release Point	10	30	-	
Bhy($ B_{opx} - B_{rpx} $)	Hysteresis	-	10	-	

Notes: 5. Magnetic characteristics are for design information, which will vary with supply voltage, operating temperature and after soldering.

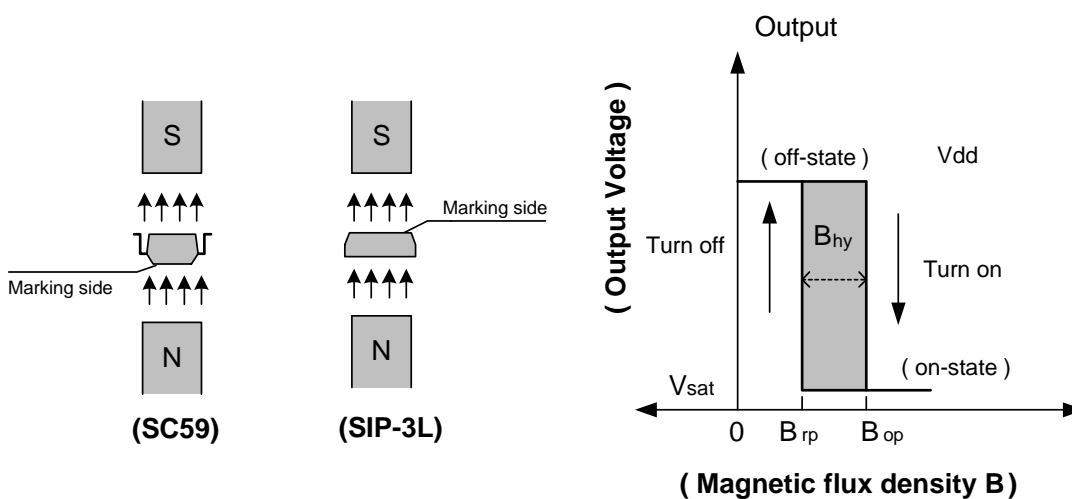

Performance Characteristics

(1) SIP-3L

TA (°C)	25	50	60	70	80	85	90	95	100
PD (mW)	550	440	396	352	308	286	264	242	220
TA (°C)	105	110	115	120	125	130	135	140	150
PD (mW)	198	176	154	132	110	88	66	44	0

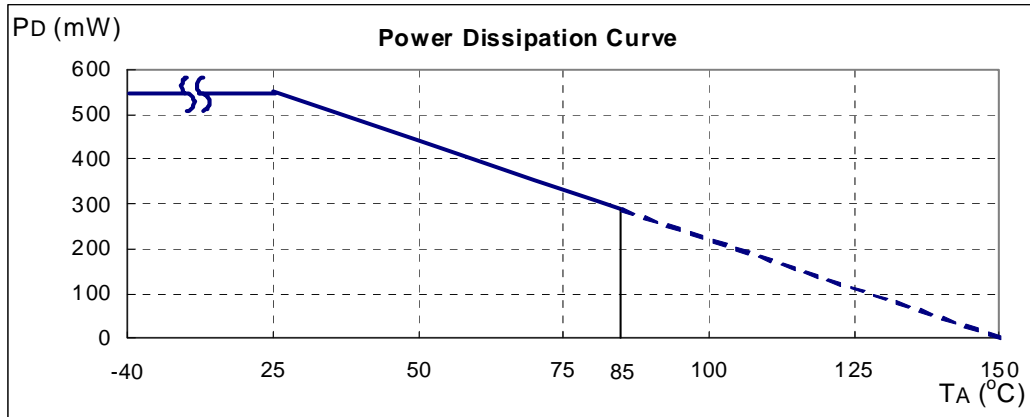

(2) SC59 (Commonly known as SOT23 in Asia)

TA (°C)	25	50	60	70	80	85	90	100	110	120	130	140	150
PD (mW)	230	184	166	147	129	120	110	92	74	55	37	18	0

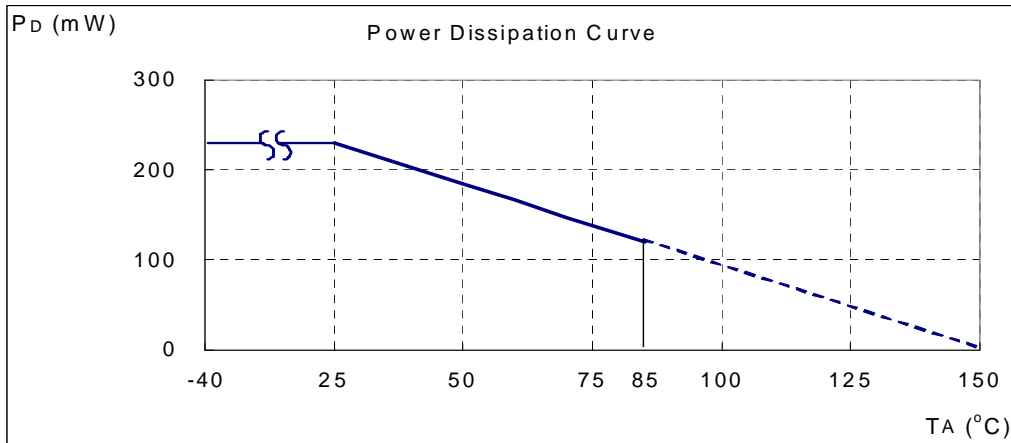

Marking Information

(1) SIP-3L

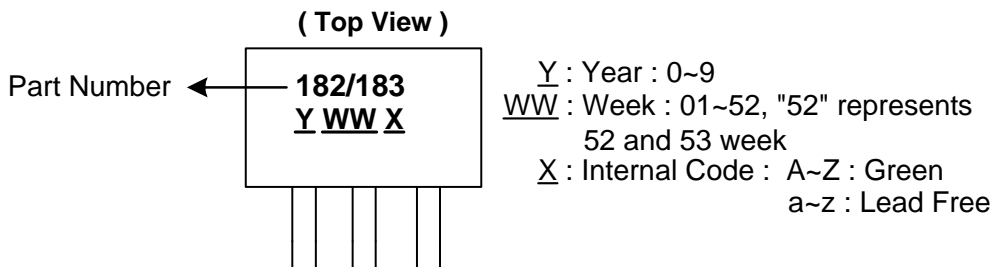

(2) SC59 (Commonly known as SOT23 in Asia)

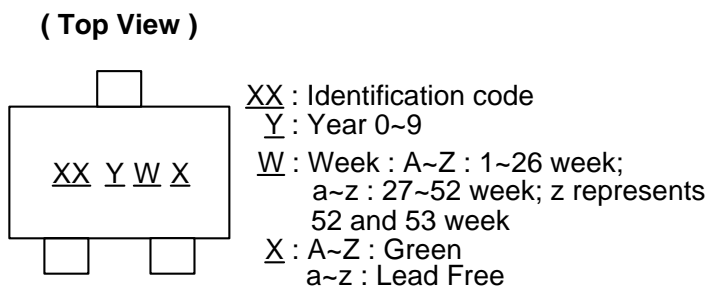

Part Number	Package	Identification Code
AH182	SC59	K2
AH183	SC59	K3

Package Information (All Dimensions in mm)

(1) Package Type: SIP-3L for Bulk only

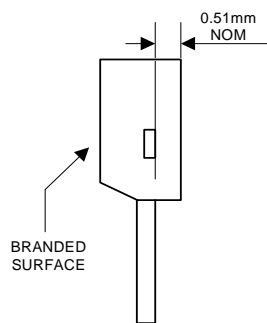

Active Area Depth

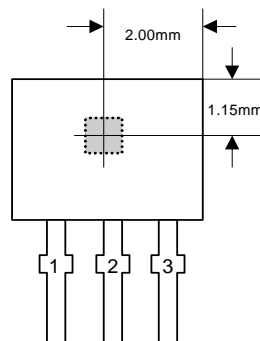

Sensor Location

Package Dimension

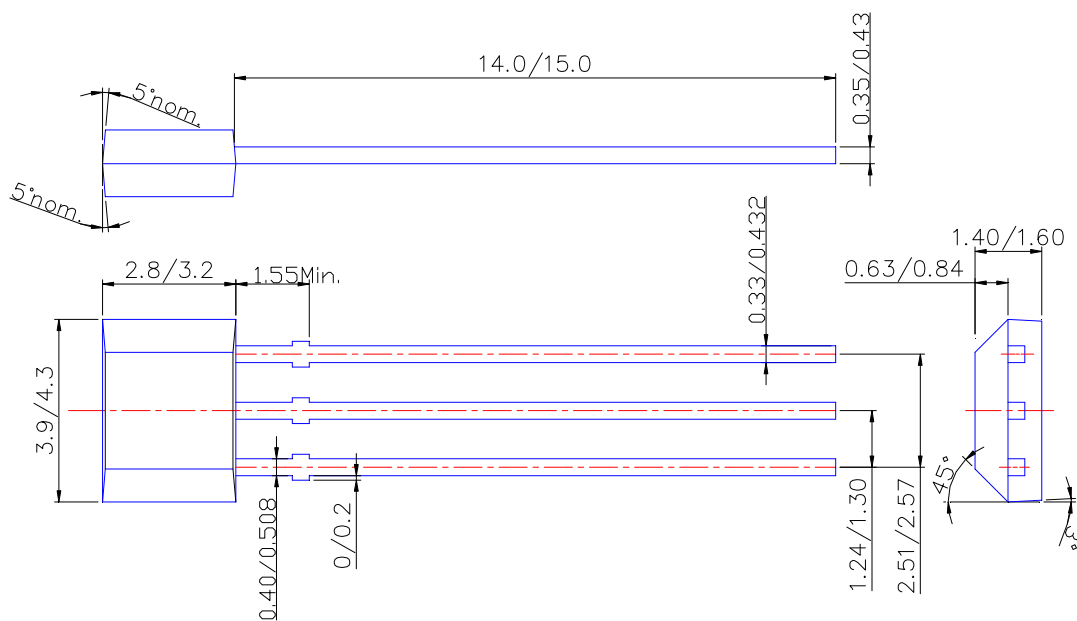

IMPORTANT NOTICE

DIODES INCORPORATED MAKES NO WARRANTY OF ANY KIND, EXPRESS OR IMPLIED, WITH REGARDS TO THIS DOCUMENT, INCLUDING, BUT NOT LIMITED TO, THE IMPLIED WARRANTIES OF MERCHANTABILITY AND FITNESS FOR A PARTICULAR PURPOSE (AND THEIR EQUIVALENTS UNDER THE LAWS OF ANY JURISDICTION).

Diodes Incorporated and its subsidiaries reserve the right to make modifications, enhancements, improvements, corrections or other changes without further notice to this document and any product described herein. Diodes Incorporated does not assume any liability arising out of the application or use of this document or any product described herein; neither does Diodes Incorporated convey any license under its patent or trademark rights, nor the rights of others. Any Customer or user of this document or products described herein in such applications shall assume all risks of such use and will agree to hold Diodes Incorporated and all the companies whose products are represented on Diodes Incorporated website, harmless against all damages.

Diodes Incorporated does not warrant or accept any liability whatsoever in respect of any products purchased through unauthorized sales channel.

Should Customers purchase or use Diodes Incorporated products for any unintended or unauthorized application, Customers shall indemnify and hold Diodes Incorporated and its representatives harmless against all claims, damages, expenses, and attorney fees arising out of, directly or indirectly, any claim of personal injury or death associated with such unintended or unauthorized application.

Products described herein may be covered by one or more United States, international or foreign patents pending. Product names and markings noted herein may also be covered by one or more United States, international or foreign trademarks.

LIFE SUPPORT

Diodes Incorporated products are specifically not authorized for use as critical components in life support devices or systems without the express written approval of the Chief Executive Officer of Diodes Incorporated. As used herein:

A. Life support devices or systems are devices or systems which:

1. are intended to implant into the body, or
2. support or sustain life and whose failure to perform when properly used in accordance with instructions for use provided in the labeling can be reasonably expected to result in significant injury to the user.

B. A critical component is any component in a life support device or system whose failure to perform can be reasonably expected to cause the failure of the life support device or to affect its safety or effectiveness.



Customers represent that they have all necessary expertise in the safety and regulatory ramifications of their life support devices or systems, and acknowledge and agree that they are solely responsible for all legal, regulatory and safety-related requirements concerning their products and any use of Diodes Incorporated products in such safety-critical, life support devices or systems, notwithstanding any devices- or systems-related information or support that may be provided by Diodes Incorporated. Further, Customers must fully indemnify Diodes Incorporated and its representatives against any damages arising out of the use of Diodes Incorporated products in such safety-critical, life support devices or systems.

Copyright © 2009, Diodes Incorporated

www.diodes.com

Looking for pricing, stock, or lifecycle information?

Click below to explore more details on WIN SOURCE:

-  [View AH182-PL-A on WIN SOURCE](#)
-  [Diodes Incorporated Information](#)

Optimize Your Supply Chain with WIN SOURCE Solutions

-  Global Sourcing Solution
-  Obsolete Management
-  Cost Control Management
-  Shortage Management
-  Alternative Solution
-  Excess Inventory Management