



**THE DATASHEET OF  
AH1892-CD4-7**



### Description

The AH1892 is a micropower magnetic range selectable (Bop/Brp) Omnipolar Hall effect switch IC with internal pull up and pull down capability, designed for consumer equipment ranging from portable and battery powered cellular phones and portable PCs to home appliances and industrial applications. To support battery powered equipment and low voltage microcontrollers, the AH1892 can operate over the supply range of 1.6V to 3.6V and uses a hibernating clocking system to minimize the power consumption. The average supply current is only 4.3µA typical at 1.80V. Due to the application diversity, the AH1892 has an 8kV ESD rating on the supply and output pins. To minimize PCB space the AH1892 is packaged in the small CSP package (0.71mm x 0.71mm) or SOT553 leaded package

The output is activated with either a north or south pole of sufficient magnetic field strength. The user can select one of two magnetic sensitivity bands via the BSEL pin without the addition of any external components allowing a flexible but small solution. The band select can be hardwired or be changed on the fly via a logic source such as a micro-controller. When the magnetic flux density (**B**) is larger than operate point (**Bop**), the output will be turned on (pulled low) and held until **B** is lower than release point (**Brp**).

### Features

- Omnipolar operation (North or South pole)
- Programmable operate and release points
- Supply voltage of 1.6V to 3.6V
- Micropower operation
- Chopper stabilized design
  - Superior temperature stability
  - Extremely Low Switch-Point Drift
  - Insensitive to Physical Stress
- No external pull up resistors required
- Good RF noise immunity
- -40°C to +85°C operating temperature
- 8kV ESD on supply and output pins
- Miniature U-WLB07070-4 (CSP 0.71mm x 0.71mm typical) and small low profile SOT553
- **Totally Lead-Free & Fully RoHS Compliant (Notes 1 & 2)**
- **Halogen and Antimony Free. "Green" Device (Note 3)**

Notes: 1. No purposely added lead. Fully EU Directive 2002/95/EC (RoHS) & 2011/65/EU (RoHS 2) compliant.  
 2. See <http://www.diodes.com> for more information about Diodes Incorporated's definitions of Halogen- and Antimony-free, "Green" and Lead-free.  
 3. Halogen- and Antimony-free "Green" products are defined as those which contain <900ppm bromine, <900ppm chlorine (<1500ppm total Br + Cl) and <1000ppm antimony compounds.

### Pin Assignments

(Top View) (Bottom View)

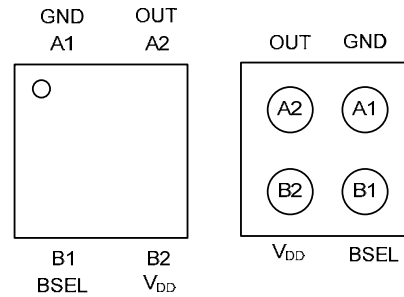

U-WLB0707-4

( Top View )

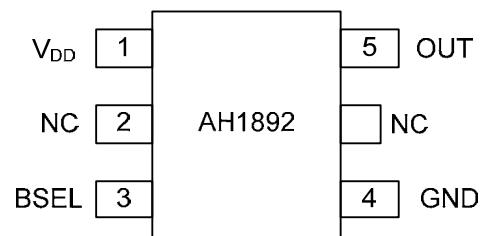

SOT553

### Applications

- Open and close detect for gaming and cellular phones
- Holster and dock detect for cellular phones
- Cover switch in portable and tablet PCs
- Digital still and video cameras
- Tray, door and covers position detect for printers and scanners
- Contact-less switch in consumer and industrial products

## Typical Application Circuit

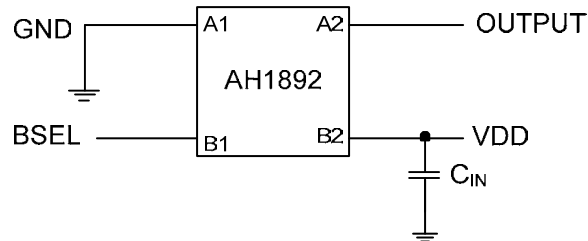

Note :  $C_{IN}$  is for power stabilization and to strengthen the noise immunity, the recommended capacitance is 100nF typical

## Pin Descriptions

Package: U-WLB0707-4

Pin #	Pin Name	Description
A1	GND	Ground
A2	OUTPUT	Output
B1	BSEL	Band Select
B2	V <sub>DD</sub>	Power Supply Voltage

Package: SOT553

Pin #	Pin Name	Description
1	V <sub>DD</sub>	Power Supply Voltage
2	NC	No Connection (Note 4)
3	BSEL	Band Select
4	GND	Ground
5	OUTPUT	Output

Notes: 4. NC is "No Connection" pin and is not connected internally. This pin can be left open or connected to ground.

## Functional Block Diagram

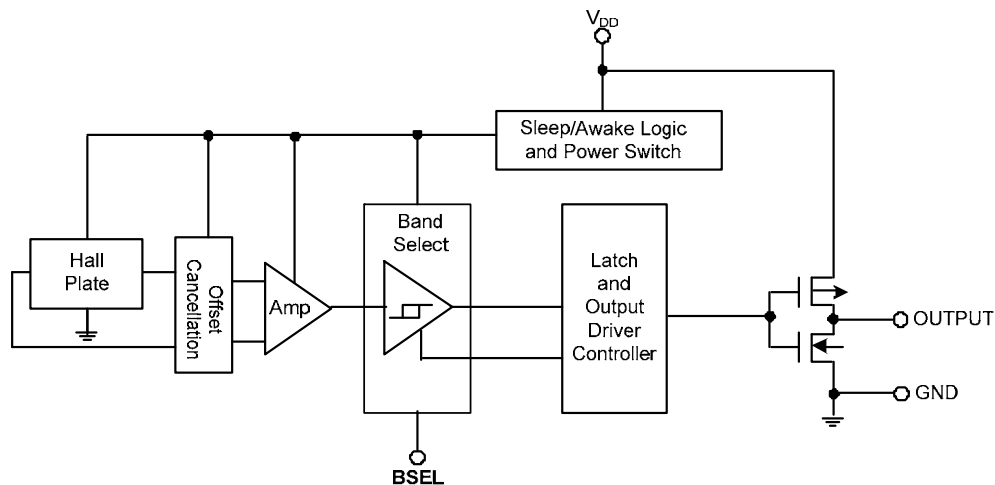

### Absolute Maximum Ratings (T<sub>A</sub> = +25°C, Note 5)

Symbol	Characteristics	Values	Unit	
V <sub>DD</sub>	Supply Voltage (Note 6)	6	V	
V <sub>DD REV</sub>	Reverse Supply Voltage	-0.3	V	
I <sub>OUTPUT</sub>	Output current (source and sink)	2.5	mA	
B	Magnetic Flux Density	Unlimited		
T <sub>S</sub>	Storage Temperature Range	-65 to +150	°C	
P <sub>D</sub>	Package Power Dissipation	U-WLB0707-4	160	mW
		SOT553	230	mW
T <sub>J</sub>	Maximum Junction Temperature	150	°C	
ESD	Human Body Model ESD	V <sub>DD</sub> , GND and OUT pins	8	kV
		BSEL pin	6	kV

- Notes:
- Stresses greater than the 'Absolute Maximum Ratings' specified above, may cause permanent damage to the device. These are stress ratings only; functional operation of the device at these or any other conditions exceeding those indicated in this specification is not implied. Device reliability may be affected by exposure to absolute maximum rating conditions for extended periods of time
  - The absolute maximum V<sub>DD</sub> of 6V is a transient stress rating and is not meant as a functional operating condition. It is not recommended to operate the device at the absolute maximum rated conditions for any period of time.

### Recommended Operating Conditions

Symbol	Characteristics	Conditions	Rating	Unit
V <sub>DD</sub>	Supply Voltage	Operating	1.6 to 3.6	V
T <sub>A</sub>	Operating Temperature Range	Operating	-40 to +85	°C

### Electrical Characteristics (T<sub>A</sub> = +25°C, V<sub>DD</sub> = 1.8V, unless otherwise specified.)

Symbol	Characteristics	Conditions	Min	Typ	Max	Unit
V <sub>OL</sub>	Output low voltage (on)	I <sub>OUT</sub> = 1mA		0.1	0.2	V
V <sub>OH</sub>	Output high voltage (off)	I <sub>OUT</sub> = -1mA	V <sub>DD</sub> - 0.2	V <sub>DD</sub> - 0.1		V
BLsel	Band select low band		0		0.5	V
BHsel	Band select high band		1.4		3.6	V
R <sub>U_BSEL</sub>	BSEL pin internal pull-up resistor	(Note 7)		50		kΩ
I <sub>DD</sub> (awake)	Supply current	During 'awake' period		2.1		mA
I <sub>DD</sub> (sleep)		During 'sleep' period		2.5		μA
I <sub>DD</sub> (avg)	Average supply current	V <sub>DD</sub> = 1.8V		4.3	8.0	μA
I <sub>DD</sub> (avg)		V <sub>DD</sub> = 3.6V		7.2	13.0	μA
T <sub>awake</sub>	Awake active pulse width	(Note 8)		50	100	μs
T <sub>period</sub>	Awake period	(Note 8)		50	100	ms
D.C.	Duty cycle			0.1		%
T <sub>Band</sub>	Band transition time	(Note 9)		100.0	200.1	ms

- Notes:
- BSEL pin internal pull-up resistor is only active during AWAKE time.
  - When power is initially on, the operating V<sub>DD</sub> (1.6V to 3.6V) must be applied to guarantee the output sampling. The output state is valid after the second operating phase (typical 100ms).
  - Transition time varies dependant on the timing of BSEL activation during the sleep and awake phases.

**Electrical Characteristics (cont.)**

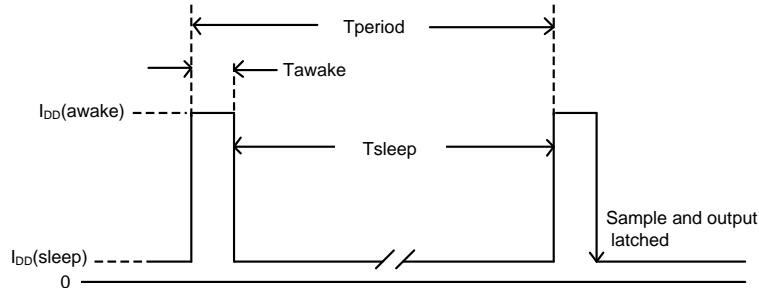

**Magnetic Characteristics (T<sub>A</sub> = +25°C, V<sub>DD</sub> = 1.6V to 3.6V, Note 10)**

(1mT=10 Gauss)

BSEL	Symbol	Characteristics	Min	Typ	Max	Unit
Low	Bops <sub>LB</sub> (south pole to brand side)	Low Band - Operation Point	18	35	55	Gauss
Low	Bopn <sub>LB</sub> (north pole to brand side)		-55	-35	-18	
Low	Brps <sub>LB</sub> (south pole to brand side)	Low Band - Release Point	12	25	45	
Low	Brpn <sub>LB</sub> (north pole to brand side)		-45	-25	-12	
High	Bops <sub>HB</sub> (south pole to brand side)	High Band - Operation Point	43	60	80	
High	Bopn <sub>HB</sub> (north pole to brand side)		-80	-60	-43	
High	Brps <sub>HB</sub> (south pole to brand side)	High Band - Release Point	35	50	70	
High	Brpn <sub>HB</sub> (north pole to brand side)		-70	-50	-35	
-	Bhy ( Bopx - Brpx )	Hysteresis	-	10	-	

Notes: 10. Magnetic characteristics may vary with operating temperature and after soldering.

The AH1892 includes a band select pin (BSEL) so that the operate (Bops and Bopn) and release (Brps and Brpn) points can be adjusted between two pre-defined ranges. The BSEL can be hard wired within the application circuit or the band can be selected on the fly by using the BSEL pin as a logic input. This feature allows the AH1892 sensitivity to be changed by firmware within the application without the addition of any external components. If the BSEL pin is left open circuit the AH1892 defaults to high band.

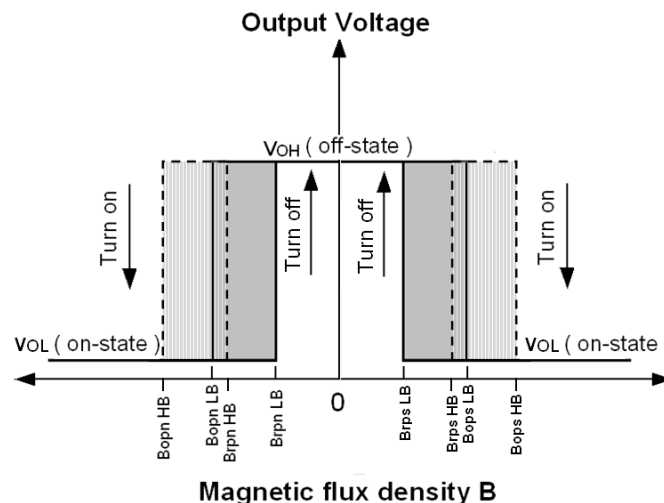

## Application Note

### Applications Circuit One – Low Band

Connecting the BSEL pin to ground permanently configures the AH1892 into its high sensitivity mode, requiring a reduced magnetic flux density to activate its output (Low Band).

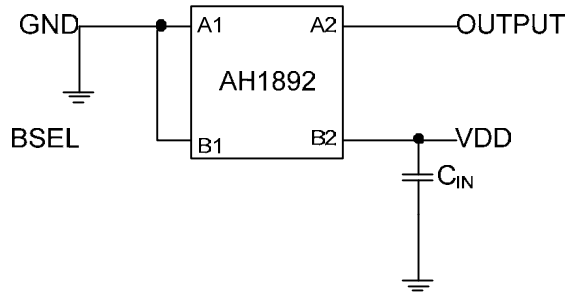

### Applications Circuit Two – High Band

Connecting the BSEL pin to Vdd or to a voltage greater than 1.4V or leaving the BSEL pin unconnected configures the AH1892 into its low sensitivity mode, requiring a higher magnetic flux density to activate its output (High Band).

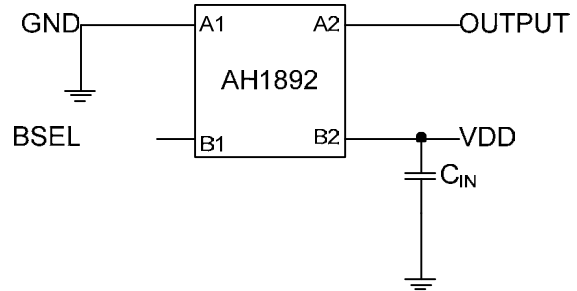
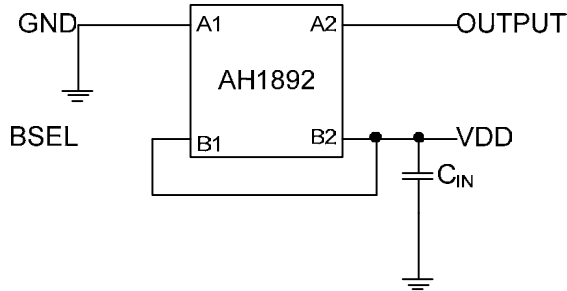

### Applications Circuit Three – Adjustable Sensitivity

To enhance flexibility within the application, the sensitivity can be adjusted with a standard logic signal allowing it to be controlled by a micro-controller or a logic source. This allows the sensitivity to be changed within the application without a hardware change. Whenever the sensitivity band selection is changed, the band selection changeover should be allowed to complete for the output to be valid.

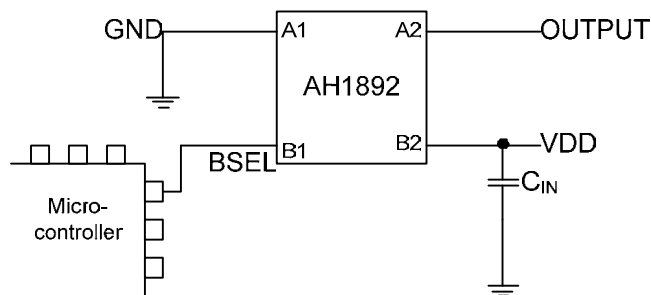

**Application Note (cont.)**

**Bands Select Change Timing and Valid Output**

Whenever band selection BSEL pin input is changed, allow for band selection changeover to complete and stabilize. The output is valid only after the second complete operating 'awake' phase. Time taken for the output to be valid, after the BSEL change, depends on timing of BSEL change during the sleep and awake phase; this time can range from 100ms typical and 200.1ms maximum.

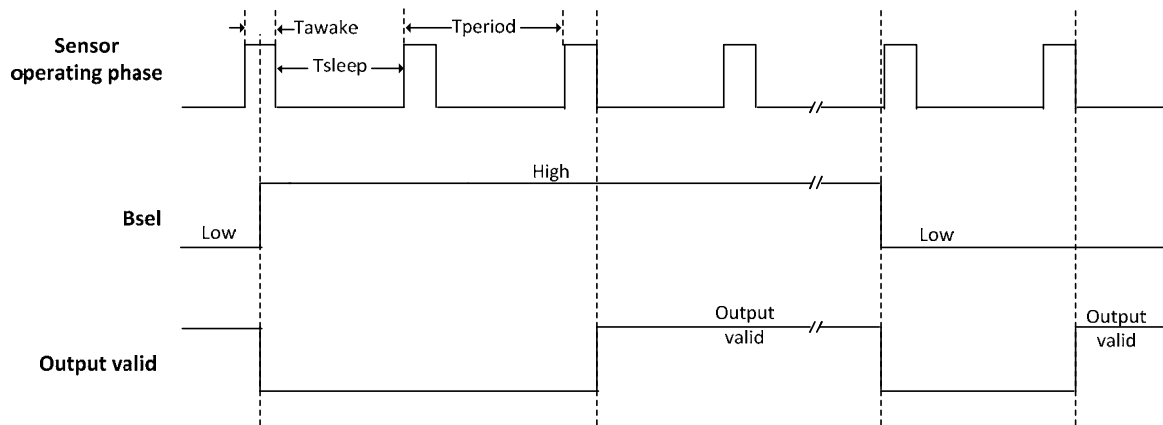

**Typical Operating Characteristics**

Typical switch points characteristics in low band (BSEL = Low) and high band (BSEL = High)

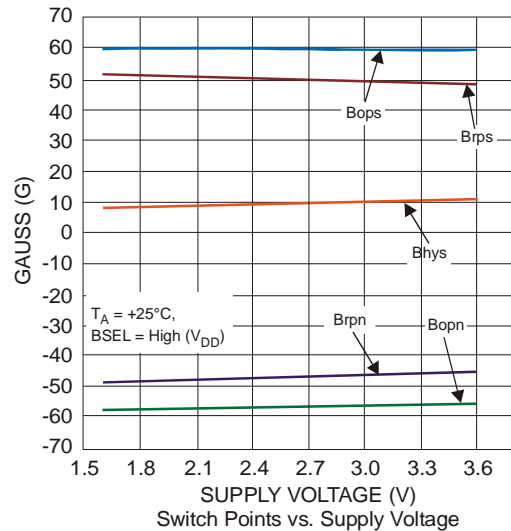
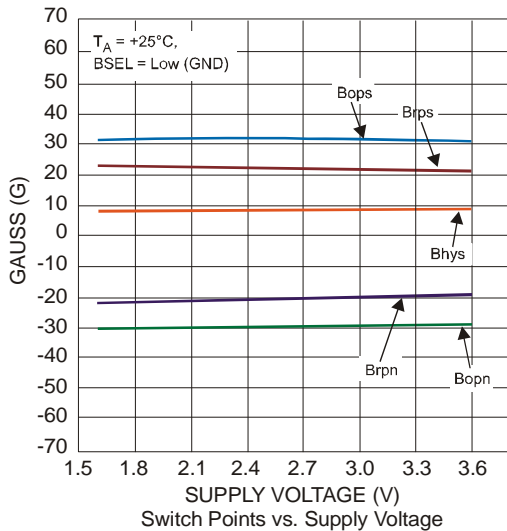
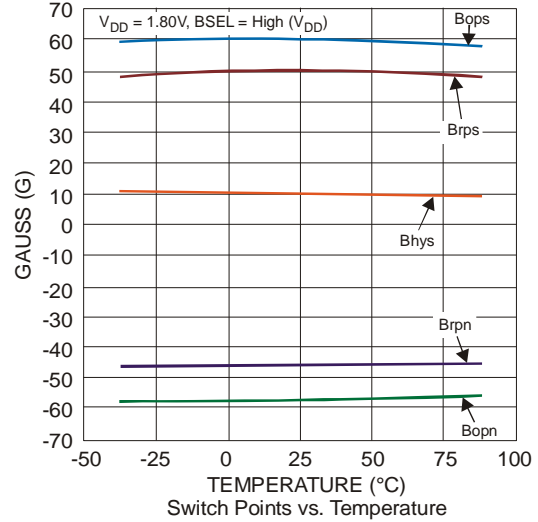
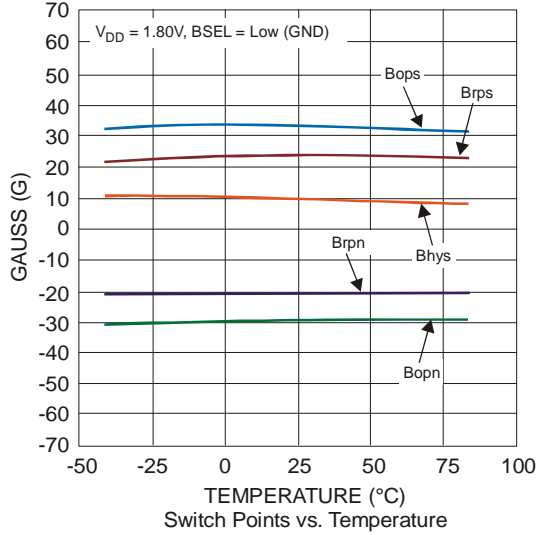

**Average Supply Current I<sub>DD</sub>(avg)**

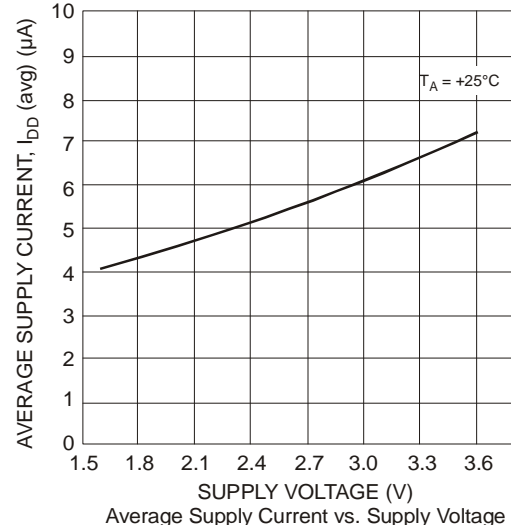
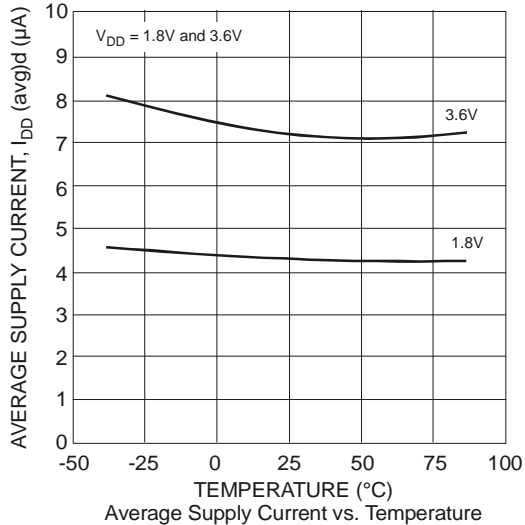

**Ordering Information**

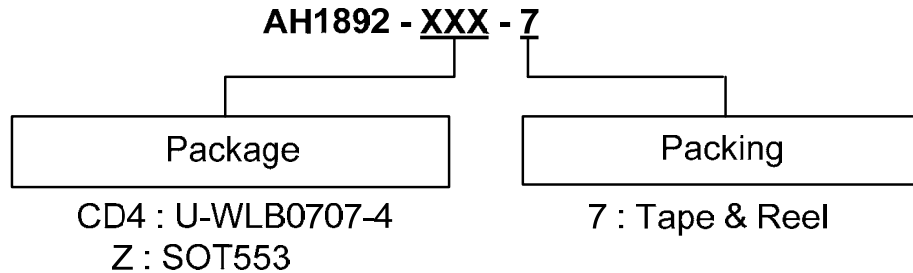

Device	Package Code	Packaging (Note 11)	7" Tape and Reel	
			Quantity	Part Number Suffix
AH1892-CD4-7	CD4	U-WLB0707-4	3000/Tape & Reel	-7
AH1892-Z-7	Z	SOT553	3000/Tape & Reel	-7

Notes: 11. Pad layout as shown on Diodes Inc. suggested pad layout document AP02001, which can be found on our website at <http://www.diodes.com/datasheets/ap02001.pdf>.

**Marking Information**

**(1) Package type: U-WLB0707-4**

(Top View)

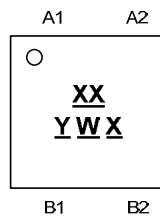

XX : Identification Code  
Y : Year : 0~9  
W : Week : A~Z : 1~26 week;  
a~z : 27~52 week; z represents 52 and 53 week  
X : Internal Code

Part Number	Package	Identification Code
AH1892-CD4-7	U-WLB0707-4	B2

**(2) Package type: SOT553**

(Top View)

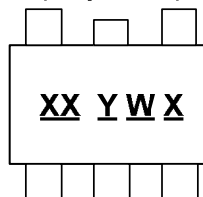

XX : Identification Code  
Y : Year : 0~9  
W : Week : A~Z : 1~26 week;  
a~z : 27~52 week; z represents 52 and 53 week  
X : Internal Code

Part Number	Package	Identification Code
AH1892-Z-7	SOT553	B2

**Package Outline Dimensions (All Dimensions in mm)**

(1) Package type: U-WLB0707-4

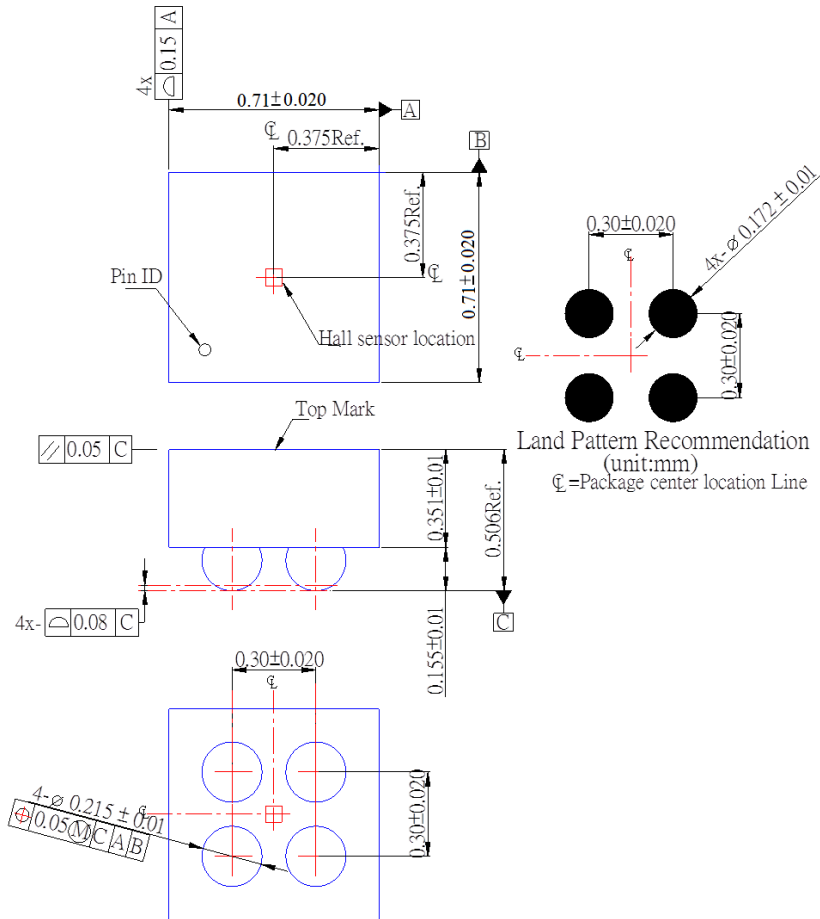



**IMPORTANT NOTICE**

DIODES INCORPORATED MAKES NO WARRANTY OF ANY KIND, EXPRESS OR IMPLIED, WITH REGARDS TO THIS DOCUMENT, INCLUDING, BUT NOT LIMITED TO, THE IMPLIED WARRANTIES OF MERCHANTABILITY AND FITNESS FOR A PARTICULAR PURPOSE (AND THEIR EQUIVALENTS UNDER THE LAWS OF ANY JURISDICTION).

Diodes Incorporated and its subsidiaries reserve the right to make modifications, enhancements, improvements, corrections or other changes without further notice to this document and any product described herein. Diodes Incorporated does not assume any liability arising out of the application or use of this document or any product described herein; neither does Diodes Incorporated convey any license under its patent or trademark rights, nor the rights of others. Any Customer or user of this document or products described herein in such applications shall assume all risks of such use and will agree to hold Diodes Incorporated and all the companies whose products are represented on Diodes Incorporated website, harmless against all damages.

Diodes Incorporated does not warrant or accept any liability whatsoever in respect of any products purchased through unauthorized sales channel.

Should Customers purchase or use Diodes Incorporated products for any unintended or unauthorized application, Customers shall indemnify and hold Diodes Incorporated and its representatives harmless against all claims, damages, expenses, and attorney fees arising out of, directly or indirectly, any claim of personal injury or death associated with such unintended or unauthorized application.

Products described herein may be covered by one or more United States, international or foreign patents pending. Product names and markings noted herein may also be covered by one or more United States, international or foreign trademarks.

**LIFE SUPPORT**

Diodes Incorporated products are specifically not authorized for use as critical components in life support devices or systems without the express written approval of the Chief Executive Officer of Diodes Incorporated. As used herein:

A. Life support devices or systems are devices or systems which:

1. are intended to implant into the body, or
2. support or sustain life and whose failure to perform when properly used in accordance with instructions for use provided in the labeling can be reasonably expected to result in significant injury to the user.

B. A critical component is any component in a life support device or system whose failure to perform can be reasonably expected to cause the failure of the life support device or to affect its safety or effectiveness.



Customers represent that they have all necessary expertise in the safety and regulatory ramifications of their life support devices or systems, and acknowledge and agree that they are solely responsible for all legal, regulatory and safety-related requirements concerning their products and any use of Diodes Incorporated products in such safety-critical, life support devices or systems, notwithstanding any devices- or systems-related information or support that may be provided by Diodes Incorporated. Further, Customers must fully indemnify Diodes Incorporated and its representatives against any damages arising out of the use of Diodes Incorporated products in such safety-critical, life support devices or systems.

Copyright © 2012, Diodes Incorporated

[www.diodes.com](http://www.diodes.com)

## Looking for pricing, stock, or lifecycle information?

Click below to explore more details on WIN SOURCE:

-  [View AH1892-CD4-7 on WIN SOURCE](#)
-  [Diodes Incorporated Information](#)

## Optimize Your Supply Chain with WIN SOURCE Solutions

-  Global Sourcing Solution
-  Obsolete Management
-  Cost Control Management
-  Shortage Management
-  Alternative Solution
-  Excess Inventory Management