



**THE DATASHEET OF
MC74AC02DG**



MC74AC02, MC74ACT02

Quad 2-Input NOR Gate

High-Performance Silicon-Gate CMOS

Features

- Outputs Source/Sink 24 mA
- 'ACT02 Has TTL Compatible Inputs
- These are Pb-Free Devices

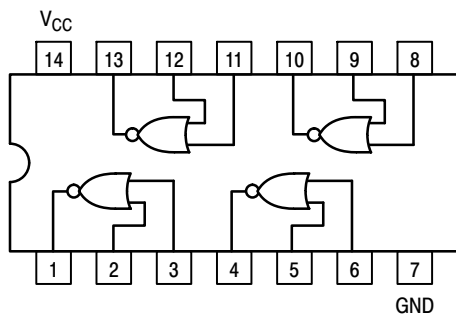

Figure 1. Pinout: 14-Lead Packages Conductors (Top View)



ON Semiconductor®

www.onsemi.com

MARKING DIAGRAMS

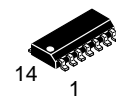

SOIC-14
D SUFFIX
CASE 751A

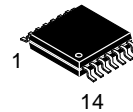
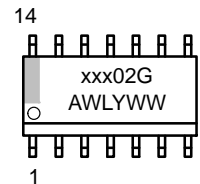

TSSOP-14
DT SUFFIX
CASE 948G

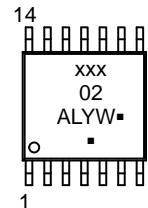

xxx = AC or ACT
A = Assembly Location
WL or L = Wafer Lot
Y = Year
WW or W = Work Week
G or ■ = Pb-Free Package

(Note: Microdot may be in either location)

ORDERING INFORMATION

See detailed ordering and shipping information in the package dimensions section on page 5 of this data sheet.

MC74AC02, MC74ACT02

MAXIMUM RATINGS

Symbol	Parameter	Value	Unit
V _{CC}	DC Supply Voltage	-0.5 to +7.0	V
V _I	DC Input Voltage	-0.5 ≤ V _I ≤ V _{CC} + 0.5	V
V _O	DC Output Voltage (Note 1)	-0.5 ≤ V _O ≤ V _{CC} + 0.5	V
I _{IK}	DC Input Diode Current	±20	mA
I _{OK}	DC Output Diode Current	±50	mA
I _O	DC Output Sink/Source Current	±50	mA
I _{CC}	DC Supply Current per Output Pin	±50	mA
I _{GND}	DC Ground Current per Output Pin	±50	mA
T _{STG}	Storage Temperature Range	-65 to +150	°C
T _L	Lead temperature, 1 mm from Case for 10 Seconds	260	°C
T _J	Junction temperature under Bias	+150	°C
θ _{JA}	Thermal Resistance (Note 2)	SOIC TSSOP 125 170	°C/W
P _D	Power Dissipation in Still Air at 85°C	SOIC TSSOP 125 170	mW
MSL	Moisture Sensitivity	Level 1	
F _R	Flammability Rating	Oxygen Index: 30% – 35% UL 94 V-0 @ 0.125 in	
V _{ESD}	ESD Withstand Voltage	Human Body Model (Note 3) Machine Model (Note 4) Charged Device Model (Note 5) > 2000 > 200 > 1000	V
I _{Latch-Up}	Latch-Up Performance	Above V _{CC} and Below GND at 85°C (Note 6)	±100 mA

Stresses exceeding those listed in the Maximum Ratings table may damage the device. If any of these limits are exceeded, device functionality should not be assumed, damage may occur and reliability may be affected.

1. I_O absolute maximum rating must be observed.
2. The package thermal impedance is calculated in accordance with JESD51-7.
3. Tested to EIA/JESD22-A114-A.
4. Tested to EIA/JESD22-A115-A.
5. Tested to JESD22-C101-A.
6. Tested to EIA/JESD78.

RECOMMENDED OPERATING CONDITIONS

Symbol	Parameter	Min	Typ	Max	Unit	
V _{CC}	Supply Voltage	'AC	2.0	5.0	6.0	V
		'ACT	4.5	5.0	5.5	
V _{in} , V _{out}	DC Input Voltage, Output Voltage (Ref. to GND)	0	-	V _{CC}	V	
t _r , t _f	Input Rise and Fall Time (Note 1) 'AC Devices except Schmitt Inputs	V _{CC} @ 3.0 V	-	150	-	ns/V
		V _{CC} @ 4.5 V	-	40	-	
		V _{CC} @ 5.5 V	-	25	-	
t _r , t _f	Input Rise and Fall Time (Note 2) 'ACT Devices except Schmitt Inputs	V _{CC} @ 4.5 V	-	10	-	ns/V
		V _{CC} @ 5.5 V	-	8.0	-	
T _J	Junction Temperature (PDIP)	-	-	140	°C	
T _A	Operating Ambient Temperature Range	-40	25	85	°C	
I _{OH}	Output Current – High	-	-	-24	mA	
I _{OL}	Output Current – Low	-	-	24	mA	

Functional operation above the stresses listed in the Recommended Operating Ranges is not implied. Extended exposure to stresses beyond the Recommended Operating Ranges limits may affect device reliability.

1. V_{in} from 30% to 70% V_{CC}; see individual Data Sheets for devices that differ from the typical input rise and fall times.
2. V_{in} from 0.8 V to 2.0 V; see individual Data Sheets for devices that differ from the typical input rise and fall times.

MC74AC02, MC74ACT02

DC CHARACTERISTICS

Symbol	Parameter	V _{CC} (V)	74AC		74AC		Unit	Conditions
			T _A = +25°C		T _A = -40°C to +85°C			
			Typ	Guaranteed Limits				
V _{IH}	Minimum High Level Input Voltage	3.0	1.5	2.1	2.1		V	V _{OUT} = 0.1 V or V _{CC} - 0.1 V
		4.5	2.25	3.15	3.15			
		5.5	2.75	3.85	3.85			
V _{IL}	Maximum Low Level Input Voltage	3.0	1.5	0.9	0.9		V	V _{OUT} = 0.1 V or V _{CC} - 0.1 V
		4.5	2.25	1.35	1.35			
		5.5	2.75	1.65	1.65			
V _{OH}	Minimum High Level Output Voltage	3.0	2.99	2.9	2.9		V	I _{OUT} = -50 μA
		4.5	4.49	4.4	4.4			
		5.5	5.49	5.4	5.4			
		3.0	-	2.56	2.46		V	*V _{IN} = V _{IL} or V _{IH} -12 mA I _{OH} -24 mA -24 mA
		4.5	-	3.86	3.76			
		5.5	-	4.86	4.76			
V _{OL}	Maximum Low Level Output Voltage	3.0	0.002	0.1	0.1		V	I _{OUT} = 50 μA
		4.5	0.001	0.1	0.1			
		5.5	0.001	0.1	0.1			
		3.0	-	0.36	0.44		V	*V _{IN} = V _{IL} or V _{IH} 12 mA I _{OL} 24 mA 24 mA
		4.5	-	0.36	0.44			
		5.5	-	0.36	0.44			
I _{IN}	Maximum Input Leakage Current	5.5	-	±0.1	±1.0		μA	V _I = V _{CC} , GND
I _{OLD}	†Minimum Dynamic Output Current	5.5	-	-	75		mA	V _{OLD} = 1.65 V Max
I _{OHD}		5.5	-	-	-75		mA	V _{OHD} = 3.85 V Min
I _{CC}	Maximum Quiescent Supply Current	5.5	-	4.0	40		μA	V _{IN} = V _{CC} or GND

Product parametric performance is indicated in the Electrical Characteristics for the listed test conditions, unless otherwise noted. Product performance may not be indicated by the Electrical Characteristics if operated under different conditions.

*All outputs loaded; thresholds on input associated with output under test.

†Maximum test duration 2.0 ms, one output loaded at a time.

NOTE: I_{IN} and I_{CC} @ 3.0 V are guaranteed to be less than or equal to the respective limit @ 5.5 V V_{CC}.

AC CHARACTERISTICS

Symbol	Parameter	V _{CC} * (V)	74AC			74AC		Unit	Fig. No.
			T _A = +25°C C _L = 50 pF			T _A = -40°C to +85°C C _L = 50 pF			
			Min	Typ	Max	Min	Max		
t _{PLH}	Propagation Delay	3.3	1.5	5.0	7.5	1.0	8.0	ns	3-5
		5.0	1.5	4.0	6.0	1.0	6.5		
t _{PHL}	Propagation Delay	3.3	1.5	5.0	7.5	1.0	8.0	ns	3-5
		5.0	1.5	4.5	6.5	1.0	7.0		

*Voltage Range 3.3 V is 3.3 V ±0.3 V.

Voltage Range 5.0 V is 5.0 V ±0.5 V.

MC74AC02, MC74ACT02

DC CHARACTERISTICS

Symbol	Parameter	V _{CC} (V)	74ACT		74ACT		Unit	Conditions
			T _A = +25°C		T _A = -40°C to +85°C			
			Typ	Guaranteed Limits				
V _{IH}	Minimum High Level Input Voltage	4.5	1.5	2.0	2.0	V	V _{OUT} = 0.1 V or V _{CC} - 0.1 V	
		5.5	1.5	2.0	2.0			
V _{IL}	Maximum Low Level Input Voltage	4.5	1.5	0.8	0.8	V	V _{OUT} = 0.1 V or V _{CC} - 0.1 V	
		5.5	1.5	0.8	0.8			
V _{OH}	Minimum High Level Output Voltage	4.5	4.49	4.4	4.4	V	I _{OUT} = -50 μA	
		5.5	5.49	5.4	5.4			
		4.5	-	3.86	3.76	V	*V _{IN} = V _{IL} or V _{IH} I _{OH} = -24 mA	
		5.5	-	4.86	4.76			
V _{OL}	Maximum Low Level Output Voltage	4.5	0.001	0.1	0.1	V	I _{OUT} = 50 μA	
		5.5	0.001	0.1	0.1			
		4.5	-	0.36	0.44	V	*V _{IN} = V _{IL} or V _{IH} I _{OL} = 24 mA	
		5.5	-	0.36	0.44			
I _{IN}	Maximum Input Leakage Current	5.5	-	±0.1	±1.0	μA	V _I = V _{CC} , GND	
ΔI _{CC} T	Additional Max. I _{CC} /Input	5.5	0.6	-	1.5	mA	V _I = V _{CC} - 2.1 V	
I _{OLD}	†Minimum Dynamic Output Current	5.5	-	-	75	mA	V _{OLD} = 1.65 V Max	
I _{OHD}		5.5	-	-	-75	mA	V _{OHD} = 3.85 V Min	
I _{CC}	Maximum Quiescent Supply Current	5.5	-	4.0	40	μA	V _{IN} = V _{CC} or GND	

Product parametric performance is indicated in the Electrical Characteristics for the listed test conditions, unless otherwise noted. Product performance may not be indicated by the Electrical Characteristics if operated under different conditions.

*All outputs loaded; thresholds on input associated with output under test.

†Maximum test duration 2.0 ms, one output loaded at a time.

AC CHARACTERISTICS

Symbol	Parameter	V _{CC} * (V)	74ACT			74ACT		Unit	Fig. No.
			T _A = +25°C C _L = 50 pF			T _A = -40°C to +85°C C _L = 50 pF			
			Min	Typ	Max	Min	Max		
t _{PLH}	Propagation Delay	5.0	1.5	-	8.5	1.0	9.0	ns	3-6
t _{PHL}	Propagation Delay	5.0	1.5	-	9.5	1.0	10	ns	3-6

*Voltage Range 5.0 V is 5.0 V ±0.5 V.

CAPACITANCE

Symbol	Parameter	Value Typ	Unit	Test Conditions
C _{IN}	Input Capacitance	4.5	pF	V _{CC} = 5.0 V
C _{PD}	Power Dissipation Capacitance	30	pF	V _{CC} = 5.0 V

MC74AC02, MC74ACT02

DEVICE ORDERING INFORMATION

Device	Package	Shipping†
MC74AC02DG	SOIC-14 (Pb-Free)	55 Units / Rail
MC74AC02DR2G	SOIC-14 (Pb-Free)	2500 / Tape & Reel
MC74ACT02DG	SOIC-14 (Pb-Free)	55 Units / Rail
MC74ACT02DR2G	SOIC-14 (Pb-Free)	2500 / Tape & Reel
MC74AC02DTR2G	TSSOP-14 (Pb-Free)	2500 / Tape & Reel
MC74ACT02DTR2G	TSSOP-14 (Pb-Free)	2500 / Tape & Reel

†For information on tape and reel specifications, including part orientation and tape sizes, please refer to our Tape and Reel Packaging Specifications Brochure, BRD8011/D.

MC74AC02, MC74ACT02

PACKAGE DIMENSIONS

SOIC-14 NB
CASE 751A-03
ISSUE K

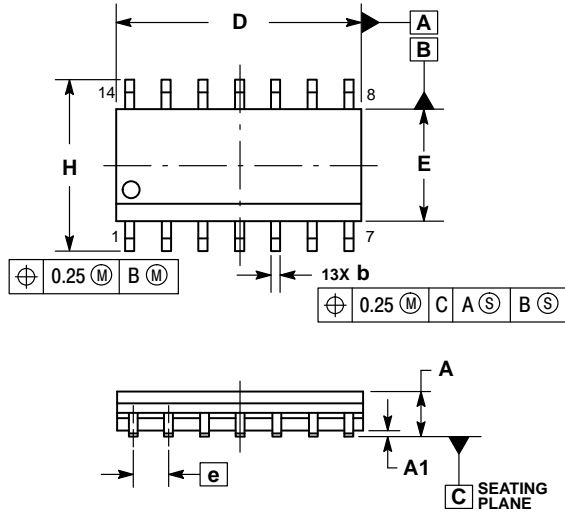

NOTES:

1. DIMENSIONING AND TOLERANCING PER ASME Y14.5M, 1994.
2. CONTROLLING DIMENSION: MILLIMETERS.
3. DIMENSION b DOES NOT INCLUDE DAMBAR PROTRUSION. ALLOWABLE PROTRUSION SHALL BE 0.13 TOTAL IN EXCESS OF AT MAXIMUM MATERIAL CONDITION.
4. DIMENSIONS D AND E DO NOT INCLUDE MOLD PROTRUSIONS.
5. MAXIMUM MOLD PROTRUSION 0.15 PER SIDE.

DIM	MILLIMETERS		INCHES	
	MIN	MAX	MIN	MAX
A	1.35	1.75	0.054	0.068
A1	0.10	0.25	0.004	0.010
A3	0.19	0.25	0.008	0.010
b	0.35	0.49	0.014	0.019
D	8.55	8.75	0.337	0.344
E	3.80	4.00	0.150	0.157
e	1.27 BSC		0.050 BSC	
H	5.80	6.20	0.228	0.244
h	0.25	0.50	0.010	0.019
L	0.40	1.25	0.016	0.049
M	0°	7°	0°	7°

SOLDERING FOOTPRINT*

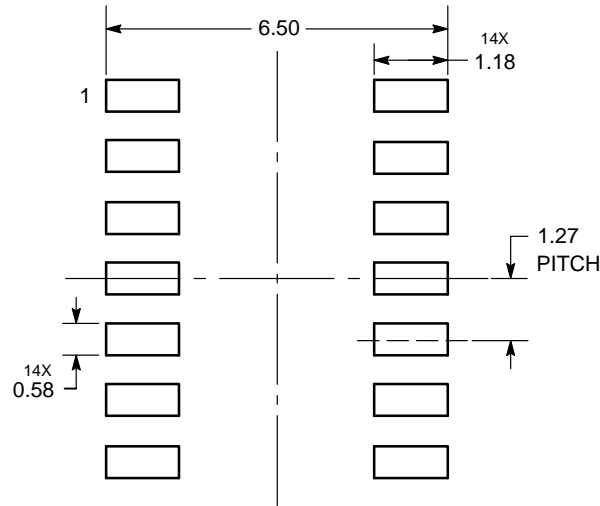

DIMENSIONS: MILLIMETERS

*For additional information on our Pb-Free strategy and soldering details, please download the ON Semiconductor Soldering and Mounting Techniques Reference Manual, SOLDERRM/D.

MC74AC02, MC74ACT02

PACKAGE DIMENSIONS

TSSOP-14
CASE 948G
ISSUE B



NOTES:

1. DIMENSIONING AND TOLERANCING PER ANSI Y14.5M, 1982.
2. CONTROLLING DIMENSION: MILLIMETER.
3. DIMENSION A DOES NOT INCLUDE MOLD FLASH, PROTRUSIONS OR GATE BURRS. MOLD FLASH OR GATE BURRS SHALL NOT EXCEED 0.15 (0.006) PER SIDE.
4. DIMENSION B DOES NOT INCLUDE INTERLEAD FLASH OR PROTRUSION. INTERLEAD FLASH OR PROTRUSION SHALL NOT EXCEED 0.25 (0.010) PER SIDE.
5. DIMENSION K DOES NOT INCLUDE DAMBAR PROTRUSION. ALLOWABLE DAMBAR PROTRUSION SHALL BE 0.08 (0.003) TOTAL IN EXCESS OF THE K DIMENSION AT MAXIMUM MATERIAL CONDITION.
6. TERMINAL NUMBERS ARE SHOWN FOR REFERENCE ONLY.
7. DIMENSION A AND B ARE TO BE DETERMINED AT DATUM PLANE -W-.

DIM	MILLIMETERS		INCHES	
	MIN	MAX	MIN	MAX
A	4.90	5.10	0.193	0.200
B	4.30	4.50	0.169	0.177
C	---	1.20	---	0.047
D	0.05	0.15	0.002	0.006
F	0.50	0.75	0.020	0.030
G	0.65 BSC		0.026 BSC	
H	0.50	0.60	0.020	0.024
J	0.09	0.20	0.004	0.008
J1	0.09	0.16	0.004	0.006
K	0.19	0.30	0.007	0.012
K1	0.19	0.25	0.007	0.010
L	6.40 BSC		0.252 BSC	
M	0°	8°	0°	8°

SOLDERING FOOTPRINT*



*For additional information on our Pb-Free strategy and soldering details, please download the ON Semiconductor Soldering and Mounting Techniques Reference Manual, SOLDERRM/D.

MC74AC02, MC74ACT02

ON Semiconductor and the  are registered trademarks of Semiconductor Components Industries, LLC (SCILLC) or its subsidiaries in the United States and/or other countries. SCILLC owns the rights to a number of patents, trademarks, copyrights, trade secrets, and other intellectual property. A listing of SCILLC's product/patent coverage may be accessed at www.onsemi.com/site/pdf/Patent-Marking.pdf. SCILLC reserves the right to make changes without further notice to any products herein. SCILLC makes no warranty, representation or guarantee regarding the suitability of its products for any particular purpose, nor does SCILLC assume any liability arising out of the application or use of any product or circuit, and specifically disclaims any and all liability, including without limitation special, consequential or incidental damages. "Typical" parameters which may be provided in SCILLC data sheets and/or specifications can and do vary in different applications and actual performance may vary over time. All operating parameters, including "Typicals" must be validated for each customer application by customer's technical experts. SCILLC does not convey any license under its patent rights nor the rights of others. SCILLC products are not designed, intended, or authorized for use as components in systems intended for surgical implant into the body, or other applications intended to support or sustain life, or for any other application in which the failure of the SCILLC product could create a situation where personal injury or death may occur. Should Buyer purchase or use SCILLC products for any such unintended or unauthorized application, Buyer shall indemnify and hold SCILLC and its officers, employees, subsidiaries, affiliates, and distributors harmless against all claims, costs, damages, and expenses, and reasonable attorney fees arising out of, directly or indirectly, any claim of personal injury or death associated with such unintended or unauthorized use, even if such claim alleges that SCILLC was negligent regarding the design or manufacture of the part. SCILLC is an Equal Opportunity/Affirmative Action Employer. This literature is subject to all applicable copyright laws and is not for resale in any manner.

PUBLICATION ORDERING INFORMATION

LITERATURE FULFILLMENT:

Literature Distribution Center for ON Semiconductor
P.O. Box 5163, Denver, Colorado 80217 USA
Phone: 303-675-2175 or 800-344-3860 Toll Free USA/Canada
Fax: 303-675-2176 or 800-344-3867 Toll Free USA/Canada
Email: orderlit@onsemi.com

N. American Technical Support: 800-282-9855 Toll Free
USA/Canada
Europe, Middle East and Africa Technical Support:
Phone: 421 33 790 2910
Japan Customer Focus Center
Phone: 81-3-5817-1050

ON Semiconductor Website: www.onsemi.com
Order Literature: <http://www.onsemi.com/orderlit>
For additional information, please contact your local
Sales Representative

Looking for pricing, stock, or lifecycle information?

Click below to explore more details on WIN SOURCE:

 [View MC74AC02DG](#) on WIN SOURCE

 [ON Semiconductor](#) Information

Optimize Your Supply Chain with WIN SOURCE Solutions

-  Global Sourcing Solution
-  Obsolete Management
-  Cost Control Management
-  Shortage Management
-  Alternative Solution
-  Excess Inventory Management