



**THE DATASHEET OF
AH49EZ3-G1**



LINEAR HALL-EFFECT IC

AH49E

General Description

The AH49E is a small, versatile linear Hall-effect device that is operated by the magnetic field from a permanent magnet or an electromagnet. The output voltage is set by the supply voltage and varies in proportion to the strength of the magnetic field.

The integrated circuitry features low noise output, which makes it unnecessary to use external filtering. It also includes precision resistors to provide increased temperature stability and accuracy. The operating temperature range of these linear Hall sensors is -40°C to 85°C, appropriate for commercial, consumer and industrial applications.

The AH49E is available in standard TO-92S and SOT-23-3 packages.

Features

- Miniature Construction
- Power Consumption of 3.5mA at $V_{CC}=5V$ for Energy Efficiency
- Single Current Sourcing Output
- Linear Output for Circuit Design Flexibility
- Low Noise Output Virtually Eliminates the Need for Filtering
- A Stable and Accurate Output
- Temperature Range of -40°C to 85°C
- Responds to Either Positive or Negative Gauss

Applications

- Current Sensing
- Motor Control
- Position Sensing
- Magnetic Code Reading
- Ferrous Metal Detector
- Vibration Sensing
- Liquid Level Sensing
- Weight Sensing

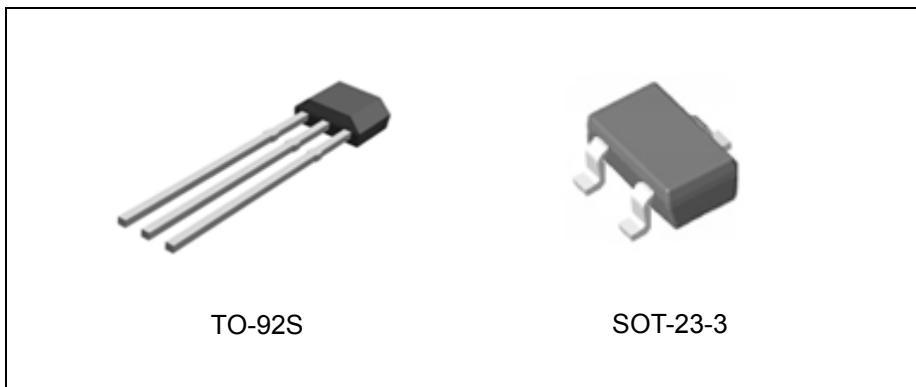

Figure 1. Package Types of AH49E

Pin Configuration

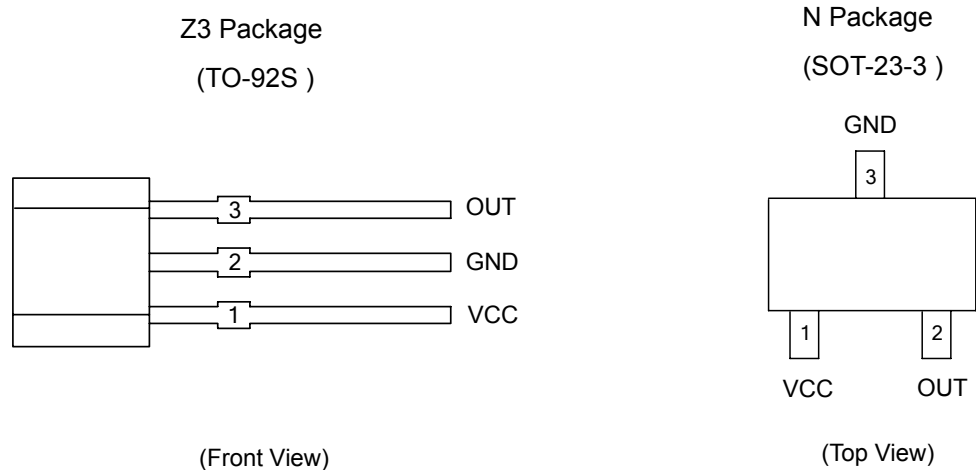

Figure 2. Pin Configuration of AH49E

Pin Description

Pin Number		Pin Name	Function
TO-92S	SOT-23-3		
1	1	VCC	Supply voltage
2	3	GND	Ground pin
3	2	OUT	Output

LINEAR HALL-EFFECT IC

AH49E

Functional Block Diagram

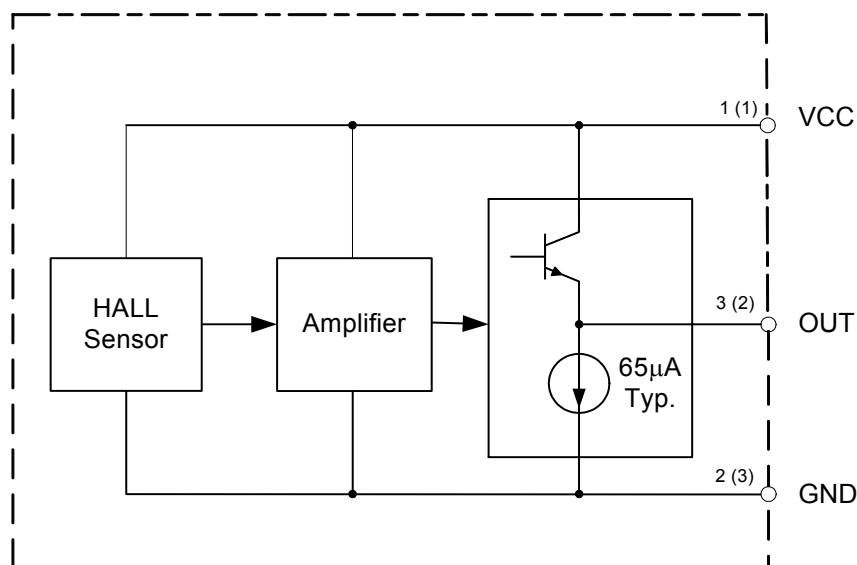

A (B)
A for TO-92S
B for SOT-23-3

Figure 3. Functional Block Diagram of AH49E

Ordering Information

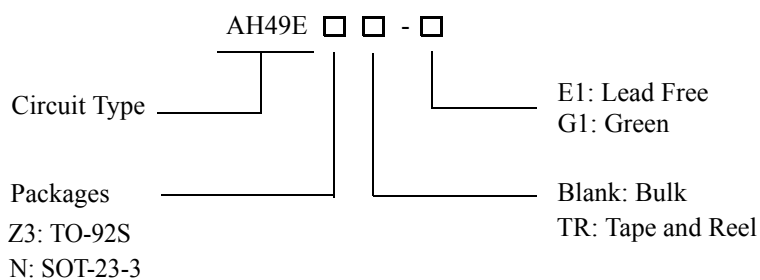

Package	Temperature Range	Part Number		Marking ID		Packing Type
		Lead Free	Green	Lead Free	Green	
TO-92S	-40 to 85°C	AH49EZ3-E1	AH49EZ3-G1	AH49E	AH49G	Bulk
SOT-23-3			AH49ENTR-G1		GJ1	Tape & Reel

BCD Semiconductor's Pb-free products, as designated with "E1" suffix in the part number, are RoHS compliant. Products with "G1" suffix are available in green package.

**LINEAR HALL-EFFECT IC****AH49E****Absolute Maximum Ratings (Note 1)**

Parameter	Symbol	Value	Unit
Supply Voltage	V_{CC}	8	V
Output Current	I_O	10	mA
Operating Temperature	T_A	-40 to 100	°C
Storage Temperature Range	T_{STG}	-50 to 150	°C
ESD (Human Body Model)		3000	V

Note 1: Stresses greater than those listed under "Absolute Maximum Ratings" may cause permanent damage to the device. These are stress ratings only, and functional operation of the device at these or any other conditions beyond those indicated under "Recommended Operating Conditions" is not implied. Exposure to "Absolute Maximum Ratings" for extended periods may affect device reliability.

Recommended Operating Conditions

Parameter	Symbol	Min	Max	Unit
Supply Voltage	V_{CC}	3.0	6.5	V
Operating Temperature	T_{OP}	-40	85	°C

**LINEAR HALL-EFFECT IC****AH49E****Electrical Characteristics**(V_{CC}=5V, T_A=25°C, unless otherwise specified.)

Parameter	Symbol	Conditions	Min	Typ	Max	Unit
Supply Current	I _{CC}			3.5	4.5	mA
Quiescent Output Voltage	V _{NULL}	@ B=0GS	2.25	2.5	2.75	V
Output Voltage Sensitivity		B=0GS to ±1000GS	1.1	1.6	2.1	mV/GS
Output Voltage Span	V _{OS}		1.0 to (V _{CC} -1.0)	0.8 to (V _{CC} -0.8)		V
Output Resistor	R _O			60	120	Ω
Magnetic Field Range	B		±650	±1000		GS
Linearity of Span				0.7		%
Output Noise		BW=10Hz to 10kHz		90		μV

LINEAR HALL-EFFECT IC

AH49E

Transfer Characteristics ($V_{CC}=5V$)

When there is no outside magnetic field ($B=0GS$), the quiescent output voltage is one-half the supply voltage in general.

For TO-92S package, if a south magnetic pole approaches the front face (the side with marking ID) of the Hall effect sensor, the circuit will drive the output voltage higher. Contrary, a north magnetic pole will drive the output voltage lower. The variations of voltage level up or down are symmetrical. Due to SOT-23-3 is reversed packaging with TO-92S, so the magnetic performance is also reversed. Therefore, if the reversed magnetic pole approaches to the front face (the side with marking ID), the output is the same as TO-92S package.

Greatest magnetic sensitivity is obtained with a supply voltage of 6V, but at the cost of increased supply current and a slight loss of output symmetry. So, it is not recommended to work in such condition unless the output voltage magnitude is a main issue. The output signal can be capacitively coupled to an amplifier for

boosting further if the changing frequency of the magnetic field is high.

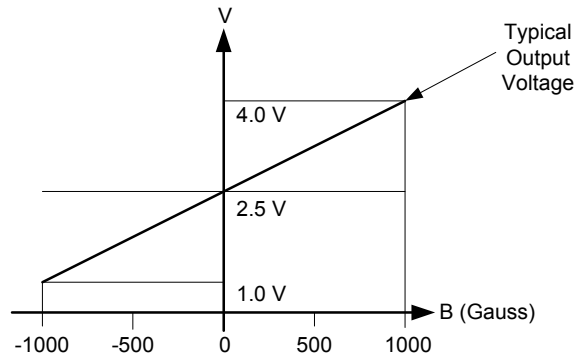
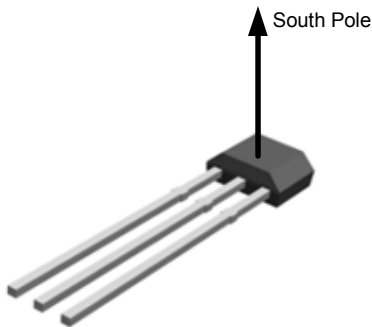
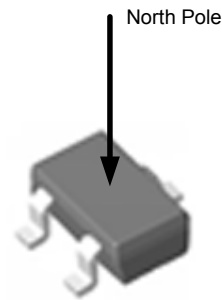

Figure 4. The Transfer Characteristics of AH49E



TO-92S Package



SOT-23-3 Package



Typical Performance Characteristics

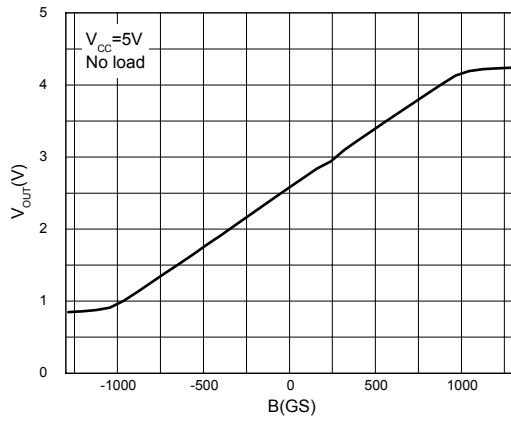

Figure 5. Output Voltage vs. Magnetic Field

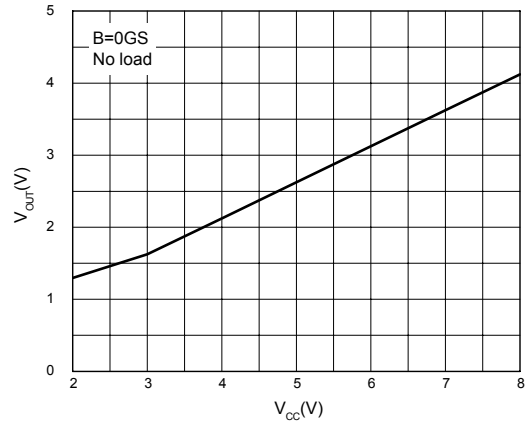

Figure 6. Output Voltage vs. Supply Voltage

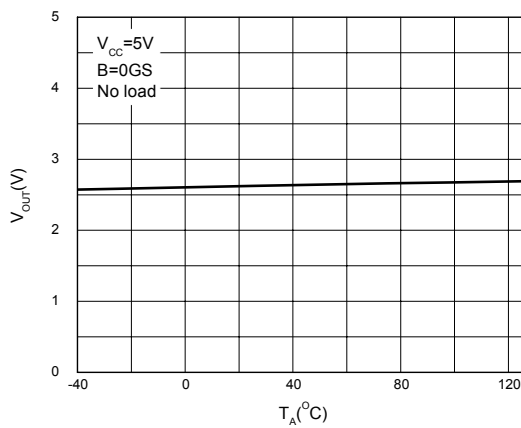

Figure 7. Output Voltage vs. Ambient Temperature



LINEAR HALL-EFFECT IC

AH49E

Mechanical Dimensions

TO-92S

Unit: mm(inch)

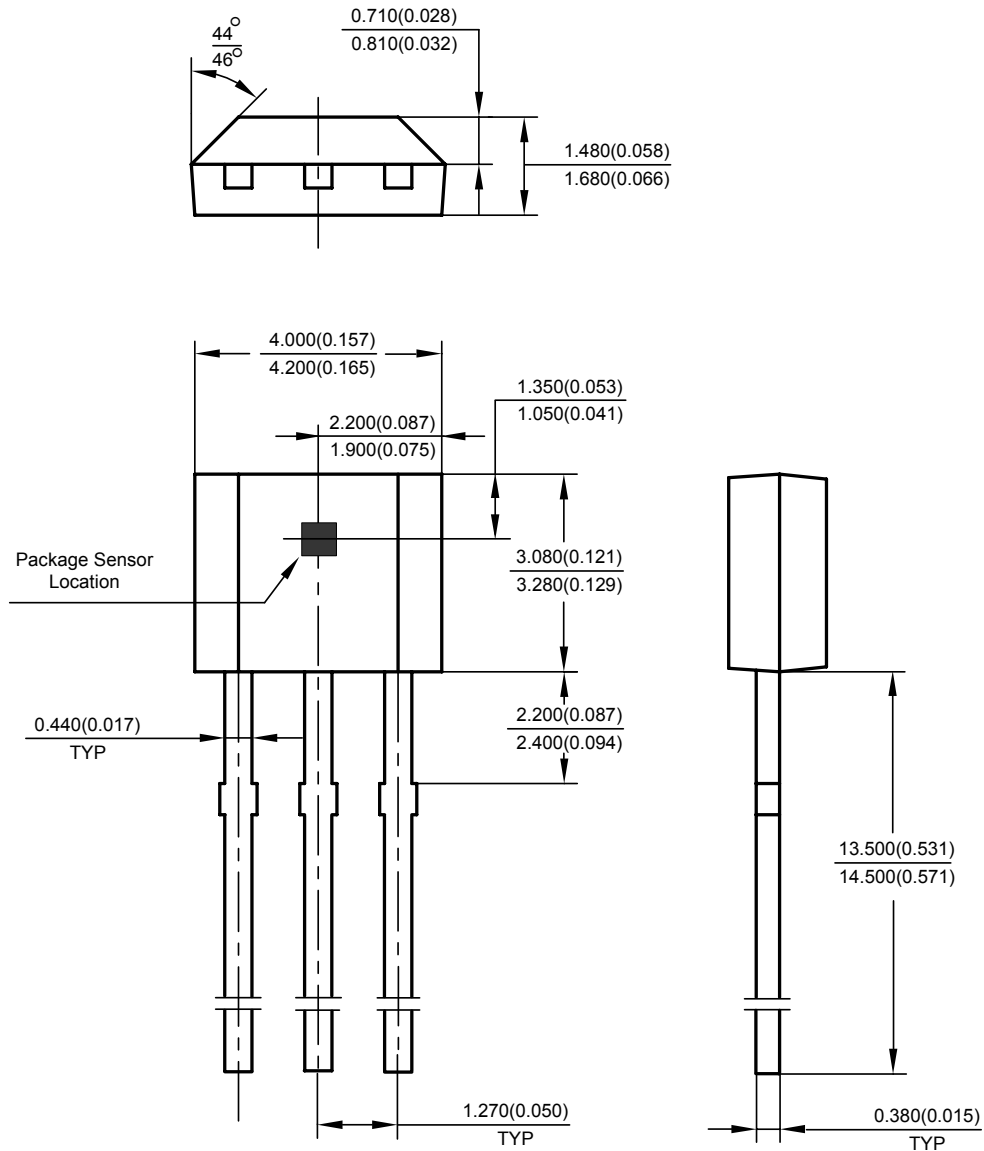



LINEAR HALL-EFFECT IC

AH49E

Mechanical Dimensions (Continued)

SOT-23-3

Unit: mm(inch)

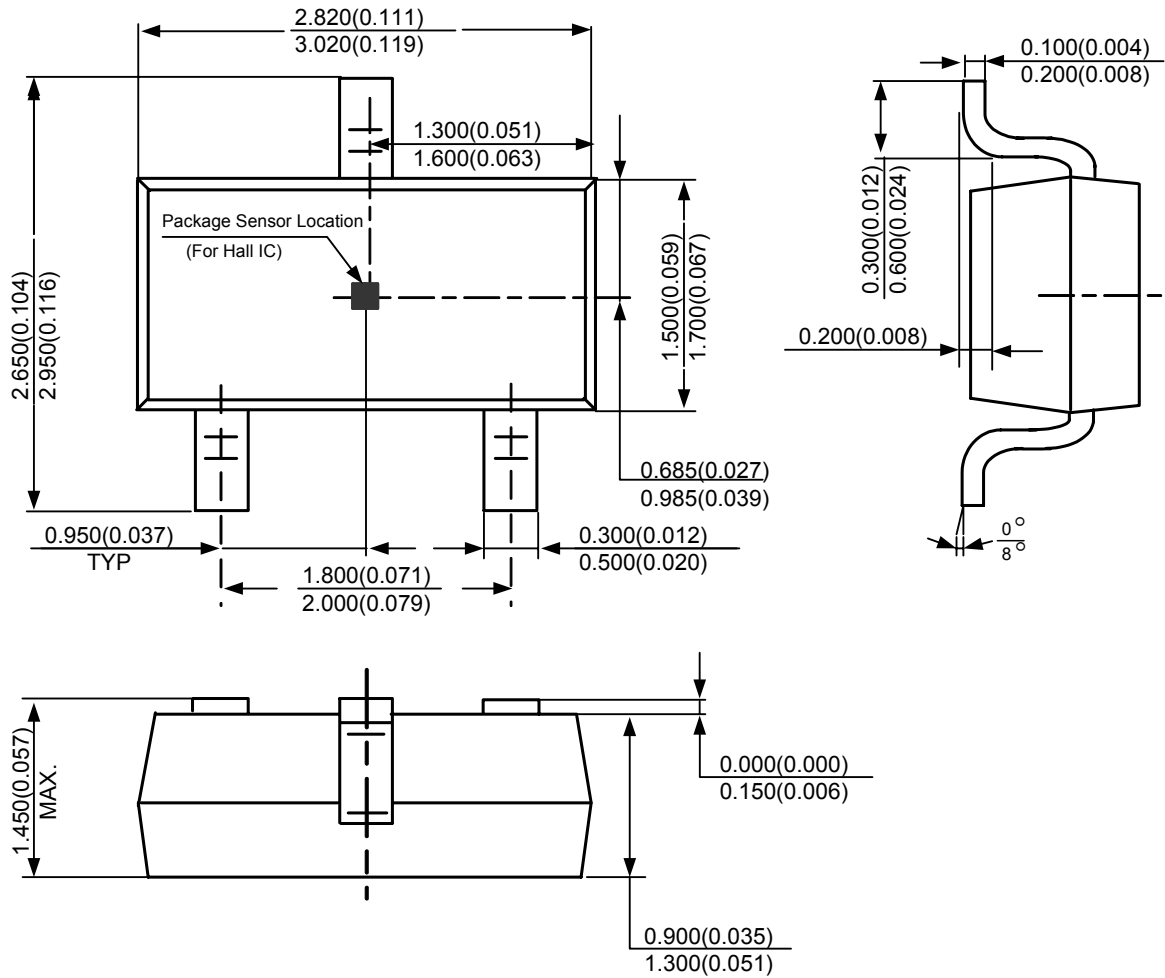



BCD Semiconductor Manufacturing Limited

<http://www.bcdsemi.com>

IMPORTANT NOTICE

BCD Semiconductor Manufacturing Limited reserves the right to make changes without further notice to any products or specifications herein. BCD Semiconductor Manufacturing Limited does not assume any responsibility for use of any its products for any particular purpose, nor does BCD Semiconductor Manufacturing Limited assume any liability arising out of the application or use of any its products or circuits. BCD Semiconductor Manufacturing Limited does not convey any license under its patent rights or other rights nor the rights of others.

MAIN SITE

- Headquarters

BCD Semiconductor Manufacturing Limited

No. 1600, Zi Xing Road, Shanghai Zizhu Science-based Industrial Park, 200241, China
Tel: +86-21-24162266, Fax: +86-21-24162277

- Wafer Fab

Shanghai SIM-BCD Semiconductor Manufacturing Co., Ltd.

800 Yi Shan Road, Shanghai 200233, China
Tel: +86-21-6485 1491, Fax: +86-21-5450 0008

REGIONAL SALES OFFICE

Shenzhen Office

Shanghai SIM-BCD Semiconductor Manufacturing Co., Ltd., Shenzhen Office

Unit A Room 1203, Skyworth Bldg., Gaoxin Ave. 1.S., Nanshan District, Shenzhen, China
Tel: +86-755-8826 7951
Fax: +86-755-8826 7865

Taiwan Office

BCD Semiconductor (Taiwan) Company Limited

4F, 298-1, Rui Guang Road, Nei-Hu District, Taipei, Taiwan
Tel: +886-2-2656 2808
Fax: +886-2-2656 2806



USA Office

BCD Semiconductor Corp.

30920 Huntwood Ave. Hayward, CA 94544, USA
Tel : +1-510-324-2988
Fax: +1-510-324-2788

Looking for pricing, stock, or lifecycle information?

Click below to explore more details on WIN SOURCE:

-  [View AH49EZ3-G1 on WIN SOURCE](#)
-  [Diodes Incorporated Information](#)

Optimize Your Supply Chain with WIN SOURCE Solutions

-  Global Sourcing Solution
-  Obsolete Management
-  Cost Control Management
-  Shortage Management
-  Alternative Solution
-  Excess Inventory Management