



**THE DATASHEET OF
BC857BQ-7-F**



Features

- Ideally Suited for Automatic Insertion
- Complementary NPN Types: BC846 – BC848 Family
- For Switching and AF Amplifier Applications
- **Totally Lead-Free & Fully RoHS Compliant (Notes 1 & 2)**
- **Halogen and Antimony Free. “Green” Device (Note 3)**
- **The BC856AQ – BC857BQ are suitable for automotive applications requiring specific change control; these parts are AEC-Q101 qualified, PPAP capable, and manufactured in IATF 16949 certified facilities.**

<https://www.diodes.com/quality/product-definitions/>

Mechanical Data

- Package: SOT23
- Package Material: Molded Plastic, “Green” Molding Compound. UL Flammability Classification Rating 94V-0
- Moisture Sensitivity: Level 1 per J-STD-020
- Terminals: Finish – Matte Tin Plated Leads, Solderable per MIL-STD-202, Method 208 ③
- Weight: 0.008 grams (Approximate)

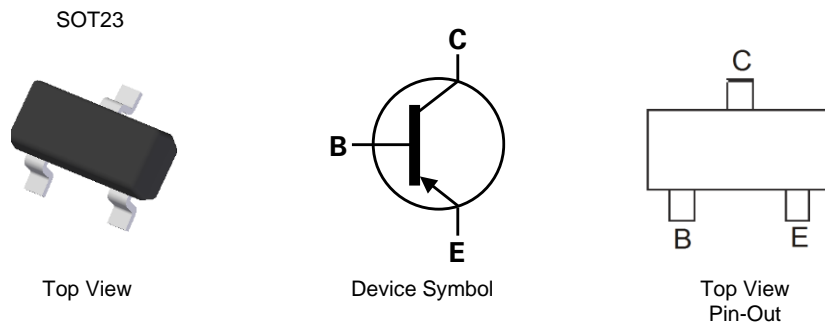

Ordering Information (Note 4)

Part Number	Package	Marking	Reel Size (inches)	Tape Width (mm)	Packing	
					Qty.	Carrier
BC856AQ-7-F	SOT23	K3A	7	8	3,000	Reel
BC856BQ-7-F	SOT23	K3B	7	8	3,000	Reel
BC856BQ-13-F	SOT23	K3B	13	8	10,000	Reel
BC857BQ-7-F	SOT23	K3B	7	8	3,000	Reel

- Notes:
1. No purposely added lead. Fully EU Directive 2002/95/EC (RoHS), 2011/65/EU (RoHS 2) & 2015/863/EU (RoHS 3) compliant.
 2. See <https://www.diodes.com/quality/lead-free/> for more information about Diodes Incorporated's definitions of Halogen- and Antimony-free, "Green" and Lead-free.
 3. Halogen- and Antimony-free "Green" products are defined as those which contain <900ppm bromine, <900ppm chlorine (<1500ppm total Br + Cl) and <1000ppm antimony compounds.
 4. For packaging details, go to our website at <https://www.diodes.com/design/support/packaging/diodes-packaging/>.

Marking Information

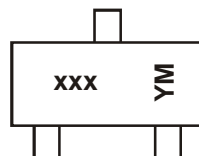

xxx = Product Type Marking Code
(Please see Ordering Information)
YM = Date Code Marking
Y or \bar{Y} = Year (ex: L = 2024)
M or \bar{M} = Month (ex: 9 = September)

Date Code Key

Year	2019	-	2024	2025	2026	2027	2028	2029	2030	2031	2032	2033
Code	G	-	L	M	N	P	R	S	T	U	V	W

Month	Jan	Feb	Mar	Apr	May	Jun	Jul	Aug	Sep	Oct	Nov	Dec
Code	1	2	3	4	5	6	7	8	9	O	N	D

Absolute Maximum Ratings (@T_A = +25°C, unless otherwise specified.)

Characteristic		Symbol	Value	Unit
Collector-Base Voltage	BC856AQ/BQ	V _{CBO}	-80	V
	BC857BQ		-50	
Collector-Emitter Voltage	BC856AQ/BQ	V _{CEO}	-65	V
	BC857BQ		-45	
Emitter-Base Voltage		V _{EBO}	-5.0	V
Continuous Collector Current		I _C	-100	mA
Peak Collector Current		I _{CM}	-200	mA
Peak Emitter Current		I _{EM}	-200	mA
Peak Base Current		I _{BM}	-200	mA

Thermal Characteristics (@T_A = +25°C, unless otherwise specified.)

Characteristic		Symbol	Value	Unit
Power Dissipation	(Note 5)	P _D	310	mW
	(Note 6)		350	
Thermal Resistance, Junction to Ambient	(Note 5)	R _{θJA}	403	°C/W
	(Note 6)		357	
Thermal Resistance, Junction to Leads	(Note 7)	R _{θJL}	350	°C/W
Operating and Storage Temperature Range		T _J , T _{STG}	-65 to +150	°C

ESD Ratings (Note 8)

Characteristic	Symbol	Value	Unit	JEDEC Class
Electrostatic Discharge - Human Body Model	ESD HBM	4,000	V	3A
Electrostatic Discharge - Machine Model	ESD MM	400	V	C

- Notes:
5. For a device mounted on minimum recommended pad layout 1oz copper that is on a single-sided FR-4 PCB; device is measured under still air conditions whilst operating in a steady-state.
 6. Same as note (5), except the device is mounted on 15mm × 15mm 1oz copper.
 7. Thermal resistance from junction to solder-point (at the end of the leads).
 8. Refer to JEDEC specification JESD22-A114 and JESD22-A115.

Thermal Characteristics and Derating Information

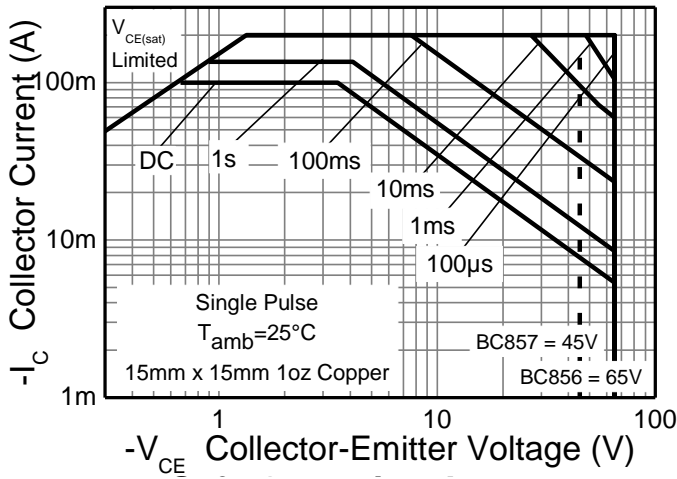

Figure 1. Safe Operating Area

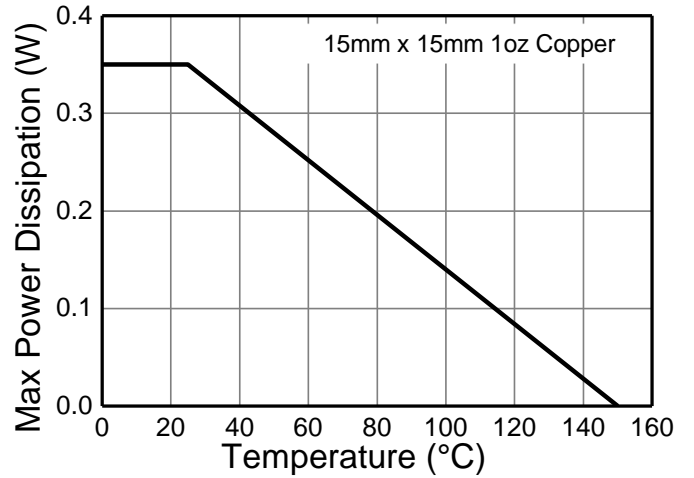

Figure 2. Derating Curve

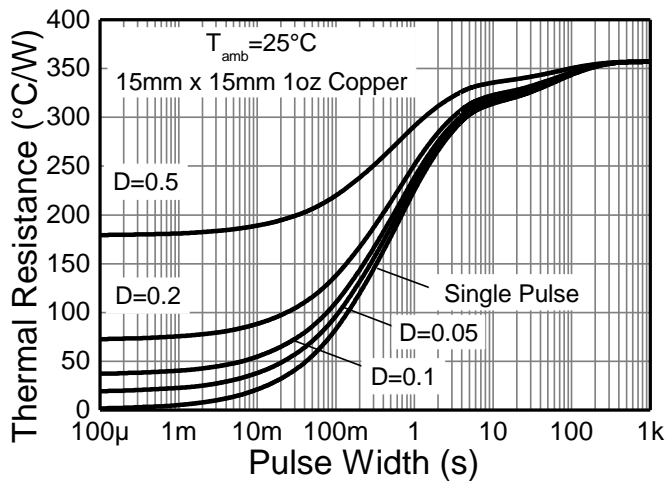

Figure 3. Transient Thermal Impedance

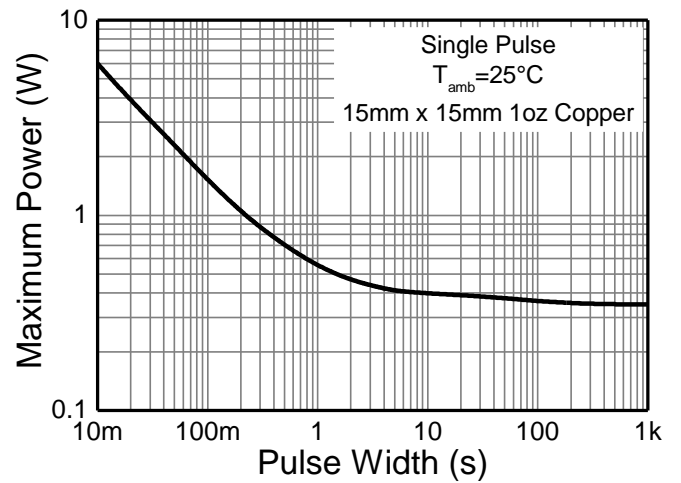

Figure 4. Pulse Power Dissipation

Electrical Characteristics (@T_A = +25°C, unless otherwise specified.)

Characteristic		Symbol	Min	Typ	Max	Unit	Test Condition	
Collector-Base Breakdown Voltage	BC856AQ/BQ	BV _{CB0}	-80	—	—	V	I _C = -10μA	
	BC857BQ		-50					
Collector-Emitter Breakdown Voltage (Note 9)	BC856AQ/BQ	BV _{CEO}	-65	—	—	V	I _C = -10mA	
	BC857BQ		-45					
Emitter-Base Breakdown Voltage		BV _{EBO}	-5	—	—	V	I _E = -1μA	
Collector Cutoff Current		I _{CBO}	—	—	-15	nA	V _{CB} = -30V	
					-4	μA	V _{CB} = -30V, T _J = +150°C	
Collector Emitter Cutoff Current	BC856AQ/BQ	I _{CES}	—	—	-15	nA	V _{CE} = -80V	
	BC857BQ				-15		V _{CE} = -50V	
Emitter-Base Cutoff Current		I _{EBO}	—	—	-100	nA	V _{EB} = -5V	
Small Signal Current Gain	BC856AQ	h _{fe}	—	200	—	—	I _C = -2.0mA, V _{CE} = -5V f = 1.0kHz	
	BC856BQ/BC857BQ			330				
Input Impedance	BC856AQ	h _{ie}	—	2.7	—	kΩ		
	BC856BQ/BC857BQ			4.5				
Output Admittance	BC856AQ	h _{oe}	—	18	—	μS		
	BC856BQ/BC857BQ			30				
Reverse Voltage Transfer Ratio	BC856AQ	h _{re}	—	1.5x10 ⁻⁴	—	—		
	BC856BQ/BC857BQ			2x10 ⁻⁴				
DC Current Gain (Note 9)	BC856AQ	h _{FE}	125	180	250	—		I _C = -2.0mA, V _{CE} = -5V
	BC856BQ/BC857BQ		220	290	475			
Collector-Emitter Saturation Voltage (Note 9)		V _{CE(sat)}	—	-75	-300	mV	I _C = -10mA, I _B = -0.5mA	
				-250	-650		I _C = -100mA, I _B = -5.0mA	
Base-Emitter Turn-On Voltage (Note 9)		V _{BE(on)}	—	-600	-650	mV	I _C = -2mA, V _{CE} = -5V	
				—	-820		I _C = -10mA, V _{CE} = -5V	
Base-Emitter Saturation Voltage (Note 9)		V _{BE(sat)}	—	-700	—	mV	I _C = -10mA, I _B = -0.5mA	
				-850	-1100		I _C = -100mA, I _B = -5mA	
Output Capacitance		C _{obo}	—	3	—	pF	V _{CB} = -10V, f = 1.0MHz	
Transition Frequency		f _T	100	200	—	MHz	V _{CE} = -5V, I _C = -10mA, f = 100MHz	
Noise Figure		NF	—	2	10	dB	V _{CE} = -5V, I _C = -200μA R _S = 2kΩ, f = 1kHz Δf = 200Hz	

Note: 9. Measured under pulsed conditions. Pulse width ≤ 300μs. Duty cycle ≤ 2%.

Typical Electrical Characteristics (@ $T_A = +25^\circ\text{C}$, unless otherwise specified.)

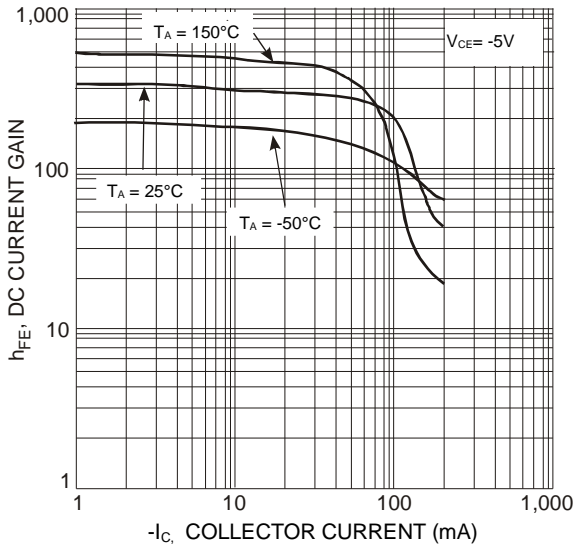

Figure 5. Typical DC Current Gain vs. Collector Current

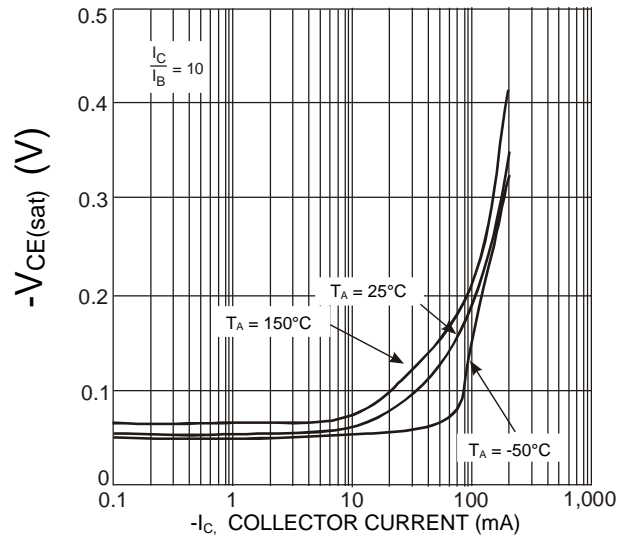

Figure 6. Typical Collector-Emitter Saturation Voltage vs. Collector Current

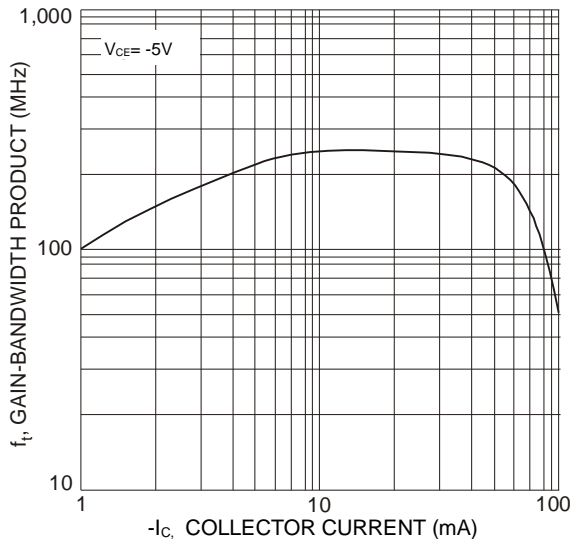
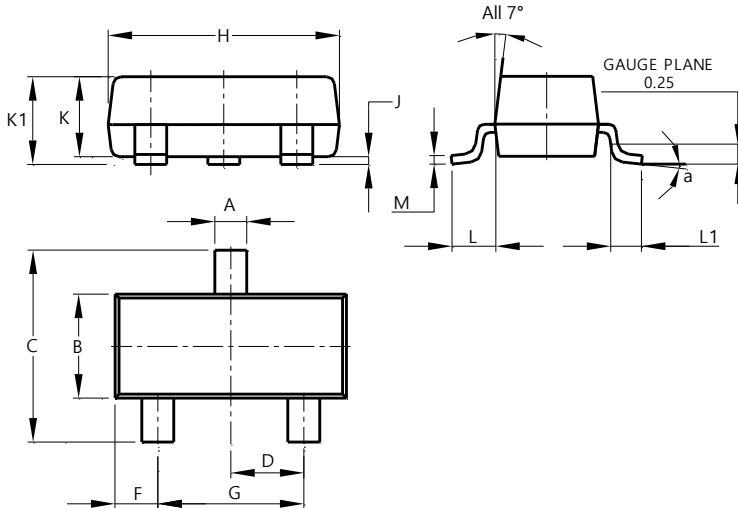

Figure 7. Gain-Bandwidth Product vs. Collector Current

Package Outline Dimensions

Please see <http://www.diodes.com/package-outlines.html> for the latest version.

SOT23



SOT23			
Dim	Min	Max	Typ
A	0.37	0.51	0.40
B	1.20	1.40	1.30
C	2.30	2.50	2.40
D	0.89	1.03	0.915
F	0.45	0.60	0.535
G	1.78	2.05	1.83
H	2.80	3.00	2.90
J	0.013	0.10	0.05
K	0.890	1.00	0.975
K1	0.903	1.10	1.025
L	0.45	0.61	0.55
L1	0.25	0.55	0.40
M	0.085	0.150	0.110
a	0°	8°	--
All Dimensions in mm			

Suggested Pad Layout

Please see <http://www.diodes.com/package-outlines.html> for the latest version.

SOT23

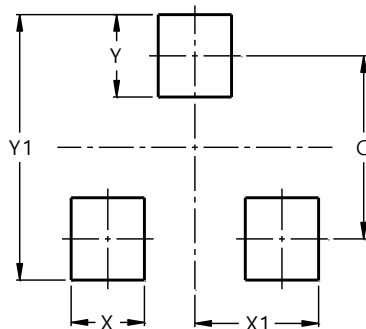

Dimensions	Value (in mm)
C	2.0
X	0.8
X1	1.35
Y	0.9
Y1	2.9

IMPORTANT NOTICE



1. DIODES INCORPORATED (Diodes) AND ITS SUBSIDIARIES MAKE NO WARRANTY OF ANY KIND, EXPRESS OR IMPLIED, WITH REGARDS TO ANY INFORMATION CONTAINED IN THIS DOCUMENT, INCLUDING, BUT NOT LIMITED TO, THE IMPLIED WARRANTIES OF MERCHANTABILITY, FITNESS FOR A PARTICULAR PURPOSE OR NON-INFRINGEMENT OF THIRD PARTY INTELLECTUAL PROPERTY RIGHTS (AND THEIR EQUIVALENTS UNDER THE LAWS OF ANY JURISDICTION).
2. The Information contained herein is for informational purpose only and is provided only to illustrate the operation of Diodes' products described herein and application examples. Diodes does not assume any liability arising out of the application or use of this document or any product described herein. This document is intended for skilled and technically trained engineering customers and users who design with Diodes' products. Diodes' products may be used to facilitate safety-related applications; however, in all instances customers and users are responsible for (a) selecting the appropriate Diodes products for their applications, (b) evaluating the suitability of Diodes' products for their intended applications, (c) ensuring their applications, which incorporate Diodes' products, comply the applicable legal and regulatory requirements as well as safety and functional-safety related standards, and (d) ensuring they design with appropriate safeguards (including testing, validation, quality control techniques, redundancy, malfunction prevention, and appropriate treatment for aging degradation) to minimize the risks associated with their applications.
3. Diodes assumes no liability for any application-related information, support, assistance or feedback that may be provided by Diodes from time to time. Any customer or user of this document or products described herein will assume all risks and liabilities associated with such use, and will hold Diodes and all companies whose products are represented herein or on Diodes' websites, harmless against all damages and liabilities.
4. Products described herein may be covered by one or more United States, international or foreign patents and pending patent applications. Product names and markings noted herein may also be covered by one or more United States, international or foreign trademarks and trademark applications. Diodes does not convey any license under any of its intellectual property rights or the rights of any third parties (including third parties whose products and services may be described in this document or on Diodes' website) under this document.
5. Diodes' products are provided subject to Diodes' Standard Terms and Conditions of Sale (<https://www.diodes.com/about/company/terms-and-conditions/terms-and-conditions-of-sales/>) or other applicable terms. This document does not alter or expand the applicable warranties provided by Diodes. Diodes does not warrant or accept any liability whatsoever in respect of any products purchased through unauthorized sales channel.
6. Diodes' products and technology may not be used for or incorporated into any products or systems whose manufacture, use or sale is prohibited under any applicable laws and regulations. Should customers or users use Diodes' products in contravention of any applicable laws or regulations, or for any unintended or unauthorized application, customers and users will (a) be solely responsible for any damages, losses or penalties arising in connection therewith or as a result thereof, and (b) indemnify and hold Diodes and its representatives and agents harmless against any and all claims, damages, expenses, and attorney fees arising out of, directly or indirectly, any claim relating to any noncompliance with the applicable laws and regulations, as well as any unintended or unauthorized application.
7. While efforts have been made to ensure the information contained in this document is accurate, complete and current, it may contain technical inaccuracies, omissions and typographical errors. Diodes does not warrant that information contained in this document is error-free and Diodes is under no obligation to update or otherwise correct this information. Notwithstanding the foregoing, Diodes reserves the right to make modifications, enhancements, improvements, corrections or other changes without further notice to this document and any product described herein. This document is written in English but may be translated into multiple languages for reference. Only the English version of this document is the final and determinative format released by Diodes.
8. Any unauthorized copying, modification, distribution, transmission, display or other use of this document (or any portion hereof) is prohibited. Diodes assumes no responsibility for any losses incurred by the customers or users or any third parties arising from any such unauthorized use.
9. This Notice may be periodically updated with the most recent version available at <https://www.diodes.com/about/company/terms-and-conditions/important-notice>

The Diodes logo is a registered trademark of Diodes Incorporated in the United States and other countries.
All other trademarks are the property of their respective owners.
© 2024 Diodes Incorporated. All Rights Reserved.

www.diodes.com

Looking for pricing, stock, or lifecycle information?

Click below to explore more details on WIN SOURCE:

-  [View BC857BQ-7-F on WIN SOURCE](#)
-  [Diodes Incorporated Information](#)

Optimize Your Supply Chain with WIN SOURCE Solutions

-  Global Sourcing Solution
-  Obsolete Management
-  Cost Control Management
-  Shortage Management
-  Alternative Solution
-  Excess Inventory Management