



THE DATASHEET OF MAX689CSA



EVALUATION KIT MANUAL
FOLLOWS DATA SHEET

MAXIM

High-Accuracy, Low-Dropout Linear Regulators

MAX687/MAX688/MAX689

General Description

The MAX687/MAX688/MAX689 low-dropout linear regulators operate with an input-to-output voltage differential limited only by an external PNP transistor. Outputs are fixed at 3.3V (MAX687/MAX688) or 3.0V (MAX689). The only external components required are a PNP pass transistor and output, compensation, and bypass capacitors. Base drive to the external transistor is at least 10mA, permitting output currents to exceed 1A when using high-gain transistors ($\beta > 100$). Output current limiting is implemented by limiting the external transistor's base current. Output voltage monitoring and shutdown functions are included.

The 3.3V MAX687 automatically shuts down whenever the output voltage drops below 2.96V. An internal power-fail comparator also monitors the output and provides an early warning of low output voltage before the device shuts down. When shut down, the output is latched off until the ON input is pulsed. Turning off the power supply in this way prevents battery damage due to excessive discharge or cell-reversal. Typical applications include portable telephones and other battery-powered equipment where the power supply must be disabled when the battery voltage is low.

The MAX688 and MAX689 do not have an automatic shutdown function, and are identical except for their output voltages. Each device has an active-low shutdown-control input, used to turn its output on or off at any time. As SHDN falls, the device enters a standby mode before fully shutting down. When in standby, the reference and comparators are fully operational, permitting the transition from normal mode to standby mode to occur at a precise voltage level on SHDN.

Applications

High-Efficiency Linear Regulator
Battery-Powered Devices
Portable Instruments
Portable Telephones
Power Supply or Backup Supply for Memory

Pin Configuration

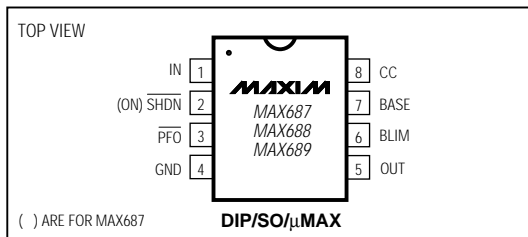

Features

- ♦ **Fixed Outputs:**
 - 3.3V (MAX687/MAX688)
 - 3.0V (MAX689)
- ♦ **Directly Drives External PNP Transistor**
- ♦ **10mA Min Base-Current Drive for >1A Output**
- ♦ **Low Dropout Voltage:**
 - 100mV Dropout at 650mA Output (FZT749)
 - 40mV Dropout at 200mA Output (FZT749)
 - 0.8V Dropout at 4A Output
- ♦ **Power-Fail Output Monitors the Output Voltage**
- ♦ **Automatic, Latched Shutdown when Output Falls Out of Regulation (MAX687)**
- ♦ **Precision Threshold Shutdown Control (MAX688/MAX689)**
- ♦ **Low Supply Current:**
 - 150μA Operating
 - <1μA Shutdown
- ♦ **2.7V to 11.0V Supply Range**
- ♦ **8-Pin DIP/SO/μMAX Packages**
- ♦ **<2mV Line Transient with 3.4V to 3.6V Input**
- ♦ **Output Accuracy $\leq \pm 2\%$**

Ordering Information

PART	TEMP. RANGE	PIN-PACKAGE
MAX687CPA	0°C to +70°C	8 Plastic DIP
MAX687CSA	0°C to +70°C	8 SO
MAX687CUA	0°C to +70°C	8 μMAX
MAX687EPA	-40°C to +85°C	8 Plastic DIP
MAX687ESA	-40°C to +85°C	8 SO

Ordering Information continued at end of data sheet.

Typical Operating Circuit

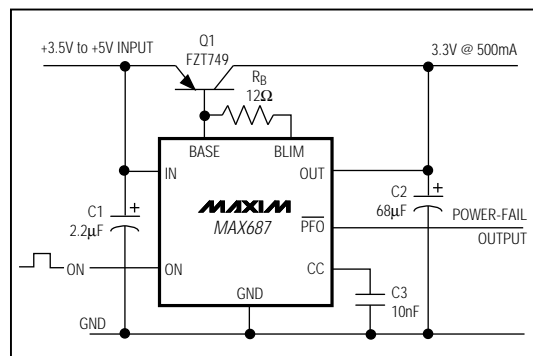

MAXIM

Maxim Integrated Products 1

Call toll free 1-800-998-8800 for free samples or literature.

High-Accuracy, Low-Dropout Linear Regulators

ABSOLUTE MAXIMUM RATINGS

Input Supply Voltage IN to GND	12V	Continuous Power Dissipation (T _A = +70°C)	
Terminal Voltages to GND		Plastic DIP (derate 9.09mW/°C above +70°C)	727mW
PFO (MAX687)	-0.3V to V _{OUT} + 0.3V	SO (derate 5.88mW/°C above +70°C)	471mW
PFO (MAX688/MAX689)	-0.3V to 12V	µMAX (derate 4.1mW/°C above +70°C)	330mW
All Remaining Pins	-0.3V to V _{IN} + 0.3V	Operating Temperature Ranges	
PFO Sink Current	10mA	MAX68_C_A	0°C to +70°C
PFO Source Current (MAX687)	10mA	MAX68_E_A	-40°C to +85°C
		Storage Temperature Range	-65°C to +165°C
		Lead Temperature (soldering, 10sec)	+300°C

Stresses beyond those listed under "Absolute Maximum Ratings" may cause permanent damage to the device. These are stress ratings only, and functional operation of the device at these or any other conditions beyond those indicated in the operational sections of the specifications is not implied. Exposure to absolute maximum rating conditions for extended periods may affect device reliability.

ELECTRICAL CHARACTERISTICS

(V_{IN} = 3.8V, SHDN = V_{IN} (MAX688/MAX689), R_B = 0Ω, C1 = 2.2µF, C2 = 10µF, C3 = 10nF, T_A = T_{MIN} to T_{MAX}, unless otherwise noted. Typical values are at T_A = +25°C.)

PARAMETER	SYMBOL	CONDITIONS	MIN	TYP	MAX	UNITS	
LINEAR REGULATOR							
Supply Voltage	V _{IN}	(Note 1)	2.7		11.0	V	
Output Voltage	V _{OUT}	MAX687/MAX688	V _{IN} = 3.8V, I _{BASE} = 1mA	3.2	3.3	3.4	V
			3.8V ≤ V _{IN} ≤ 11.0V, 1µA ≤ I _{BASE} ≤ 10mA	3.13	3.3	3.47	
		MAX689	V _{IN} = 3.5V, I _{BASE} = 1mA	2.9	3.0	3.1	
			3.5V ≤ V _{IN} ≤ 11.0V, 1µA ≤ I _{BASE} ≤ 10mA	2.85	3.0	3.15	
Dropout Voltage (Note 2)	V _{IN} - V _{OUT}	PNP = FZT749, I _{LOAD} = 200mA, C2 = 20µF		40		mV	
Line Regulation		MAX687/MAX688	3.8V ≤ V _{IN} ≤ 11.0V, I _{BASE} = 1mA	0.4	1.4	mV/V	
		MAX689	3.5V ≤ V _{IN} ≤ 11.0V, I _{BASE} = 1mA	0.4	1.4		
Load Regulation		1µA ≤ I _{BASE} ≤ 10mA		45	60	mV	
Supply Current	I _{GND}	V _{IN} = 3.8V, PNP = FZT749, no load	On		150	250	µA
			Standby, MAX688/MAX689		11	25	
			Shutdown		< 0.02	1	
BASE Sink Current	I _{BASE}	V _{BASE} = V _{IN} - 1V	10	20	40	mA	
Base-Current Limit		R _B is connected from BASE to BLIM (Ω), R _B = 0Ω to 100Ω	$\frac{70}{R_B + 5\Omega}$	$\frac{100}{R_B + 5\Omega}$	$\frac{130}{R_B + 5\Omega}$	mA	
Start-Up Time		(Note 3)		300		µs	
Start-Up Overshoot				2		%	
Load Capacitance	C2	PNP = FZT749, I _{LOAD} = 100mA (Note 4)	10			µF	

High-Accuracy, Low-Dropout Linear Regulators

MAX687/MAX688/MAX689

ELECTRICAL CHARACTERISTICS (continued)

($V_{IN} = 3.8V$, $\overline{SHDN} = V_{IN}$ (MAX688/MAX689), $R_B = 0\Omega$, $C_1 = 2.2\mu F$, $C_2 = 10\mu F$, $C_3 = 10nF$, $T_A = T_{MIN}$ to T_{MAX} , unless otherwise noted. Typical values are at $T_A = +25^\circ C$.)

PARAMETER	SYMBOL	CONDITIONS	MIN	TYP	MAX	UNITS	
MAX687: ON, PFO, SHDN							
\overline{PFO} Threshold Voltage Below V_{NOM} (Note 5)	$V_{NOM} - V_{PFT}$	Falling V_{OUT} , comparators monitor V_{OUT}	110	170		mV	
\overline{PFO} Hysteresis				7		mV	
Shutdown Threshold Voltage Below V_{PFT}	$V_{PFT} - V_{SD}$	Falling V_{OUT} , comparators monitor V_{OUT}	20	70		mV	
Shutdown Threshold Voltage	V_{SD}	Falling V_{OUT} , comparators monitor V_{OUT}	2.96			V	
\overline{PFO} Output Voltage High	V_{OH}	$I_{SOURCE} = 50\mu A$, part on, $V_{IN} = 2.7V$	$V_{OUT} - 0.3$			V	
\overline{PFO} Output Voltage Low	V_{OL}	$I_{SINK} = 1.2mA$, $V_{IN} = 2.7V$		0.06	0.3	V	
ON Threshold Voltage	V_{IH}	Output turns on	1.0			V	
	V_{IL}	Output remains off			0.2		
ON Input Leakage Current				0.2	100	nA	
MAX688/MAX689: SHDN, PFO							
\overline{PFO} Threshold Voltage	V_{PFT}	Falling V_{OUT} , comparators monitor V_{OUT}	MAX688	3.07	3.13	3.19	V
			MAX689	2.77	2.85	2.89	
\overline{PFO} Hysteresis				7		mV	
\overline{SHDN} Threshold Voltages	V_{SON}	On, \overline{SHDN} falling	1.25			V	
	V_{SSY}	Standby	1.0		1.2		
	V_{SSD}	Shutdown			0.2		
\overline{SHDN} Hysteresis		Rising \overline{SHDN} , standby→on		70		mV	
\overline{SHDN} Input Current		$V_{\overline{SHDN}} = 1.23V$	-25		25	nA	
\overline{PFO} , \overline{SHDN} Transient Rejection		Glitch immunity		100		μs	
\overline{PFO} Output Voltage Low	V_{OL}	$I_{SINK} = 1.2mA$, $V_{IN} = 2.7V$		0.06	0.3	V	
\overline{PFO} Off Leakage Current		$V_{\overline{PFO}} = 11V$, $V_{\overline{SHDN}} > 1.25V$			1	μA	
Output Noise Voltage	e_n	$10Hz \leq f \leq 10kHz$, $I_{LOAD} = 200mA$		66		μV_{RMS}	
		$10Hz \leq f \leq 1MHz$, $I_{LOAD} = 200mA$		105			

Note 1: Minimum V_{IN} for regulated V_{OUT} depends on the characteristics of the external PNP transistor, and on the load. The reference and comparators are functional down to the minimum voltage specified, but the output may not be in regulation.

Note 2: Dropout voltage is defined as $V_{IN} - V_{OUT}$ when V_{OUT} is 50mV below its value at $V_{IN} = V_{NOM} + 1V$.

Note 3: The start-up time specification is the time taken from ON or SHDN rising to BASE sinking current. V_{OUT} rise time is longer and is a function of load capacitance, C_2 , and load resistance, R_L .

Note 4: Minimum load capacitance is a function of R_L . Minimum $C_2 = 10\mu F$ for loads up to 100mA and $1\mu F/10mA$ for higher loads. ESR of C_2 should be no larger than 1/100 of R_L . Guaranteed by design.

Note 5: The nominal output voltage, V_{NOM} , is defined under the default conditions of testing: $V_{IN} = 3.8V$, $I_{BASE} = 1mA$, $T_A = T_{MIN}$ to T_{MAX} .

High-Accuracy, Low-Dropout Linear Regulators

Typical Operating Characteristics

(Circuits of Figures 1 and 2, $V_{IN} = 5V$, $Q1 = FZT749$, $T_A = +25^\circ C$, unless otherwise noted.)

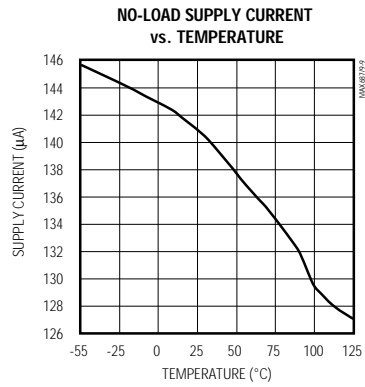
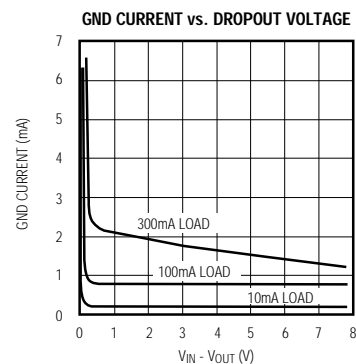
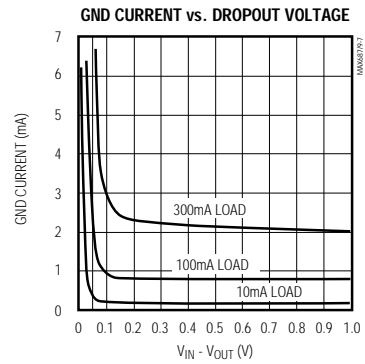
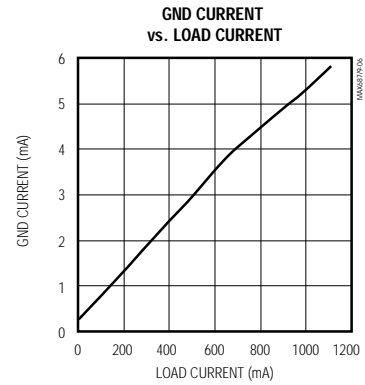
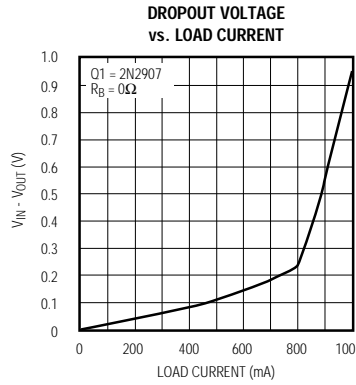
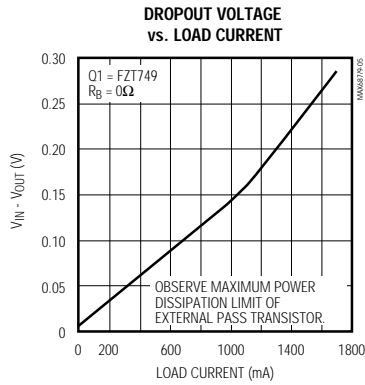
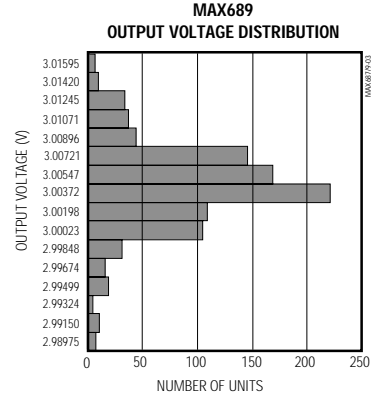
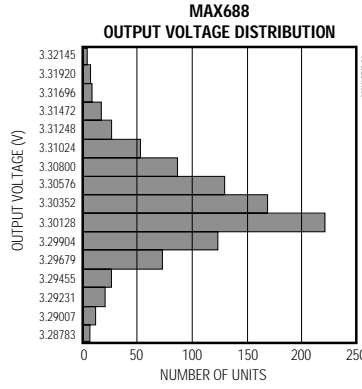
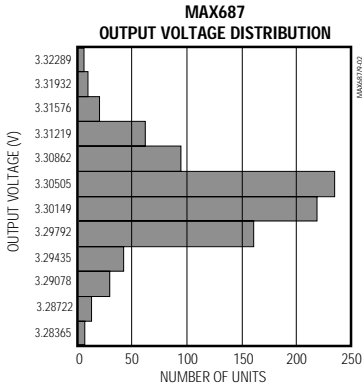

High-Accuracy, Low-Dropout Linear Regulators

Typical Operating Characteristics (continued)

(Circuits of Figures 1 and 2, $V_{IN} = 5V$, Q1 = FZT749, $T_A = +25^\circ C$, unless otherwise noted.)

MAX687/MAX688/MAX689

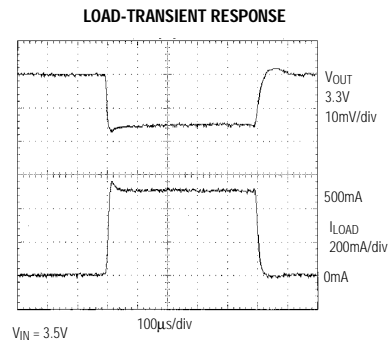
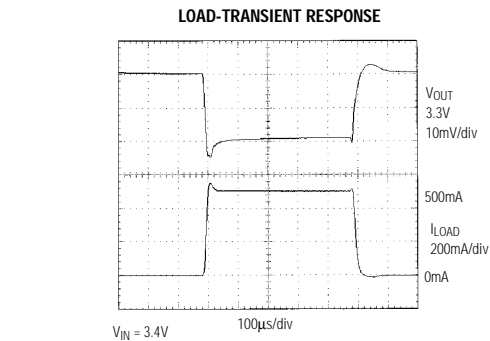
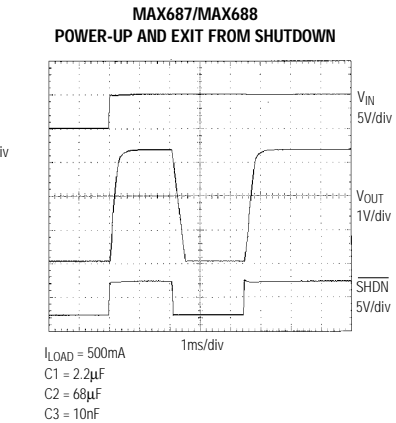
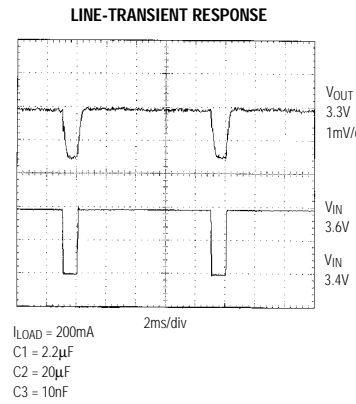
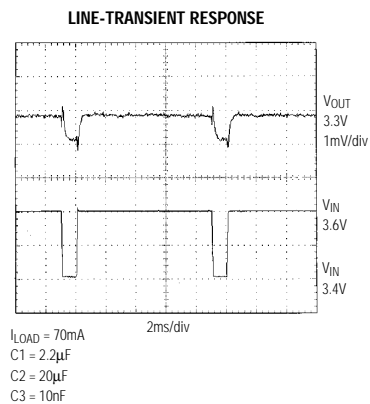
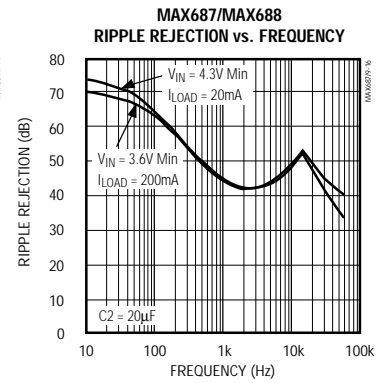
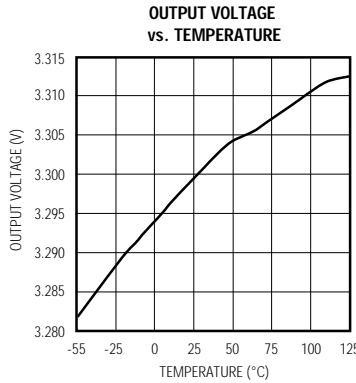
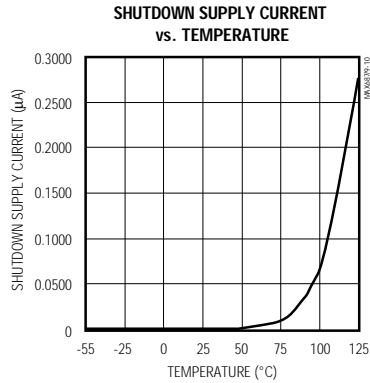

High-Accuracy, Low-Dropout Linear Regulators

Pin Description

PIN	NAME	FUNCTION
1	IN	Positive input voltage, 2.7V to 11.0V
2	ON (MAX687)	ON activates the regulator when pulsed high. In order for the regulator to remain on, ON must remain high until V_{OUT} exceeds the internal shutdown threshold voltage. The MAX687 is shut down when $V_{OUT} < 2.96V$, and remains latched off until ON is pulsed high. When powered up, the MAX687 does not start up until ON is pulsed high. Connect to V_{IN} if not used.
	\overline{SHDN} (MAX688/ MAX689)	\overline{SHDN} is a three-level input that controls the mode of operation. The device is on when $V_{\overline{SHDN}} > 1.25V$. The output is disabled and the supply current is reduced ($I_{IN} < 25\mu A$, standby mode) when $V_{\overline{SHDN}} < 1.2V$, and is fully off ($I_{IN} < 1\mu A$, shutdown mode) when $V_{\overline{SHDN}} < 0.2V$. Connect \overline{SHDN} to IN if the shutdown function is not used. \overline{PFO} is low when \overline{SHDN} is low (below 0.2V).
3	\overline{PFO}	Power-Fail Output. \overline{PFO} trips when V_{OUT} is 170mV below nominal V_{OUT} at $I_{BASE} = 1mA$. \overline{PFO} sources and sinks current in the MAX687, but is an open drain in the MAX688/MAX689. When shut down, \overline{PFO} is always low and sinks current. Leave \overline{PFO} open if not used.
4	GND	Ground
5	OUT	Regulator Output. MAX687/MAX688, 3.3V; MAX689, 3.0V.
6	BLIM	Base current limit. A resistor (R_B) connected between BASE and BLIM sets the maximum base drive to the PNP transistor: $I_{BASE} \leq 0.1V / (R_B + 5\Omega)$. This limits quiescent current rise during dropout and also provides current limiting without using a current-sense resistor in the collector of the external PNP, thus not impacting dropout. Output current limiting accuracy depends on how well the external PNP beta (h_{FE}) is controlled. Connect to BASE if not used.
7	BASE	Base drive for the external PNP transistor. Current limiting is controlled using a resistor (R_B) connected between BASE and BLIM. For maximum output current, connect BASE to BLIM.
8	CC	Compensation Capacitor. Connect a non-polarized capacitor (10nF to 100nF) from CC to GND.

Detailed Description

The MAX687/MAX688/MAX689 are precision low-dropout linear regulators employing external PNP transistors to achieve a wide range of output currents at voltages of 3.0V or 3.3V. The maximum base current for the PNP can be limited using a resistor. Limiting the base drive keeps high currents from being wasted when the device is in dropout (e.g., at low input voltages), and limits the regulator's output current. The dropout voltage is limited only by the PNP transistor's $V_{CE(SAT)}$. The Power-Fail Output (\overline{PFO}) goes low when the output voltage drops 170mV below the nominal level.

The three devices differ in their output voltages, in their shutdown-control functions, and in \overline{PFO} 's output drive (see Table 1).

Table 1. Device Functions

FUNCTION	MAX687	MAX688	MAX689
V_{OUT}	3.3V	3.3V	3.0V
Shutdown Control	Automatic at low V_{OUT} . Latched. Use ON to start.	External \overline{SHDN}	External \overline{SHDN}
\overline{PFO}	Sources & Sinks	Open Drain	Open Drain

The MAX687's output voltage is internally monitored; a falling V_{OUT} is signaled by \overline{PFO} going low. As the output falls further, the MAX687 automatically enters a low-power shutdown mode, where the base drive to the external PNP is cut off. \overline{PFO} trips at a minimum of 110mV below the nominal V_{OUT} , and shutdown occurs by 2.96V. \overline{PFO} is guaranteed to trip before the device

High-Accuracy, Low-Dropout Linear Regulators

MAX687/MAX688/MAX689

shuts down. Once the MAX687 is shut down, it can only be turned on again when (a) the ON pin is pulsed high, and (b) the conditions that triggered shutdown have changed (e.g., the load has been reduced or the input voltage has increased). In order for the MAX687 to latch into its on state, the ON pulse must remain high until the output voltage has risen above the shutdown threshold. The internal shutdown can be used to prevent deep discharge of a battery, for example, to provide "self backup" of CMOS RAM or to protect the battery itself.

The RC circuit attached to the ON input in Figure 1 achieves automatic start-up at power-on by delivering a brief pulse whenever the input voltage is suddenly applied. This circuit is not suitable for applications where the input voltage rises slowly. The RC values should be chosen to keep ON high until the output rises above about 3.13V. The values shown in Figure 1 for C4 and R1 (0.1µF and 10kΩ) are suitable for most applications. To ensure start-up when the input voltage is very close to the circuit's dropout voltage, when the circuit is used to drive a very large capacitive load, or for high-power circuits ($I_{LOAD} > 3A$), increase the value of R1 to increase the ON pulse width.

The 3.3V MAX688 and the 3.0V MAX689 incorporate the same PFO warning whenever V_{OUT} droops. However, the MAX688/MAX689 do not automatically shut down when the output voltage drops even further. Instead, the SHDN input controls external shutdown. As SHDN is pulled low, the chip first enters a low-current standby state ($<25\mu A$). The threshold at which standby mode is entered is precisely controlled ($\pm 2\%$) so the output can be turned off at a well-defined point.

70mV of hysteresis between the standby and on states prevents chatter between the two modes. The voltage applied to the SHDN pin can be derived from a resistive divider from V_{IN} . When V_{SHDN} is less than 1.2V, the output is off. The device is fully shut down ($<1\mu A$) when SHDN is pulled below 200mV. SHDN is not latched, and as SHDN is raised, the MAX688/MAX689 exit shutdown and enter the standby mode. At the higher SHDN threshold, the output is turned on.

Figure 1 shows a typical circuit for the MAX687, and Figure 2 shows the same circuit configured for the MAX688/MAX689.

The accuracy of the output current limit depends on accurate knowledge of the PNP pass transistor's current gain (h_{FE}). With $R_B = 12\Omega$, BLIM limits base current to 6mA ($I_{BASE} = 0.1V / (R_B + 5\Omega)$). See *Base-Current Limiting* section.

The PFO comparators on all three devices, and the internal shutdown comparator on the MAX687, reject high-speed spikes ($<100\mu s$). This reduces the PFO output's noise sensitivity, and stops the MAX687 from being shut down inadvertently when there is noise on the input supply.

Transistor Selection

Specifications

The PNP pass transistor must meet specifications for

- current gain,
- power dissipation, and
- collector current.

The h_{FE} influences the maximum output current the circuit can deliver. The largest guaranteed output current

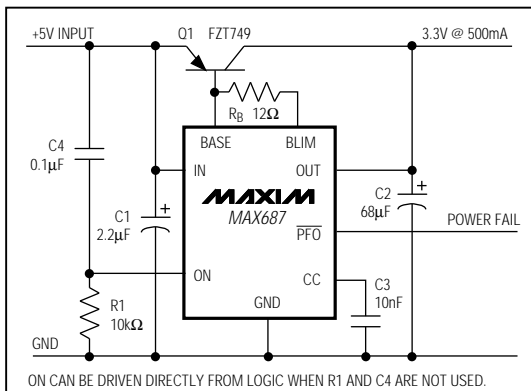

Figure 1. MAX687 Operating Circuit

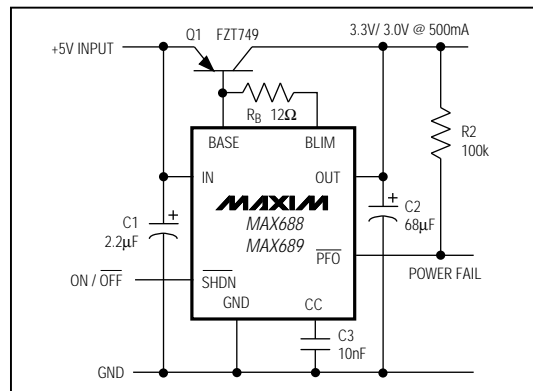

Figure 2. MAX688/MAX689 Operating Circuit

High-Accuracy, Low-Dropout Linear Regulators

is given by $I_{LOAD(MAX)} = 10mA \times h_{FE(MIN)}$. The transistor's rated power dissipation must exceed the actual power dissipated in the transistor. The power dissipated (PD) equals the maximum load current ($I_{LOAD(MAX)}$) times the maximum input to output voltage differential: $PD = I_{LOAD(MAX)} \times (V_{IN(MAX)} - V_{OUT})$. The rated transistor collector current must exceed the maximum load current. Suitable transistors include the Zetex FZT749, and the 2N2907A (see Table 2).

Base-Current Limiting

A comparator monitors the voltage across the external base-current-limiting resistor (between BASE and BLIM). This sets the maximum base current. If BASE and BLIM are shorted, base current is limited nominally to 20mA due to an internal 5Ω resistor in series with the external resistance. Choose the base-current-limiting resistor, R_B , so the drop across it at rated load is approximately 50mV.

$$R_B = \frac{(50mV) \times h_{FE(MIN)}}{I_{LOAD(MAX)}} - 5\Omega$$

The base drive is controlled so the voltage on BLIM is limited to 100mV below the voltage on BASE; with a 50mV nominal drop across $R_B + 5\Omega$, base-current drive is limited to twice the nominal. This limits base current when the external PNP is heavily saturated, such as when the regulator is in dropout due to low input voltage. In addition, if the external PNP's h_{FE} is defined within reasonable limits, base-current control effectively limits output current without a dropout voltage penalty.

Capacitor Selection

Bypass Capacitor (C1)

Connect a bypass capacitor from IN to GND. $4.7\mu F$ makes the circuit insensitive to layout, and is sufficient for any load. Smaller values may be used—down to $0.33\mu F$ —with low-ESR capacitors, good board layout, and a low-impedance incoming supply.

Connect the bypass capacitor directly between pins 1 and 4 of the IC, using short leads. Connect the emitter of the PNP transistor directly to the bypass capacitor using a very short trace.

Output Capacitor (C2)

The output filter capacitor must be at least $10\mu F$. For currents above 100mA, use $1\mu F$ of capacitance for every 10mA of load current (e.g., $20\mu F$ for 200mA load, $50\mu F$ for 500mA). Low-ESR capacitors give best stability and transient response. Ensure that the capacitor's ESR is less than 1% of the load resistance. See Table 2 for a list of manufacturers. Sanyo OS-CON capacitors are recommended for applications operating at temperatures below $0^\circ C$.

Compensation Capacitor (C3)

Connect a compensation capacitor from CC to GND. $10nF$ is recommended, although higher values (up to $100nF$) may also be used. Higher C3 values eliminate power-on overshoot, but extend power-up times. Current flowing into or out of CC causes the regulator's reference voltage to change, resulting in shifted output voltage and trip thresholds. Use non-polarized capacitors (e.g., ceramic, polyester, etc.) to keep leakage currents below 25nA. Aluminum and tantalum electrolytic capacitors are unsuitable because of their high leakage currents.

Power-Fail Output

The \overline{PFO} output trips when V_{OUT} is 170mV below nominal V_{OUT} at $I_{BASE} = 1mA$. \overline{PFO} sources and sinks current in the MAX687, but is an open drain in the MAX688/MAX689 and only sinks current. When shut down, \overline{PFO} is always low regardless of the voltage at OUT. Leave \overline{PFO} open if it is not used.

High-Accuracy, Low-Dropout Linear Regulators

Applications Information

High-Power Output Circuit

Figure 3 shows a pseudo-Darlington transistor configuration to increase load-current capability and maintain a low dropout voltage with a 4A load. A heatsink must be added when high power is dissipated in the pass transistor.

Figure 4 shows the ($V_{IN} - V_{OUT}$) voltage required to maintain regulation for different load currents. Figure 5 shows an oscilloscope plot of the transient response of a 200mA to 4A load step.

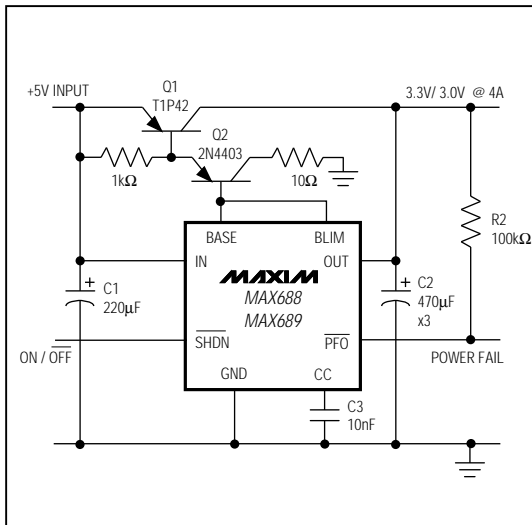

Figure 3. 4A Low-Dropout Circuit

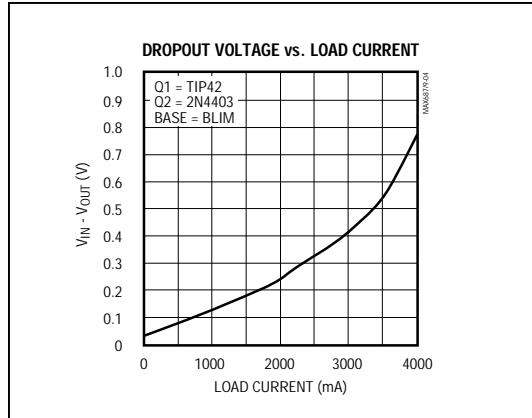

Figure 4. Dropout Voltage vs. Load Current of Figure 3

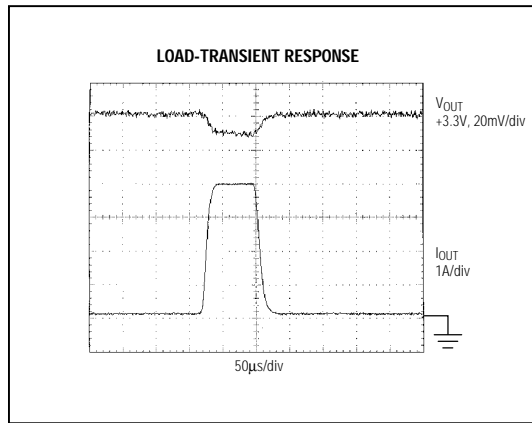

Figure 5. Transient Response for a 200mA to 4A Load Step Using Circuit of Figure 3

MAX687/MAX688/MAX689

High-Accuracy, Low-Dropout Linear Regulators

MAX687/MAX688/MAX689

Table 2a. Component Suppliers

DEVICE	MANUFACTURER	PRODUCTION METHOD
CAPACITORS		
267 series	Matsuo	Surface Mount
F95 Tantalum series	Nichicon	
595 Tantalum series	Sprague	
OS-CON series low-ESR organic semiconductor	Sanyo	Through-Hole
LXF series	United Chemi-Con	
BIPOLAR TRANSISTORS		
ZTX749	Zetex	Through-Hole
T1P42	Motorola	
2N4403	Motorola	
2N2907A	Motorola	
CMPT2907A	Central Semiconductor	Surface Mount
PZT2907AT1	Motorola	
FZT749	Zetex	

**Table 2b. Manufacturers' Phone
and Fax Numbers**

MANU-FACTURER	COUNTRY	TELEPHONE	FAX
Central Semiconductor	USA	(516) 435-1110	(516) 435-1824
Matsuo	USA	(714) 969-2491	(714) 960-6492
Motorola	USA	(602) 244-3370	(602) 244-4015
Nichicon	USA	(708) 843-7500	(708) 843-2798
	Japan	+81-7-5231-8461	+81-7-5256-4158
Sanyo	USA	(619) 661-6835	(619) 661-1055
	Japan	+81-7-2070-6306	+81-7-2070-1174
Sprague	USA	(603) 224-1961	(603) 224-1430
United Chemi-Con	USA	(714) 255-9500	(714) 255-9400
Zetex	USA	(516) 543-7100	(516) 864-7630
	UK	+44-61-627-5105	+44-61-627-5467

High-Accuracy, Low-Dropout Linear Regulators

_Ordering Information (continued)

PART	TEMP. RANGE	PIN-PACKAGE
MAX688 CPA	0°C to +70°C	8 Plastic DIP
MAX688CSA	0°C to +70°C	8 SO
MAX688CUA	0°C to +70°C	8 μ MAX
MAX688EPA	-40°C to +85°C	8 Plastic DIP
MAX688ESA	-40°C to +85°C	8 SO
MAX689 CPA	0°C to +70°C	8 Plastic DIP
MAX689CSA	0°C to +70°C	8 SO
MAX689CUA	0°C to +70°C	8 μ MAX
MAX689EPA	-40°C to +85°C	8 Plastic DIP
MAX689ESA	-40°C to +85°C	8 SO

MAX687/MAX688/MAX689

High-Accuracy, Low-Dropout Linear Regulators

Package Information

MAX687/MAX688/MAX689

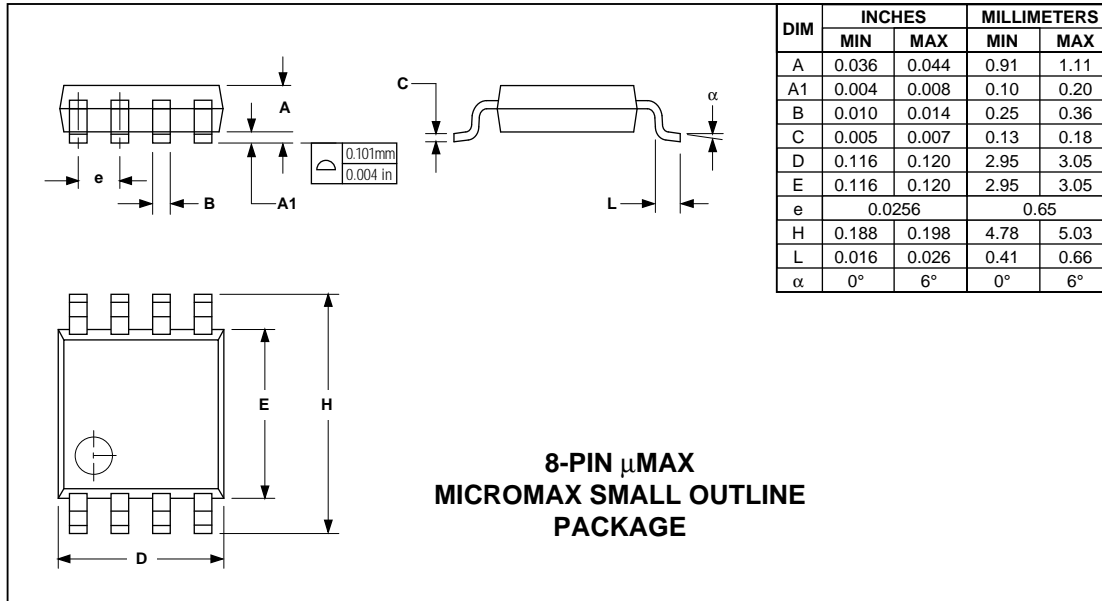

Maxim cannot assume responsibility for use of any circuitry other than circuitry entirely embodied in a Maxim product. No circuit patent licenses are implied. Maxim reserves the right to change the circuitry and specifications without notice at any time.

12 _____ Maxim Integrated Products, 120 San Gabriel Drive, Sunnyvale, CA 94086 (408) 737-7600

© 1994 Maxim Integrated Products

Printed USA

MAXIM is a registered trademark of Maxim Integrated Products.

Looking for pricing, stock, or lifecycle information?

Click below to explore more details on WIN SOURCE:

- ⊖ [View MAX689CSA](#) on WIN SOURCE
- ⊖ [Maxim Integrated](#) Information

Optimize Your Supply Chain with WIN SOURCE Solutions

- ✓ Global Sourcing Solution
- ✓ Obsolete Management
- ✓ Cost Control Management
- ✓ Shortage Management
- ✓ Alternative Solution
- ✓ Excess Inventory Management