



**THE DATASHEET OF  
NCP1117DT18RK**



# 1.0 A Low-Dropout Positive Fixed and Adjustable Voltage Regulators



SOT-223  
ST SUFFIX  
CASE 318H



DPAK  
DT SUFFIX  
CASE 369C

## NCP1117, NCP1117I, NCV1117

The NCP1117 series are low dropout positive voltage regulators that are capable of providing an output current that is in excess of 1.0 A with a maximum dropout voltage of 1.2 V at 800 mA over temperature. This series contains nine fixed output voltages of 1.5 V, 1.8 V, 1.9 V, 2.0 V, 2.5 V, 2.85 V, 3.3 V, 5.0 V, and 12 V that have no minimum load requirement to maintain regulation. Also included is an adjustable output version that can be programmed from 1.25 V to 18.8 V with two external resistors. On chip trimming adjusts the reference/output voltage to within  $\pm 1.0\%$  accuracy. Internal protection features consist of output current limiting, safe operating area compensation, and thermal shutdown. The NCP1117 series can operate with up to 20 V input. Devices are available in SOT-223 and DPAK packages.

### Features

- Output Current in Excess of 1.0 A
- 1.2 V Maximum Dropout Voltage at 800 mA Over Temperature
- Fixed Output Voltages of 1.5 V, 1.8 V, 1.9 V, 2.0 V, 2.5 V, 2.85 V, 3.3 V, 5.0 V, and 12 V
- Adjustable Output Voltage Option
- No Minimum Load Requirement for Fixed Voltage Output Devices
- Reference/Output Voltage Trimmed to  $\pm 1.0\%$
- Current Limit, Safe Operating and Thermal Shutdown Protection
- Operation to 20 V Input
- NCV Prefix for Automotive and Other Applications Requiring Unique Site and Control Change Requirements; AEC-Q100 Qualified and PPAP Capable
- These are Pb-Free Devices

### Applications

- Consumer and Industrial Equipment Point of Regulation
- Active SCSI Termination for 2.85 V Version
- Switching Power Supply Post Regulation
- Hard Drive Controllers
- Battery Chargers

### PIN CONFIGURATION

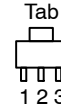

SOT-223  
(Top View)

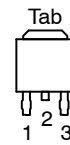

DPAK  
(Top View)

- Pin: 1. Adjust/Ground  
 2. Output  
 3. Input

Heatsink tab is connected to Pin 2.

### ORDERING INFORMATION

See detailed ordering and shipping information in the package dimensions section on page 12 of this data sheet.

### DEVICE MARKING INFORMATION

See general marking information in the device marking section on page 14 of this data sheet.

# NCP1117, NCP1117I, NCV1117

## TYPICAL APPLICATIONS



**Figure 1. Fixed Output Regulator**



**Figure 2. Adjustable Output Regulator**



**Figure 3. Active SCSI Bus Terminator**

### MAXIMUM RATINGS

Rating	Symbol	Value	Unit
Input Voltage (Note 1)	$V_{in}$	20	V
Output Short Circuit Duration (Notes 2 and 3)	–	Infinite	–
Power Dissipation and Thermal Characteristics			
Case 318H (SOT–223)			
Power Dissipation (Note 2)	$P_D$	Internally Limited	W
Thermal Resistance, Junction–to–Ambient, Minimum Size Pad	$R_{\theta JA}$	160	$^{\circ}C/W$
Thermal Resistance, Junction–to–Case	$R_{\theta JC}$	15	$^{\circ}C/W$
Case 369A (DPAK)			
Power Dissipation (Note 2)	$P_D$	Internally Limited	W
Thermal Resistance, Junction–to–Ambient, Minimum Size Pad	$R_{\theta JA}$	67	$^{\circ}C/W$
Thermal Resistance, Junction–to–Case	$R_{\theta JC}$	6.0	$^{\circ}C/W$
Maximum Die Junction Temperature Range	$T_J$	–55 to 150	$^{\circ}C$
Storage Temperature Range	$T_{stg}$	–65 to 150	$^{\circ}C$
Operating Ambient Temperature Range	$T_A$		$^{\circ}C$
NCP1117		0 to +125	
NCP1117I		–40 to +125	
NCV1117		–40 to +125	

Stresses exceeding those listed in the Maximum Ratings table may damage the device. If any of these limits are exceeded, device functionality should not be assumed, damage may occur and reliability may be affected.

1. This device series contains ESD protection and exceeds the following tests:

Human Body Model (HBM), Class 2, 2000 V  
Machine Model (MM), Class B, 200 V  
Charge Device Model (CDM), Class IV, 2000 V.

2. Internal thermal shutdown protection limits the die temperature to approximately 175 $^{\circ}C$ . Proper heatsinking is required to prevent activation.

The maximum package power dissipation is:

$$P_D = \frac{T_{J(max)} - T_A}{R_{\theta JA}}$$

3. The regulator output current must not exceed 1.0 A with  $V_{in}$  greater than 12 V.

# NCP1117, NCP1117I, NCV1117

## ELECTRICAL CHARACTERISTICS

( $C_{in} = 10 \mu\text{F}$ ,  $C_{out} = 10 \mu\text{F}$ , for typical value  $T_A = 25^\circ\text{C}$ , for min and max values  $T_A$  is the operating ambient temperature range that applies unless otherwise noted.) (Note 4)

Characteristic	Symbol	Min	Typ	Max	Unit
Reference Voltage, Adjustable Output Devices ( $V_{in}-V_{out} = 2.0 \text{ V}$ , $I_{out} = 10 \text{ mA}$ , $T_A = 25^\circ\text{C}$ ) ( $V_{in}-V_{out} = 1.4 \text{ V to } 10 \text{ V}$ , $I_{out} = 10 \text{ mA to } 800 \text{ mA}$ ) (Note 4)	$V_{ref}$	1.238 1.225	1.25 –	1.262 1.270	V
Output Voltage, Fixed Output Devices 1.5 V ( $V_{in} = 3.5 \text{ V}$ , $I_{out} = 10 \text{ mA}$ , $T_A = 25^\circ\text{C}$ ) ( $V_{in} = 2.9 \text{ V to } 11.5 \text{ V}$ , $I_{out} = 0 \text{ mA to } 800 \text{ mA}$ ) (Note 4)  1.8 V ( $V_{in} = 3.8 \text{ V}$ , $I_{out} = 10 \text{ mA}$ , $T_A = 25^\circ\text{C}$ ) ( $V_{in} = 3.2 \text{ V to } 11.8 \text{ V}$ , $I_{out} = 0 \text{ mA to } 800 \text{ mA}$ ) (Note 4)  1.9 V ( $V_{in} = 3.9 \text{ V}$ , $I_{out} = 10 \text{ mA}$ , $T_A = 25^\circ\text{C}$ ) ( $V_{in} = 3.3 \text{ V to } 11.9 \text{ V}$ , $I_{out} = 0 \text{ mA to } 800 \text{ mA}$ ) (Note 4)  2.0 V ( $V_{in} = 4.0 \text{ V}$ , $I_{out} = 10 \text{ mA}$ , $T_A = 25^\circ\text{C}$ ) ( $V_{in} = 3.4 \text{ V to } 12 \text{ V}$ , $I_{out} = 0 \text{ mA to } 800 \text{ mA}$ ) (Note 4)  2.5 V ( $V_{in} = 4.5 \text{ V}$ , $I_{out} = 10 \text{ mA}$ , $T_A = 25^\circ\text{C}$ ) ( $V_{in} = 3.9 \text{ V to } 10 \text{ V}$ , $I_{out} = 0 \text{ mA to } 800 \text{ mA}$ ,) (Note 4)  2.85 V ( $V_{in} = 4.85 \text{ V}$ , $I_{out} = 10 \text{ mA}$ , $T_A = 25^\circ\text{C}$ ) ( $V_{in} = 4.25 \text{ V to } 10 \text{ V}$ , $I_{out} = 0 \text{ mA to } 800 \text{ mA}$ ) (Note 4) ( $V_{in} = 4.0 \text{ V}$ , $I_{out} = 0 \text{ mA to } 500 \text{ mA}$ ) (Note 4)  3.3 V ( $V_{in} = 5.3 \text{ V}$ , $I_{out} = 10 \text{ mA}$ , $T_A = 25^\circ\text{C}$ ) ( $V_{in} = 4.75 \text{ V to } 10 \text{ V}$ , $I_{out} = 0 \text{ mA to } 800 \text{ mA}$ ) (Note 4)  5.0 V ( $V_{in} = 7.0 \text{ V}$ , $I_{out} = 10 \text{ mA}$ , $T_A = 25^\circ\text{C}$ ) ( $V_{in} = 6.5 \text{ V to } 12 \text{ V}$ , $I_{out} = 0 \text{ mA to } 800 \text{ mA}$ ) (Note 4)  12 V ( $V_{in} = 14 \text{ V}$ , $I_{out} = 10 \text{ mA}$ , $T_A = 25^\circ\text{C}$ ) ( $V_{in} = 13.5 \text{ V to } 20 \text{ V}$ , $I_{out} = 0 \text{ mA to } 800 \text{ mA}$ ) (Note 4)	$V_{out}$	1.485 1.470  1.782 1.755  1.872 1.862  1.970 1.960  2.475 2.450  2.821 2.790 2.790  3.267 3.235  4.950 4.900  11.880 11.760	1.500 –  1.800 –  1.900 1.900  2.000 –  2.500 –  2.850 – –  3.300 –  5.000 –  12.000 –	1.515 1.530  1.818 1.845  1.929 1.938  2.030 2.040  2.525 2.550  2.879 2.910 2.910  3.333 3.365  5.050 5.100  12.120 12.240	V
Line Regulation (Note 5) Adjustable ( $V_{in} = 2.75 \text{ V to } 16.25 \text{ V}$ , $I_{out} = 10 \text{ mA}$ )  1.5 V ( $V_{in} = 2.9 \text{ V to } 11.5 \text{ V}$ , $I_{out} = 0 \text{ mA}$ ) 1.8 V ( $V_{in} = 3.2 \text{ V to } 11.8 \text{ V}$ , $I_{out} = 0 \text{ mA}$ ) 1.9 V ( $V_{in} = 3.3 \text{ V to } 11.9 \text{ V}$ , $I_{out} = 0 \text{ mA}$ ) 2.0 V ( $V_{in} = 3.4 \text{ V to } 12 \text{ V}$ , $I_{out} = 0 \text{ mA}$ ) 2.5 V ( $V_{in} = 3.9 \text{ V to } 10 \text{ V}$ , $I_{out} = 0 \text{ mA}$ ) 2.85 V ( $V_{in} = 4.25 \text{ V to } 10 \text{ V}$ , $I_{out} = 0 \text{ mA}$ ) 3.3 V ( $V_{in} = 4.75 \text{ V to } 15 \text{ V}$ , $I_{out} = 0 \text{ mA}$ ) 5.0 V ( $V_{in} = 6.5 \text{ V to } 15 \text{ V}$ , $I_{out} = 0 \text{ mA}$ ) 12 V ( $V_{in} = 13.5 \text{ V to } 20 \text{ V}$ , $I_{out} = 0 \text{ mA}$ )	$Reg_{line}$	– – – – – – – – – –	0.04 0.3 0.4 0.5 0.5 0.8 0.8 0.9 1.0	0.1 1.0 1.0 2.5 2.5 3.0 4.5 6.0 7.5	% mV
Load Regulation (Note 5) Adjustable ( $I_{out} = 10 \text{ mA to } 800 \text{ mA}$ , $V_{in} = 4.25 \text{ V}$ )  1.5 V ( $I_{out} = 0 \text{ mA to } 800 \text{ mA}$ , $V_{in} = 2.9 \text{ V}$ ) 1.8 V ( $I_{out} = 0 \text{ mA to } 800 \text{ mA}$ , $V_{in} = 3.2 \text{ V}$ ) 1.9 V ( $I_{out} = 0 \text{ mA to } 800 \text{ mA}$ , $V_{in} = 3.3 \text{ V}$ ) 2.0 V ( $I_{out} = 0 \text{ mA to } 800 \text{ mA}$ , $V_{in} = 3.4 \text{ V}$ ) 2.5 V ( $I_{out} = 0 \text{ mA to } 800 \text{ mA}$ , $V_{in} = 3.9 \text{ V}$ ) 2.85 V ( $I_{out} = 0 \text{ mA to } 800 \text{ mA}$ , $V_{in} = 4.25 \text{ V}$ ) 3.3 V ( $I_{out} = 0 \text{ mA to } 800 \text{ mA}$ , $V_{in} = 4.75 \text{ V}$ ) 5.0 V ( $I_{out} = 0 \text{ mA to } 800 \text{ mA}$ , $V_{in} = 6.5 \text{ V}$ ) 12 V ( $I_{out} = 0 \text{ mA to } 800 \text{ mA}$ , $V_{in} = 13.5 \text{ V}$ )	$Reg_{line}$	– – – – – – – – – –	0.2 2.3 2.6 2.7 3.0 3.3 3.8 4.3 6.7 16	0.4 5.5 6.0 6.0 6.0 7.5 8.0 10 15 28	% mV
Dropout Voltage (Measured at $V_{out} - 100 \text{ mV}$ ) ( $I_{out} = 100 \text{ mA}$ ) ( $I_{out} = 500 \text{ mA}$ ) ( $I_{out} = 800 \text{ mA}$ )	$V_{in}-V_{out}$	– – –	0.95 1.01 1.07	1.10 1.15 1.20	V
Output Current Limit ( $V_{in}-V_{out} = 5.0 \text{ V}$ , $T_A = 25^\circ\text{C}$ , Note 6)	$I_{out}$	1000	1500	2200	mA
Minimum Required Load Current for Regulation, Adjustable Output Devices ( $V_{in} = 15 \text{ V}$ )	$I_{L(min)}$	–	0.8	5.0	mA

# NCP1117, NCP1117I, NCV1117

## ELECTRICAL CHARACTERISTICS (continued)

( $C_{in} = 10 \mu\text{F}$ ,  $C_{out} = 10 \mu\text{F}$ , for typical value  $T_A = 25^\circ\text{C}$ , for min and max values  $T_A$  is the operating ambient temperature range that applies unless otherwise noted.) (Note 4)

Characteristic	Symbol	Min	Typ	Max	Unit
Quiescent Current 1.5 V ( $V_{in} = 11.5 \text{ V}$ ) 1.8 V ( $V_{in} = 11.8 \text{ V}$ ) 1.9 V ( $V_{in} = 11.9 \text{ V}$ ) 2.0 V ( $V_{in} = 12 \text{ V}$ ) 2.5 V ( $V_{in} = 10 \text{ V}$ ) 2.85 V ( $V_{in} = 10 \text{ V}$ ) 3.3 V ( $V_{in} = 15 \text{ V}$ ) 5.0 V ( $V_{in} = 15 \text{ V}$ ) 12 V ( $V_{in} = 20 \text{ V}$ )	$I_Q$	–	3.6 4.2 4.3 4.5 5.2 5.5 6.0 6.0 6.0	10 10 10 10 10 10 10 10 10	mA
Thermal Regulation ( $T_A = 25^\circ\text{C}$ , 30 ms Pulse)		–	0.01	0.1	%/W
Ripple Rejection ( $V_{in}-V_{out} = 6.4 \text{ V}$ , $I_{out} = 500 \text{ mA}$ , 10 $V_{pp}$ 120 Hz Sinewave) Adjustable 1.5 V 1.8 V 1.9 V 2.0 V 2.5 V 2.85 V 3.3 V 5.0 V 12 V	RR	67 66 66 66 64 62 62 60 57 50	73 72 70 72 70 68 68 64 61 54	– – – – – – – – – –	dB
Adjustment Pin Current ( $V_{in} = 11.25 \text{ V}$ , $I_{out} = 800 \text{ mA}$ )	$I_{adj}$	–	52	120	$\mu\text{A}$
Adjust Pin Current Change ( $V_{in}-V_{out} = 1.4 \text{ V}$ to 10 V, $I_{out} = 10 \text{ mA}$ to 800 mA)	$\Delta I_{adj}$	–	0.4	5.0	$\mu\text{A}$
Temperature Stability	$S_T$	–	0.5	–	%
Long Term Stability ( $T_A = 25^\circ\text{C}$ , 1000 Hrs End Point Measurement)	$S_t$	–	0.3	–	%
RMS Output Noise ( $f = 10 \text{ Hz}$ to 10 kHz)	N	–	0.003	–	% $V_{out}$

Product parametric performance is indicated in the Electrical Characteristics for the listed test conditions, unless otherwise noted. Product performance may not be indicated by the Electrical Characteristics if operated under different conditions.

4. NCP1117:  $T_{low} = 0^\circ\text{C}$ ,  $T_{high} = 125^\circ\text{C}$

NCP1117I:  $T_{low} = -40^\circ\text{C}$ ,  $T_{high} = 125^\circ\text{C}$

NCV1117:  $T_{low} = -40^\circ\text{C}$ ,  $T_{high} = 125^\circ\text{C}$

5. Low duty cycle pulse techniques are used during testing to maintain the junction temperature as close to ambient as possible.

6. The regulator output current must not exceed 1.0 A with  $V_{in}$  greater than 12 V.

# NCP1117, NCP1117I, NCV1117



**Figure 4. Output Voltage Change vs. Temperature**

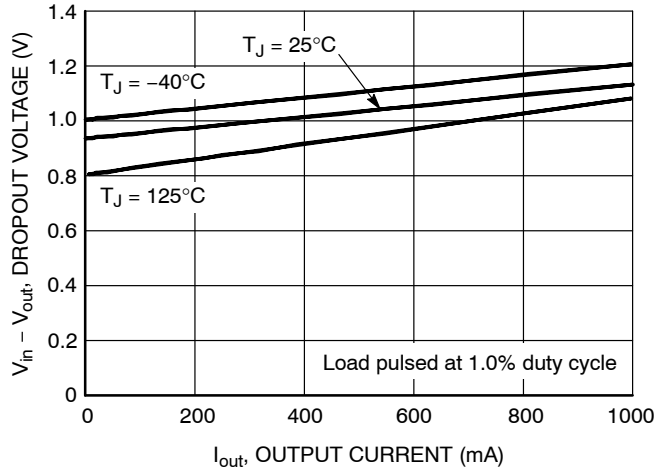

**Figure 5. Dropout Voltage vs. Output Current**



**Figure 6. Output Short Circuit Current vs. Differential Voltage**



**Figure 7. Output Short Circuit Current vs. Temperature**

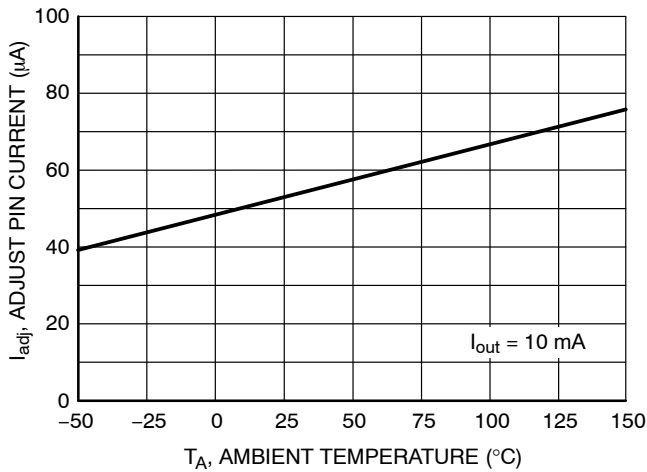

**Figure 8. Adjust Pin Current vs. Temperature**

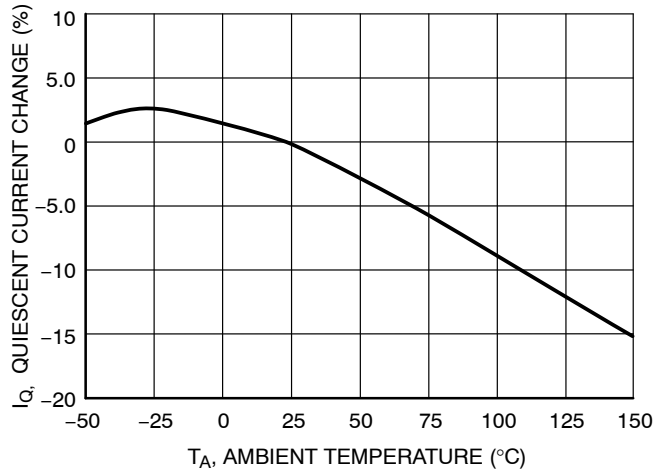

**Figure 9. Quiescent Current Change vs. Temperature**

# NCP1117, NCP1117I, NCV1117



**Figure 10. NCP1117XTA Ripple Rejection vs. Output Current**



**Figure 11. NCP1117XTA Ripple Rejection vs. Frequency**



**Figure 12. Output Capacitance vs. ESR**



**Figure 13. Typical ESR vs. Output Current**

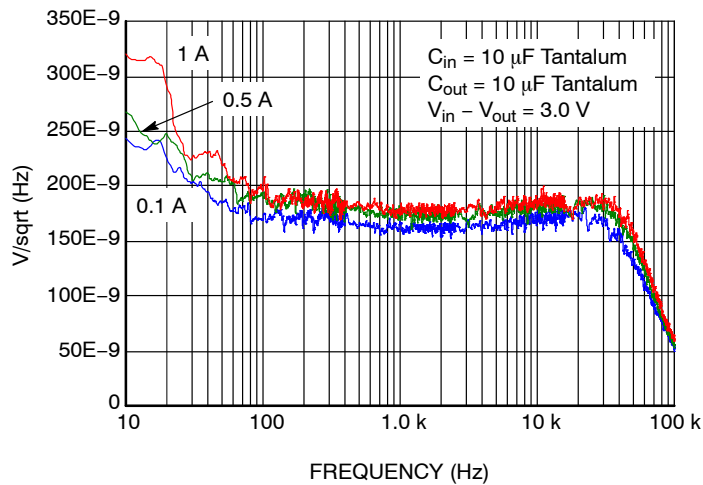

**Figure 14. Output Spectral Noise Density vs. Frequency,  $V_{out} = 1V5$**

# NCP1117, NCP1117I, NCV1117



**Figure 15. NCP1117XT285  
Line Transient Response**



**Figure 16. NCP1117XT285  
Load Transient Response**

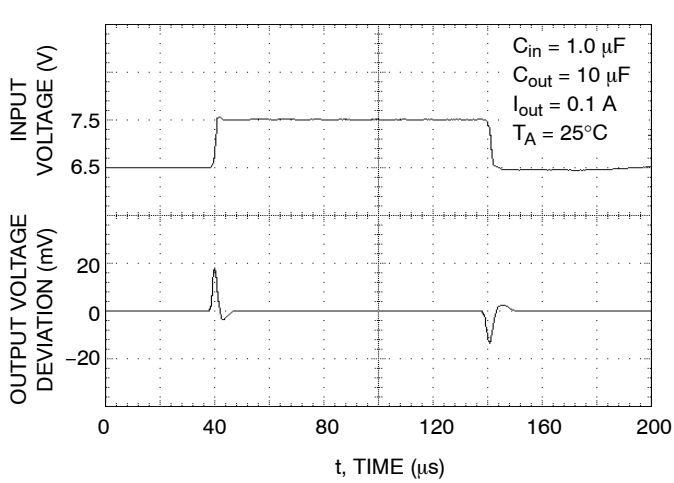

**Figure 17. NCP1117XT50  
Line Transient Response**

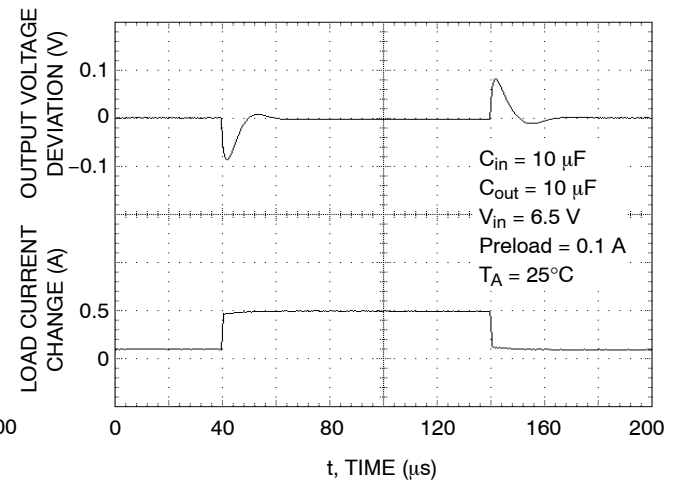

**Figure 18. NCP1117XT50  
Load Transient Response**

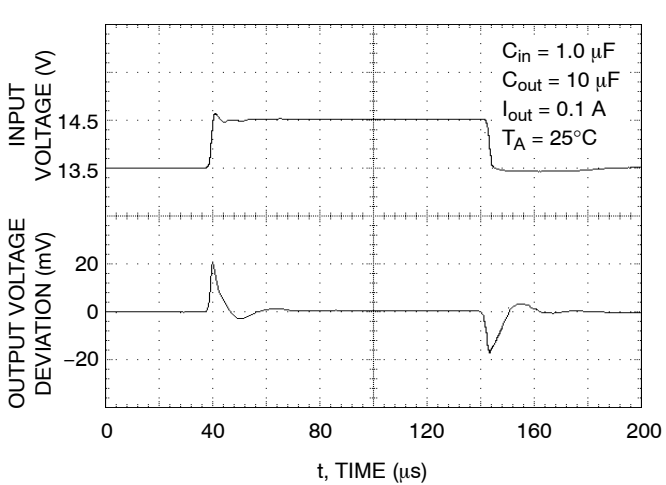

**Figure 19. NCP1117XT12 Line  
Transient Response**

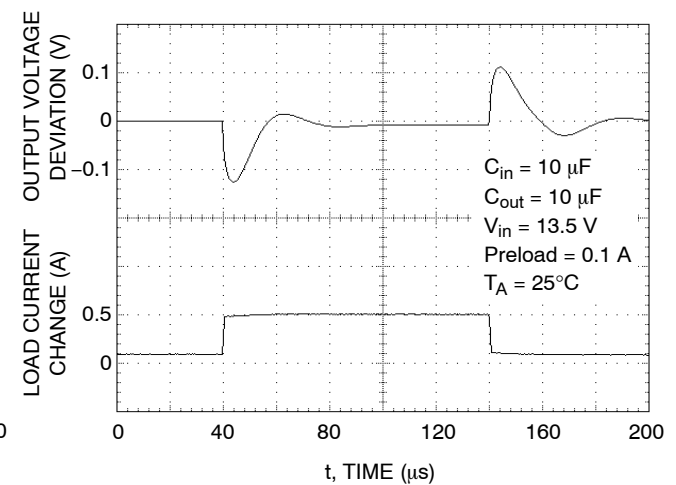

**Figure 20. NCP1117XT12 Load  
Transient Response**

NCP1117, NCP1117I, NCV1117



Figure 21. SOT-223 Thermal Resistance and Maximum Power Dissipation vs. P.C.B. Copper Length



Figure 22. DPAK Thermal Resistance and Maximum Power Dissipation vs. P.C.B. Copper Length

APPLICATIONS INFORMATION

Introduction

The NCP1117 features a significant reduction in dropout voltage along with enhanced output voltage accuracy and temperature stability when compared to older industry standard three-terminal adjustable regulators. These devices contain output current limiting, safe operating area compensation and thermal shutdown protection making them designer friendly for powering numerous consumer and industrial products. The NCP1117 series is pin compatible with the older LM317 and its derivative device types.

Output Voltage

The typical application circuits for the fixed and adjustable output regulators are shown in Figures 23 and 24. The adjustable devices are floating voltage regulators. They develop and maintain the nominal 1.25 V reference voltage between the output and adjust pins. The reference voltage is programmed to a constant current source by resistor R1, and this current flows through R2 to ground to set the output voltage. The programmed current level is usually selected to be greater than the specified 5.0 mA minimum that is required for regulation. Since the adjust pin current,  $I_{adj}$ , is significantly lower and constant with respect to the programmed load current, it generates a small output voltage error that can usually be ignored. For the fixed output devices R1 and R2 are included within the device and the ground current  $I_{gnd}$ , ranges from 3.0 mA to 5.0 mA depending upon the output voltage.

External Capacitors

Input bypass capacitor  $C_{in}$  may be required for regulator stability if the device is located more than a few inches from the power source. This capacitor will reduce the circuit's sensitivity when powered from a complex source impedance and significantly enhance the output transient response. The input bypass capacitor should be mounted with the shortest possible track length directly across the regulator's input and ground terminals. A 10  $\mu$ F ceramic or tantalum capacitor should be adequate for most applications.



Figure 23. Fixed Output Regulator

Frequency compensation for the regulator is provided by capacitor  $C_{out}$  and its use is mandatory to ensure output stability. A minimum capacitance value of 4.7  $\mu$ F with an equivalent series resistance (ESR) that is within the limits of 33 m $\Omega$  (typ) to 2.2  $\Omega$  is required. See Figures 12 and 13. The capacitor type can be ceramic, tantalum, or aluminum electrolytic as long as it meets the minimum capacitance value and ESR limits over the circuit's entire operating temperature range. Higher values of output capacitance can be used to enhance loop stability and transient response with the additional benefit of reducing output noise.



$$V_{out} = V_{ref} \left( 1 + \frac{R_2}{R_1} \right) + I_{adj} R_2$$

Figure 24. Adjustable Output Regulator

The output ripple will increase linearly for fixed and adjustable devices as the ratio of output voltage to the reference voltage increases. For example, with a 12 V regulator, the output ripple will increase by 12 V/1.25 V or 9.6 and the ripple rejection will decrease by 20 log of this ratio or 19.6 dB. The loss of ripple rejection can be restored to the values shown with the addition of bypass capacitor  $C_{adj}$ , shown in Figure 24. The reactance of  $C_{adj}$  at the ripple frequency must be less than the resistance of R1. The value of R1 can be selected to provide the minimum required load current to maintain regulation and is usually in the range of 100  $\Omega$  to 200  $\Omega$ .

$$C_{adj} > \frac{1}{2 \pi f_{ripple} R_1}$$

The minimum required capacitance can be calculated from the above formula. When using the device in an application that is powered from the AC line via a transformer and a full wave bridge, the value for  $C_{adj}$  is:

$$f_{ripple} = 120 \text{ Hz}, R_1 = 120 \Omega, \text{ then } C_{adj} > 11.1 \mu\text{F}$$

The value for  $C_{adj}$  is significantly reduced in applications where the input ripple frequency is high. If used as a post regulator in a switching converter under the following conditions:

$$f_{ripple} = 50 \text{ kHz}, R_1 = 120 \Omega, \text{ then } C_{adj} > 0.027 \mu\text{F}$$

Figures 10 and 11 shows the level of ripple rejection that is obtainable with the adjust pin properly bypassed.

**Protection Diodes**

The NCP1117 family has two internal low impedance diode paths that normally do not require protection when used in the typical regulator applications. The first path connects between  $V_{out}$  and  $V_{in}$ , and it can withstand a peak surge current of about 15 A. Normal cycling of  $V_{in}$  cannot generate a current surge of this magnitude. Only when  $V_{in}$  is shorted or crowbarred to ground and  $C_{out}$  is greater than 50  $\mu$ F, it becomes possible for device damage to occur. Under these conditions, diode D1 is required to protect the device. The second path connects between  $C_{adj}$  and  $V_{out}$ , and it can withstand a peak surge current of about 150 mA. Protection diode D2 is required if the output is shorted or crowbarred to ground and  $C_{adj}$  is greater than 1.0  $\mu$ F.

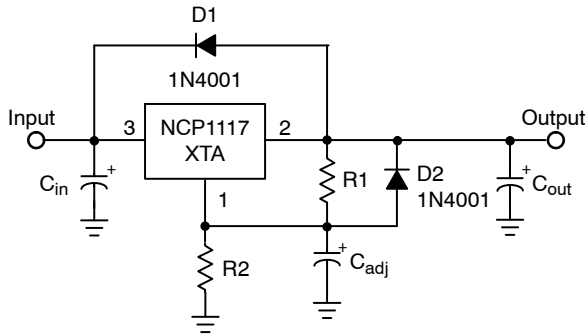

**Figure 25. Protection Diode Placement**

A combination of protection diodes D1 and D2 may be required in the event that  $V_{in}$  is shorted to ground and  $C_{adj}$  is greater than 50  $\mu$ F. The peak current capability stated for the internal diodes are for a time of 100  $\mu$ s with a junction temperature of 25°C. These values may vary and are to be used as a general guide.

**Load Regulation**

The NCP1117 series is capable of providing excellent load regulation; but since these are three terminal devices, only partial remote load sensing is possible. There are two conditions that must be met to achieve the maximum available load regulation performance. The first is that the top side of programming resistor R1 should be connected as close to the regulator case as practicable. This will minimize the voltage drop caused by wiring resistance  $RW+$  from appearing in series with reference voltage that is across R1.

The second condition is that the ground end of R2 should be connected directly to the load. This allows true Kelvin sensing where the regulator compensates for the voltage drop caused by wiring resistance  $RW-$ .

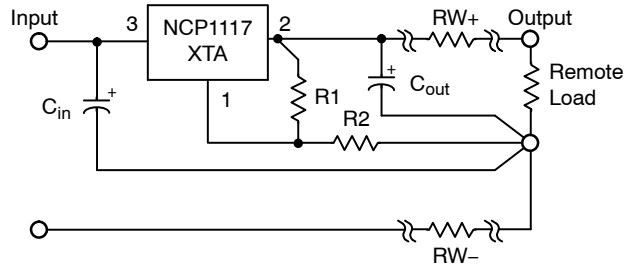

**Figure 26. Load Sensing**

**Thermal Considerations**

This series contains an internal thermal limiting circuit that is designed to protect the regulator in the event that the maximum junction temperature is exceeded. When activated, typically at 175°C, the regulator output switches off and then back on as the die cools. As a result, if the device is continuously operated in an overheated condition, the output will appear to be oscillating. This feature provides protection from a catastrophic device failure due to accidental overheating. It is not intended to be used as a substitute for proper heatsinking. The maximum device power dissipation can be calculated by:

$$P_D = \frac{T_{J(max)} - T_A}{R_{\theta JA}}$$

The devices are available in surface mount SOT-223 and DPAK packages. Each package has an exposed metal tab that is specifically designed to reduce the junction to air thermal resistance,  $R_{\theta JA}$ , by utilizing the printed circuit board copper as a heat dissipater. Figures 21 and 22 show typical  $R_{\theta JA}$  values that can be obtained from a square pattern using economical single sided 2.0 ounce copper board material. The final product thermal limits should be tested and quantified in order to insure acceptable performance and reliability. The actual  $R_{\theta JA}$  can vary considerably from the graphs shown. This will be due to any changes made in the copper aspect ratio of the final layout, adjacent heat sources, and air flow.

# NCP1117, NCP1117I, NCV1117



Figure 27. Constant Current Regulator



Figure 28. Slow Turn-On Regulator



Figure 29. Regulator with Shutdown



Resistor R2 sets the maximum output voltage. Each transistor reduces the output voltage when turned on.

Figure 30. Digitally Controlled Regulator



The 50 Ω resistor that is in series with the ground pin of the upper regulator level shifts its output 300 mV higher than the lower regulator. This keeps the lower regulator off until the input source is removed.

Figure 31. Battery Backed-Up Power Supply



Figure 32. Adjusting Output of Fixed Voltage Regulators

## NCP1117, NCP1117I, NCV1117

### ORDERING INFORMATION – (NCP1117)

Device	Nominal Output Voltage	Package	Shipping <sup>†</sup>
NCP1117STAT3G	Adjustable	SOT-223 (Pb-Free)	4000 / Tape & Reel
NCP1117ST15T3G	1.5		
NCP1117ST18T3G	1.8		
NCP1117ST20T3G	2.0		
NCP1117ST25T3G	2.5		
NCP1117ST33T3G	3.3		
NCP1117ST50T3G	5.0		
NCP1117ST12T3G	12		
NCP1117DTAG	Adjustable	DPAK (Pb-Free)	75 Units / Rail
NCP1117DTARKG	Adjustable		2500 / Tape & Reel
NCP1117DTAT5G	Adjustable		2500 / Tape & Reel
NCP1117DT15G	1.5		75 Units / Rail
NCP1117DT15RKG	1.5		2500 / Tape & Reel
NCP1117DT18G	1.8		75 Units / Rail
NCP1117DT18RKG	1.8		2500 / Tape & Reel
NCP1117DT18T5G	1.8		2500 / Tape & Reel
NCP1117DT19RKG	1.9		2500 / Tape & Reel
NCP1117DT20G	2.0		75 Units / Rail
NCP1117DT20RKG	2.0		2500 / Tape & Reel
NCP1117DT25G	2.5		75 Units / Rail
NCP1117DT25RKG	2.5		2500 / Tape & Reel
NCP1117DT25T5G	2.5		2500 / Tape & Reel
NCP1117DT285G	2.85		75 Units / Rail
NCP1117DT285RKG	2.85		2500 / Tape & Reel
NCP1117DT33G	3.3		75 Units / Rail
NCP1117DT33RKG	3.3		2500 / Tape & Reel
NCP1117DT33T5G	3.3		2500 / Tape & Reel
NCP1117DT50G	5.0		75 Units / Rail
NCP1117DT50RKG	5.0	2500 / Tape & Reel	
NCP1117DT12G	12	75 Units / Rail	
NCP1117DT12RKG	12	2500 / Tape & Reel	

†For information on tape and reel specifications, including part orientation and tape sizes, please refer to our Tape and Reel Packaging Specifications Brochure, BRD8011/D.

### ORDERING INFORMATION – (NCP1117I)

Device	Nominal Output Voltage	Package	Shipping <sup>†</sup>
NCP1117I STAT3G	Adjustable	SOT-223 (Pb-Free)	4000 / Tape & Reel
NCP1117I ST18T3G	1.8		
NCP1117I ST33T3G	3.3		
NCP1117I ST50T3G	5.0		
NCP1117I DTAT4G	Adjustable	DPAK (Pb-Free)	2500 / Tape & Reel
NCP1117I DT33T4G	3.3		
NCP1117I DT50T4G	5.0		

†For information on tape and reel specifications, including part orientation and tape sizes, please refer to our Tape and Reel Packaging Specifications Brochure, BRD8011/D.

## NCP1117, NCP1117I, NCV1117

### ORDERING INFORMATION – (NCV1117)

Device	Nominal Output Voltage	Package	Shipping <sup>†</sup>
NCV1117STAT3G*	Adjustable	SOT-223 (Pb-Free)	4000 / Tape & Reel
NCV1117ST15T3G*	1.5		
NCV1117ST18T3G*	1.8		
NCV1117ST20T3G*	2.0		
NCV1117ST25T3G*	2.5		
NCV1117ST33T3G*	3.3		
NCV1117ST50T3G*	5.0		
NCV1117ST12T3G*	12		
NCV1117DTARKG*	Adjustable	DPAK (Pb-Free)	2500 / Tape & Reel
NCV1117DT15RKG*	1.5		
NCV1117DT18RKG*	1.8		
NCV1117DT18T5G*	1.8		
NCV1117DT20RKG*	2.0		
NCV1117DT25RKG*	2.5		
NCV1117DT33T4G*	3.3		
NCV1117DT33T5G*	3.3		
NCV1117DT50RKG*	5.0		
NCV1117DT12RKG*	12		

†For information on tape and reel specifications, including part orientation and tape sizes, please refer to our Tape and Reel Packaging Specifications Brochure, BRD8011/D.

\*NCV Prefix for Automotive and Other Applications Requiring Unique Site and Control Change Requirements; AEC-Q100 Qualified and PPAP Capable

# NCP1117, NCP1117I, NCV1117

## MARKING DIAGRAMS – NCP1117

SOT-223  
ST SUFFIX  
CASE 318H



DPAK  
DT SUFFIX  
CASE 369C

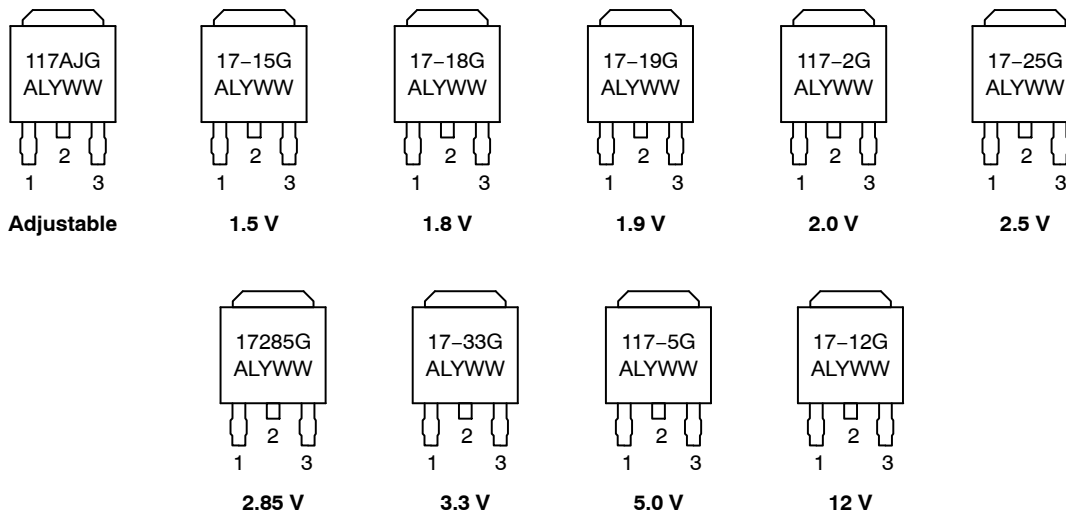

A = Assembly Location  
L = Wafer Lot  
Y = Year  
WW, W = Work Week  
▪ or G = Pb-Free Package  
(Note: Microdot may be in either location)

# NCP1117, NCP1117I, NCV1117

## MARKING DIAGRAMS – NCP1117I

### SOT-223 ST SUFFIX CASE 318H



### DPAK DT SUFFIX CASE 369C



A = Assembly Location

L = Wafer Lot

Y = Year

WW, W = Work Week

▪ or G = Pb-Free Package

(Note: Microdot may be in either location)

# NCP1117, NCP1117I, NCV1117

## MARKING DIAGRAMS – NCV1117

### SOT-223 ST SUFFIX CASE 318H



**Adjustable**



**1.5 V**



**1.8 V**



**2.0 V**



**2.5 V**



**3.3 V**



**5.0 V**



**12 V**

### DPAK DT SUFFIX CASE 369C



**Adjustable**

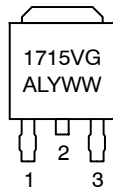

**1.5 V**



**1.8 V**

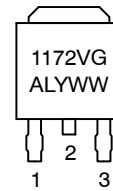

**2.0 V**

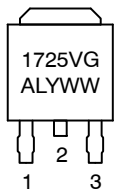

**2.5 V**

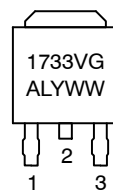

**3.3 V**



**5.0 V**

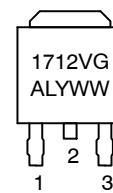

**12 V**

A = Assembly Location

L = Wafer Lot

Y = Year

WW, W = Work Week

▪ or G = Pb-Free Package

(Note: Microdot may be in either location)

# MECHANICAL CASE OUTLINE

## PACKAGE DIMENSIONS

ON Semiconductor®



**SOT-223**  
CASE 318H  
ISSUE B

DATE 13 MAY 2020

SCALE 2:1



TOP VIEW

$\text{Ø} 0.10 \text{ (M) C A B}$

NOTE 7



SIDE VIEW



END VIEW

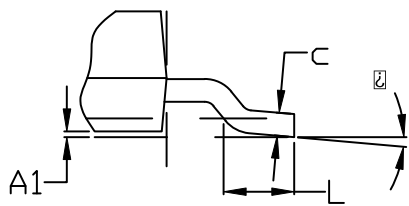

DETAIL A

**NOTES:**

1. DIMENSIONING AND TOLERANCING PER ASME Y14.5M, 2009.
2. CONTROLLING DIMENSION: MILLIMETERS
3. DIMENSIONS D & E1 ARE DETERMINED AT DATUM H. DIMENSIONS DO NOT INCLUDE MOLD FLASH, PROTRUSIONS OR GATE BURRS. SHALL NOT EXCEED 0.23mm PER SIDE.
4. LEAD DIMENSIONS b AND b1 DO NOT INCLUDE DAMBAR PROTRUSION. ALLOWABLE DAMBAR PROTRUSION IS 0.08mm PER SIDE.
5. DATUMS A AND B ARE DETERMINED AT DATUM H.
6. A1 IS DEFINED AS THE VERTICAL DISTANCE FROM THE SEATING PLANE TO THE LOWEST POINT OF THE PACKAGE BODY.
7. POSITIONAL TOLERANCE APPLIES TO DIMENSIONS b AND b1.

DIM	MILLIMETERS		
	MIN.	NDM.	MAX.
A	---	---	1.80
A1	0.02	0.06	0.11
b	0.60	0.74	0.88
b1	2.90	3.00	3.10
c	0.24	---	0.35
D	6.30	6.50	6.70
E	6.70	7.00	7.30
E1	3.30	3.50	3.70
e	2.30 BSC		
L	0.25	---	---
$\text{Ø}$	0°	---	10°

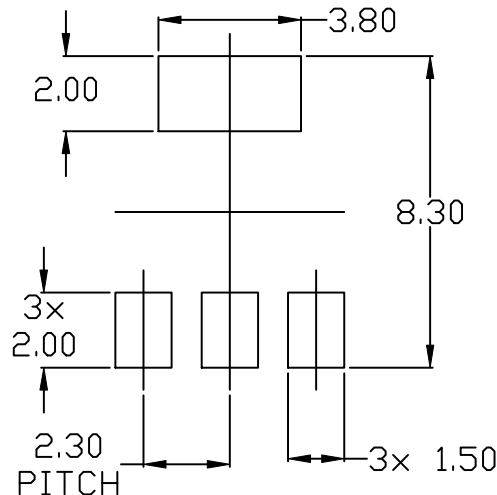

RECOMMENDED MOUNTING FOOTPRINT

\* For additional information on our Pb-Free strategy and soldering details, please download the ON Semiconductor Soldering and Mounting Techniques Reference Manual, SOLDERM/D.

**GENERIC MARKING DIAGRAM\***

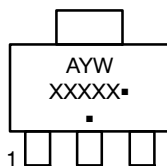

- A = Assembly Location
- Y = Year
- W = Work Week
- XXXXX = Specific Device Code
- = Pb-Free Package

(Note: Microdot may be in either location)

\*This information is generic. Please refer to device data sheet for actual part marking. Pb-Free indicator, "G" or microdot "▪", may or may not be present. Some products may not follow the Generic Marking.

<b>DOCUMENT NUMBER:</b>	<b>98ASH70634A</b>	Electronic versions are uncontrolled except when accessed directly from the Document Repository. Printed versions are uncontrolled except when stamped "CONTROLLED COPY" in red.
<b>DESCRIPTION:</b>	<b>SOT-223</b>	<b>PAGE 1 OF 1</b>

ON Semiconductor and are trademarks of Semiconductor Components Industries, LLC dba ON Semiconductor or its subsidiaries in the United States and/or other countries. ON Semiconductor reserves the right to make changes without further notice to any products herein. ON Semiconductor makes no warranty, representation or guarantee regarding the suitability of its products for any particular purpose, nor does ON Semiconductor assume any liability arising out of the application or use of any product or circuit, and specifically disclaims any and all liability, including without limitation special, consequential or incidental damages. ON Semiconductor does not convey any license under its patent rights nor the rights of others.

# MECHANICAL CASE OUTLINE PACKAGE DIMENSIONS

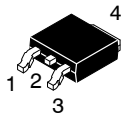

## DPAK (SINGLE GAUGE) CASE 369C ISSUE G

DATE 31 MAY 2023

SCALE 1:1

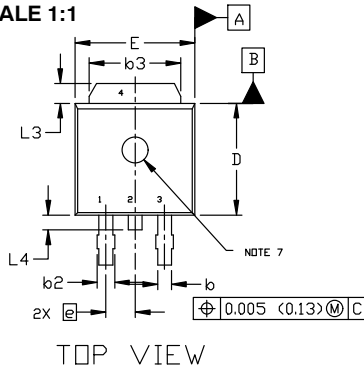

TOP VIEW

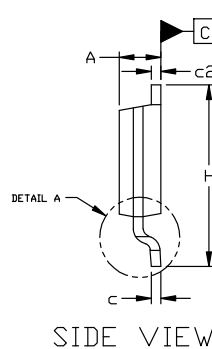

SIDE VIEW

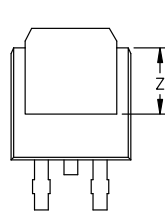

BOTTOM VIEW

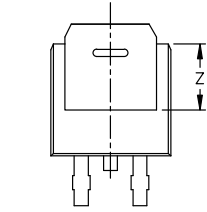
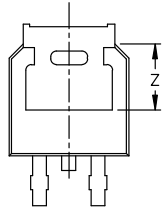

BOTTOM VIEW

ALTERNATE CONSTRUCTIONS

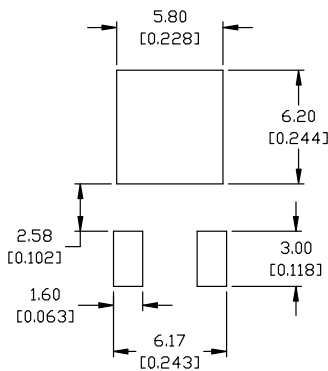

### RECOMMENDED MOUNTING FOOTPRINT\*

\*FOR ADDITIONAL INFORMATION ON OUR Pb-FREE STRATEGY AND SOLDERING DETAILS, PLEASE DOWNLOAD THE ON SEMICONDUCTOR SOLDERING AND MOUNTING TECHNIQUES REFERENCE MANUAL, SOLDERM/D.

- |  |  |   |   |  |
|--|--|---|---|--|
| <b>STYLE 1:</b><br>PIN 1. BASE<br>2. COLLECTOR<br>3. EMITTER<br>4. COLLECTOR | <b>STYLE 2:</b><br>PIN 1. GATE<br>2. DRAIN<br>3. SOURCE<br>4. DRAIN          | <b>STYLE 3:</b><br>PIN 1. ANODE<br>2. CATHODE<br>3. ANODE<br>4. CATHODE | <b>STYLE 4:</b><br>PIN 1. CATHODE<br>2. ANODE<br>3. GATE<br>4. ANODE              | <b>STYLE 5:</b><br>PIN 1. GATE<br>2. ANODE<br>3. CATHODE<br>4. ANODE     |
| <b>STYLE 6:</b><br>PIN 1. MT1<br>2. MT2<br>3. GATE<br>4. MT2                 | <b>STYLE 7:</b><br>PIN 1. GATE<br>2. COLLECTOR<br>3. EMITTER<br>4. COLLECTOR | <b>STYLE 8:</b><br>PIN 1. N/C<br>2. CATHODE<br>3. ANODE<br>4. CATHODE   | <b>STYLE 9:</b><br>PIN 1. ANODE<br>2. CATHODE<br>3. RESISTOR ADJUST<br>4. CATHODE | <b>STYLE 10:</b><br>PIN 1. CATHODE<br>2. ANODE<br>3. CATHODE<br>4. ANODE |

### NOTES:

- DIMENSIONING AND TOLERANCING ASME Y14.5M, 1994.
- CONTROLLING DIMENSION: INCHES
- THERMAL PAD CONTOUR OPTIONAL WITHIN DIMENSIONS b3, L3, AND Z.
- DIMENSIONS D AND E DO NOT INCLUDE MOLD FLASH, PROTRUSIONS, OR BURRS. MOLD FLASH, PROTRUSIONS, OR GATE BURRS SHALL NOT EXCEED 0.006 INCHES PER SIDE.
- DIMENSIONS D AND E ARE DETERMINED AT THE OUTERMOST EXTREMES OF THE PLASTIC BODY.
- DATUMS A AND B ARE DETERMINED AT DATUM PLANE H.
- OPTIONAL MOLD FEATURE.

DIM	INCHES		MILLIMETERS	
	MIN.	MAX.	MIN.	MAX.
A	0.086	0.094	2.18	2.38
A1	0.000	0.005	0.00	0.13
b	0.025	0.035	0.63	0.89
b2	0.028	0.045	0.72	1.14
b3	0.180	0.215	4.57	5.46
c	0.018	0.024	0.46	0.61
c2	0.018	0.024	0.46	0.61
D	0.235	0.245	5.97	6.22
E	0.250	0.265	6.35	6.73
e	0.090	BSC	2.29	BSC
H	0.370	0.410	9.40	10.41
L	0.055	0.070	1.40	1.78
L1	0.114	REF	2.90	REF
L2	0.020	BSC	0.51	BSC
L3	0.035	0.050	0.89	1.27
L4	----	0.040	---	1.01
Z	0.155	----	3.93	---

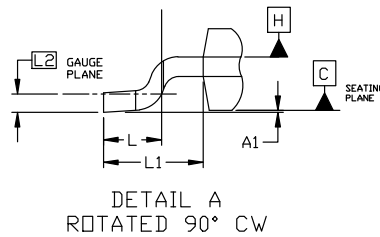

DETAIL A  
ROTATED 90° CW

### GENERIC MARKING DIAGRAM\*

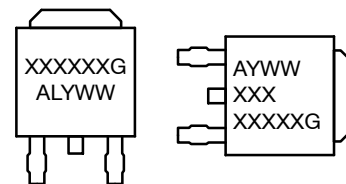

- IC**  
 XXXXXX = Device Code  
 A = Assembly Location  
 L = Wafer Lot  
 Y = Year  
 WW = Work Week  
 G = Pb-Free Package
- Discrete**  
 AYWW  
 XXX  
 XXXXXG

\*This information is generic. Please refer to device data sheet for actual part marking. Pb-Free indicator, "G" or microdot "•", may or may not be present. Some products may not follow the Generic Marking.

<b>DOCUMENT NUMBER:</b>	<b>98AON10527D</b>	Electronic versions are uncontrolled except when accessed directly from the Document Repository. Printed versions are uncontrolled except when stamped "CONTROLLED COPY" in red.
<b>DESCRIPTION:</b>	<b>DPAK (SINGLE GAUGE)</b>	<b>PAGE 1 OF 1</b>

onsemi and onsemi are trademarks of Semiconductor Components Industries, LLC dba onsemi or its subsidiaries in the United States and/or other countries. onsemi reserves the right to make changes without further notice to any products herein. onsemi makes no warranty, representation or guarantee regarding the suitability of its products for any particular purpose, nor does onsemi assume any liability arising out of the application or use of any product or circuit, and specifically disclaims any and all liability, including without limitation special, consequential or incidental damages. onsemi does not convey any license under its patent rights nor the rights of others.

**onsemi**, **Onsemi**, and other names, marks, and brands are registered and/or common law trademarks of Semiconductor Components Industries, LLC dba "**onsemi**" or its affiliates and/or subsidiaries in the United States and/or other countries. **onsemi** owns the rights to a number of patents, trademarks, copyrights, trade secrets, and other intellectual property. A listing of **onsemi**'s product/patent coverage may be accessed at [www.onsemi.com/site/pdf/Patent-Marking.pdf](http://www.onsemi.com/site/pdf/Patent-Marking.pdf). **onsemi** reserves the right to make changes at any time to any products or information herein, without notice. The information herein is provided "as-is" and **onsemi** makes no warranty, representation or guarantee regarding the accuracy of the information, product features, availability, functionality, or suitability of its products for any particular purpose, nor does **onsemi** assume any liability arising out of the application or use of any product or circuit, and specifically disclaims any and all liability, including without limitation special, consequential or incidental damages. Buyer is responsible for its products and applications using **onsemi** products, including compliance with all laws, regulations and safety requirements or standards, regardless of any support or applications information provided by **onsemi**. "Typical" parameters which may be provided in **onsemi** data sheets and/or specifications can and do vary in different applications and actual performance may vary over time. All operating parameters, including "Typicals" must be validated for each customer application by customer's technical experts. **onsemi** does not convey any license under any of its intellectual property rights nor the rights of others. **onsemi** products are not designed, intended, or authorized for use as a critical component in life support systems or any FDA Class 3 medical devices or medical devices with a same or similar classification in a foreign jurisdiction or any devices intended for implantation in the human body. Should Buyer purchase or use **onsemi** products for any such unintended or unauthorized application, Buyer shall indemnify and hold **onsemi** and its officers, employees, subsidiaries, affiliates, and distributors harmless against all claims, costs, damages, and expenses, and reasonable attorney fees arising out of, directly or indirectly, any claim of personal injury or death associated with such unintended or unauthorized use, even if such claim alleges that **onsemi** was negligent regarding the design or manufacture of the part. **onsemi** is an Equal Opportunity/Affirmative Action Employer. This literature is subject to all applicable copyright laws and is not for resale in any manner.

## ADDITIONAL INFORMATION

### TECHNICAL PUBLICATIONS:

Technical Library: [www.onsemi.com/design/resources/technical-documentation](http://www.onsemi.com/design/resources/technical-documentation)  
onsemi Website: [www.onsemi.com](http://www.onsemi.com)

### ONLINE SUPPORT: [www.onsemi.com/support](http://www.onsemi.com/support)

For additional information, please contact your local Sales Representative at [www.onsemi.com/support/sales](http://www.onsemi.com/support/sales)

## Looking for pricing, stock, or lifecycle information?

Click below to explore more details on WIN SOURCE:

- ⊖ [View NCP1117DT18RK on WIN SOURCE](#)
- ⊖ [ON Semiconductor Information](#)

## Optimize Your Supply Chain with WIN SOURCE Solutions

- ✓ Global Sourcing Solution
- ✓ Obsolete Management
- ✓ Cost Control Management
- ✓ Shortage Management
- ✓ Alternative Solution
- ✓ Excess Inventory Management