

Microelectronic Power IC
 HEXFET® Power MOSFET Photovoltaic Relay
 Dual Pole, Normally Open, 0-250V, 170mA AC/DC

General Description

The PVT322 Series Photovoltaic Relay is a dual-pole, normally open solid-state relay that can replace electromechanical relays in many applications. It utilizes International Rectifier's HEXFET power MOSFET as the output switch, driven by an integrated circuit photovoltaic generator of novel construction. The output switch is controlled by radiation from a GaAlAs light emitting diode (LED) which is optically isolated from the photovoltaic generator.

Series PVT322 Relays are packaged in an 8-pin, molded DIP package with either thru-hole or surface mount (gull-wing) terminals. It is available in standard plastic shipping tubes or on tape-and-reel. Please refer to Part Identification information opposite.

Applications

- On/Off Hook switch
- Tip and Ring Line switching
- General switching

Features

- HEXFET® Power MOSFET output
- Bounce-free operation
- 4,000 V_{RMS} I/O isolation
- Linear AC/DC operation
- Solid-State Reliability
- UL recognized and BAPT certified

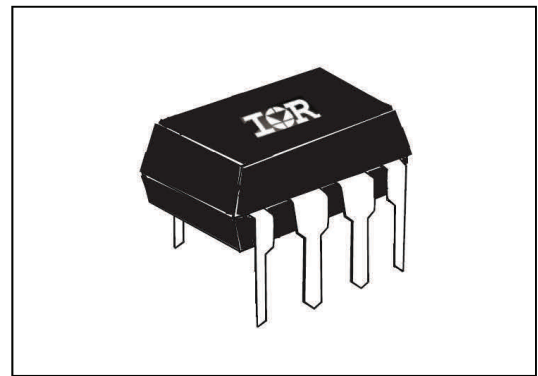

Part Identification

PVT322PbF	thru-hole
PVT322SPbF	Surface-mount
PVT322S-TPbF	Surface-mount, Tape and Reel

(HEXFET is the registered trademark for International Rectifier Power MOSFETs)

Electrical Specifications ($-40^{\circ}\text{C} \leq T_A \leq +85^{\circ}\text{C}$ unless otherwise specified)

INPUT CHARACTERISTICS	Limits	Units
Minimum Control Current (See figure 1)	2.0	mA
Maximum Control Current for Off-State Resistance @ $T_A=+25^{\circ}\text{C}$	0.4	mA
Control Current Range (Caution: current limit input LED, see figure 5)	2.0 to 25	mA
Maximum Reverse Voltage	6.0	V

OUTPUT CHARACTERISTICS	Limits	Units
Operating Voltage Range	0 to ± 250	$V_{(\text{DC or AC peak})}$
Maximum Load Current @ $T_A=+40^{\circ}\text{C}$ 5mA Control (See figure 1) (single and dual channel operation)	170	mA
Maximum Peak Load Current (10ms maximum duration) (single and dual channel operation)	500	mA
Maximum On-State Resistance @ $T_A=+25^{\circ}\text{C}$ For 50mA Pulsed load, 5mA Control (see figure 3)	10	Ω
Maximum Off-State Leakage @ $T_A=+25^{\circ}\text{C}$, $\pm 250\text{V}$ (see figure 4)	1.0	μA
Maximum Turn-On Time @ $T_A=+25^{\circ}\text{C}$ (see figure 6) For 50mA, 100 V_{DC} load, 5mA Control	3.0	ms
Maximum Turn-Off Time @ $T_A=+25^{\circ}\text{C}$ (see figure 6) For 50mA, 100 V_{DC} load, 5mA Control	0.5	ms
Maximum Output Capacitance @ 50 V_{DC}	50	pF

GENERAL CHARACTERISTICS	Limits	Units	
Minimum Dielectric Strength, Input-Output	4000	V_{RMS}	
Minimum Dielectric Strength, Pole-to-Pole	1000	V_{DC}	
Minimum Insulation Resistance, Input-Output, @ $T_A=+25^{\circ}\text{C}$, 50%RH, 100 V_{DC}	10^{12}	Ω	
Maximum Capacitance, Input-Output	1.0	pF	
Maximum Pin Soldering Temperature (10 seconds maximum)	+260	$^{\circ}\text{C}$	
Ambient Temperature Range:	Operating		-40 to 85
	Storage		-40 to 100

International Rectifier does not recommend the use of this product in aerospace, avionics, military or life support applications. Users of this International Rectifier product in such applications assume all risks of such use and indemnify International Rectifier against all damages resulting from such use.

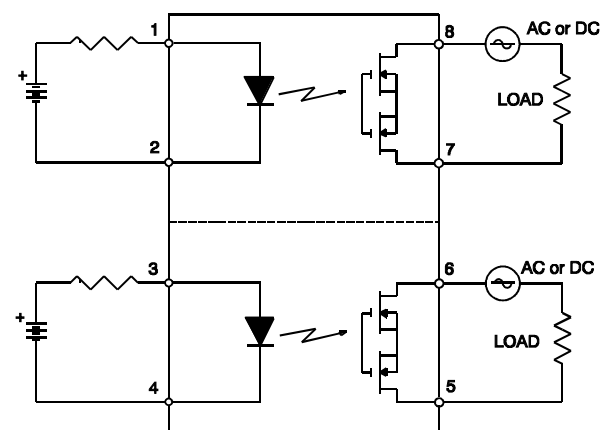
Connection Diagram

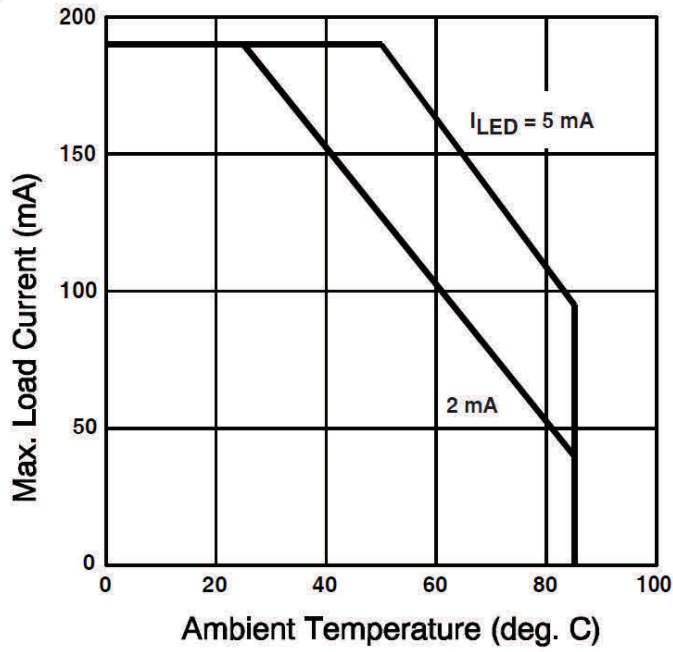

Figure 1. Typical Current Derating Curve

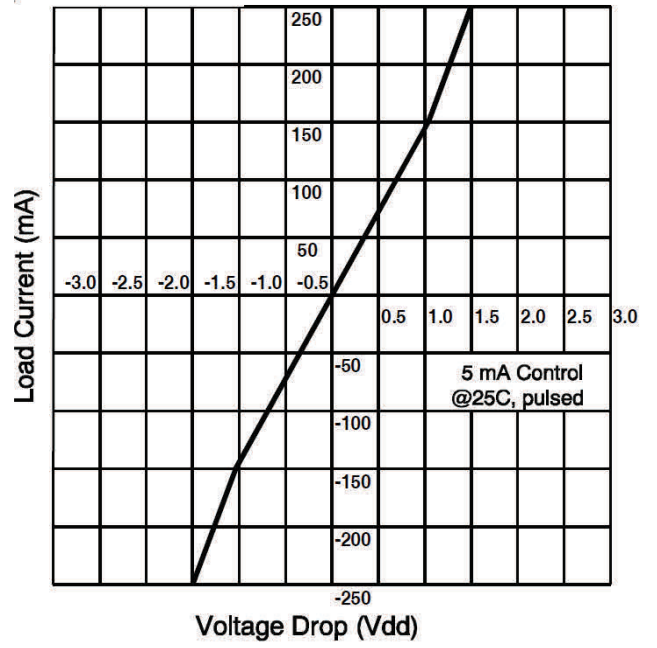

Figure 2. Linearity Characteristics

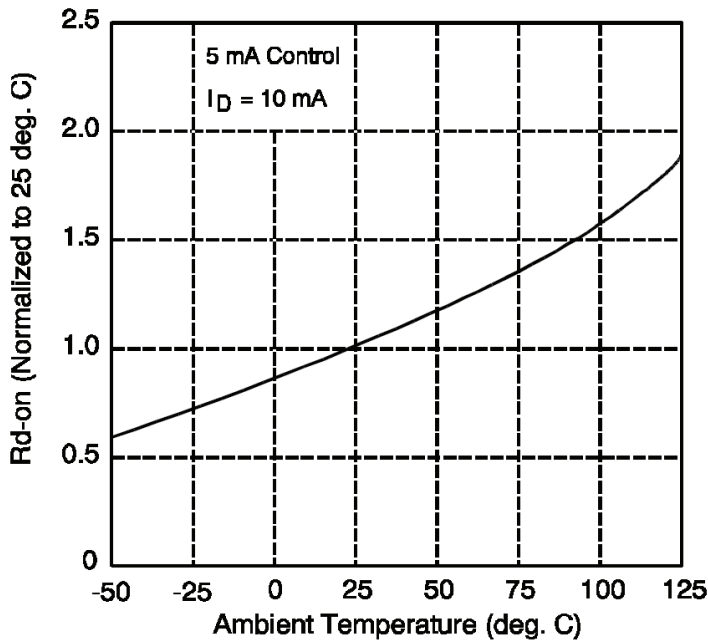

Figure 3. Typical Normalized On-Resistance

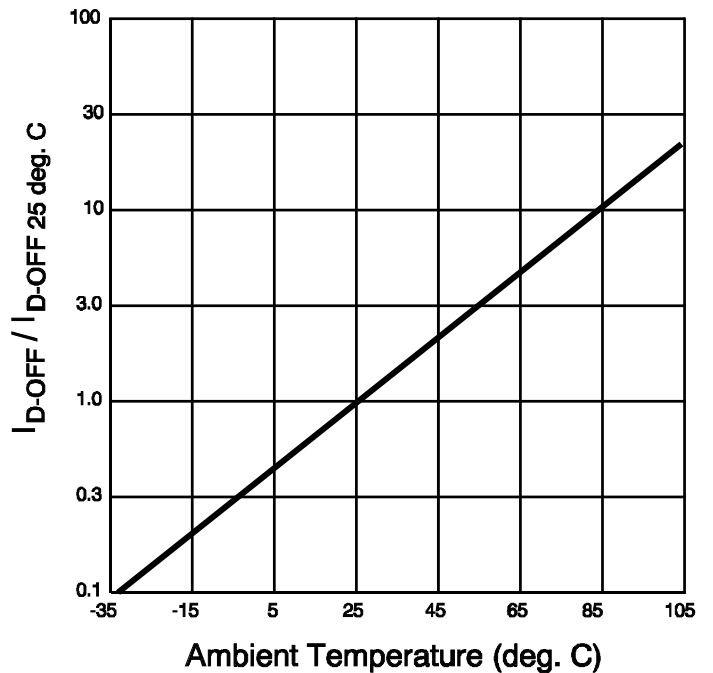

Figure 4. Typical Normalized Off-State Leakage

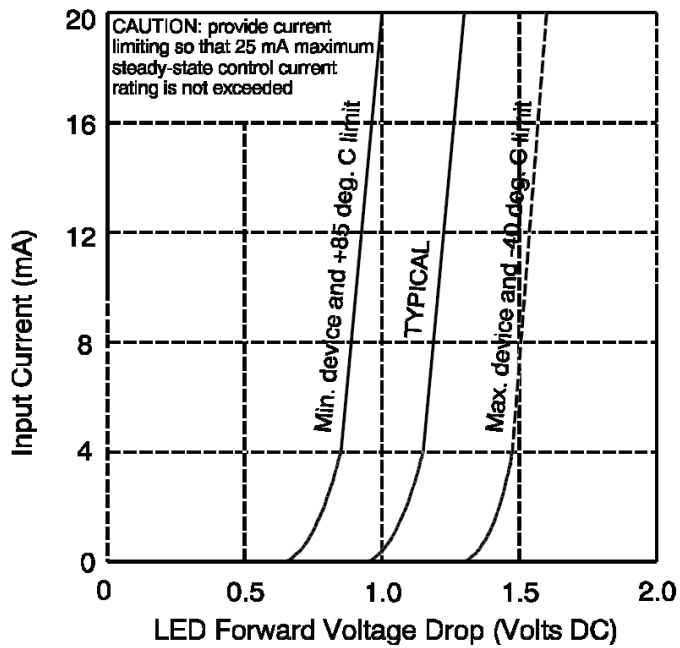

Figure 5. Input Characteristics (Current Controlled)

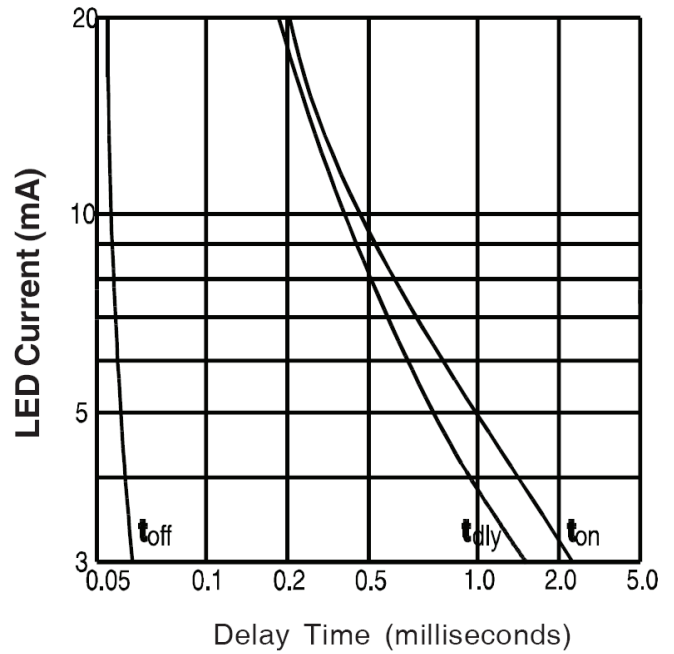

Figure 6. Typical Delay Times

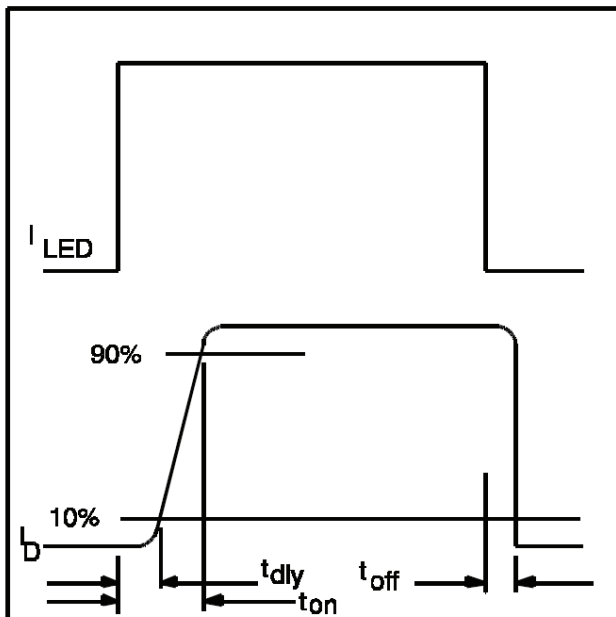

Figure 7. Delay Time Definitions

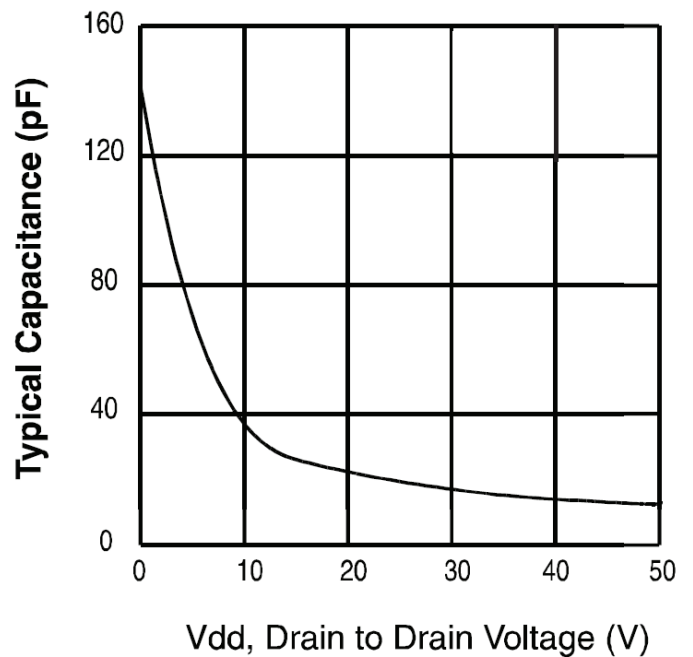
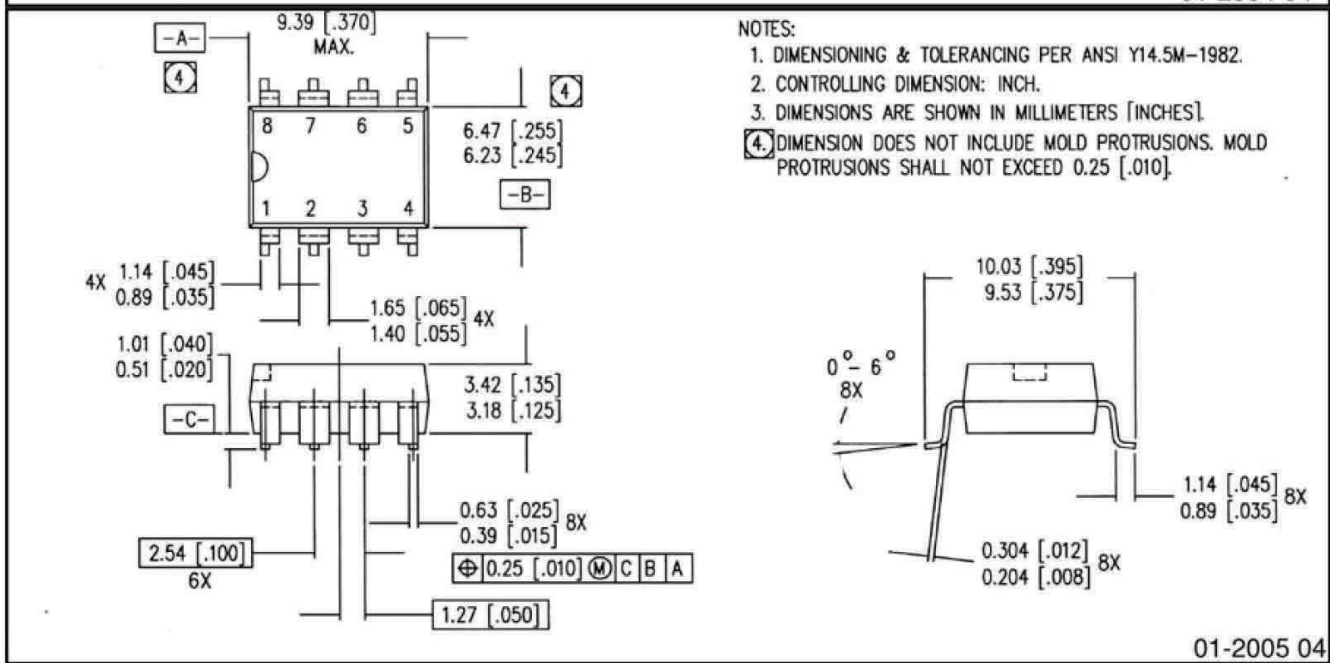
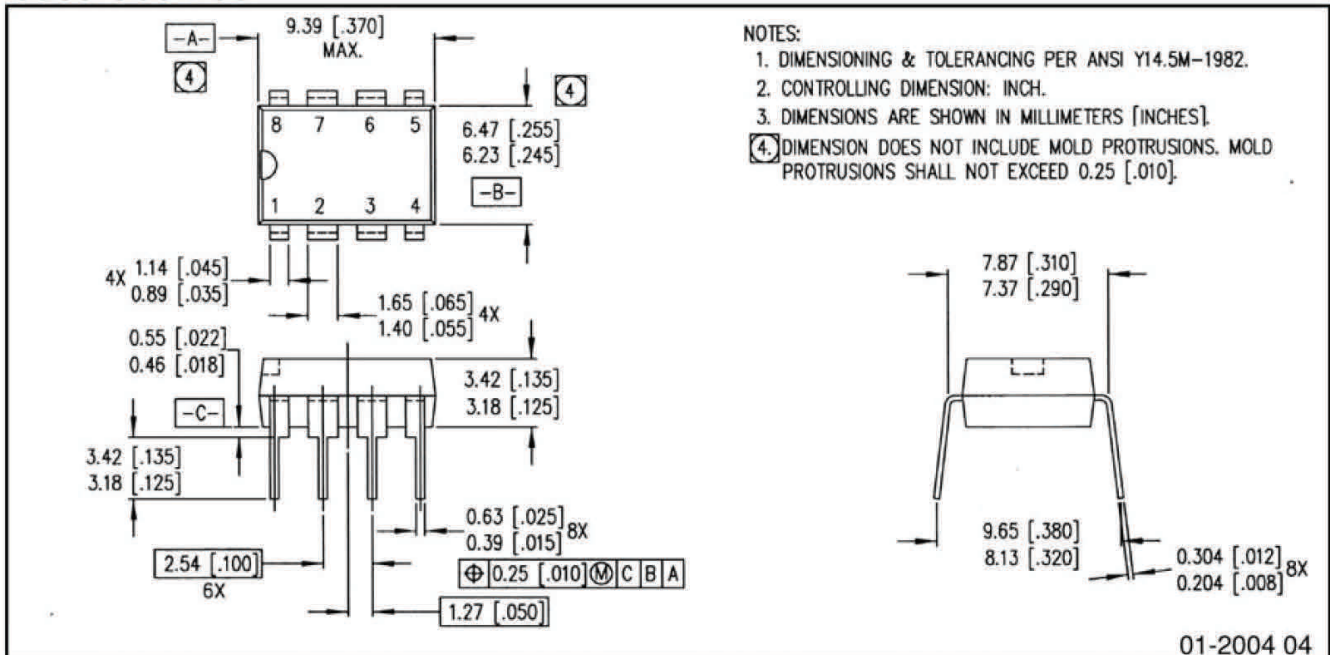

Figure 8. Typical Output Capacitance

Case Outline



Note: For the most current drawing please refer to IR website at: <http://www.irf.com/package/>

Qualification Information[†]

Qualification Level	Industrial (per JEDEC JESD47F [†] guidelines)	
Moisture Sensitivity Level	PVT322PbF	N/A
	PVT322SPbF	MSL4
	PVT322PbF	(per JEDEC J-STD-020E & JEDEC J-STD-033C [†])
RoHS Compliant	Yes	

† Applicable version of JEDEC standard at the time of product release.

Revision History

Date	Comment
6/2/2015	<ul style="list-style-type: none"> • Added Qualification Information Table on page 6. • Updated data sheet based wit new IR corporate template.
8/29/2016	<ul style="list-style-type: none"> • Corrected typo from “Single Pole” to “Dual Pole” on page 1. • Updated "Infineon" logo –all pages. • Updated disclaimer on last page.

Published by
Infineon Technologies AG
81726 München, Germany
© Infineon Technologies AG 2015
All Rights Reserved.

IMPORTANT NOTICE

The information given in this document shall in no event be regarded as a guarantee of conditions or characteristics ("Beschaffenheitsgarantie"). With respect to any examples, hints or any typical values stated herein and/or any information regarding the application of the product, Infineon Technologies hereby disclaims any and all warranties and liabilities of any kind, including without limitation warranties of non-infringement of intellectual property rights of any third party.

In addition, any information given in this document is subject to customer's compliance with its obligations stated in this document and any applicable legal requirements, norms and standards concerning customer's products and any use of the product of Infineon Technologies in customer's applications.

The data contained in this document is exclusively intended for technically trained staff. It is the responsibility of customer's technical departments to evaluate the suitability of the product for the intended application and the completeness of the product information given in this document with respect to such application.

For further information on the product, technology, delivery terms and conditions and prices please contact your nearest Infineon Technologies office (www.infineon.com).



WARNINGS

Due to technical requirements products may contain dangerous substances. For information on the types in question please contact your nearest Infineon Technologies office.

Except as otherwise explicitly approved by Infineon Technologies in a written document signed by authorized representatives of Infineon Technologies, Infineon Technologies' products may not be used in any applications where a failure of the product or any consequences of the use thereof can reasonably be expected to result in personal injury.

Looking for pricing, stock, or lifecycle information?

Click below to explore more details on WIN SOURCE:

-  [View PVT322 on WIN SOURCE](#)
-  [Infineon Technologies](#) Information

Optimize Your Supply Chain with WIN SOURCE Solutions

-  Global Sourcing Solution
-  Obsolete Management
-  Cost Control Management
-  Shortage Management
-  Alternative Solution
-  Excess Inventory Management