



**THE DATASHEET OF
ADR381ART-REEL7**



FEATURES

- Initial accuracy:** ± 5 mV/ ± 6 mV maximum
- Initial accuracy error:** $\pm 0.24\%$ / $\pm 0.24\%$
- Low TC_{V_{OUT}}:** 25 ppm/ $^{\circ}$ C maximum
- Load regulation:** 70 ppm/mA
- Line regulation:** 25 ppm/V
- Wide operating ranges**
 - 2.4 V to 18 V for ADR380
 - 2.8 V to 18 V for ADR381
- Low power:** 120 μ A maximum
- High output current:** 5 mA
- Wide temperature range:** -40° C to $+85^{\circ}$ C
- Tiny 3-lead SOT-23 package with standard pinout**

APPLICATIONS

- Battery-powered instrumentation
- Portable medical instruments
- Data acquisition systems
- Industrial process control systems
- Hard disk drives
- Automotive

GENERAL DESCRIPTION

The ADR380 and ADR381 are precision 2.048 V and 2.500 V band gap voltage references featuring high accuracy, high stability, and low power consumption in a tiny footprint. Patented temperature drift curvature correction techniques minimize nonlinearity of the voltage change with temperature. The wide operating range and low power consumption make them ideal for 3 V to 5 V battery-powered applications.

The ADR380 and ADR381 are micropower, low dropout voltage (LDV) devices that provide a stable output voltage from supplies as low as 300 mV above the output voltage. They are specified over the industrial (-40° C to $+85^{\circ}$ C) temperature range. The ADR380/ADR381 are available in the tiny 3-lead SOT-23 package.

PIN CONFIGURATION

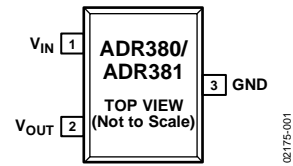

Figure 1. 3-Lead SOT-23
(RT Suffix)

Table 1. ADR38x Products

Part Number	Nominal Output Voltage (V)
ADR380	2.048
ADR381	2.500

Rev. C

Information furnished by Analog Devices is believed to be accurate and reliable. However, no responsibility is assumed by Analog Devices for its use, nor for any infringements of patents or other rights of third parties that may result from its use. Specifications subject to change without notice. No license is granted by implication or otherwise under any patent or patent rights of Analog Devices. Trademarks and registered trademarks are the property of their respective owners.

TABLE OF CONTENTS

Features	1	Theory of Operation	11
Applications.....	1	Device Power Dissipation Considerations.....	11
Pin Configuration.....	1	Input Capacitor.....	11
General Description.....	1	Output Capacitor.....	11
Revision History	2	Applications Information	12
Specifications.....	3	Stacking Reference ICs for Arbitrary Outputs	12
ADR380 Electrical Characteristics.....	3	A Negative Precision Reference Without Precision Resistors	12
ADR381 Electrical Characteristics.....	4	Precision Current Source	12
Absolute Maximum Ratings.....	5	Precision High Current Voltage Source	13
Thermal Resistance	5	Outline Dimensions.....	14
ESD Caution.....	5	Ordering Guide	14
Typical Performance Characteristics	6		
Terminology	10		

REVISION HISTORY

10/10—Rev. B to Rev. C

Deleted Figure 32.....	14
Changes to Ordering Guide	14

1/09—Rev. A to Rev. B

Updated Format.....	Universal
Changes to Table 7.....	5
Changes to Stacking Reference ICs for Arbitrary Outputs Section, Figure 28, and Figure 29	12
Updated Outline Dimensions	14
Changes to Ordering Guide	14

7/04—Rev. 0 to Rev. A

Updated Format.....	Universal
Changes to Ordering Guide	16
Updated Outline Dimensions.....	16

SPECIFICATIONS

ADR380 ELECTRICAL CHARACTERISTICS

$V_{IN} = 5.0\text{ V}$, $T_A = 25^\circ\text{C}$, unless otherwise noted.

Table 2.

Parameter	Symbol	Conditions	Min	Typ	Max	Unit
Output Voltage	V_{OUT}		2.043	2.048	2.053	V
Initial Accuracy Error	V_{OERR}		-5		+5	mV
			-0.24		+0.24	%
Temperature Coefficient	TCV_{OUT}	$-40^\circ\text{C} < T_A < +85^\circ\text{C}$ $0^\circ\text{C} < T_A < 70^\circ\text{C}$		5	25	ppm/ $^\circ\text{C}$
				3	21	ppm/ $^\circ\text{C}$
Minimum Supply Voltage Headroom	$V_{IN} - V_{OUT}$	$I_{LOAD} \leq 3\text{ mA}$		300		mV
Line Regulation	$\Delta V_{OUT}/DV_{IN}$	$V_{IN} = 2.5\text{ V to }15\text{ V}$, $-40^\circ\text{C} < T_A < +85^\circ\text{C}$		10	25	ppm/V
Load Regulation	$\Delta V_{OUT}/DI_{LOAD}$	$V_{IN} = 3\text{ V}$, $I_{LOAD} = 0\text{ mA to }5\text{ mA}$, $-40^\circ\text{C} < T_A < +85^\circ\text{C}$			70	ppm/mA
Quiescent Current	I_{IN}	No load $-40^\circ\text{C} < T_A < +85^\circ\text{C}$		100	120	μA
					140	μA
Voltage Noise	e_N	0.1 Hz to 10 Hz		5		$\mu\text{V p-p}$
Turn-On Settling Time	t_R			20		μs
Long-Term Stability	ΔV_{OUT}	1000 Hrs		50		ppm
Output Voltage Hysteresis	V_{OUT_HYS}			40		ppm
Ripple Rejection Ratio	RRR	$f_{IN} = 60\text{ Hz}$		85		dB
Short Circuit to GND	I_{SC}			25		mA

$V_{IN} = 15.0\text{ V}$, $T_A = 25^\circ\text{C}$, unless otherwise noted.

Table 3.

Parameter	Symbol	Conditions	Min	Typ	Max	Unit
Output Voltage	V_{OUT}		2.043	2.048	2.053	V
Initial Accuracy Error	V_{OERR}		-5		+5	mV
			-0.24		+0.24	%
Temperature Coefficient	TCV_{OUT}	$-40^\circ\text{C} < T_A < +85^\circ\text{C}$ $0^\circ\text{C} < T_A < 70^\circ\text{C}$		5	25	ppm/ $^\circ\text{C}$
				3	21	ppm/ $^\circ\text{C}$
Minimum Supply Voltage Headroom	$V_{IN} - V_{OUT}$	$I_{LOAD} \leq 3\text{ mA}$		300		mV
Line Regulation	$\Delta V_{OUT}/DV_{IN}$	$V_{IN} = 2.5\text{ V to }15\text{ V}$, $-40^\circ\text{C} < T_A < +85^\circ\text{C}$		10	25	ppm/V
Load Regulation	$\Delta V_{OUT}/DI_{LOAD}$	$V_{IN} = 3\text{ V}$, $I_{LOAD} = 0\text{ mA to }5\text{ mA}$, $-40^\circ\text{C} < T_A < +85^\circ\text{C}$			70	ppm/mA
Quiescent Current	I_{IN}	No load $-40^\circ\text{C} < T_A < +85^\circ\text{C}$		100	120	μA
					140	μA
Voltage Noise	e_N	0.1 Hz to 10 Hz		5		$\mu\text{V p-p}$
Turn-On Settling Time	t_R			20		μs
Long-Term Stability	ΔV_{OUT}	1000 Hrs		50		ppm
Output Voltage Hysteresis	V_{OUT_HYS}			40		ppm
Ripple Rejection Ratio	RRR	$f_{IN} = 60\text{ Hz}$		85		dB
Short Circuit to GND	I_{SC}			25		mA

ADR380/ADR381

ADR381 ELECTRICAL CHARACTERISTICS

$V_{IN} = 5.0\text{ V}$, $T_A = 25^\circ\text{C}$, unless otherwise noted.

Table 4.

Parameter	Symbol	Conditions	Min	Typ	Max	Unit
Output Voltage	V_{OUT}		2.494	2.500	2.506	V
Initial Accuracy Error	V_{OERR}		-6		+6	mV
Temperature Coefficient	TCV_{OUT}	$-40^\circ\text{C} < T_A < +85^\circ\text{C}$ $0^\circ\text{C} < T_A < 70^\circ\text{C}$	-0.24	5	+0.24	%
Minimum Supply Voltage Headroom	$V_{IN} - V_{OUT}$	$I_{LOAD} \leq 2\text{ mA}$		3	25	ppm/ $^\circ\text{C}$
Line Regulation	$\Delta V_{OUT}/DV_{IN}$	$V_{IN} = 2.8\text{ V to } 15\text{ V}$, $-40^\circ\text{C} < T_A < +85^\circ\text{C}$		10	21	ppm/V
Load Regulation	$\Delta V_{OUT}/DI_{LOAD}$	$V_{IN} = 3.5\text{ V}$, $I_{LOAD} = 0\text{ mA to } 5\text{ mA}$, $-40^\circ\text{C} < T_A < +85^\circ\text{C}$			70	ppm/mA
Quiescent Current	I_{IN}	No load $-40^\circ\text{C} < T_A < +85^\circ\text{C}$		100	120	μA
Voltage Noise	e_N	0.1 Hz to 10 Hz		5	140	$\mu\text{V p-p}$
Turn-On Settling Time	t_R			20		μs
Long-Term Stability	ΔV_{OUT}	1000 Hrs		50		ppm
Output Voltage Hysteresis	V_{OUT_HYS}			75		ppm
Ripple Rejection Ratio	RRR	$f_{IN} = 60\text{ Hz}$		85		dB
Short Circuit to GND	I_{SC}			25		mA

$V_{IN} = 5.0\text{ V}$, $T_A = 25^\circ\text{C}$, unless otherwise noted.

Table 5.

Parameter	Symbol	Conditions	Min	Typ	Max	Unit
Output Voltage	V_{OUT}		2.494	2.500	2.506	V
Initial Accuracy Error	V_{OERR}		-6		+6	mV
Temperature Coefficient	TCV_{OUT}	$-40^\circ\text{C} < T_A < +85^\circ\text{C}$ $0^\circ\text{C} < T_A < 70^\circ\text{C}$	-0.24	5	+0.24	%
Minimum Supply Voltage Headroom	$V_{IN} - V_{OUT}$	$I_{LOAD} \leq 2\text{ mA}$		3	25	ppm/ $^\circ\text{C}$
Line Regulation	$\Delta V_{OUT}/DV_{IN}$	$V_{IN} = 2.8\text{ V to } 15\text{ V}$, $-40^\circ\text{C} < T_A < +85^\circ\text{C}$		10	21	ppm/V
Load Regulation	$\Delta V_{OUT}/DI_{LOAD}$	$V_{IN} = 3.5\text{ V}$, $I_{LOAD} = 0\text{ mA to } 5\text{ mA}$, $-40^\circ\text{C} < T_A < +85^\circ\text{C}$			70	ppm/mA
Quiescent Current	I_{IN}	No load $-40^\circ\text{C} < T_A < +85^\circ\text{C}$		100	120	μA
Voltage Noise	e_N	0.1 Hz to 10 Hz		5	140	$\mu\text{V p-p}$
Turn-On Settling Time	t_R			20		μs
Long-Term Stability	ΔV_{OUT}	1000 Hrs		50		ppm
Output Voltage Hysteresis	V_{OUT_HYS}			75		ppm
Ripple Rejection Ratio	RRR	$f_{IN} = 60\text{ Hz}$		85		dB
Short Circuit to GND	I_{SC}			25		mA

ABSOLUTE MAXIMUM RATINGS

Table 6.

Parameter ¹	Rating
Supply Voltage	18 V
Output Short-Circuit Duration to GND	
$V_{IN} > 15\text{ V}$	10 sec
$V_{IN} \leq 15\text{ V}$	Indefinite
Storage Temperature Range	-65°C to +150°C
Operating Temperature Range	-40°C to +85°C
Junction Temperature Range	-65°C to +150°C
Lead Temperature (Soldering, 60 Sec)	300°C

¹ Absolute maximum ratings apply at 25°C, unless otherwise noted.

Stresses above those listed under Absolute Maximum Ratings may cause permanent damage to the device. This is a stress rating only; functional operation of the device at these or any other conditions above those indicated in the operational section of this specification is not implied. Exposure to absolute maximum rating conditions for extended periods may affect device reliability.

THERMAL RESISTANCE

θ_{JA} is specified for the worst-case conditions, that is, a device soldered in a circuit board for surface-mount packages.

Table 7.

Package Type	θ_{JA}	Unit
3-Lead SOT-23 (RT)	333	°C/W

ESD CAUTION



ESD (electrostatic discharge) sensitive device. Charged devices and circuit boards can discharge without detection. Although this product features patented or proprietary protection circuitry, damage may occur on devices subjected to high energy ESD. Therefore, proper ESD precautions should be taken to avoid performance degradation or loss of functionality.

TYPICAL PERFORMANCE CHARACTERISTICS

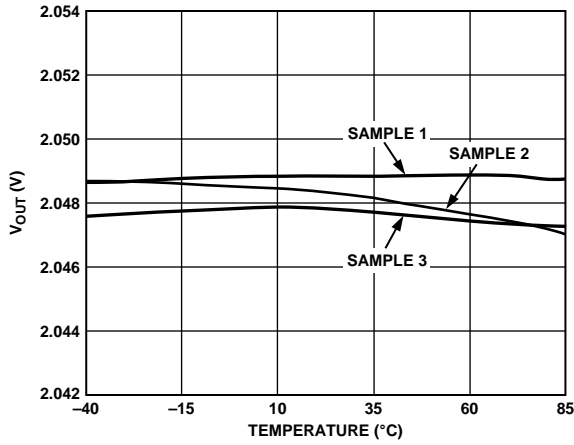

Figure 2. ADR380 Output Voltage vs. Temperature

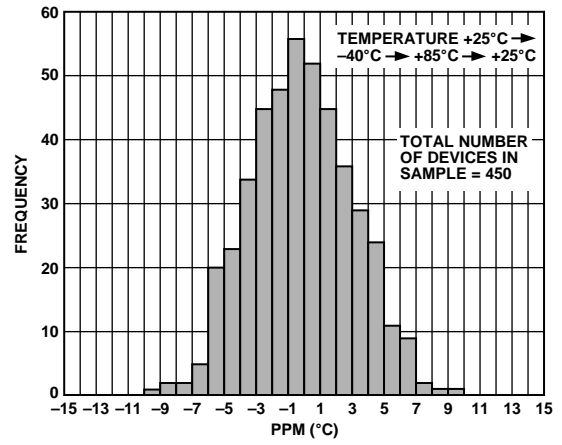

Figure 5. ADR381 Output Voltage Temperature Coefficient

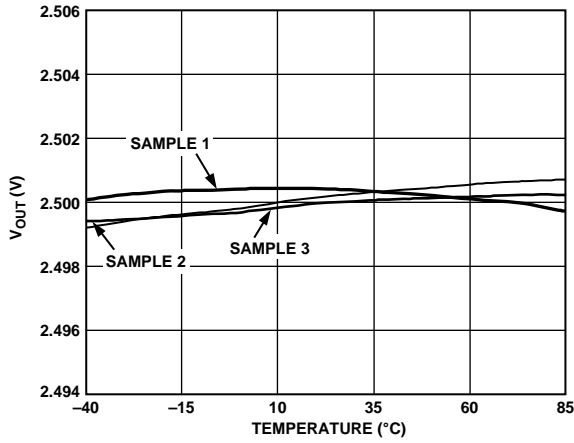

Figure 3. ADR381 Output Voltage vs. Temperature

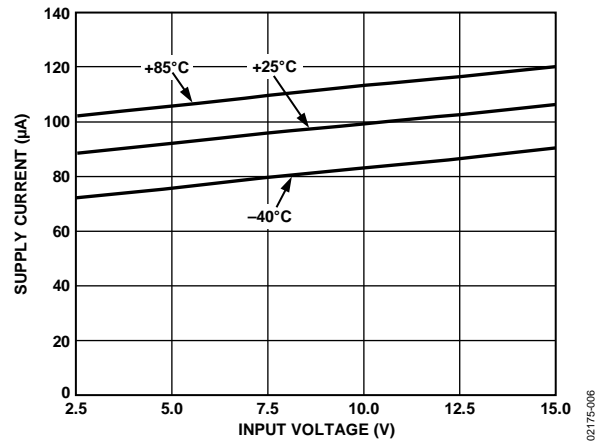

Figure 6. ADR380 Supply Current vs. Input Voltage

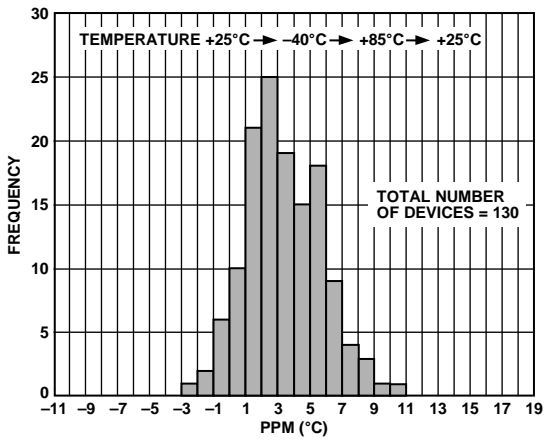

Figure 4. ADR380 Output Voltage Temperature Coefficient

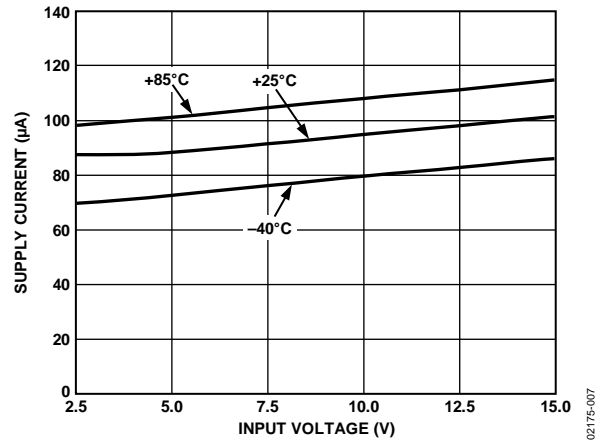

Figure 7. ADR381 Supply Current vs. Input Voltage

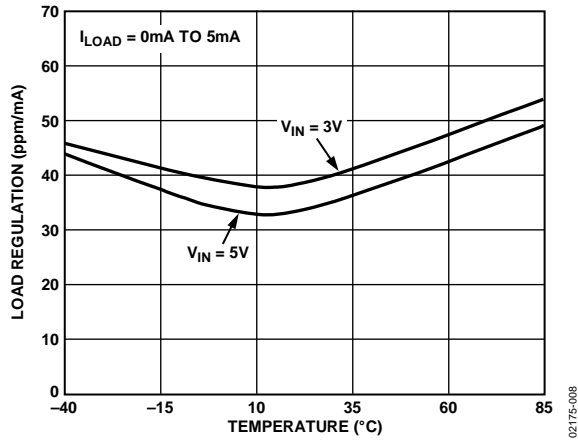

Figure 8. ADR380 Load Regulation vs. Temperature

02175-008

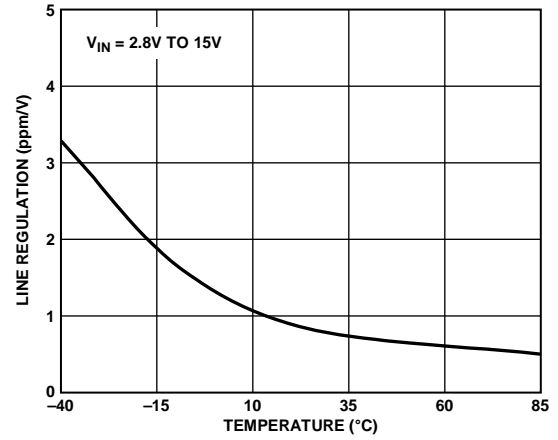

Figure 11. ADR381 Line Regulation vs. Temperature

02175-011

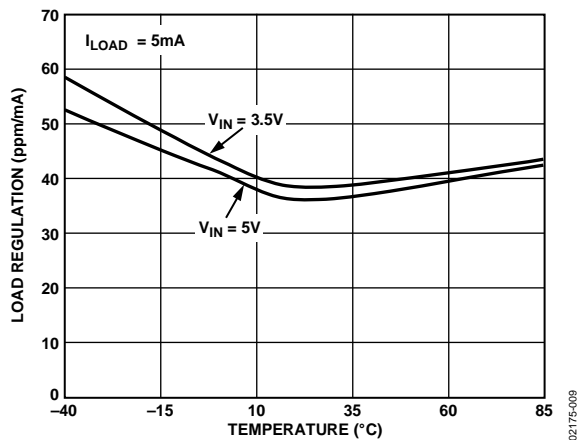

Figure 9. ADR381 Load Regulation vs. Temperature

02175-009

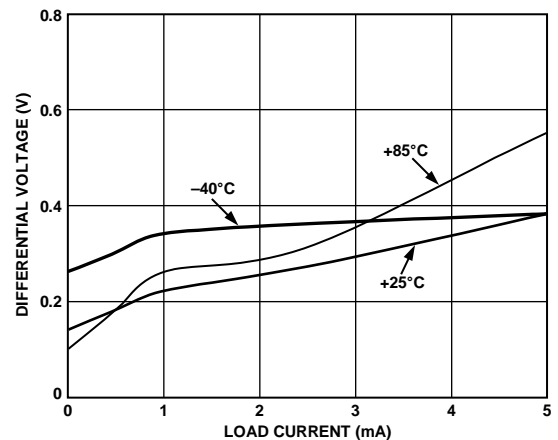

Figure 12. ADR380 Minimum Input/Output Differential Voltage vs. Load Current

02175-012

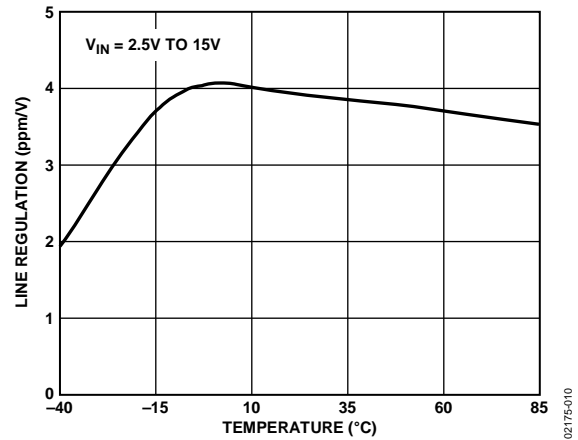

Figure 10. ADR380 Line Regulation vs. Temperature

02175-010

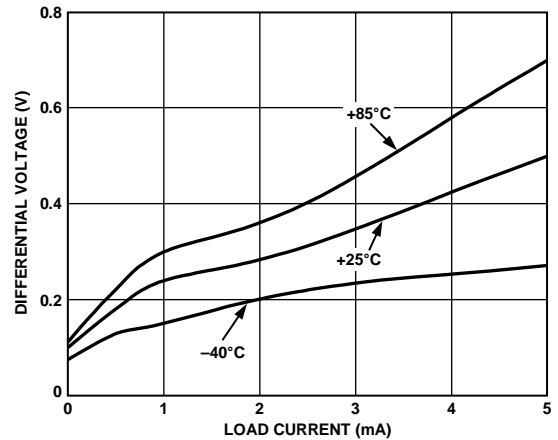

Figure 13. ADR381 Minimum Input/Output Differential Voltage vs. Load Current

02175-013

ADR380/ADR381

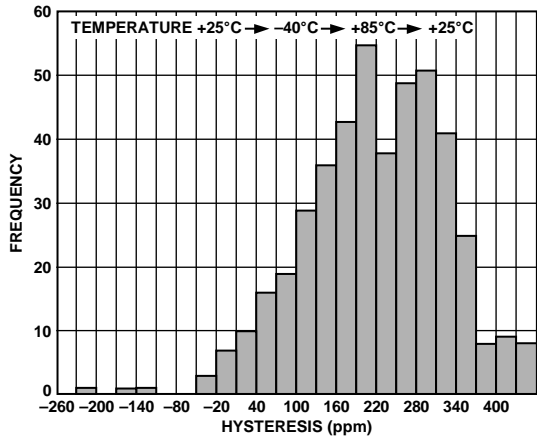

Figure 14. ADR381 V_{OUT} Hysteresis

02175-014

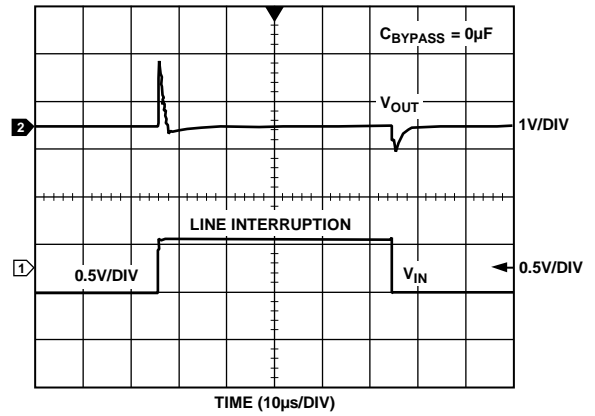

Figure 17. ADR381 Line Transient Response

02175-017

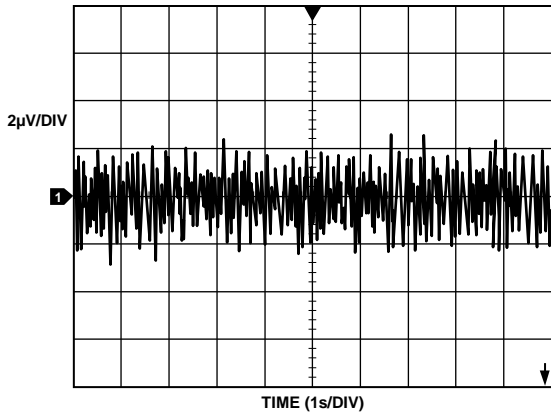

Figure 15. ADR381 Typical Noise Voltage, 0.1 Hz to 10 Hz

02175-015

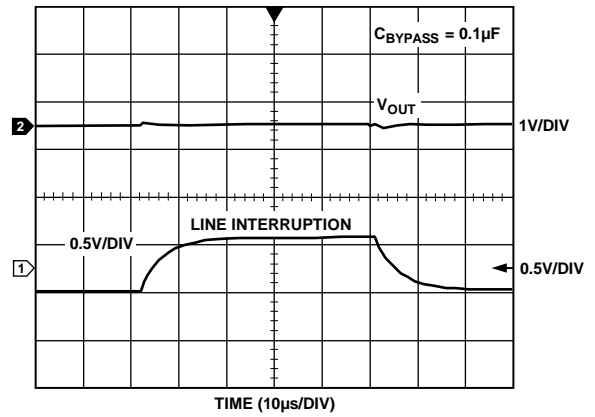

Figure 18. ADR381 Line Transient Response

02175-018

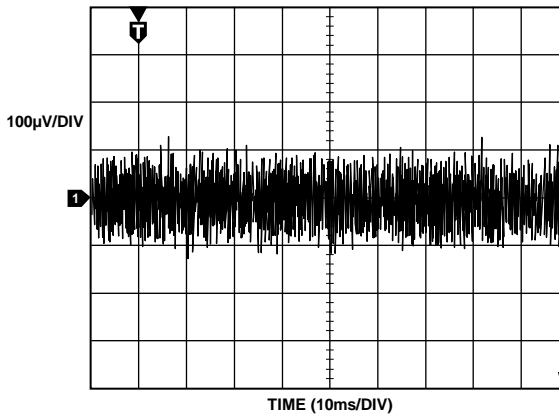

Figure 16. ADR381 Typical Noise Voltage, 10 Hz to 10 kHz

02175-016

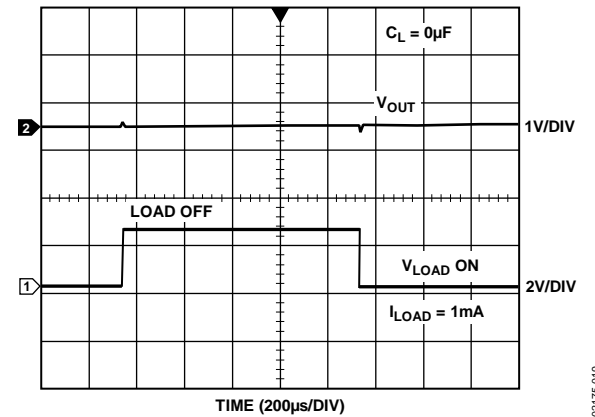

Figure 19. ADR381 Load Transient Response with $C_L = 0 \mu F$

02175-019

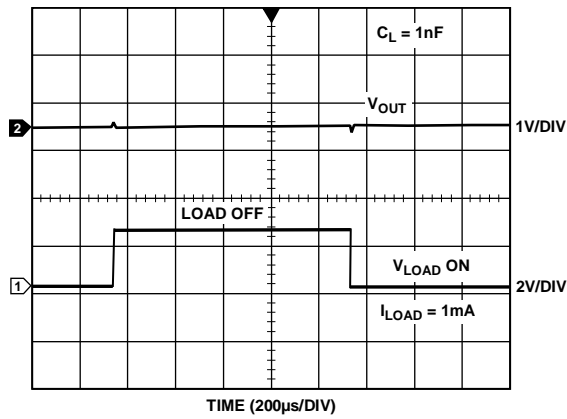

Figure 20. ADR381 Load Transient Response with $C_L = 1\text{ nF}$

02175-020

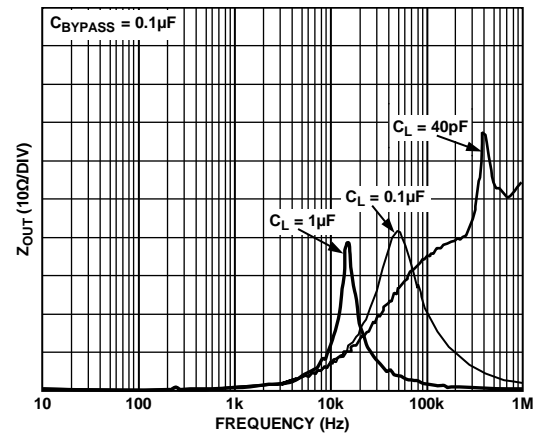

Figure 23. ADR381 Output Impedance vs. Frequency

02175-023

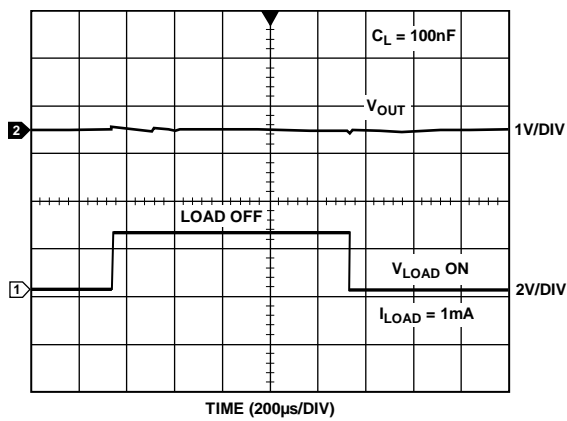

Figure 21. ADR381 Load Transient Response with $C_L = 100\text{ nF}$

02175-021

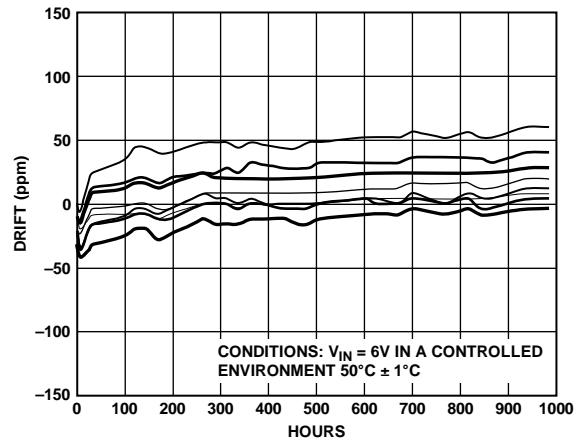

Figure 24. ADR380 Long-Term Drift

02175-024

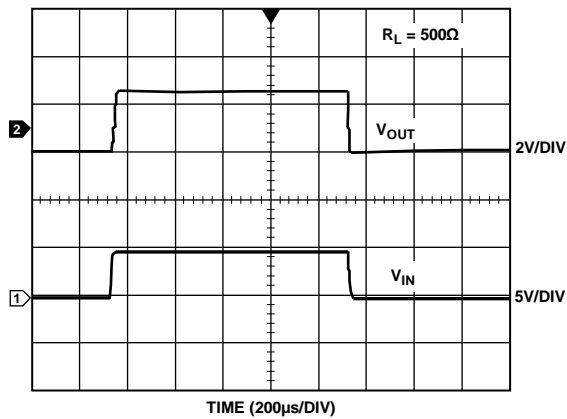

Figure 22. ADR381 Turn-On/Turn-Off Response at 5 V

02175-022

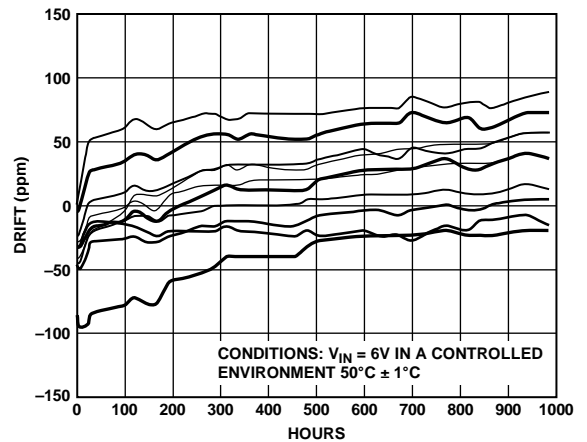

Figure 25. ADR381 Long-Term Drift

02175-025

TERMINOLOGY

Temperature Coefficient

The change of output voltage over the operating temperature change and normalized by the output voltage at 25°C, expressed in ppm/°C. The equation follows:

$$TCV_{OUT}[\text{ppm}/^{\circ}\text{C}] = \frac{V_{OUT}(T_2) - V_{OUT}(T_1)}{V_{OUT}(25^{\circ}\text{C}) \times (T_2 - T_1)} \times 10^6$$

where:

$V_{OUT}(25^{\circ}\text{C}) = V_{OUT}$ at 25°C.

$V_{OUT}(T_1) = V_{OUT}$ at Temperature 1.

$V_{OUT}(T_2) = V_{OUT}$ at Temperature 2.

Line Regulation

The change in output voltage due to a specified change in input voltage. It includes the effects of self-heating. Line regulation is expressed in either percent per volt, parts-per-million per volt, or microvolts per volt change in input voltage.

Load Regulation

The change in output voltage due to a specified change in load current. It includes the effects of self-heating. Load regulation is expressed in either microvolts per milliamper, parts-per-million per milliamper, or ohms of dc output resistance.

Long-Term Stability

A typical shift in output voltage over 1000 hours at a controlled temperature. Figure 24 and Figure 25 show a sample of parts measured at different intervals in a controlled environment of 50°C for 1000 hours.

$$\Delta V_{OUT} = V_{OUT}(t_0) - V_{OUT}(t_1)$$

$$\Delta V_{OUT}[\text{ppm}] = \frac{V_{OUT}(t_0) - V_{OUT}(t_1)}{V_{OUT}(t_0)} \times 10^6$$

where:

$V_{OUT}(t_0) = V_{OUT}$ at Time 0.

$V_{OUT}(t_1) = V_{OUT}$ after 1000 hours of operation at a controlled temperature.

Note that 50°C was chosen because most applications run at a higher temperature than 25°C.

Thermal Hysteresis

The change of output voltage after the device is cycled through temperature from +25°C to -40°C to +85°C and back to +25°C. This is a typical value from a sample of parts put through such a cycle.

$$V_{OUT_HYS} = V_{OUT}(25^{\circ}\text{C}) - V_{OUT_TC}$$

$$V_{OUT_HYS}[\text{ppm}] = \frac{V_{OUT}(25^{\circ}\text{C}) - V_{OUT_TC}}{V_{OUT}(25^{\circ}\text{C})} \times 10^6$$

where:

$V_{OUT}(25^{\circ}\text{C}) = V_{OUT}$ at 25°C.

$V_{OUT_TC} = V_{OUT}$ at 25°C after a temperature cycle from +25°C to -40°C to +85°C and back to +25°C.

PRECISION HIGH CURRENT VOLTAGE SOURCE

In some cases, the user may want higher output current delivered to a load and still achieve better than 0.5% accuracy from the ADR380/ADR381. The accuracy for a reference is normally specified on the data sheet with no load. However, the output voltage changes with load current.

The circuit in Figure 30 provides high current without compromising the accuracy of the ADR380/ADR381. By op amp action, V_{OUT} follows V_{REF} with very low drop in $R1$. To maintain circuit equilibrium, the op amp also drives the N-Channel MOSFET Q1 into saturation to maintain the current needed at different loads. $R2$ is optional to prevent oscillation at Q1. In such an approach, hundreds of milliamps of load current can be achieved, and the current is limited by the thermal limitation of Q1. $V_{IN} = V_{OUT} + 300 \text{ mV}$.

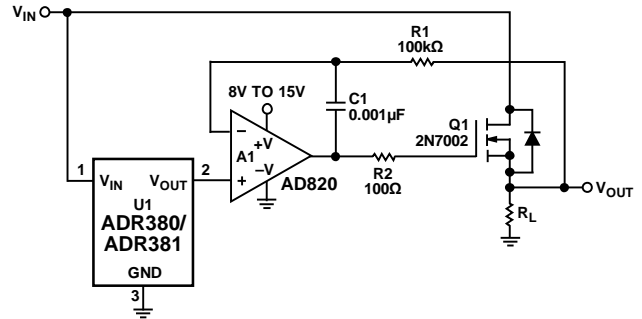
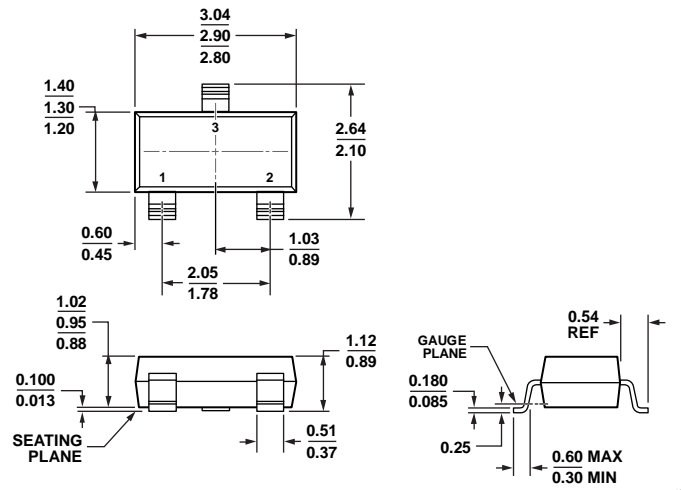

Figure 30. ADR380/ADR381 for Precision High Current Voltage Source

02175-030

OUTLINE DIMENSIONS



COMPLIANT TO JEDEC STANDARDS TO-236-AB

Figure 31. 3-Lead Small Outline Transistor Package [SOT-23-3] (RT-3)

Dimensions shown in millimeters

011909-C

ORDERING GUIDE

Model ¹	Temperature Range	Package Description	Package Option	Branding ²	Output Voltage	Ordering Quantity
ADR380ARTZ-REEL7	-40°C to +85°C	3-Lead SOT-23	RT-3	R2D	2.048	3,000
ADR381ARTZ-R2	-40°C to +85°C	3-Lead SOT-23	RT-3	R3A	2.500	250
ADR381ARTZ-REEL7	-40°C to +85°C	3-Lead SOT-23	RT-3	R3A#	2.500	3,000

¹ Z = RoHS Compliant Part, # denotes RoHS compliant product may be top or bottom marked.

² Prior to Date Code 0542, the ADR380ARTZ-REEL7 parts were branded with R2A without the #.

NOTES

NOTES

Looking for pricing, stock, or lifecycle information?

Click below to explore more details on WIN SOURCE:

 [View ADR381ART-REEL7 on WIN SOURCE](#)

 [Analog Devices Inc. Information](#)

Optimize Your Supply Chain with WIN SOURCE Solutions

-  Global Sourcing Solution
-  Obsolete Management
-  Cost Control Management
-  Shortage Management
-  Alternative Solution
-  Excess Inventory Management