



THE DATASHEET OF FAN5608DHMPX



FAN5608

Serial/Parallel LED Driver with Current-Regulated, Step-Up DC/DC Converter

Features

- Two Independent Channels Drive up to Six LEDs per Channel
- Adaptive Output Voltage Drive to Maximize Efficiency
- PWM/PFM Mode of Operation of the boost circuit
- Up to 85% Efficiency
- Up to 2 × 20mA Output
- Two Built-in DACs for Independent (Digital) Brightness Control for Both Channels
- LED's Current Can be Duty-Cycle-Modulated between 0 to 20mA
- Digital, analog, and PWM brightness control
- 2.7V to 5V Input Voltage Range
- 0.5MHz Operating Frequency (8MHz internal clock)
- Soft Start
- Low Shutdown Current: $I_{CC} < 1\mu A$
- LED Short Circuit Protection
- Minimal External Components Needed
- Available in an 8-lead MLP and a 12-lead MLP Package

Description

The FAN5608 LED driver generates regulated output currents from a battery with input voltage varying between 2.7V to 5V. An internal NMOS switch drives an external inductor, and a Schottky diode delivers the inductor's stored energy to the load. Proprietary internal circuitry continuously monitors each LED current string and automatically adjusts the generated output DC voltage to the lowest minimum value required by the LED's string with the highest summarized forward voltage. This adaptive nature of the FAN5608 ensures operation at the highest possible efficiency. Soft start circuitry prevents excessive current drawn from the supply during power on. Any number of LEDs can be connected in series as long as the summed forward voltages do not lead to exceeding the specified operating output voltage range. Although it is not required to have an equal number of LEDs connected in series within each branch, the highest efficiency and best current regulation is always achieved when an equal number of LEDs are serially connected.

Applications

- Cell Phones
- Handheld Computers
- PDAs, DSCs, MP3 Players
- Keyboard Backlights
- LED Displays

In the FAN5608 device, two internal two-bit D/A converters provide independent programmability of each output channel current. Analog programming of the output current is also possible in the FAN5608. To do this, ground the "B" pins and connect a resistor between the "A" pins and a fixed supply

Typical Application

Analog or Digital Brightness Control

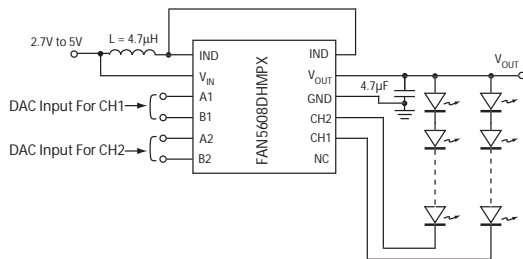

4X4mm MLP-12 Package
with internal Schottky diode
Order Code: FAN5608DHMPX

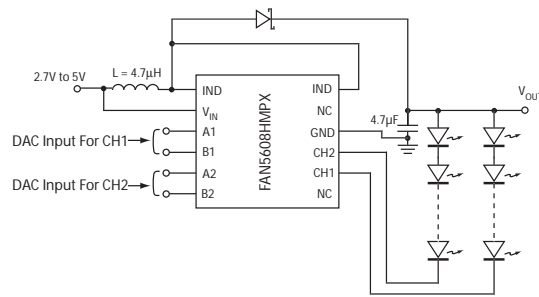

4X4mm MLP-12 Package
with external Schottky diode
Order Code: FAN5608HMPX

voltage. The output current can then be programmed to any desired value within its specified range. The FAN5608DMPX/FAN5608MPX version uses a single external resistor to set the current, and to turn the device ON and OFF. The FAN5608DMPX/FAN5608MPX is available in an

8-lead MLP package with or without an internal Schottky diode. The FAN5608DHMPX is available in a 12-lead MLP package with an internal Schottky diode.

Typical Application (Continued)

Analog Brightness Control

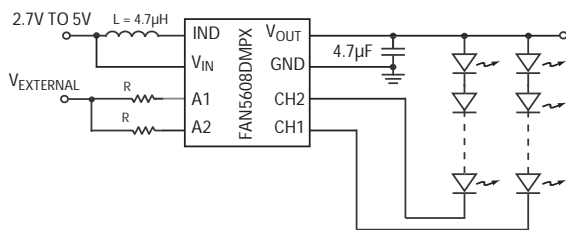

**3X3mm MLP-8 Package
with internal Schottky diode
Order Code: FAN5608DMPX**

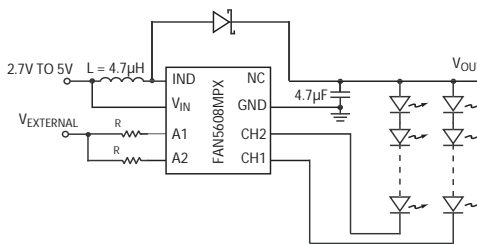

**3X3mm MLP-8 Package
with external Schottky diode
Order Code: FAN5608MPX**

Definition of Terms

Output Current Accuracy: reflects the difference between the measured value of the output current (LED) and programmed value of this current.

$$\text{Output Current Accuracy (\%)} = \frac{(I_{\text{OUT measured}} - I_{\text{OUT programmed}}) \times 100}{I_{\text{OUT programmed}}}$$

Current Matching: refers to the absolute value of difference in current between the two LED branches.

$$\text{Current Matching (\%)} = \left| \frac{(I_{\text{LED branch 1}} - I_{\text{LED branch 2}}) \times 100}{(I_{\text{LED branch 1}} + I_{\text{LED branch 2}}) / 2} \right|$$

Efficiency: is expressed as a ratio between the electrical power into the LEDs and the total power consumed from the input power supply.

$$\text{Efficiency (\%)} = \frac{(V_{\text{LED branch 1}} \times I_{\text{LED branch 1}} + V_{\text{LED branch 2}} \times I_{\text{LED branch 2}}) \times 100}{V_{\text{IN}} \times I_{\text{IN}}}$$

Although this definition leads to a lower value than the boost converter efficiency, it more accurately reflects better system performance, from the user's point-of-view.

Pin Assignments

TOP-VIEW

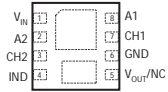

3x3mm 8-Lead MLP
(Internal Schottky Diode)

FAN5608DMPX/FAN5608MPX

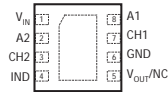

3x3mm 8-Lead MLP
(External Schottky Diode)

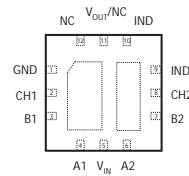

4x4mm 12-Lead MLP(QUAD)
(Internal Schottky Diode)

FAN5608DHMPX/FAN5608HMPX

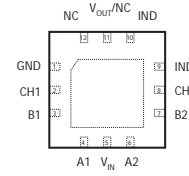

4x4mm 12-Lead MLP(QUAD)
(External Schottky Diode)

Pin Descriptions

Pin No.	Pin Name				Pin Function Description
	FAN5608DHMPX	FAN5608HMPX	FAN5608DMPX	FAN5608MPX	
1	GND	GND	GND	GND	Ground
			V _{IN}	V _{IN}	Input Voltage
2	CH1	CH1			1st LED Cathode
			A2	A2	DAC A2
3	B1	B1			DAC B1
			CH2	CH2	2nd LED Cathode
4	A1	A1			DAC A1
			IND	IND	Inductor
5	V _{IN}	V _{IN}			Input Voltage
			V _{OUT}		Output LEDs Anode
				NC	No Connection
6	A2	A2			DAC A2
			GND	GND	Ground
7	B2	B2			DAC B2
			CH1	CH1	1st LED Cathode
8	CH2	CH2			2nd LED Cathode
			A1	A1	DAC A1
9	IND	IND			Inductor
10	IND	IND			Inductor
11	V _{OUT}				Output LEDs Anode
		NC			No Connection
12	NC	NC			No Connection

Absolute Maximum Ratings

Parameter	Min	Typ	Max	Unit
V_{IN} , A, B Voltage to GND	-0.3		6	V
V_{OUT} , CH1, CH2 Voltage to GND	-0.3		24	V
Any LED Short Circuit Duration (Anode to Cathode)			Indefinite	
Lead Soldering Temperature (10 seconds)			300	°C
Thermal Resistance θ_{jc}		8		°C/W
Operating Junction Temperature Range			150	°C
Storage Temperature Range	-55		150	°C
Electrostatic Discharge (ESD) Protection (Note 1, 2)	HBM	4		kV
	CDM	1		

DC Electrical Characteristics

(V_{IN} = 2.7V to 5V, T_A = 25 °C, unless otherwise noted. Boldface values indicate specifications over the ambient operating temperature.)

Parameter	Conditions	Min.	Typ.	Max.	Units
Output Current Accuracy	A = HIGH, B = HIGH	$0.9 \times I_{NOM}$	$I_{NOM} = 20$	$1.1 \times I_{NOM}$	mA
Channel to Channel Current Matching	A = HIGH, B = HIGH			3	%
Efficiency (AVG)	$V_{IN} > 3.0V$		80		%
Switching Frequency			0.5		MHz
Multiplication Ratio	FAN5608DMPX/ FAN5608MPX	900	1000	1100	
	FAN5608DHMPX/ FAN5608HMPX	850	1000	1150	
Supply Current in OFF mode	$V_A = V_B = 0V$		0.1		μA
Input A1, A2 Threshold	Digital Mode	High	$V_{IN} - 0.7$	V_{IN}	V
		Low	0	0.6	
	Analog Mode		1.2		
Input B Threshold	Digital Mode	High	$0.6 \times V_{IN}$	V_{IN}	V
		Low	0	$0.3 \times V_{IN}$	

Recommended Operating Conditions

Parameter	Min	Typ	Max	Unit
Input Voltage Range	2.7		5	V
Operating Ambient Temperature Range	-40	25	85	°C
Output Voltage Range	V_{IN}		18	V

Notes:

- Using Mil Std. 883E, method 3015.7(Human Body Model) and EIA/JESD22C101-A (Charge Device Model).
- Avoid positive polarity ESD stress at the cathode of the internal Schottky diode.

Block Diagram

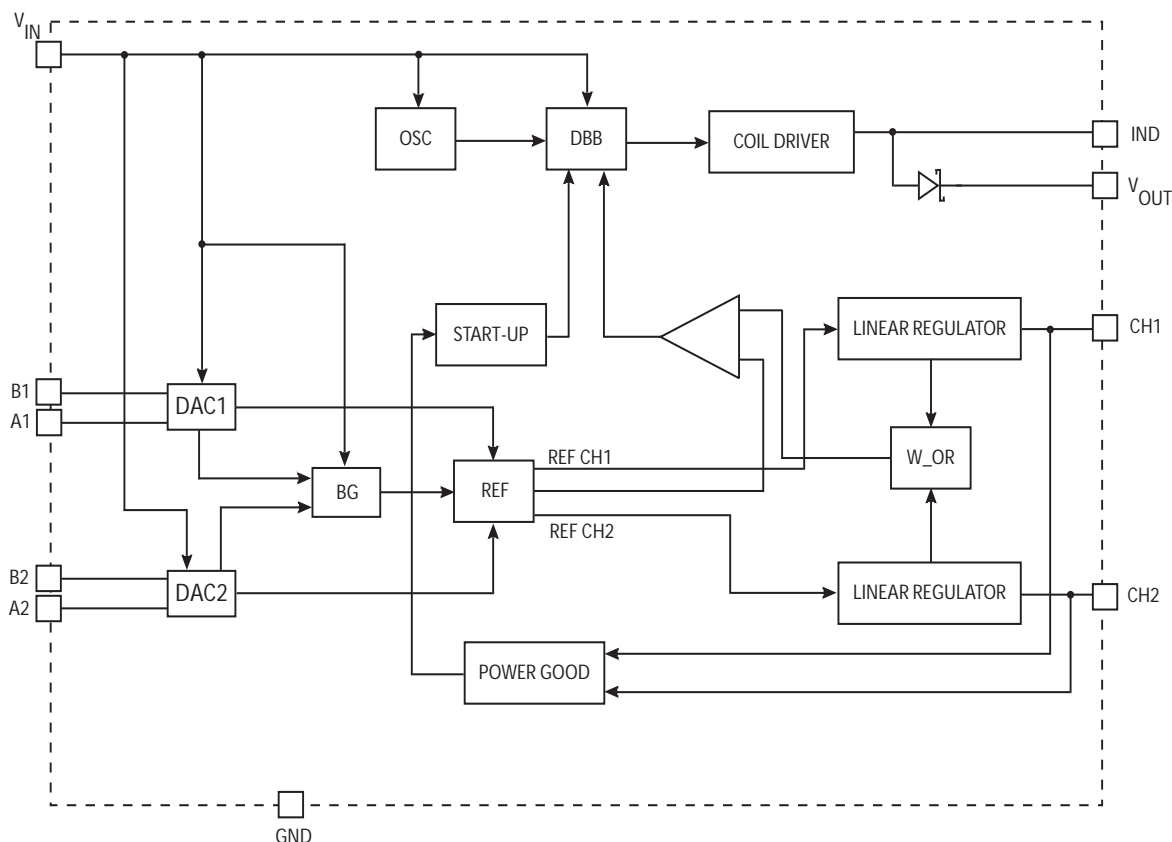

Note: In the 8-pin version (analog version only), pins B1 and B2 are omitted.

Circuit Description

When the input voltage is connected to V_{IN} pin, the system is turned on, the bandgap reference acquires its nominal voltage and the soft-start cycle begins. Once "power good" is achieved (0.5mA in the diodes), the soft-start cycle stops and the boost voltage increases to generate the desired current selected by the input control pins. If the second channel is not selected, its output will go high to about V_{IN} , and the diodes are turned off.

The FAN5608 DC/DC converter automatically adjusts its internal duty cycle to achieve high efficiency. It provides tightly regulated output currents for the LEDs. An internal circuit determines which LED string requires the highest voltage in order to sustain the pre-set current levels, and adjusts the boost regulator accordingly.

To maintain the regulated current at the selected value, the difference in the number of LEDs between branches should not exceed two. If only one branch is used, another branch should be disabled, connecting the corresponding DAC inputs to low. If the output external capacitor is shorted, the Schottky diode can be damaged, therefore such condition should be avoided.

LED Brightness Control

The control inputs are A1, B1 for CH1 and A2, B2 for CH2. B1 and B2 are digital inputs, thus they require LOW (GND) and HIGH (V_{CC}) control signals. In analog mode, A1 and A2 are connected to an external stable voltage source via an external resistor, and B1 and B2 inputs are connected to ground. The current flowing through the resistor is scaled by a factor of approximately 1000.

Digital Control

The FAN5608's digital decoder allows selection of the following modes of operation: OFF, 5mA, 10mA, 20mA per branch.

A	0	1	0	1
B	0	0	1	1
I _{LED}	OFF	5mA	10mA	20mA

Analog Control with PWM

Inputs A1 and A2 are used to control the LED currents. Inputs B1 and B2 should be connected to GND (logic level "0"). An external resistor (R) is connected from A1 and/or A2 to a stable voltage source (V_{EXTERNAL}) to control the LED current, I_{LED}. The formula used to calculate I_{LED} is as follows:

$$I_{LED} = \left(\frac{V_{External} - V_{Ref}}{R} \right) \times 1000$$

Where V_{Ref} = 1.22V

Pulse-Width-Modulation (PWM) Control

A variable duty cycle(δ) can modulate any DAC input. Care should be taken to not use a too low frequency, otherwise a flickering effect may occur. The minimum range is 100Hz to 1KHz. For a maximum range of LED current, both A and B inputs can be modulated at the same time.

No Load Protection

A built-in over voltage protection circuit prevents the device from being damaged when it is powered up with no load. This circuit reduces the boost converter duty cycle, to a minimum thus limiting the output voltage to a safe value when no load condition is detected. If one of the two enable branches is accidentally disconnected, the converter continues the operation, however, the current in the remaining branch is no longer regulated and the actual branch current will be determined by the input voltage, the inductor value and the switching frequency.

However, the FAN5608 can be damaged when a full load (more than six LEDs, driven by 20mA) is suddenly disconnected from V_{OUT}. To protect the FAN5608 against this unlikely event, an external 20V Zener diode can be connected between V_{OUT} and GND.

Shutdown Mode

Each branch can be independently disabled by applying LOW logic level voltage to the A and B inputs. When both branches are disabled, the FAN5608 enters Shutdown mode and the supply current is reduced to less than 1µA.

PWM Control

1. A is PWM Controlled, B is Low. I_{LED} (Average) = δ x 5mA, where δ is Duty Cycle. (Note 3)

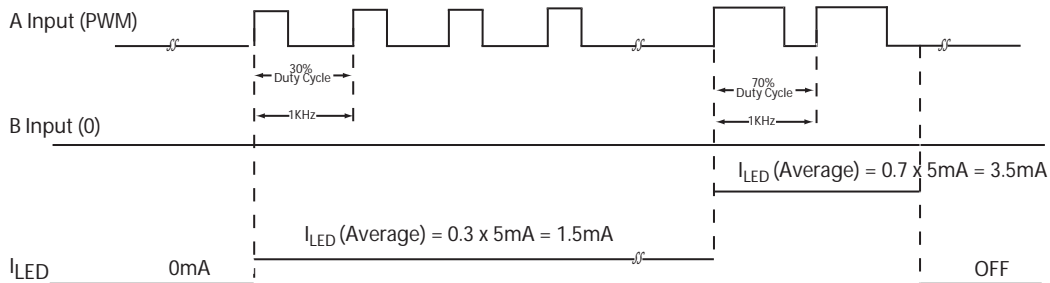

Note:

3. Proportionally select the duty cycle to achieve a typical LED current between 1mA to 4mA.

PWM Control (Continued)

2. A is High and B is PWM. $I_{LED} (Average) = 5mA + \delta \times 15mA$, where δ is Duty Cycle.(Note 4, 5)

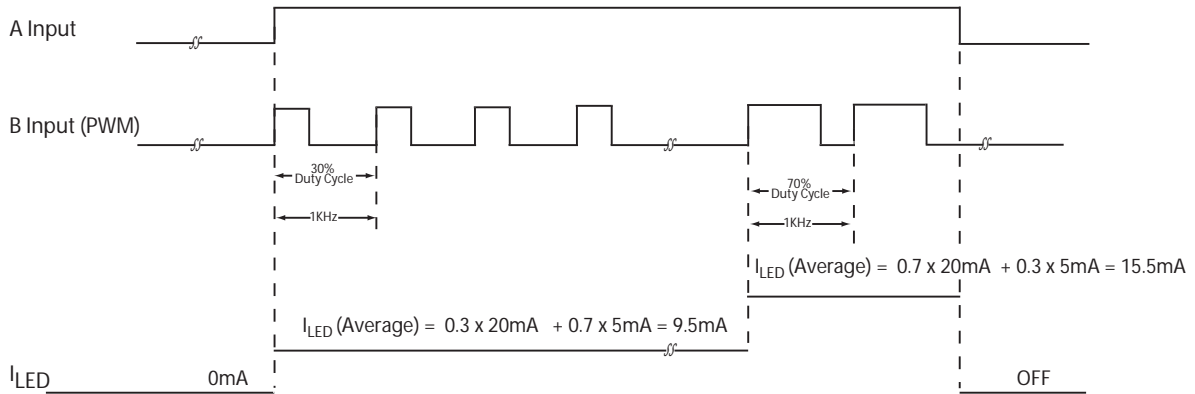

3. A and B are PWM. $I_{LED} (Average) = \delta \times 20mA$, where δ is Duty Cycle.(Note 4)

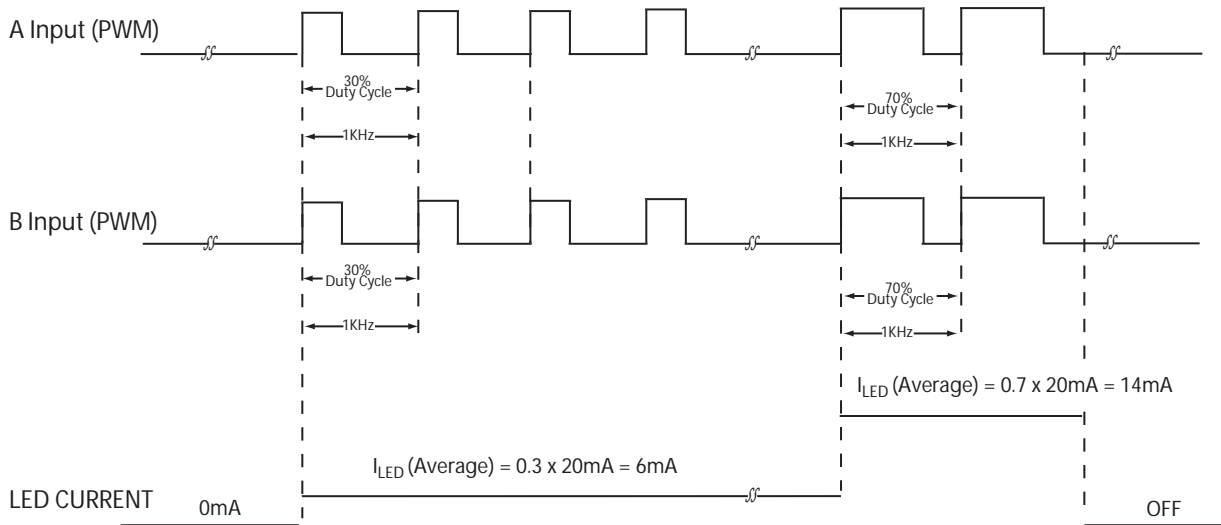

Notes:

- 4. Maximum PWM frequency can be up to 30KHz.
- 5. Proportionally select the duty cycle to achieve a typical LED current between 1mA and 19mA.

Applications Information

Inductor Selection

The inductor is one of the main components required by the boost converter to store energy. The amount of energy stored in the inductor and transferred to the load is controlled by the regulator using PWM and pulse skipping techniques. FAN5608 operates the inductor in discontinuous conduction mode in most cases.

To ensure proper operation of the current regulator over the entire range of conditions, the inductor should be selected based on the maximum required power (P_{OUT}) and the minimum input voltage (V_{IN}).

$$L < \frac{(V_{IN})^2 \times F}{P_{OUT}}$$

where units of L , V_{IN} , and P_{OUT} are in μH , Volt, and Watt, respectively $F = 0.4$ is a factor depending upon the FAN5608 architecture.

The above relation is applicable up to $P_{OUT} = 0.6\text{W}$ and $L = 4.3\mu\text{H}$, or greater. At lower inductor value the efficiency decreases due to the resistive loss in the switching Power FET. Using $L = 4.3\mu\text{H}$ and increasing the load to 12 LED x 20mA ($P_{OUT} = 800\text{mW}$) requires $V_{IN} > 3.5\text{V}$ to maintain a constant 20mA current through LEDs. The inductor $L = 4.3\mu\text{H}$ ensures proper operation for 2 x 4 white LEDs with 20mA at 3.5V for $V_{IN} > 2.8\text{V}$.

For any lighter load or higher V_{IN} , the inductance can be increased to improve the system efficiency. Application examples are given in Figure 1 through Figure 4.

The peak current in the inductor is:

$$I = \frac{T_{ON_Max} \times V_{IN_Max}}{L}$$

which gives the maximum rated current for the inductor. For $L = 4.3\mu\text{H}$, $T_{ON_Max} = 1.25\mu\text{s}$ and $V_{IN_Max} = 4.2\text{V}$, the inductor saturation current should be at least 1A.

Capacitor Selection

Low ESR capacitors should be used to minimize the input and output ripple voltage. Use of $C_{IN} = 4.7\mu\text{F}/6.3\text{V}$ and $C_{OUT} = 4.7\mu\text{F}/25\text{V}$ type X5R/X7R multi layer ceramic capacitor is recommended.

A larger value input capacitor placed as close as possible to FAN5608 may be needed to reduce the input voltage ripple in noise sensitive applications. An additional LC filter between the battery and the FAN5608 input can help to further reduce the battery ripple to the level required by a particular application.

PCB Layout Consideration

The FAN5608 is available in both a single Die Attach Pad (DAP) and a dual DAP package. In the single DAP package, DAP is connected to GND. In the dual DAP package, one DAP is connected to GND and another to V_{OUT} , therefore it is not necessary to provide any external connection to the DAPs. Since the internal power dissipation is low, both the 3x3mm and 4x4mm MLP packages are capable of dissipating maximum power, without providing any PCB land pattern. When viewing the bottom of the package of a single DAP device, a single exposed metal island can be seen; when viewing the bottom of the package of a dual DAP device, two electrically isolated exposed metal islands can be seen.

Application Examples

1. Driver For Four White LEDs

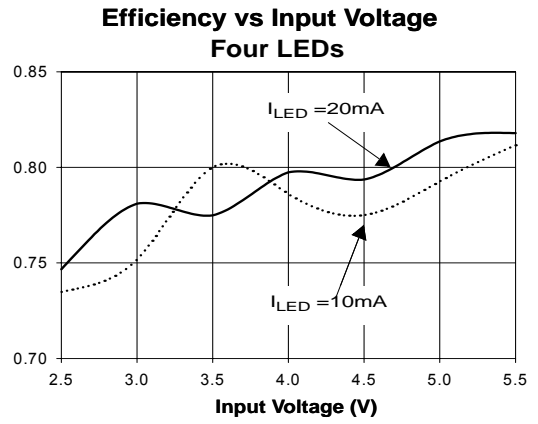
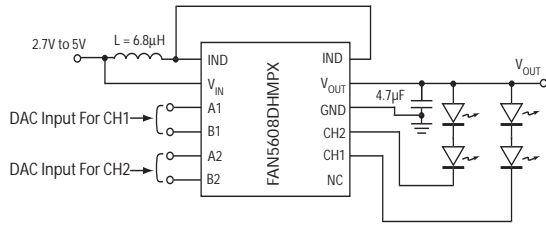

Figure 1

2. Driver For Six White LEDs

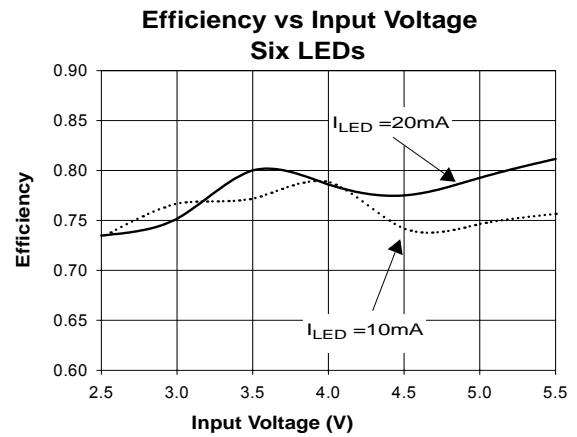
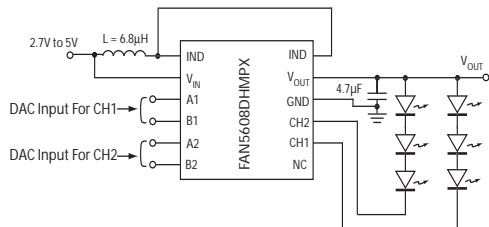

Figure 2

3. Driver For Eight White LEDs

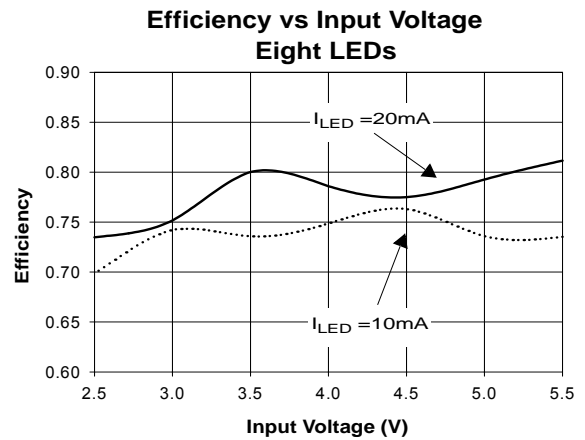
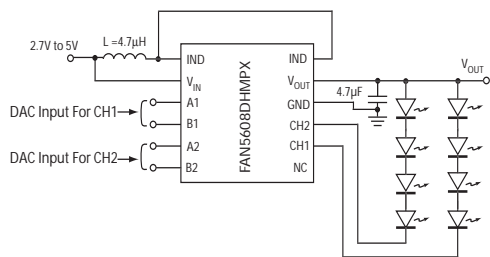

Figure 3

4. Driver For Twelve White LEDs

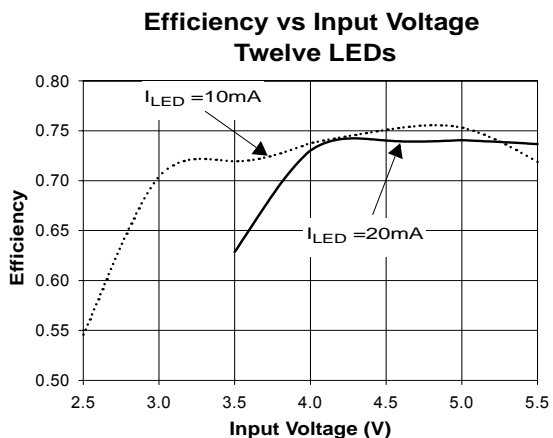
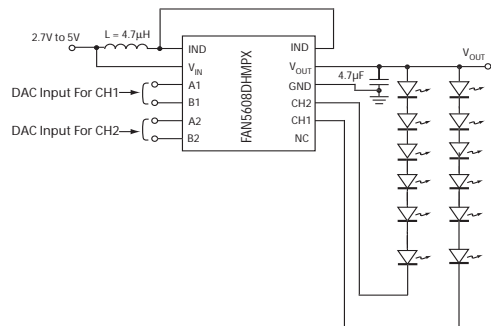

Figure 4

Note:

Refer to the Application Information, if higher load current compliance rating is required

Mechanical Dimensions

3x3mm 8-Lead MLP (Internal Schottky Diode)

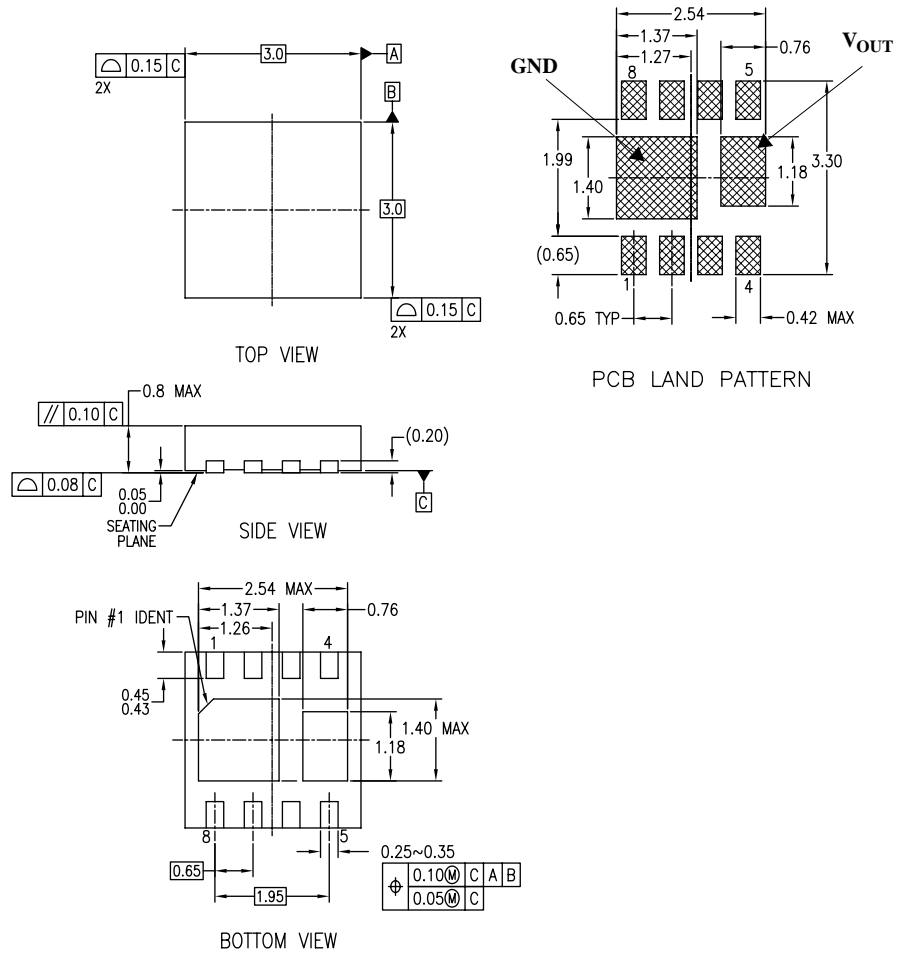

NOTES:

- A. CONFORMS TO JEDEC REGISTRATION MO-229, DATED 11/2001
- B. DIMENSIONS ARE IN MILLIMETERS.
- C. DIMENSIONS AND TOLERANCES PER ASME Y14.5M, 1994

Mechanical Dimensions

3x3mm 8-Lead MLP (External Schottky Diode)

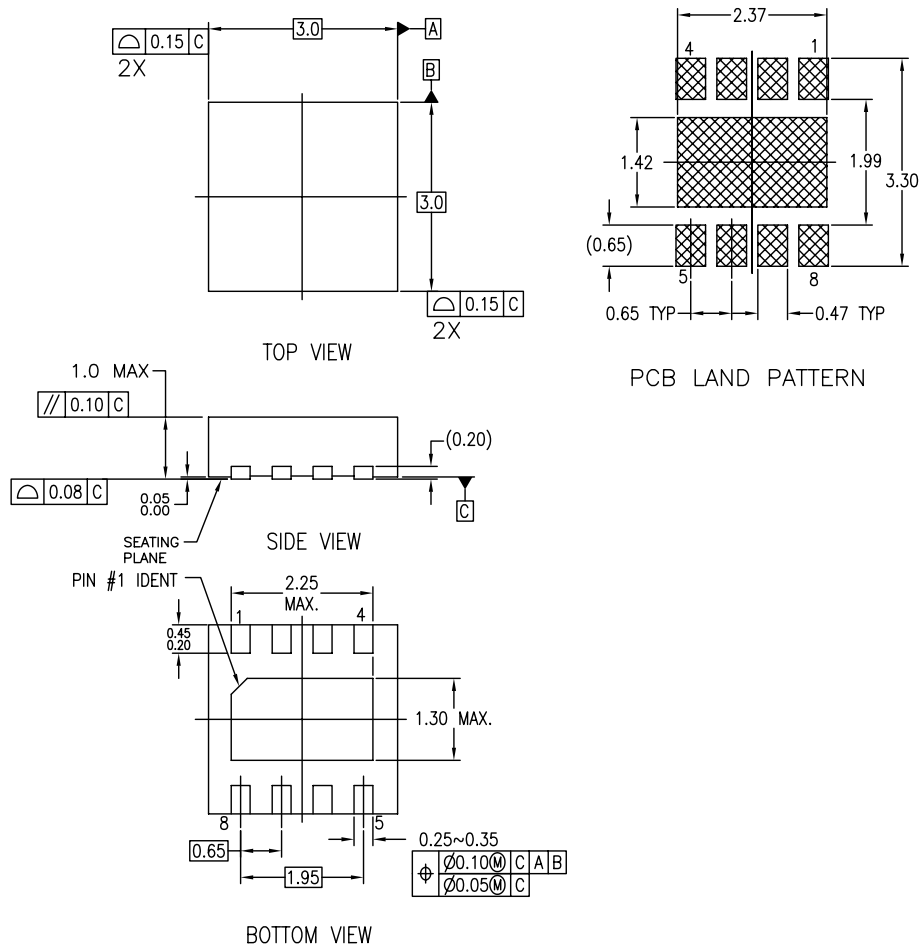

NOTES:

- A. CONFORMS TO JEDEC REGISTRATION MO-229, VARIATION VEEC, DATED 11/2001
- B. DIMENSIONS ARE IN MILLIMETERS.
- C. DIMENSIONS AND TOLERANCES PER ASME Y14.5M, 1994

Ordering Information

Product Number	Package Type	Schottky Diode	Order Code
FAN5608	12-Lead MLP(4x4mm)	Internal	FAN5608DHMPX
		External	FAN5608HMPX
	8-Lead MLP(3x3mm)	Internal	FAN5608DMPX
		External	FAN5608MPX

DISCLAIMER

FAIRCHILD SEMICONDUCTOR RESERVES THE RIGHT TO MAKE CHANGES WITHOUT FURTHER NOTICE TO ANY PRODUCTS HEREIN TO IMPROVE RELIABILITY, FUNCTION OR DESIGN. FAIRCHILD DOES NOT ASSUME ANY LIABILITY ARISING OUT OF THE APPLICATION OR USE OF ANY PRODUCT OR CIRCUIT DESCRIBED HEREIN; NEITHER DOES IT CONVEY ANY LICENSE UNDER ITS PATENT RIGHTS, NOR THE RIGHTS OF OTHERS.

PRELIMINARY INFORMATION DESCRIBES PRODUCTS THAT ARE NOT IN FULL PRODUCTION AT THE TIME OF PRINTING. SPECIFICATIONS ARE BASED ON SIMULATION AND LIMITED CHARACTERIZATION. THEY MAY CHANGE WITHOUT NOTICE. CONTACT FAIRCHILD SEMICONDUCTOR FOR CURRENT INFORMATION.



LIFE SUPPORT POLICY

FAIRCHILD'S PRODUCTS ARE NOT AUTHORIZED FOR USE AS CRITICAL COMPONENTS IN LIFE SUPPORT DEVICES OR SYSTEMS WITHOUT THE EXPRESS WRITTEN APPROVAL OF THE PRESIDENT OF FAIRCHILD SEMICONDUCTOR CORPORATION. As used herein:

1. Life support devices or systems are devices or systems which, (a) are intended for surgical implant into the body, or (b) support or sustain life, and (c) whose failure to perform when properly used in accordance with instructions for use provided in the labeling, can be reasonably expected to result in a significant injury of the user.
2. A critical component in any component of a life support device or system whose failure to perform can be reasonably expected to cause the failure of the life support device or system, or to affect its safety or effectiveness.

Looking for pricing, stock, or lifecycle information?

Click below to explore more details on WIN SOURCE:

-  [View FAN5608DHMPX on WIN SOURCE](#)
-  [Fairchild/ON Semiconductor Information](#)

Optimize Your Supply Chain with WIN SOURCE Solutions

-  Global Sourcing Solution
-  Obsolete Management
-  Cost Control Management
-  Shortage Management
-  Alternative Solution
-  Excess Inventory Management