



**THE DATASHEET OF
AK8131C**





Low Power Multiclock Generator with VCXO AK8131C

Features

- 27MHz Crystal Input
- Clock out Frequencies:
 - REFOUT: 27.000MHz
 - CLK1: 33.000MHz
 - CLK2: 33.000MHz
 - CLK3: 27.000MHz
 - CLK4: 27.000MHz
- Built-in VCXO
 - Pull Range: ± 100 ppm (Min.)
- Low Jitter Performance
 - Period Jitter : 120 psec (Typ.) at CLK1/CLK2
 - Long Term Jitter : 160 psec (Typ.) at REFOUT/CLK3/4
- Low Current Consumption: 10.0mA (Typ.) at 3.3V
- Supply Voltage: 3.0 – 3.6V
- Operating Temperature Range: -20 to +85°C
- Package: 16-pin SSOP (Lead free)

Description

The AK8131C is a member of AKEMD's low power multi clock generator family designed for a feature rich DTV or STB, requiring a range of system clocks with high performance. The on-chip VCXO accepts a voltage control input to allow the output clocks to vary by ± 100 ppm for synchronizing to the external clock system. Both circuitries of VCXO and PLL in AK8131C are derived from AKEMD's long-term-experienced clock device technology, and enable clock output to perform low jitter and to operate with very low current consumption. The AK8131C is available in a 16-pin SSOP package.

Applications

- Digital TV Sets
- Personal Video Recorders
- Set-Top-Boxes
- Multi Media Receivers

Block Diagram

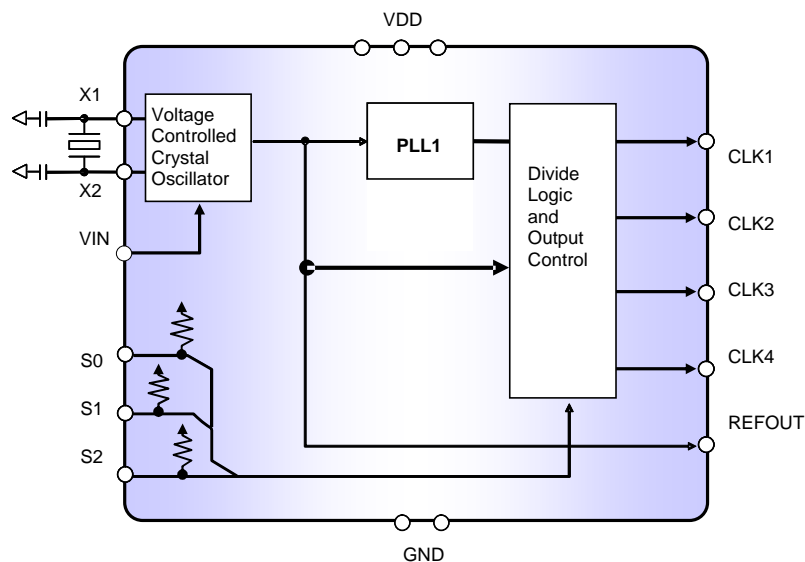

AK8131C Multi Clock Generator

Pin Descriptions

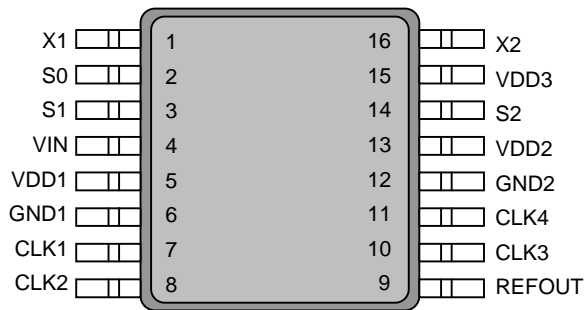

Package: 16-Pin SSOP(Top View)

Pin No.	Pin Name	Pin Type	Description
1	X1	XO	Crystal connection, Connect to 27.000MHz crystal
2	S0	IN	Clock Out Frequency Select 0, See Table 1 for the selection (1)
3	S1	IN	Clock Out Frequency select 1, See Table 1 for the selection (1)
4	VIN	IN	VCXO Control Voltage Input
5	VDD1	--	Power Supply 1
6	GND1	--	Ground 1
7	CLK1	OUT	Clock output 1, See Table 1 for its selectable frequency (2)
8	CLK2	OUT	Clock output 2, See Table 1 for its selectable frequency (2)
9	REF OUT	OUT	Reference Clock Output of VCXO based on 27.000MHz Crystal
10	CLK3	OUT	Clock output 3, See Table 1 for its selectable frequency (2)
11	CLK4	OUT	Clock output 4, See Table 1 for its selectable frequency (2)
12	GND2	--	Ground 2
13	VDD2	--	Power Supply 2
14	S2	IN	Clock Out Frequency select 1, See Table 1 for the selection (1)
15	VDD3	--	Power Supply 3
16	X2	XI	Crystal connection, Connect to 27.000MHz crystal

(1) Internal pull up 360kΩ

(2) Internal pull down 510kΩ

Ordering Information

Part Number	Marking	Shipping Packaging	Package	Temperature Range
AK8131C	8131C	Tape and Reel	16-pin SSOP	-20 to 85 °C

Absolute Maximum Rating

Over operating free-air temperature range unless otherwise noted ⁽¹⁾

Items	Symbol	Ratings	Unit
Supply voltage	VDD	-0.3 to 4.6	V
Input voltage	V _{in}	VSS-0.3 to VDD+0.3	V
Input current (any pins except supplies)	I _{IN}	±10	mA
Storage temperature	T _{stg}	-55 to 130	°C

Note

(1) Stress beyond those listed under “Absolute Maximum Ratings” may cause permanent damage to the device. These are stress ratings only. Functional operation of the device at these or any other conditions beyond those indicated under “Recommended Operating Conditions” is not implied. Exposure to absolute-maximum-rating conditions for extended periods may affect device reliability. Electrical parameters are guaranteed only over the recommended operating temperature range.



ESD Sensitive Device

This device is manufactured on a CMOS process, therefore, generically susceptible to damage by excessive static voltage. Failure to observe proper handling and installation procedures can cause damage. AKEMD recommends that this device is handled with appropriate precautions.

Recommended Operation Conditions

Parameter	Symbol	Conditions	Min	Typ	Max	Unit
Operating temperature	T _a		-20		85	°C
Supply voltage ⁽¹⁾	VDD		3.0	3.3	3.6	V
Output Load Capacitance	C _{p1}	Pin: CLK1-4			15	pF
	C _{p2}	Pin: REFOUT			25	pF

Note:

(1) Power to VDD1, VDD2 and VDD3 requires to be supplied from a single source. A decoupling capacitor of 0.1μF for power supply line should be installed close to each VDD pin.

DC Characteristics

All specifications at VDD: over 3.0 to 3.6V, Ta: -20 to +85°C, 27MHz Crystal, unless otherwise noted

Parameter	Symbol	Conditions	MIN	TYP	MAX	Unit
High Level Input Voltage	V_{IH}	Pin: S0,S1,S2	0.7VDD			V
Low Level Input Voltage	V_{IL}	Pin: S0,S1,S2			0.3VDD	V
Input Current 1	I_{L1}	Pin: S0,S1,S2	-20		+10	μ A
Input Current 2	I_{L2}	Pin: VIN	-3		+3	μ A
High Level Output Voltage	V_{OH}	Pin: CLK1-4, REFOUT $I_{OH}=-4$ mA	0.8VDD			V
Low level Output Voltage	V_{OL}	Pin: CLK1-4, REFOUT $I_{OL}=+4$ mA			0.2VDD	V
Current Consumption	I_{DD}	No load Clock out selection by note ⁽¹⁾ Ta=25°C		10.0		mA

(1) Pin setting for output clock selection: [S2:S0] = HHH

AC Characteristics

All specifications at VDD: over 3.0 to 3.6V, Ta: over -20 to +85°C, 27MHz Crystal, unless otherwise noted

Parameter	Symbol	Conditions	MIN	TYP	MAX	Unit
Crystal Clock Frequency				27.0000		MHz
VCXO Pullable Range ⁽³⁾		VIN at over 0 to VDD V	\pm 100			ppm
VCXO Gain	G_{VCXO}	VIN range at 1.5V \pm 1.0V		130		ppm/ V
Period Jitter ⁽⁴⁾		CLK1-2		120		ps
Long term Jitter ⁽⁵⁾ r 1000 cycle		REFOUT at 27.000MHz 1000 cycle delay		150		ps
Output Clock Duty Cycle		Pin: CLK1-2 ⁽¹⁾	45	50	55	%
		Pin: CLK3-4 ⁽¹⁾ ,REFOUT ⁽²⁾	40	50	60	%
Output Clock Rise Time	t_{rise}	Pin: CLK1-4 ⁽¹⁾		1.5		ns
		Pin: REFOUT ⁽²⁾		2.5		ns
Output Clock Fall Time	t_{fall}	Pin: CLK1-4 ⁽¹⁾		1.8		ns
		Pin: REFOUT ⁽²⁾		2.5		ns
Power-up Time		Pin: CLK1-2 ⁽¹⁾⁽²⁾⁽⁶⁾		5		ms

(1) Measured with load capacitance of 15pF

(2) Measured with load capacitance of 25pF

(3) Pullable range depends on crystal characteristics, on-chip load capacitance, and stray capacity of PCB.
Min. \pm 100ppm is applied to AKEMD's authorized test condition.

(4) $6\sigma(\pm 3\sigma)$ in 10000 sampling

(5) $6\sigma(\pm 3\sigma)$ in 10000 sampling

(6) CLK1 and CLK2 are generated from 27MHz by using a PLL.

Output clock frequency selection

The AK8131C generates a range of low-jitter and hi-accuracy clock frequency with a built-in PLL and provides to up to four assigned outputs. A frequency selection at assigned output pin is configured by pin-setting of S0 (Pin2), S1 (Pin3), and S2 (Pin14).

The selectable frequency is shown in **Table 1**..

Table 1: Clock output Frequency

Selection Pin			Clock Output Frequency (MHz)			
S2 (Pin 14)	S1 (Pin 3)	S0 (Pin 2)	CLK1 (Pin 7)	CLK2 (Pin 8)	CLK3 (Pin 10)	CLK4 (Pin 11)
L	L	L	OFF	OFF	OFF	OFF
L	L	H	OFF	OFF	OFF	27.000
L	H	L	OFF	33.000	OFF	OFF
L	H	H	OFF	33.000	OFF	27.000
H	L	L	OFF	OFF	27.000	27.000
H	L	H	33.000	33.000	OFF	OFF
H	H	L	33.000	33.000	OFF	27.000
H	H	H	33.000	33.000	27.000	27.000

* When S2, S1 and S0 are open, the frequency selection is same as "H/H/H".

* CLK3 and CLK4 are copy of REFOUT.

Package Information

• **Mechanical data**

16pin SSOP (Unit: mm)

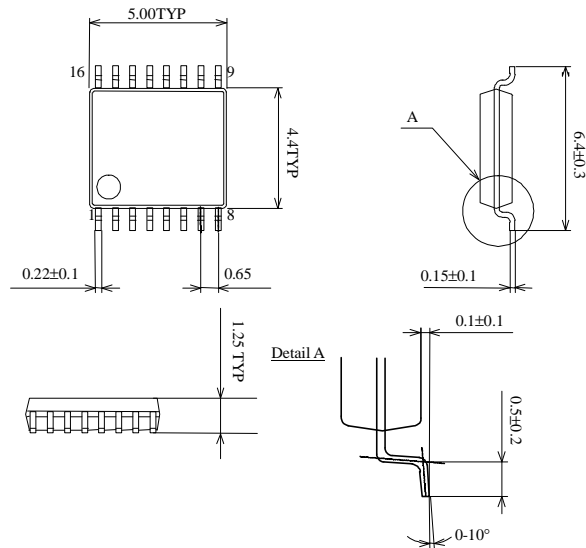

• **Marking**

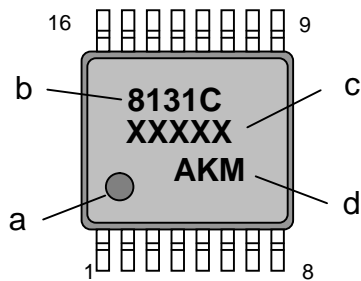

- a: #1 Pin Index
- b: Part number
- c: Date code (5 digits)
- d: Product Family Logo ⁽¹⁾

(1) **AKM** is the brand name of AKEMD's IC's.

AKM and the logo -  - are the brand of AKEMD's IC's and identify that AKEMD continues to offer the best choice for high performance mixed-signal solution under this brand.

• **RoHS Compliance**

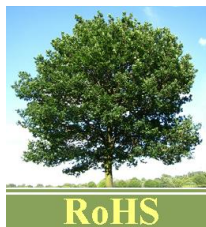

All integrated circuits from Asahi Kasei EMD Corporation (AKEMD) assembled in "lead-free" packages* are fully compliant with RoHS.

(*) RoHS compliant products from AKEMD are identified with "Pb free" letter indication on product label posted on the anti-shield bag and boxes.



This page is intentionally blank.

IMPORTANT NOTICE







- I These products and their specifications are subject to change without notice.
When you consider any use or application of these products, please make inquiries the sales office of Asahi Kasei EMD Corporation (AKEMD) or authorized distributors as to current status of the products.
- I AKEMD assumes no liability for infringement of any patent, intellectual property, or other rights in the application or use of any information contained herein.
- I Any export of these products, or devices or systems containing them, may require an export license or other official approval under the law and regulations of the country of export pertaining to customs and tariffs, currency exchange, or strategic materials.
- I AKEMD products are neither intended nor authorized for use as critical components^{Note1)} in any safety, life support, or other hazard related device or system^{Note2)}, and AKEMD assumes no responsibility for such use, except for the use approved with the express written consent by Representative Director of AKEMD. As used here:
 - Note1) A critical component is one whose failure to function or perform may reasonably be expected to result, whether directly or indirectly, in the loss of the safety or effectiveness of the device or system containing it, and which must therefore meet very high standards of performance and reliability.
 - Note2) A hazard related device or system is one designed or intended for life support or maintenance of safety or for applications in medicine, aerospace, nuclear energy, or other fields, in which its failure to function or perform may reasonably be expected to result in loss of life or in significant injury or damage to person or property.
- I It is the responsibility of the buyer or distributor of AKEMD products, who distributes, disposes of, or otherwise places the product with a third party, to notify such third party in advance of the above content and conditions, and the buyer or distributor agrees to assume any and all responsibility and liability for and hold AKEMD harmless from any and all claims arising from the use of said product in the absence of such notification.

Looking for pricing, stock, or lifecycle information?

Click below to explore more details on WIN SOURCE:

-  [View AK8131C on WIN SOURCE](#)
-  [Asahi Kasei Microsystems Information](#)

Optimize Your Supply Chain with WIN SOURCE Solutions

-  Global Sourcing Solution
-  Obsolete Management
-  Cost Control Management
-  Shortage Management
-  Alternative Solution
-  Excess Inventory Management