



**THE DATASHEET OF
UC2572N**



Negative Output Flyback Pulse Width Modulator

FEATURES

- Simple Single Inductor Flyback PWM for Negative Voltage Generation
- Drives External PMOS Switch
- Contains UVLO Circuit
- Includes Pulse-by-Pulse Current Limit
- Low 50 μ A Sleep Mode Current

DESCRIPTION

The UC3572 is a negative output flyback pulse width modulator which converts a positive input voltage to a regulated negative output voltage. The chip is optimized for use in a single inductor negative flyback switching converter employing an external PMOS switch. The block diagram consists of a precision reference, an error amplifier configured for voltage mode operation, an oscillator, a PWM comparator with latching logic, and a 0.5A peak gate driver. The UC3572 includes an undervoltage lockout circuit to insure sufficient input supply voltage is present before any switching activity can occur, and a pulse-by-pulse current limit. Output current can be sensed and limited to a user determined maximum value. The UVLO circuit turns the chip off when the input voltage is below the UVLO threshold. In addition, a sleep comparator interfaces to the UVLO circuit to turn the chip off. This reduces the supply current to only 50 μ A, making the UC3572 ideal for battery powered applications.

BLOCK DIAGRAM

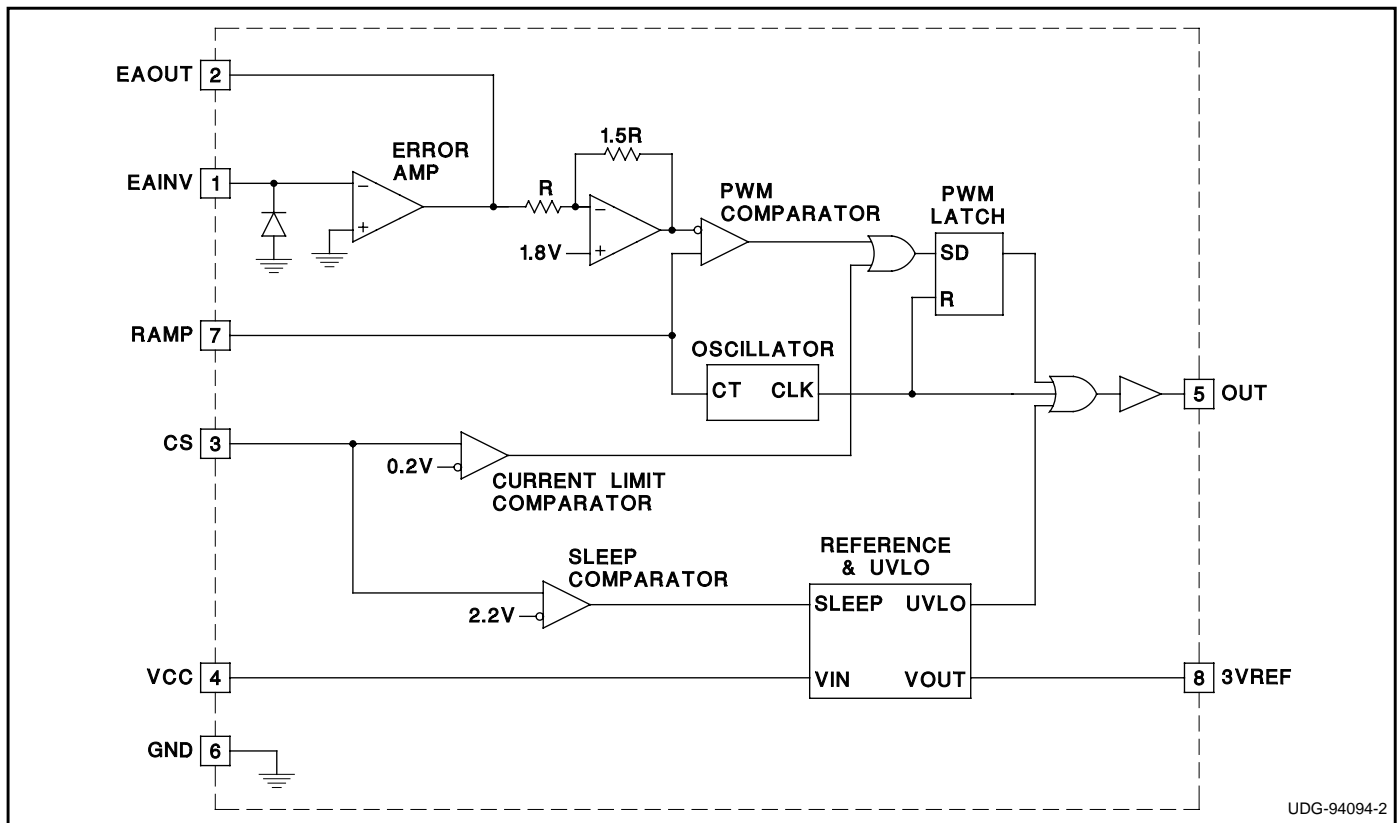

UDG-94094-2

ABSOLUTE MAXIMUM RATINGS

VCC	35V
EAINV	-0.6V to VCC
IEAOUT	25mA
RAMP	-0.3V to 4V
CS	-0.3V to VCC
Iout	-0.7A to 0.7A
I3VREF	-15mA
Storage Temperature	-65°C to +150°C
Junction Temperature	-65°C to +150°C
Lead Temperature (Soldering, 10 sec.)	+300°C

Currents are positive into, negative out of the specified terminal. Consult Packaging Section of Databook for thermal limitations and considerations of packages.

CONNECTION DIAGRAM

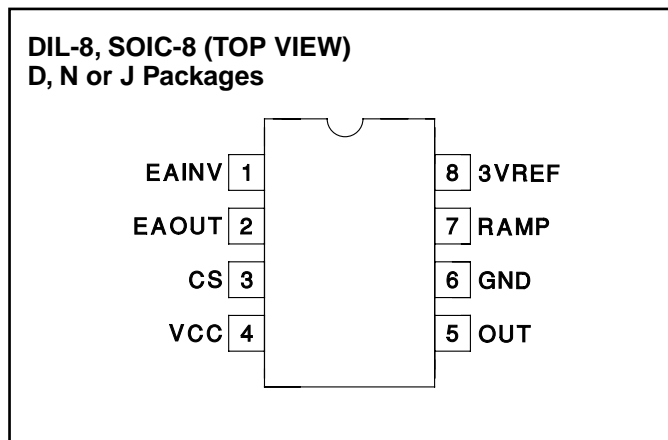

ORDERING INFORMATION

	TEMPERATURE RANGE	PACKAGE
UC1572	-55°C to +125°C	J
UC2572	-40°C to +85°C	D, N or J
UC3572	0°C to +70°C	D or N

ELECTRICAL CHARACTERISTICS: Unless otherwise specified, VCC = 5V, CT = 680pF, TA = TJ.

PARAMETER	TEST CONDITIONS	MIN	TYP	MAX	UNITS
Reference Section					
3VREF		2.94	3	3.06	V
Line Regulation	VCC = 4.75 to 30V		1	10	mV
Load Regulation	I3VREF = 0V to -5mA		1	10	mV
Oscillator Section					
Frequency	VCC = 5V to 30V	85	100	115	kHz
Error Amp Section					
EAINV	EAOUT = 2V IEANV = -1mA	-10	0	10	mV
IEAINV	EAOUT = 2V		-0.2	-1.0	μA
AVOL	EAOUT = 0.5V to 3V	65	90		dB
EAOUT High	EAINV = -100mV	3.6	4	4.4	V
EAOUT Low	EAINV = 100mV		0.1	0.2	V
IEAOUT	EAINV = -100mV, EAOUT = 2V EAINV = 100mV, EAOUT = 2V	-350	-500		μA
Unity Gain Bandwidth	TJ = 25°C, F = 10kHz	0.6	1		MHz
Current Sense Comparator Section					
Threshold		0.185	0.205	0.225	V
Input Bias Current	CS = 0		-0.4	-1	μA
CS Propagation Delay			300		nS

ELECTRICAL CHARACTERISTICS: Unless otherwise specified, VCC = 5V, CT = 680pF, TA = TJ.

PARAMETER	TEST CONDITIONS	MIN	TYP	MAX	UNITS
Gate Drive Output Section					
OUT High Saturation	IOUT = 0		0	0.3	V
	IOUT = -10mA		0.7	1.5	V
	IOUT = -100mA		1.5	2.5	V
OUT Low Saturation	IOUT = 10mA		0.1	0.4	V
	IOUT = 100mA		1.5	2.2	V
Rise Time	TJ = 25°C, CLOAD = 1nF + 3.3 Ohms		30	80	nS
Fall Time	TJ = 25°C, CLOAD = 1nF + 3.3 Ohms		30	80	nS
Pulse Width Modulator Section					
Maximum Duty Cycle	EAINV = +100mV, VCC = 5V to 30V		92	96	%
Minimum Duty Cycle	EAINV = -100mV, VCC = 5V to 30V			0	%
Modulator Gain	EAOUT = 1.5V to 2.5V	45	55	65	%/V
Undervoltage Lockout Section					
Start Threshold		3.5	4.2	4.5	V
Hysteresis		100	200	300	mV
Sleep Mode Section					
Threshold		1.8	2.2	2.6	V
Supply Current Section					
IVCC	VCC = 5V, 30V		9	15	mA
	VCC = 30, CS = 3V		50	150	μA

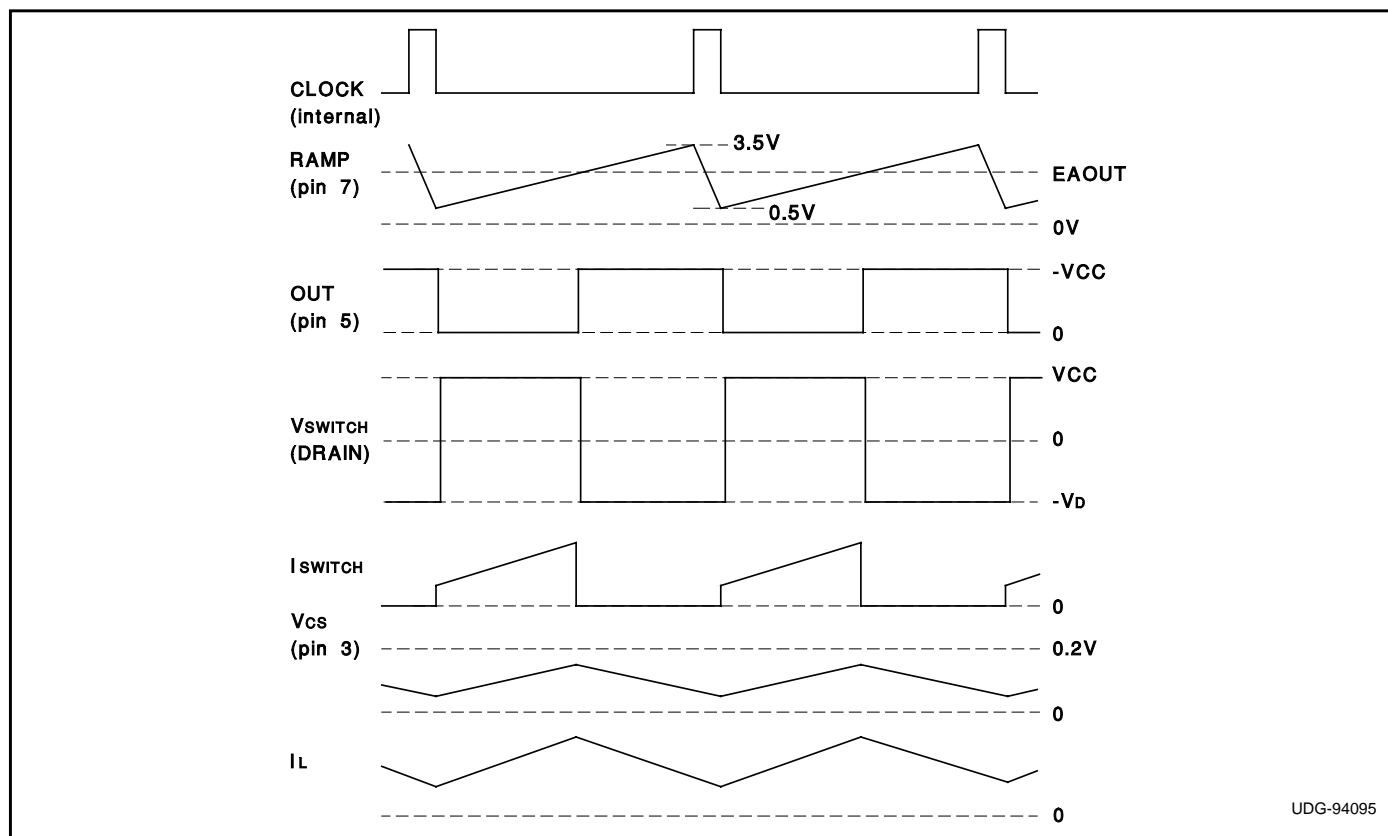

Figure 1. Typical waveforms.

PIN DESCRIPTIONS

3VREF: Precision 3V reference. Bypass with 100nF capacitor to GND.

CS: Current limit sense pin. Connect to a ground referenced current sense resistor in series with the flyback inductor. OUT will be held high (PMOS switch off) if CS exceeds 0.2V.

EAINV: Inverting input to error amplifier. Summing junction for 3VREF and VOUT sense. The non-inverting input of the error amplifier is internally connected to GND. This pin will source a maximum of 1mA.

EAOUT: Output of error amplifier. Use EAOUT and EAINV for loop compensation components.

GND: Circuit Ground.

OUT: Gate drive for external PMOS switch connected between VCC and the flyback inductor. OUT drives the gate of the PMOS switch between VCC and GND.

RAMP: Oscillator and ramp for pulse width modulator. Frequency is set by a capacitor to GND by the equation

$$F = \frac{1}{15k \cdot C_{RAMP}}$$

Recommended operating frequency range is 10kHz to 200kHz.

VCC: Input voltage supply to chip. Range is 4.75 to 30V. Bypass with a 1μF capacitor.

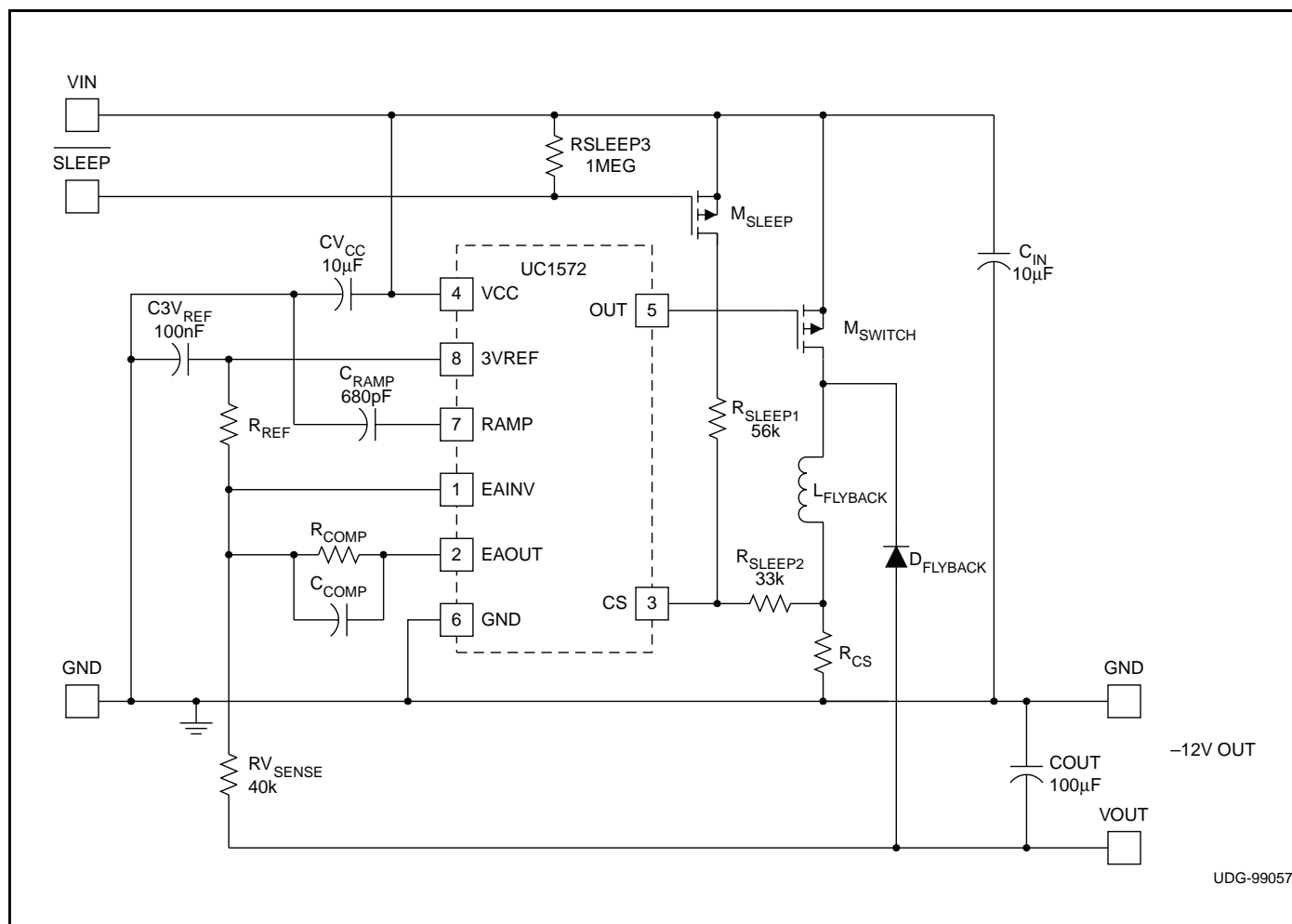

Figure 2. Typical application: +5V to -12V flyback converter.

PACKAGING INFORMATION

Orderable Device	Status ⁽¹⁾	Package Type	Package Drawing	Pins	Package Qty	Eco Plan ⁽²⁾	Lead/Ball Finish	MSL Peak Temp ⁽³⁾
UC1572J	OBSOLETE	CDIP	J	8		TBD	Call TI	Call TI
UC2572D	ACTIVE	SOIC	D	8	75	Green (RoHS & no Sb/Br)	CU NIPDAU	Level-1-260C-UNLIM
UC2572DG4	ACTIVE	SOIC	D	8	75	Green (RoHS & no Sb/Br)	CU NIPDAU	Level-1-260C-UNLIM
UC2572DTR	ACTIVE	SOIC	D	8	2500	Green (RoHS & no Sb/Br)	CU NIPDAU	Level-1-260C-UNLIM
UC2572DTRG4	ACTIVE	SOIC	D	8	2500	Green (RoHS & no Sb/Br)	CU NIPDAU	Level-1-260C-UNLIM
UC2572N	ACTIVE	PDIP	P	8	50	Green (RoHS & no Sb/Br)	CU NIPDAU	N / A for Pkg Type
UC2572NG4	ACTIVE	PDIP	P	8	50	Green (RoHS & no Sb/Br)	CU NIPDAU	N / A for Pkg Type
UC3572D	ACTIVE	SOIC	D	8	75	Green (RoHS & no Sb/Br)	CU NIPDAU	Level-1-260C-UNLIM
UC3572DG4	ACTIVE	SOIC	D	8	75	Green (RoHS & no Sb/Br)	CU NIPDAU	Level-1-260C-UNLIM
UC3572DTR	ACTIVE	SOIC	D	8	2500	Green (RoHS & no Sb/Br)	CU NIPDAU	Level-1-260C-UNLIM
UC3572DTRG4	ACTIVE	SOIC	D	8	2500	Green (RoHS & no Sb/Br)	CU NIPDAU	Level-1-260C-UNLIM
UC3572N	ACTIVE	PDIP	P	8	50	Green (RoHS & no Sb/Br)	CU NIPDAU	N / A for Pkg Type
UC3572NG4	ACTIVE	PDIP	P	8	50	Green (RoHS & no Sb/Br)	CU NIPDAU	N / A for Pkg Type

⁽¹⁾ The marketing status values are defined as follows:

ACTIVE: Product device recommended for new designs.

LIFEBUY: TI has announced that the device will be discontinued, and a lifetime-buy period is in effect.

NRND: Not recommended for new designs. Device is in production to support existing customers, but TI does not recommend using this part in a new design.

PREVIEW: Device has been announced but is not in production. Samples may or may not be available.

OBSOLETE: TI has discontinued the production of the device.

⁽²⁾ Eco Plan - The planned eco-friendly classification: Pb-Free (RoHS), Pb-Free (RoHS Exempt), or Green (RoHS & no Sb/Br) - please check <http://www.ti.com/productcontent> for the latest availability information and additional product content details.

TBD: The Pb-Free/Green conversion plan has not been defined.

Pb-Free (RoHS): TI's terms "Lead-Free" or "Pb-Free" mean semiconductor products that are compatible with the current RoHS requirements for all 6 substances, including the requirement that lead not exceed 0.1% by weight in homogeneous materials. Where designed to be soldered at high temperatures, TI Pb-Free products are suitable for use in specified lead-free processes.

Pb-Free (RoHS Exempt): This component has a RoHS exemption for either 1) lead-based flip-chip solder bumps used between the die and package, or 2) lead-based die adhesive used between the die and leadframe. The component is otherwise considered Pb-Free (RoHS compatible) as defined above.

Green (RoHS & no Sb/Br): TI defines "Green" to mean Pb-Free (RoHS compatible), and free of Bromine (Br) and Antimony (Sb) based flame retardants (Br or Sb do not exceed 0.1% by weight in homogeneous material)

⁽³⁾ MSL, Peak Temp. -- The Moisture Sensitivity Level rating according to the JEDEC industry standard classifications, and peak solder temperature.

Important Information and Disclaimer: The information provided on this page represents TI's knowledge and belief as of the date that it is provided. TI bases its knowledge and belief on information provided by third parties, and makes no representation or warranty as to the accuracy of such information. Efforts are underway to better integrate information from third parties. TI has taken and continues to take reasonable steps to provide representative and accurate information but may not have conducted destructive testing or chemical analysis on incoming materials and chemicals. TI and TI suppliers consider certain information to be proprietary, and thus CAS numbers and other limited

information may not be available for release.

In no event shall TI's liability arising out of such information exceed the total purchase price of the TI part(s) at issue in this document sold by TI to Customer on an annual basis.

TAPE AND REEL INFORMATION



QUADRANT ASSIGNMENTS FOR PIN 1 ORIENTATION IN TAPE



*All dimensions are nominal

Device	Package Type	Package Drawing	Pins	SPQ	Reel Diameter (mm)	Reel Width W1 (mm)	A0 (mm)	B0 (mm)	K0 (mm)	P1 (mm)	W (mm)	Pin1 Quadrant
UC2572DTR	SOIC	D	8	2500	330.0	12.4	6.4	5.2	2.1	8.0	12.0	Q1
UC3572DTR	SOIC	D	8	2500	330.0	12.4	6.4	5.2	2.1	8.0	12.0	Q1

TAPE AND REEL BOX DIMENSIONS



*All dimensions are nominal

Device	Package Type	Package Drawing	Pins	SPQ	Length (mm)	Width (mm)	Height (mm)
UC2572DTR	SOIC	D	8	2500	340.5	338.1	20.6
UC3572DTR	SOIC	D	8	2500	340.5	338.1	20.6

IMPORTANT NOTICE

Texas Instruments Incorporated and its subsidiaries (TI) reserve the right to make corrections, modifications, enhancements, improvements, and other changes to its products and services at any time and to discontinue any product or service without notice. Customers should obtain the latest relevant information before placing orders and should verify that such information is current and complete. All products are sold subject to TI's terms and conditions of sale supplied at the time of order acknowledgment.

TI warrants performance of its hardware products to the specifications applicable at the time of sale in accordance with TI's standard warranty. Testing and other quality control techniques are used to the extent TI deems necessary to support this warranty. Except where mandated by government requirements, testing of all parameters of each product is not necessarily performed.

TI assumes no liability for applications assistance or customer product design. Customers are responsible for their products and applications using TI components. To minimize the risks associated with customer products and applications, customers should provide adequate design and operating safeguards.

TI does not warrant or represent that any license, either express or implied, is granted under any TI patent right, copyright, mask work right, or other TI intellectual property right relating to any combination, machine, or process in which TI products or services are used. Information published by TI regarding third-party products or services does not constitute a license from TI to use such products or services or a warranty or endorsement thereof. Use of such information may require a license from a third party under the patents or other intellectual property of the third party, or a license from TI under the patents or other intellectual property of TI.

Reproduction of TI information in TI data books or data sheets is permissible only if reproduction is without alteration and is accompanied by all associated warranties, conditions, limitations, and notices. Reproduction of this information with alteration is an unfair and deceptive business practice. TI is not responsible or liable for such altered documentation. Information of third parties may be subject to additional restrictions.

Resale of TI products or services with statements different from or beyond the parameters stated by TI for that product or service voids all express and any implied warranties for the associated TI product or service and is an unfair and deceptive business practice. TI is not responsible or liable for any such statements.

TI products are not authorized for use in safety-critical applications (such as life support) where a failure of the TI product would reasonably be expected to cause severe personal injury or death, unless officers of the parties have executed an agreement specifically governing such use. Buyers represent that they have all necessary expertise in the safety and regulatory ramifications of their applications, and acknowledge and agree that they are solely responsible for all legal, regulatory and safety-related requirements concerning their products and any use of TI products in such safety-critical applications, notwithstanding any applications-related information or support that may be provided by TI. Further, Buyers must fully indemnify TI and its representatives against any damages arising out of the use of TI products in such safety-critical applications.

TI products are neither designed nor intended for use in military/aerospace applications or environments unless the TI products are specifically designated by TI as military-grade or "enhanced plastic." Only products designated by TI as military-grade meet military specifications. Buyers acknowledge and agree that any such use of TI products which TI has not designated as military-grade is solely at the Buyer's risk, and that they are solely responsible for compliance with all legal and regulatory requirements in connection with such use.

TI products are neither designed nor intended for use in automotive applications or environments unless the specific TI products are designated by TI as compliant with ISO/TS 16949 requirements. Buyers acknowledge and agree that, if they use any non-designated products in automotive applications, TI will not be responsible for any failure to meet such requirements.

Following are URLs where you can obtain information on other Texas Instruments products and application solutions:

Products

Amplifiers	amplifier.ti.com
Data Converters	dataconverter.ti.com
DSP	dsp.ti.com
Clocks and Timers	www.ti.com/clocks
Interface	interface.ti.com
Logic	logic.ti.com
Power Mgmt	power.ti.com
Microcontrollers	microcontroller.ti.com
RFID	www.ti-rfid.com
RF/IF and ZigBee® Solutions	www.ti.com/lprf



Applications

Audio	www.ti.com/audio
Automotive	www.ti.com/automotive
Broadband	www.ti.com/broadband
Digital Control	www.ti.com/digitalcontrol
Medical	www.ti.com/medical
Military	www.ti.com/military
Optical Networking	www.ti.com/opticalnetwork
Security	www.ti.com/security
Telephony	www.ti.com/telephony
Video & Imaging	www.ti.com/video
Wireless	www.ti.com/wireless

Mailing Address: Texas Instruments, Post Office Box 655303, Dallas, Texas 75265
Copyright © 2008, Texas Instruments Incorporated

Looking for pricing, stock, or lifecycle information?

Click below to explore more details on WIN SOURCE:

-  [View UC2572N on WIN SOURCE](#)
-  [Texas Instruments](#) Information

Optimize Your Supply Chain with WIN SOURCE Solutions

-  Global Sourcing Solution
-  Obsolete Management
-  Cost Control Management
-  Shortage Management
-  Alternative Solution
-  Excess Inventory Management