



THE DATASHEET OF OP496GS



OP196/OP296/OP496

FEATURES

Rail-to-Rail Input and Output Swing
Low Power: 60 μ A/Amplifier
Gain Bandwidth Product: 450 kHz
Single-Supply Operation: 3 V to 12 V
Low Offset Voltage: 300 μ V max
High Open-Loop Gain: 500 V/mV
Unity-Gain Stable
No Phase Reversal

APPLICATIONS

Battery Monitoring
Sensor Conditioners
Portable Power Supply Control
Portable Instrumentation

GENERAL DESCRIPTION

The OP196 family of CBCMOS operational amplifiers features micropower operation and rail-to-rail input and output ranges.

The extremely low power requirements and guaranteed operation from 3 V to 12 V make these amplifiers perfectly suited to monitor battery usage and to control battery charging. Their dynamic performance, including 26 nV/ $\sqrt{\text{Hz}}$ voltage noise density, recommends them for battery-powered audio applications. Capacitive loads to 200 pF are handled without oscillation.

The OP196/OP296/OP496 are specified over the industrial (-40°C to $+125^{\circ}\text{C}$) temperature range. 3 V operation is specified over the 0°C to 125°C temperature range.

The single OP196 and the dual OP296 are available in 8-lead

PIN CONFIGURATIONS

8-Lead Narrow-Body SO

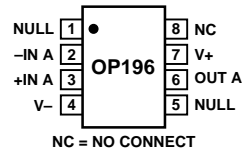

8-Lead Narrow-Body SO

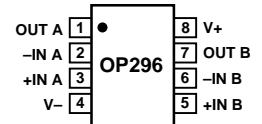

8-Lead TSSOP

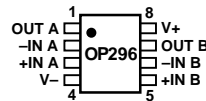

14-Lead Narrow-Body SO

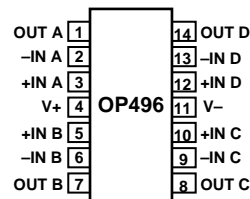

14-Lead TSSOP
(RU Suffix)

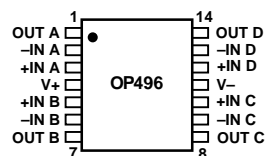

REV.

Information furnished by Analog Devices is believed to be accurate and reliable. However, no responsibility is assumed by Analog Devices for its use, nor for any infringements of patents or other rights of third parties that may result from its use. No license is granted by implication or otherwise under any patent or patent rights of Analog Devices.

OP196/OP296/OP496—SPECIFICATIONS

ELECTRICAL SPECIFICATIONS (@ $V_S = 5.0\text{ V}$, $V_{CM} = 2.5\text{ V}$, $T_A = 25^\circ\text{C}$, unless otherwise noted.)

Parameter	Symbol	Conditions	Min	Typ	Max	Unit
INPUT CHARACTERISTICS						
Offset Voltage	V_{OS}	OP196G, OP296G, OP496G $-40^\circ\text{C} \leq T_A \leq +125^\circ\text{C}$		35	300	μV
					650	μV
		OP296H, OP496H $-40^\circ\text{C} \leq T_A \leq +125^\circ\text{C}$			800	μV
Input Bias Current	I_B	$-40^\circ\text{C} \leq T_A \leq +125^\circ\text{C}$		± 10	± 50	nA
Input Offset Current	I_{OS}	$-40^\circ\text{C} \leq T_A \leq +125^\circ\text{C}$		± 1.5	± 8	nA
Input Voltage Range	V_{CM}	$-40^\circ\text{C} \leq T_A \leq +125^\circ\text{C}$	0		5.0	V
Common-Mode Rejection Ratio	CMRR	$0\text{ V} \leq V_{CM} \leq 5.0\text{ V}$, $-40^\circ\text{C} \leq T_A \leq +125^\circ\text{C}$	65			dB
Large Signal Voltage Gain	A_{VO}	$R_L = 100\text{ k}\Omega$, $0.30\text{ V} \leq V_{OUT} \leq 4.7\text{ V}$, $-40^\circ\text{C} \leq T_A \leq +125^\circ\text{C}$	150	200		V/mV
Long-Term Offset Voltage	V_{OS}	G Grade, Note 1			550	μV
		H Grade, Note 1			1	mV
Offset Voltage Drift	$\Delta V_{OS}/\Delta T$	G Grade, Note 2		1.5		$\mu\text{V}/^\circ\text{C}$
		H Grade, Note 2		2		$\mu\text{V}/^\circ\text{C}$
OUTPUT CHARACTERISTICS						
Output Voltage Swing High	V_{OH}	$I_L = +100\text{ }\mu\text{A}$	4.85	4.92		V
		$I_L = 1\text{ mA}$	4.30	4.56		V
		$I_L = 2\text{ mA}$		4.1		V
Output Voltage Swing Low	V_{OL}	$I_L = -$		36	70	mV
		$I_L = -1\text{ mA}$		350	550	mV
		$I_L = -2\text{ mA}$		750		mV
Output Current	I_{OUT}			± 4		mA
POWER SUPPLY						
Power Supply Rejection Ratio	PSRR	$\pm 2.5\text{ V} \leq V_S \leq \pm 6\text{ V}$, $-40^\circ\text{C} \leq T_A \leq +125^\circ\text{C}$	85			dB
Supply Current per Amplifier	I_{SY}	$V_{OUT} = 2.5\text{ V}$, $R_L = \infty$ $-40^\circ\text{C} \leq T_A \leq +125^\circ\text{C}$		45	60	μA
					80	μA
DYNAMIC PERFORMANCE						
Slew Rate	SR	$R_L = 100\text{ k}\Omega$		0.3		V/ μs
Gain Bandwidth Product	GBP			350		kHz
Phase Margin	θ_m			47		Degrees
NOISE PERFORMANCE						
Voltage Noise	e_n p-p	0.1 Hz to 10 Hz		0.8		$\mu\text{V p-p}$
Voltage Noise Density	e_n	$f = 1\text{ kHz}$		26		$\text{nV}/\sqrt{\text{Hz}}$
Current Noise Density	i_n	$f = 1\text{ kHz}$		0.19		$\text{pA}/\sqrt{\text{Hz}}$

NOTES

¹Long-term offset voltage is guaranteed by a 1,000 hour life test performed on three independent lots at 125°C , with an LTPD of 1.3.

²Offset voltage drift is the average of the -40°C to $+25^\circ\text{C}$ delta and the $+25^\circ\text{C}$ to $+125^\circ\text{C}$ delta.

Specifications subject to change without notice.

ELECTRICAL SPECIFICATIONS (@ $V_S = 3.0\text{ V}$, $V_{CM} = 1.5\text{ V}$, $T_A = 25^\circ\text{C}$, unless otherwise noted.)

Parameter	Symbol	Conditions	Min	Typ	Max	Unit
INPUT CHARACTERISTICS						
Offset Voltage	V_{OS}	OP196G, OP296G, OP496G $0^\circ\text{C} \leq T_A \leq 125^\circ\text{C}$ OP296H, OP496H $0^\circ\text{C} \leq T_A \leq 125^\circ\text{C}$		35	300 650 800 1.2	μV μV μV mV
Input Bias Current	I_B			± 10	± 50	nA
Input Offset Current	I_{OS}			± 1	± 8	nA
Input Voltage Range	V_{CM}		0		3.0	V
Common-Mode Rejection Ratio	CMRR	$0\text{ V} \leq V_{CM} \leq 3.0\text{ V}$, $0^\circ\text{C} \leq T_A \leq 125^\circ\text{C}$	60			dB
Large Signal Voltage Gain	A_{VO}	$R_L = 100\text{ k}\Omega$	80	200		V/mV
Long-Term Offset Voltage	V_{OS}	G Grade, Note 1 H Grade, Note 1			550 1	μV mV
Offset Voltage Drift	$\Delta V_{OS}/\Delta T$	G Grade, Note 2 H Grade, Note 2		1.5 2		$\mu\text{V}/^\circ\text{C}$ $\mu\text{V}/^\circ\text{C}$
OUTPUT CHARACTERISTICS						
Output Voltage Swing High	V_{OH}	$I_L = 100\text{ }\mu\text{A}$	2.85			V
Output Voltage Swing Low	V_{OL}	$I_L = -100\text{ }\mu\text{A}$			70	mV
POWER SUPPLY						
Supply Current per Amplifier	I_{SY}	$V_{OUT} = 1.5\text{ V}$, $R_L = \infty$ $0^\circ\text{C} \leq T_A \leq 125^\circ\text{C}$		40	60 80	μA μA
DYNAMIC PERFORMANCE						
Slew Rate	SR	$R_L = 100\text{ k}\Omega$		0.25		V/ μs
Gain Bandwidth Product	GBP			350		kHz
Phase Margin	ϕ_m			45		Degrees
NOISE PERFORMANCE						
Voltage Noise	e_n p-p	0.1 Hz to 10 Hz		0.8		$\mu\text{V p-p}$
Voltage Noise Density	e_n	$f = 1\text{ kHz}$		26		$\text{nV}/\sqrt{\text{Hz}}$
Current Noise Density	i_n	$f = 1\text{ kHz}$		0.19		$\text{pA}/\sqrt{\text{Hz}}$

NOTES

¹Long-term offset voltage is guaranteed by a 1,000 hour life test performed on three independent lots at 125°C, with an LTPD of 1.3.

²Offset voltage drift is the average of the 0°C to 25°C delta and the 25°C to 125°C delta.

Specifications subject to change without notice.

OP196/OP296/OP496

ELECTRICAL SPECIFICATIONS (@ $V_S = 12.0\text{ V}$, $V_{CM} = 6\text{ V}$, $T_A = 25^\circ\text{C}$, unless otherwise noted.)

Parameter	Symbol	Conditions	Min	Typ	Max	Unit
INPUT CHARACTERISTICS						
Offset Voltage	V_{OS}	OP196G, OP296G, OP496G $0^\circ\text{C} \leq T_A \leq 125^\circ\text{C}$		35	300	μV
		OP296H, OP496H $0^\circ\text{C} \leq T_A \leq 125^\circ\text{C}$			650	μV
Input Bias Current	I_B	$-40^\circ\text{C} \leq T_A \leq +125^\circ\text{C}$		± 10	± 50	nA
Input Offset Current	I_{OS}	$-40^\circ\text{C} \leq T_A \leq +125^\circ\text{C}$		± 1	± 8	nA
Input Voltage Range	V_{CM}		0		12	V
Common-Mode Rejection Ratio	CMRR	$0\text{ V} \leq V_{CM} \leq 12\text{ V}$, $-40^\circ\text{C} \leq T_A \leq +125^\circ\text{C}$	65			dB
Large Signal Voltage Gain	A_{VO}	$R_L = 100\text{ k}\Omega$	300	1000		V/mV
Long-Term Offset Voltage	V_{OS}	G Grade, Note 1			550	μV
		H Grade, Note 1			1	mV
Offset Voltage Drift	$\Delta V_{OS}/\Delta T$	G Grade, Note 2		1.5		$\mu\text{V}/^\circ\text{C}$
		H Grade, Note 2		2		$\mu\text{V}/^\circ\text{C}$
OUTPUT CHARACTERISTICS						
Output Voltage Swing High	V_{OH}	$I_L = 100\text{ }\mu\text{A}$	11.85			V
		$I_L = 1\text{ mA}$	11.30			V
Output Voltage Swing Low	V_{OL}	$I_L = -$			70	mV
		$I_L = -1\text{ mA}$			550	mV
Output Current	I_{OUT}			± 4		mA
POWER SUPPLY						
Supply Current per Amplifier	I_{SY}	$V_{OUT} = 6\text{ V}$, $R_L = \infty$ $-40^\circ\text{C} \leq T_A \leq +125^\circ\text{C}$			60	μA
					80	μA
Supply Voltage Range	V_S		3		12	V
DYNAMIC PERFORMANCE						
Slew Rate	SR	$R_L = 100\text{ k}\Omega$		0.3		V/ μs
Gain Bandwidth Product	GBP			450		kHz
Phase Margin	ϕ_m			50		Degrees
NOISE PERFORMANCE						
Voltage Noise	e_n p-p	0.1 Hz to 10 Hz		0.8		$\mu\text{V p-p}$
Voltage Noise Density	e_n	$f = 1\text{ kHz}$		26		$\text{nV}/\sqrt{\text{Hz}}$
Current Noise Density	i_n	$f = 1\text{ kHz}$		0.19		$\text{pA}/\sqrt{\text{Hz}}$

NOTES

¹Long-term offset voltage is guaranteed by a 1,000 hour life test performed on three independent lots at 125°C , with an LTPD of 1.3.

²Offset voltage drift is the average of the -40°C to $+25^\circ\text{C}$ delta and the $+25^\circ\text{C}$ to $+125^\circ\text{C}$ delta.

Specifications subject to change without notice.

ABSOLUTE MAXIMUM RATINGS¹

Supply Voltage 15 V
 Input Voltage² 15 V
 Differential Input Voltage² 15 V
 Output Short Circuit Duration Indefinite
 Storage Temperature Range
 S, RU Package -65°C to +150°C
 Operating Temperature Range
 OP196G, OP296G, OP496G, H -40°C to +125°C
 Junction Temperature Range
 S, RU Package -65°C to +150°C
 Lead Temperature Range (Soldering, 60 sec) 300°C

Package Type	θ_{JA} ³	θ_{JC}	Unit
8-Lead SOIC	158	43	°C/W
8-Lead TSSOP	240	43	°C/W
14-Lead SOIC	120	36	°C/W
14-Lead TSSOP	180	35	°C/W

NOTES

¹Absolute maximum ratings apply to

²For supply voltages less than 15 V, the absolute maximum input voltage is equal to the supply voltage.

³ θ_{JA} is specified for the worst case conditions

CAUTION

ESD (electrostatic discharge) sensitive device. Electrostatic charges as high as 4000 V readily accumulate on the human body and test equipment and can discharge without detection. Although the OP196/OP296/OP496 feature proprietary ESD protection circuitry, permanent damage may occur on devices subjected to high-energy electrostatic discharges. Therefore, proper ESD precautions are recommended to avoid performance degradation or loss of functionality.



OP196/OP296/OP496—Typical Performance Characteristics

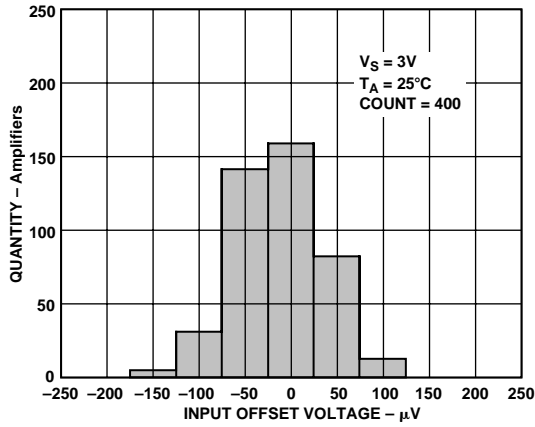

TPC 1. Input Offset Voltage Distribution

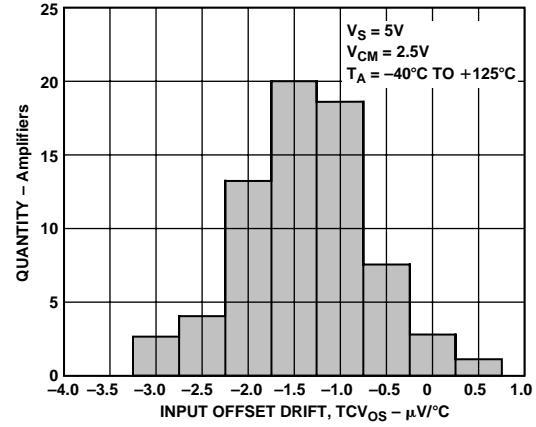

TPC 4. Input Offset Voltage Distribution (TCV_{OS})

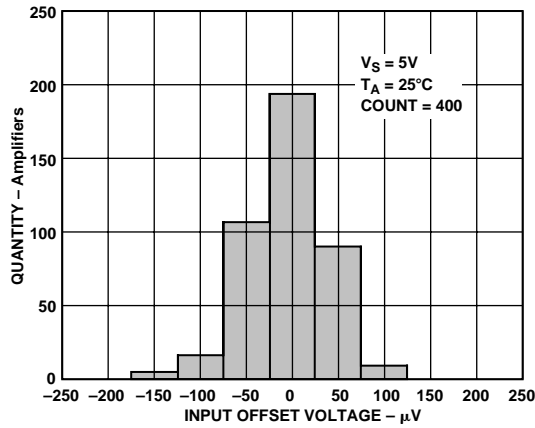

TPC 2. Input Offset Voltage Distribution

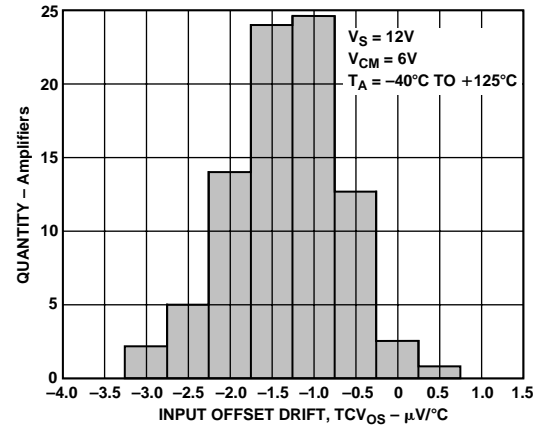

TPC 5. Input Offset Voltage Distribution (TCV_{OS})

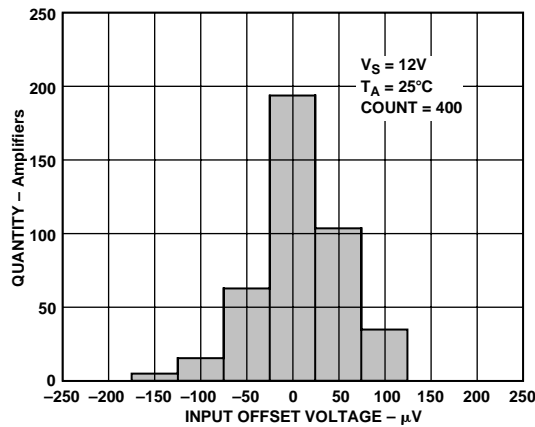

TPC 3. Input Offset Voltage Distribution

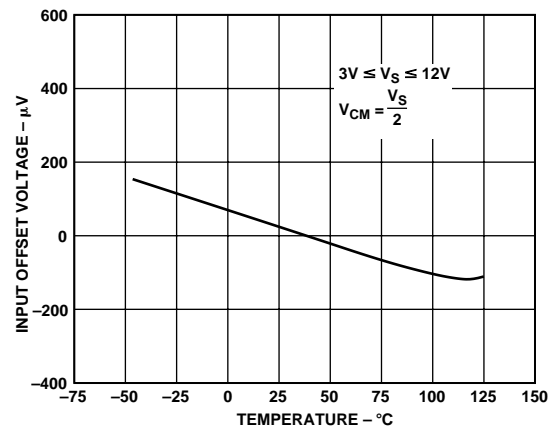

TPC 6. Input Offset Voltage vs. Temperature

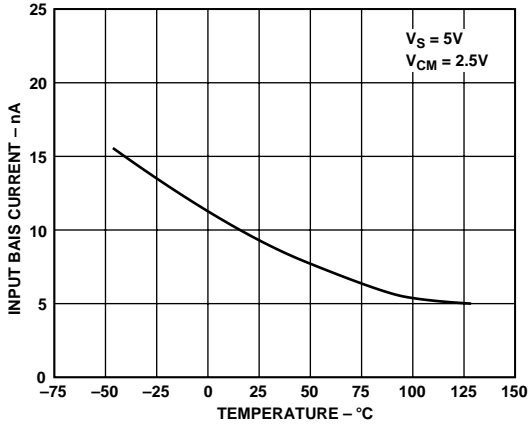

TPC 7. Input Bias Current vs. Temperature

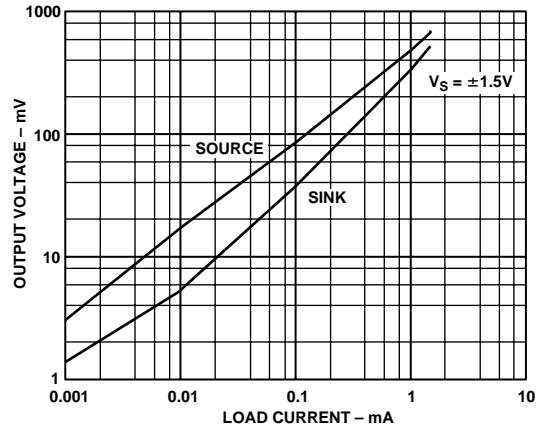

TPC 10. Output Voltage to Supply Rail vs. Load Current

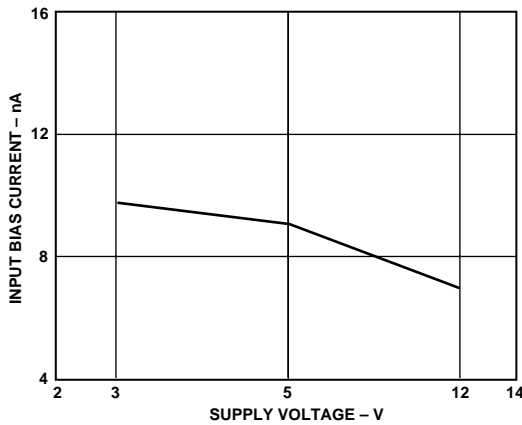

TPC 8. Input Bias Current vs. Supply Voltage

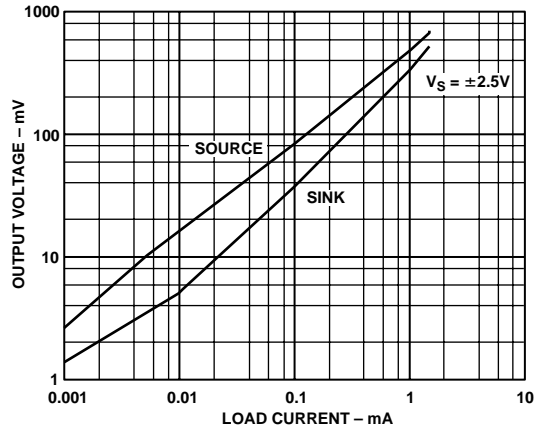

TPC 11. Output Voltage to Supply Rail vs. Load Current

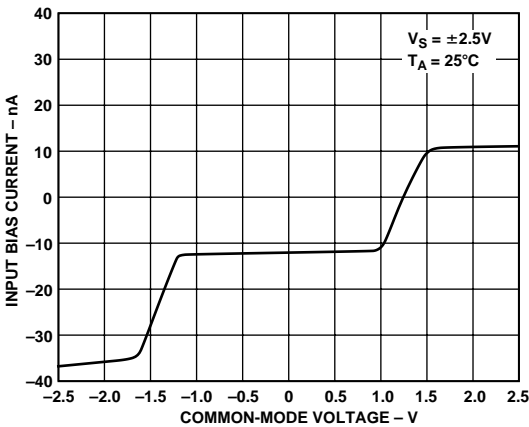

TPC 9. Input Bias Current vs. Common-Mode Voltage

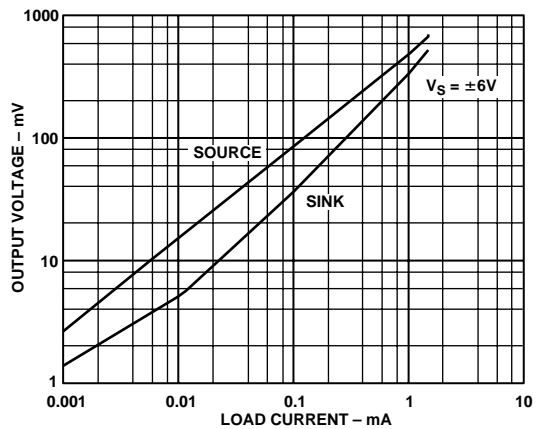

TPC 12. Output Voltage to Supply Rail vs. Load Current

OP196/OP296/OP496

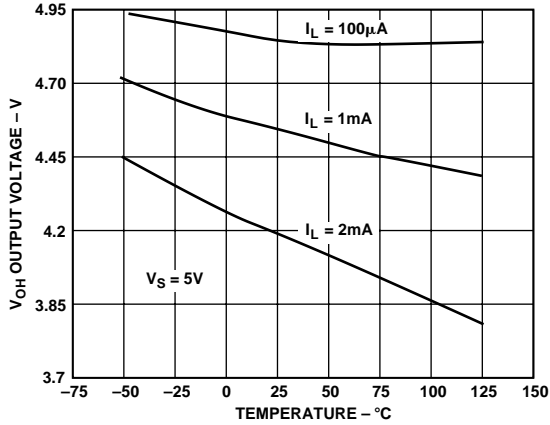

TPC 13. Output Voltage Swing vs. Temperature

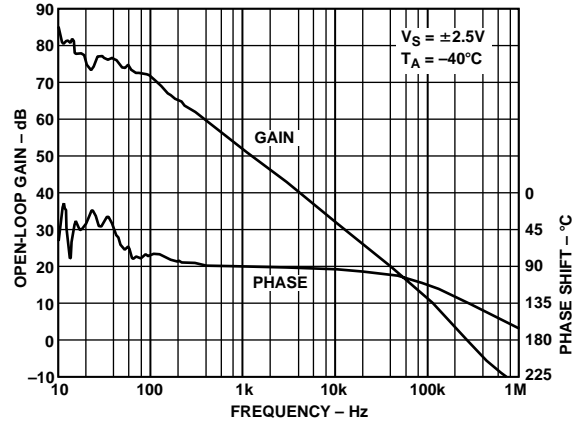

TPC 16. Open-Loop Gain and Phase vs. Frequency (No Load)

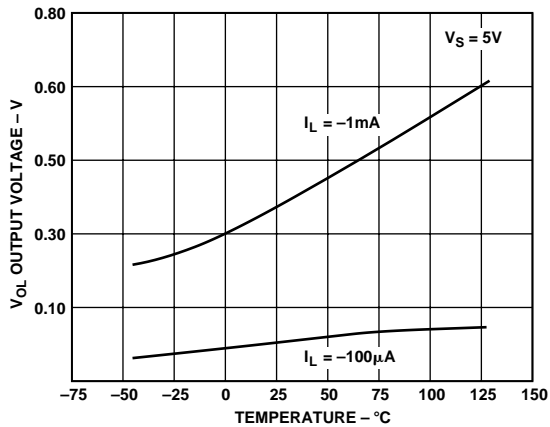

TPC 14. Output Voltage Swing vs. Temperature

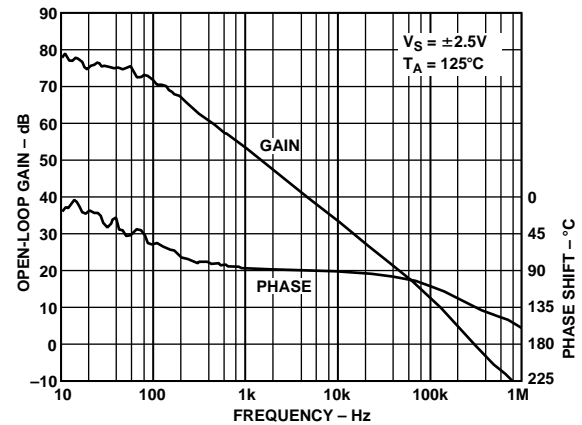

TPC 17. Open-Loop Gain and Phase vs. Frequency (No Load)

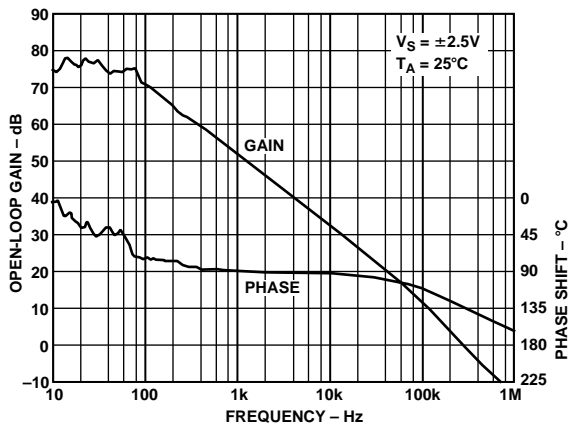

TPC 15. Open-Loop Gain and Phase vs. Frequency (No Load)

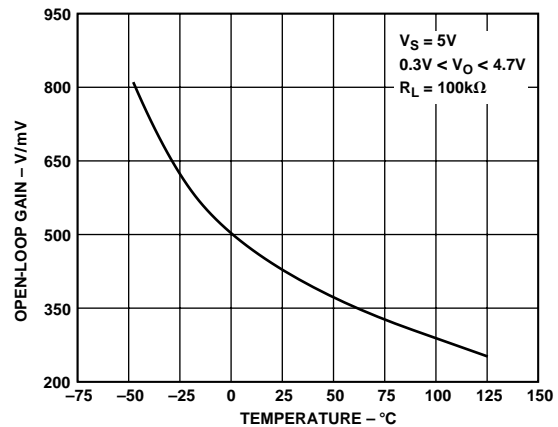

TPC 18. Open-Loop Gain vs. Temperature

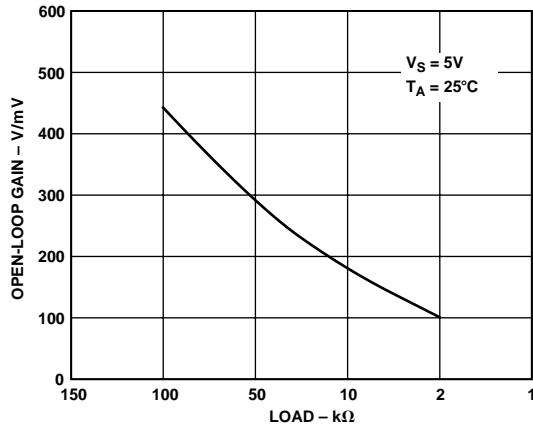

TPC 19. Open-Loop Gain vs. Resistive Load

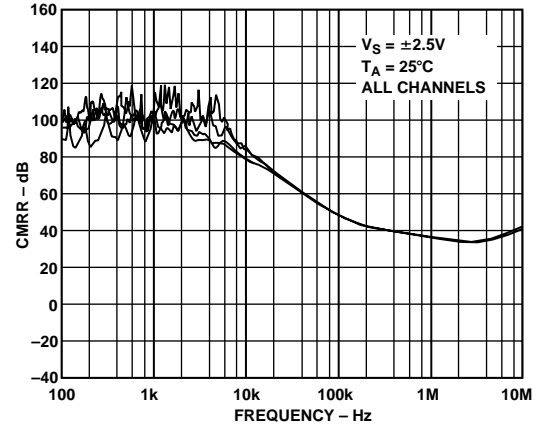

TPC 22. CMRR vs. Frequency

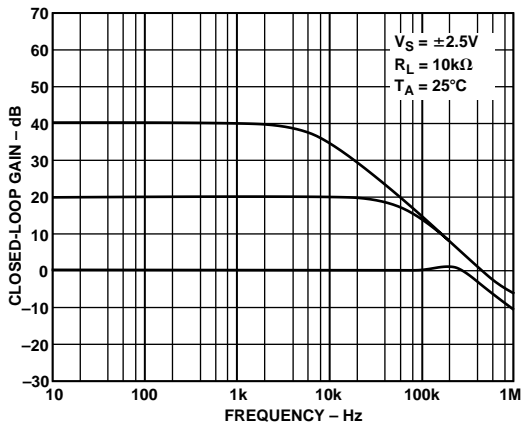

TPC 20. Closed-Loop Gain vs. Frequency

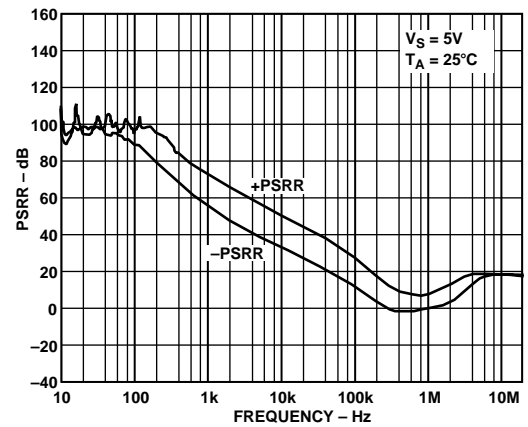

TPC 23. PSRR vs. Frequency

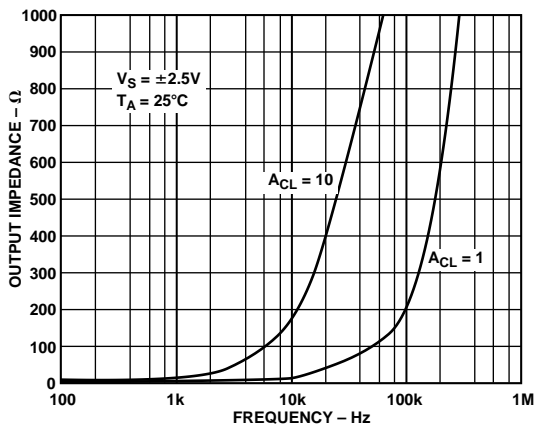

TPC 21. Output Impedance vs. Frequency

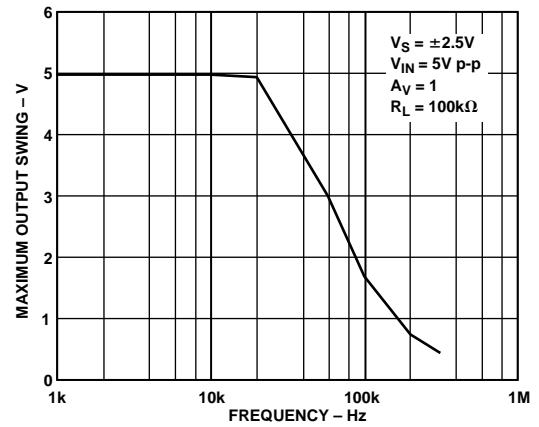

TPC 24. Maximum Output Swing vs. Frequency

OP196/OP296/OP496

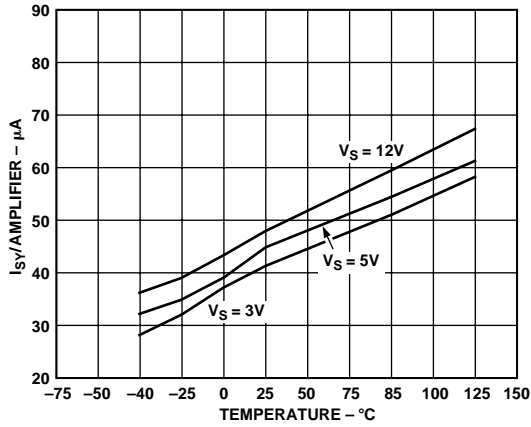

TPC 25. Supply Current/Amplifier vs. Temperature

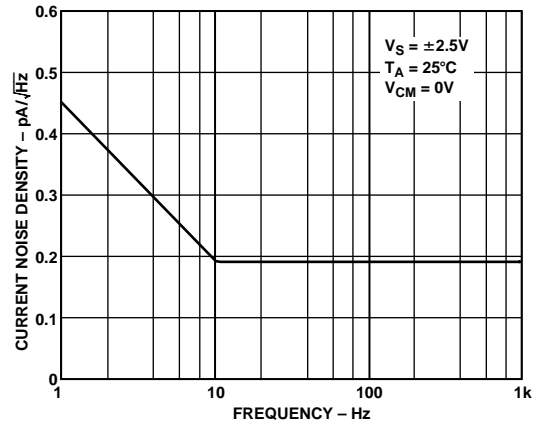

TPC 28. Input Bias Current Noise Density vs. Frequency

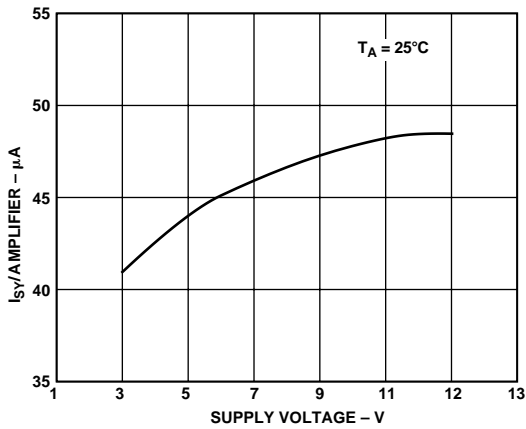

TPC 26. Supply Current/Amplifier vs. Supply Voltage

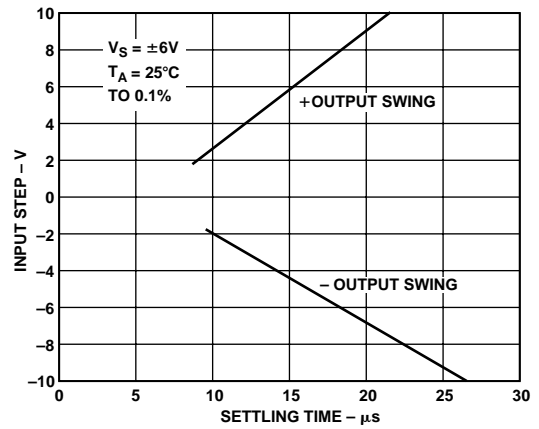

TPC 29. Settling Time to 0.1% vs. Step Size

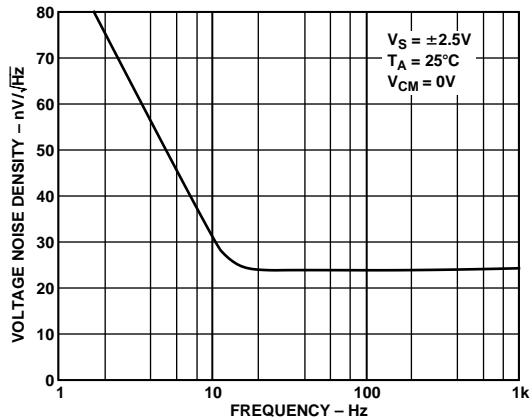

TPC 27. Voltage Noise Density vs. Frequency

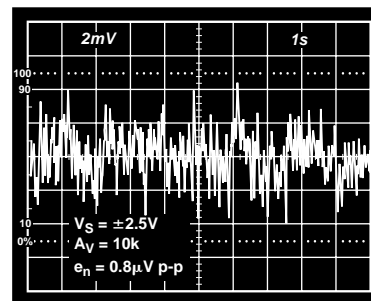

TPC 30. 0.1 Hz to 10 Hz Noise

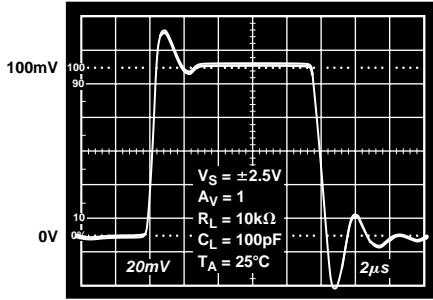

TPC 31. Small Signal Transient Response

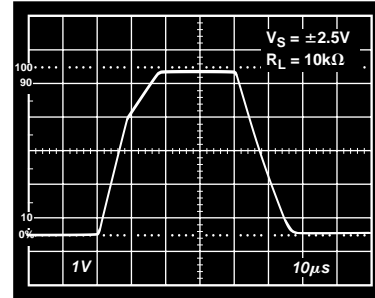

TPC 33. Large Signal Transient Response

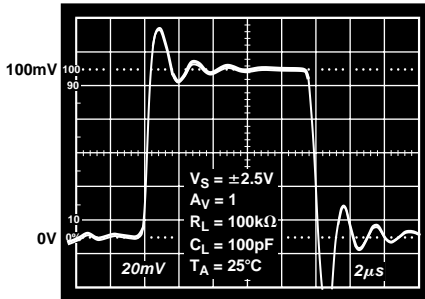

TPC 32. Small Signal Transient Response

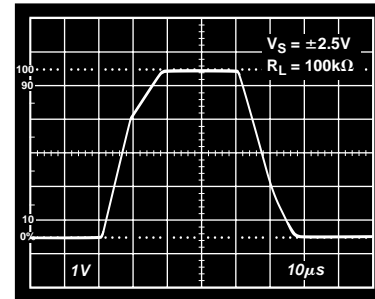

TPC 34. Large Signal Transient Response

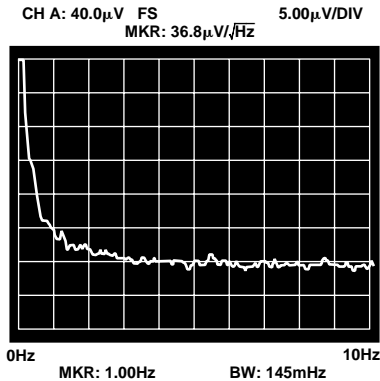

TPC 35. 1/f Noise Corner, $V_S = \pm 5 V, A_V = 1,000$

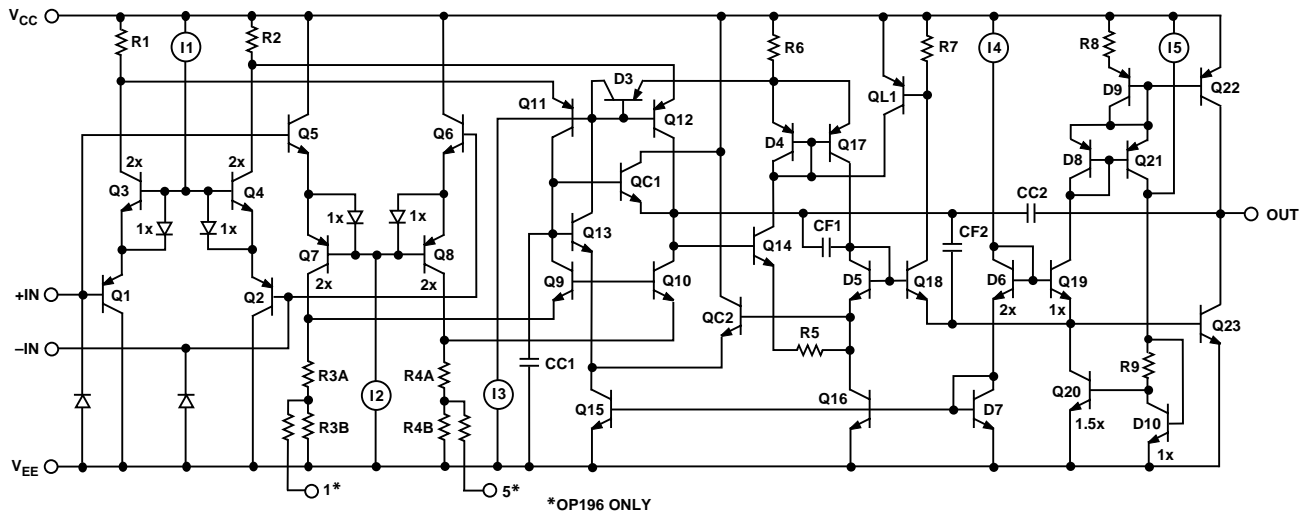

TPC 36. Simplified Schematic

OP196/OP296/OP496

APPLICATIONS INFORMATION

Functional Description

The OP196 family of operational amplifiers is comprised of single-supply, micropower, rail-to-rail input and output amplifiers. Input offset voltage (V_{OS}) is only 300 μ V maximum, while the output will deliver ± 5 mA to a load. Supply current is only 50 μ A, while bandwidth is over 450 kHz and slew rate is 0.3 V/ μ s. TPC 36 is a simplified schematic of the OP196—it displays the novel circuit design techniques used to achieve this performance.

Input Overvoltage Protection

The OPx96 family of op amps uses a composite PNP/NPN input stage. Transistor Q1 in Figure 36 has a collector-base voltage of 0 V if $+IN = V_{EE}$. If $+IN$ then exceeds V_{EE} , the junction will be forward biased and large diode currents will flow, which may damage the device. The same situation applies to $+IN$ on the base of transistor Q5 being driven above V_{CC} . Therefore, the inverting and noninverting inputs must not be driven above or below either supply rail unless the input current is limited.

Figure 1 shows the input characteristics for the OPx96 family. This photograph was generated with the power supply pins connected to ground and a curve tracer's collector output drive connected to the input. As shown in the figure, when the input voltage exceeds either supply by more than 0.6 V, internal pn-junctions energize and permit current flow from the inputs to the supplies. If the current is not limited, the amplifier may be damaged. To prevent damage, the input current should be limited to no more than 5 mA.

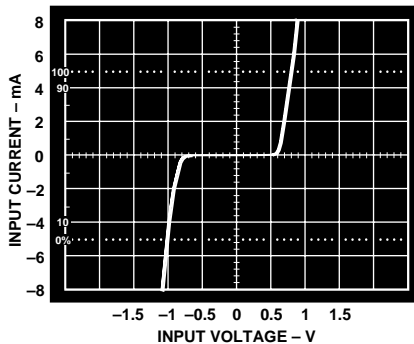

Figure 1. Input Overvoltage I-V Characteristics of the OPx96 Family

Output Phase Reversal

Some other operational amplifiers designed for single-supply operation exhibit an output voltage phase reversal when their inputs are driven beyond their useful common-mode range. Typically for single-supply bipolar op amps, the negative supply determines the lower limit of their common-mode range. With these common-mode limited devices, external clamping diodes are required to prevent input signal excursions from exceeding the device's negative supply rail (i.e., GND) and triggering output phase reversal.

The OPx96 family of op amps is free from output phase reversal effects due to its novel input structure. Figure 2 illustrates the performance of the OPx96 op amps when the input is driven beyond the supply rails. As previously mentioned, amplifier input current must be limited if the inputs are driven beyond

the supply rails. In the circuit of Figure 2, the source amplitude is ± 15 V, while the supply voltage is only ± 5 V. In this case, a 2 k Ω source resistor limits the input current to 5 mA.

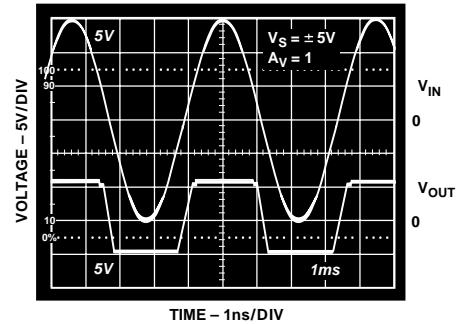

Figure 2. Output Voltage Phase Reversal Behavior

Input Offset Voltage Nulling

The OP196 provides two offset adjust terminals that can be used to null the amplifier's internal V_{OS} . In general, operational amplifier terminals should never be used to adjust system offset voltages. A 100 k Ω potentiometer, connected as shown in Figure 3, is recommended to null the OP196's offset voltage. Offset nulling does not adversely affect TCV_{OS} performance, providing that the trimming potentiometer temperature coefficient does not exceed ± 100 ppm/ $^{\circ}$ C.

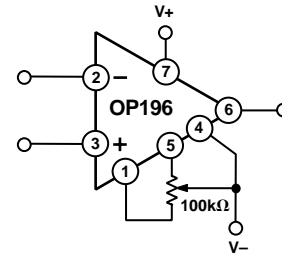

Figure 3. Offset Nulling Circuit

Driving Capacitive Loads

OP196 family amplifiers are unconditionally stable with capacitive loads less than 170 pF. When driving large capacitive loads in unity-gain configurations, an in-the-loop compensation technique is recommended, as illustrated in Figure 4.

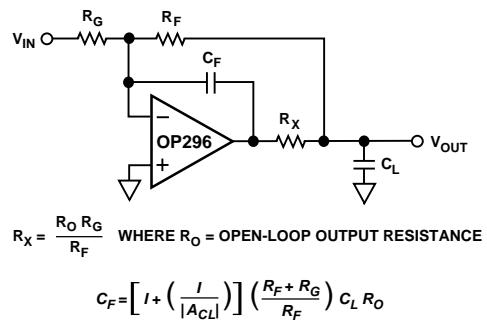

Figure 4. In-the-Loop Compensation Technique for Driving Capacitive Loads

A Micropower False-Ground Generator

Some single supply circuits work best when inputs are biased above ground, typically at 1/2 of the supply voltage. In these cases, a false-ground can be created by using a voltage divider buffered by an amplifier. One such circuit is shown in Figure 5.

This circuit will generate a false-ground reference at 1/2 of the supply voltage, while drawing only about 55 μ A from a 5 V supply. The circuit includes compensation to allow for a 1 μ F bypass capacitor at the false-ground output. The benefit of a large capacitor is that not only does the false-ground present a very low dc resistance to the load, but its ac impedance is low as well.

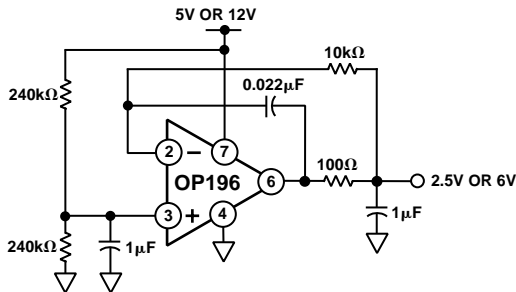

Figure 5. A Micropower False-Ground Generator

Single-Supply Half-Wave and Full-Wave Rectifiers

An OP296, configured as a voltage follower operating from a single supply, can be used as a simple half-wave rectifier in low frequency (<400 Hz) applications. A full-wave rectifier can be configured with a pair of OP296s as illustrated in Figure 6.

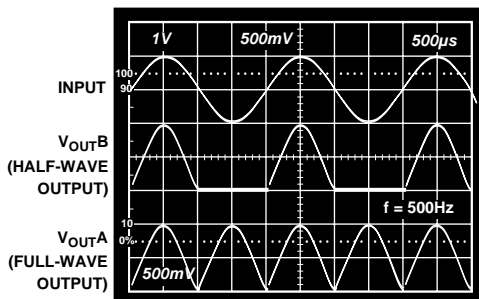
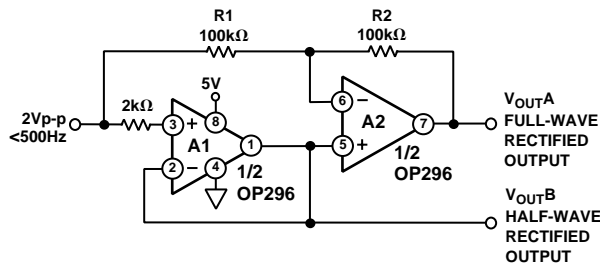

Figure 6. Single-Supply Half-Wave and Full-Wave Rectifiers Using an OP296

The circuit works as follows: When the input signal is above 0 V, the output of amplifier A1 follows the input signal. Since the noninverting input of amplifier A2 is connected to A1's output, op amp loop control forces A2's inverting input to the same potential. The result is that both terminals of R1 are at the

same potential and no current flows in R1. Since there is no current flow in R1, the same condition must exist in R2; thus, the output of the circuit tracks the input signal. When the input signal is below 0 V, the output voltage of A1 is forced to 0 V. This condition now forces A2 to operate as an inverting voltage follower because the noninverting terminal of A2 is also at 0 V. The output voltage of V_{OUTA} is then a full-wave rectified version of the input signal. A resistor in series with A1's noninverting input protects the ESD diodes when the input signal goes below ground.

Square Wave Oscillator

The oscillator circuit in Figure 7 demonstrates how a rail-to-rail output swing can reduce the effects of power supply variations on the oscillator's frequency. This feature is especially valuable in battery powered applications, where voltage regulation may not be available. The output frequency remains stable as the supply voltage changes because the RC charging current, which is derived from the rail-to-rail output, is proportional to the supply voltage. Since the Schmitt trigger threshold level is also proportional to supply voltage, the frequency remains relatively independent of supply voltage. For a supply voltage change from 9 V to 5 V, the output frequency only changes about 4 Hz. The slew rate of the amplifier limits the oscillation frequency to a maximum of about 200 Hz at a supply voltage of 5 V.

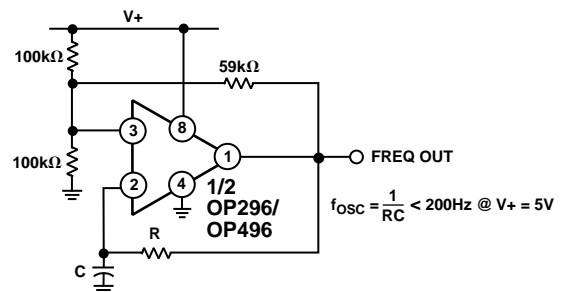

Figure 7. Square Wave Oscillator Has Stable Frequency Regardless of Supply Voltage Changes

A 3 V Low Dropout, Linear Voltage Regulator

Figure 8 shows a simple 3 V voltage regulator design. The regulator can deliver 50 mA load current while allowing a 0.2 V dropout voltage. The OP296's rail-to-rail output swing easily drives the MJE350 pass transistor without requiring special drive circuitry. With no load, its output can swing to less than the pass transistor's base-emitter voltage, turning the device nearly off. At full load, and at low emitter-collector voltages, the transistor beta tends to decrease. The additional base current is easily handled by the OP296 output.

The AD589 provides a 1.235 V reference voltage for the regulator. The OP296, operating with a noninverting gain of 2.43, drives the base of the MJE350 to produce an output voltage of 3.0 V. Since the MJE350 operates in an inverting (common-emitter) mode, the output feedback is applied to the OP296's noninverting input.

OP196/OP296/OP496

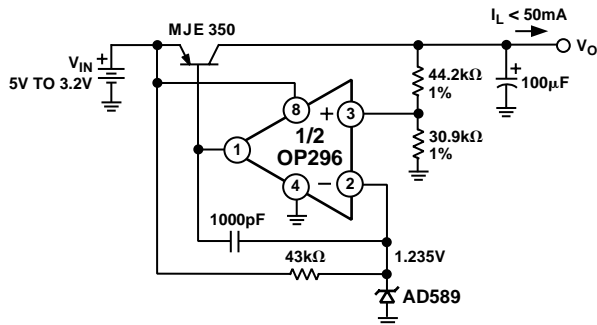

Figure 8. 3 V Low Dropout Voltage Regulator

Figure 9 shows the regulator's recovery characteristics when its output underwent a 20 mA to 50 mA step current change.

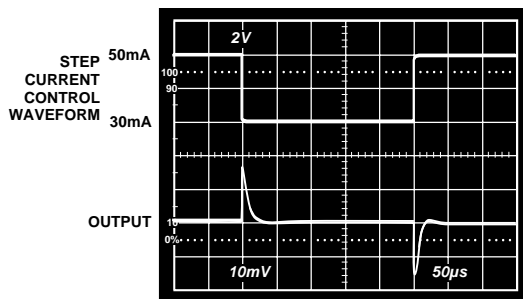

Figure 9. Output Step Load Current Recovery

Buffering a DAC Output

Multichannel TrimDACs® such as the AD8801/AD8803, are widely used for digital nulling and similar applications. These DACs have rail-to-rail output swings, with a nominal output resistance of 5 kΩ. If a lower output impedance is required, an OP296 amplifier can be added. Two examples are shown in Figure 10. One amplifier of an OP296 is used as a simple buffer to reduce the output resistance of DAC A. The OP296 provides rail-to-rail output drive while operating down to a 3 V supply and requiring only 50 μA of supply current.

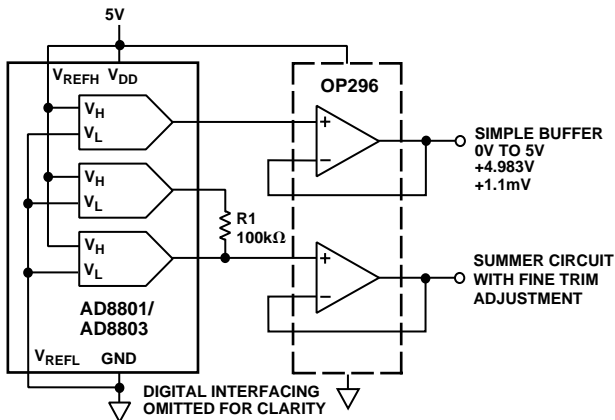

Figure 10. Buffering a TrimDAC Output

The next two DACs, B and C, sum their outputs into the other OP296 amplifier. In this circuit DAC C provides the coarse output voltage setting and DAC B is used for fine adjustment. The insertion of R1 in series with DAC B attenuates its contribution to the voltage sum node at the DAC C output.

A High-Side Current Monitor

In the design of power supply control circuits, a great deal of design effort is focused on ensuring a pass transistor's long-term reliability over a wide range of load current conditions. As a result, monitoring and limiting device power dissipation is of prime importance in these designs. The circuit illustrated in Figure 11 is an example of a 5 V, single-supply high-side current monitor that can be incorporated into the design of a voltage regulator with fold-back current limiting or a high current power supply with crowbar protection. This design uses an OP296's rail-to-rail input voltage range to sense the voltage drop across a 0.1 Ω current shunt. A p-channel MOSFET is used as the feedback element in the circuit to convert the op amp's differential input voltage into a current. This current is then applied to R2 to generate a voltage that is a linear representation of the load current. The transfer equation for the current monitor is given by:

$$\text{Monitor Output} = R2 \times \left(\frac{R_{\text{SENSE}}}{R1} \right) \times I_L$$

For the element values shown, the Monitor Output's transfer characteristic is 2.5 V/A.

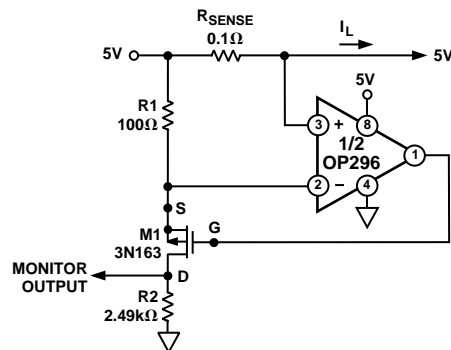

Figure 11. A High-Side Load Current Monitor

A Single-Supply RTD Amplifier

The circuit in Figure 12 uses three op amps on the OP496 to produce a bridge driver for an RTD amplifier while operating from a single 5 V supply. The circuit takes advantage of the OP496's wide output swing to generate a bridge excitation voltage of 3.9 V. An AD589 provides a 1.235 V reference for the bridge current. Op amp A1 drives the bridge to maintain 1.235 V across the parallel combination of the 6.19 kΩ and 2.55 MΩ resistors, which generates a 200 μA current source. This current divides evenly and flows through both halves of the bridge. Thus, 100 μA flows through the RTD to generate an output voltage which is proportional to its resistance. For improved accuracy, a 3-wire RTD is recommended to balance the line resistance in both 100 Ω legs of the bridge.

OP196/OP296/OP496

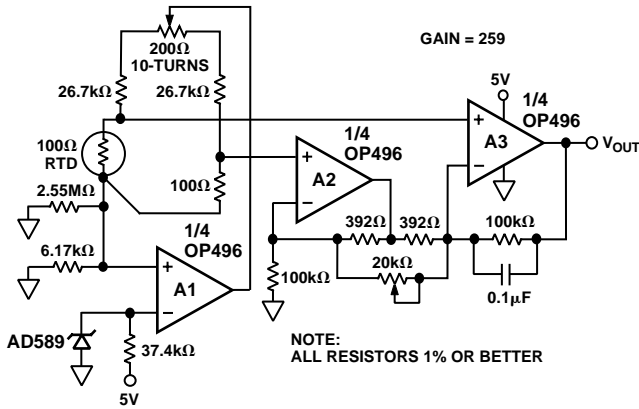

Figure 12. A Single-Supply RTD Amplifier

Amplifiers A2 and A3 are configured in a two op amp instrumentation amplifier configuration. For ease of measurement, the IA resistors are chosen to produce a gain of 259, so that each 1°C increase in temperature results in a 10 mV increase in the output voltage. To reduce measurement noise, the bandwidth of the amplifier is limited. A 0.1 μF capacitor, connected in parallel with the 100 kΩ resistor on amplifier A3, creates a pole at 16 Hz.

```

* OP496 SPICE Macro-model      REV. C, 5/95
*                               ARG / ADSC
*
* Copyright 1995 by Analog Devices, Inc.
*
* Refer to "README.DOC" file for License Statement.
* Use of this model indicates your acceptance of the
* terms and provisions in the License Statement.
*
* Node assignments
*
*                               Noninverting input
*                               Inverting input
*                               Positive supply
*                               Negative supply
*                               Output
*
.SUBCKT OP496      1      2      99      50      49
*
* INPUT STAGE
*
IREF  21      50      1U
QB1   21      21      99      99      QP      1
QB2   22      21      99      99      QP      1
QB3   4       21      99      99      QP      1.5
QB4   22      22      50      50      QN      2
QB5   11      22      50      50      QN      3
Q1    5       4       7       50      QN      2
Q2    6       4       8       50      QN      2
Q3    4       4       7       50      QN      1
Q4    4       4       8       50      QN      1
Q5    50      1       7       99      QP      2
Q6    50      3       8       99      QP      2
EOS   3       2       POLY(1) (17,98) 35U 1
Q7    99      1       9       50      QN      2
Q8    99      3       10      50      QN      2
Q9    12      11      9       99      QP      2
Q10   13      11      10      99      QP      2
Q11   11      11      9       99      QP      1
Q12   11      11      10      99      QP      1
R1    99      5       50K
R2    99      6       50K
R3    12      50      50K
R4    13      50      50K
IOS   1       2       0.75N
C10   5       6       3.183P
C11   12      13      3.183P

```

```

CIN  1      2      1P
*
* GAIN STAGE
*
EREF  98      0      POLY(2) (99,0) (50,0) 0 0.5 0.5
G1    98      15      POLY(2) (6,5) (13,12) 0 10U 10U
R10   15      98      251.641MEG
CC    15      49      8P
D1    15      99      DX
D2    50      15      DX
*
* COMMON-MODE STAGE
*
ECM   16      98      POLY(2) (1,98) (2,98) 0 0.5 0.5
R11   16      17      1MEG
R12   17      98      10
*
* OUTPUT STAGE
*
ISY   99      50      20U
EIN   35      50      POLY(1) (15,98) 1.42735 1
Q24   37      35      36      50      QN      1
QD4   37      37      38      99      QP      1
Q27   40      37      38      99      QP      1
R5    36      39      150K
R6    99      38      45K
Q26   39      42      50      50      QN      3
QD5   40      40      39      50      QN      1
Q28   41      40      44      50      QN      1
QL1   37      41      99      99      QP      1
R7    99      41      10.7K
I4    99      43      2U
QD7   42      42      50      50      QN      2
QD6   43      43      42      50      QN      2
Q29   47      43      44      50      QN      1
Q30   44      45      50      50      QN      1.5
QD10  45      46      50      50      QN      1
R9    45      46      175
Q31   46      47      48      99      QP      1
QD8   47      47      48      99      QP      1
QD9   48      48      51      99      QP      5
R8    99      51      2.9K
I5    99      46      1U
Q32   49      48      99      99      QP      10
Q33   49      44      50      50      QN      4
.MODEL DX D()
.MODEL QN NPN(BF=120 VAF=100)
.MODEL QP PNP(BF=80 VAF=60)
.ENDS

```

OUTLINE DIMENSIONS

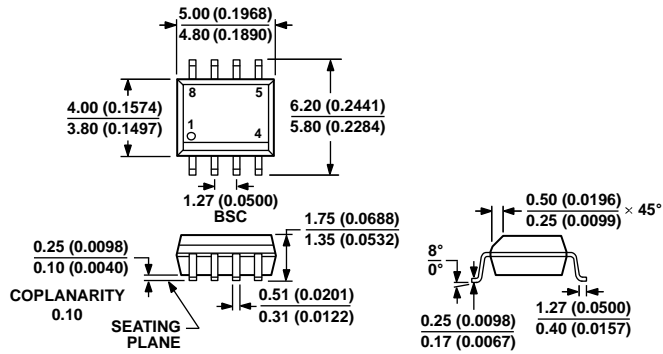

COMPLIANT TO JEDEC STANDARDS MS-012-AA

CONTROLLING DIMENSIONS ARE IN MILLIMETERS; INCH DIMENSIONS (IN PARENTHESES) ARE ROUNDED-OFF MILLIMETER EQUIVALENTS FOR REFERENCE ONLY AND ARE NOT APPROPRIATE FOR USE IN DESIGN.

Figure 13. 8-Lead Standard Small Outline Package [SOIC_N] Narrow Body (R-8)

Dimensions shown in millimeters and (inches)

012407-A

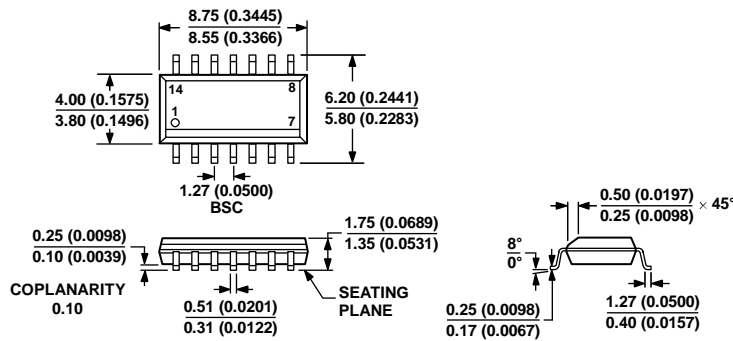

COMPLIANT TO JEDEC STANDARDS MS-012-AB

CONTROLLING DIMENSIONS ARE IN MILLIMETERS; INCH DIMENSIONS (IN PARENTHESES) ARE ROUNDED-OFF MILLIMETER EQUIVALENTS FOR REFERENCE ONLY AND ARE NOT APPROPRIATE FOR USE IN DESIGN.

Figure 14. 14-Lead Standard Small Outline Package [SOIC_N] Narrow Body (R-14)

Dimensions shown in millimeters and (inches)

068606-A

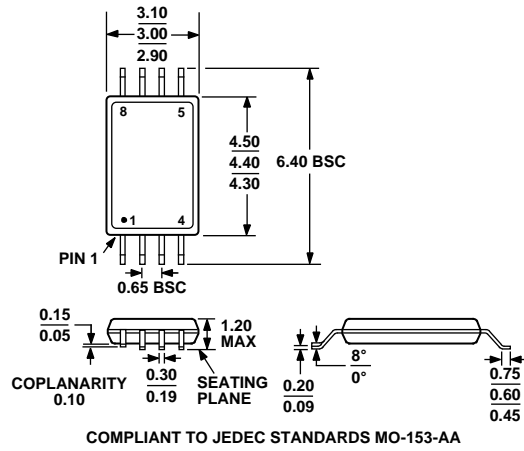

Figure 15. 8-Lead Thin Shrink Small Outline Package [TSSOP] (RU-8)
Dimensions shown in millimeters

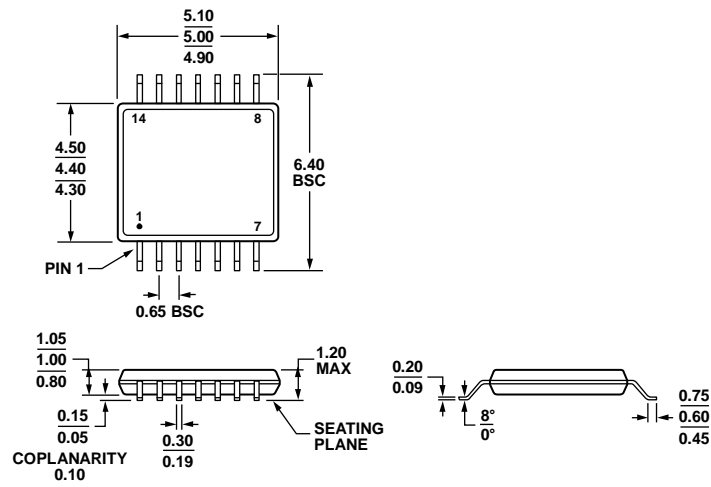

Figure 16. 14-Lead Thin Shrink Small Outline Package (RU-14)
Dimensions shown in millimeters

061908-A

OP196/OP296/OP496

ORDERING GUIDE

Model ^{1,2}	Temperature Range	Package Description	Package Option
OP196GSZ	-40°C to +85°C (Ambient)	8-Lead SOIC_N	R-8
OP196GSZ-REEL	-40°C to +85°C (Ambient)	8-Lead SOIC_N	R-8
OP196GSZ-REEL7	-40°C to +85°C (Ambient)	8-Lead SOIC_N	R-8
OP296GSZ	-40°C to +85°C (Ambient)	8-Lead SOIC_N	R-8
OP296GSZ-REEL	-40°C to +85°C (Ambient)	8-Lead SOIC_N	R-8
OP296GSZ-REEL7	-40°C to +85°C (Ambient)	8-Lead SOIC_N	R-8
OP296HRUZ-REEL	-40°C to +85°C (Ambient)	8-Lead TSSOP	RU-8
OP496GS	-40°C to +85°C (Ambient)	14-Lead SOIC_N	R-14
OP496GS-REEL	-40°C to +85°C (Ambient)	14-Lead SOIC_N	R-14
OP496GS-REEL7	-40°C to +85°C (Ambient)	14-Lead SOIC_N	R-14
OP496GSZ	-40°C to +85°C (Ambient)	14-Lead SOIC_N	R-14
OP496GSZ-REEL	-40°C to +85°C (Ambient)	14-Lead SOIC_N	R-14
OP496GSZ-REEL7	-40°C to +85°C (Ambient)	14-Lead SOIC_N	R-14
OP496HRUZ-REEL	-40°C to +85°C (Ambient)	14-Lead TSSOP	RU-14

¹ Z = RoHS Compliant Part.

² Note OP496GS, OP496GS-REEL, and OP496GS-REEL7 are not RoHS compliant parts.

REVISION HISTORY

9/11—Rev. D to Rev. E

Changes to General Description Section 1

Changes to Electrical Specifications Table (@ $V_s = 5.0$ V),
Output Voltage Swing High and Output Swing Low Parameters,
Conditions Column 2

Change to Electrical Specifications Table (@ $V_s = 12.0$ V),
Output Swing Low Parameter, Conditions Column 4

Changes to Ordering Guide 18

12/10—Rev. C to Rev. D

Change to Data Sheet Title 1

Deleted DIP Pin Configuration Figures 1

Changes to Absolute Maximum Ratings Table and Package
Type Table, Moved Ordering Guide 5

Updated Outline Dimensions 16



Changes to Ordering Guide 16

1/02—Rev. B to Rev. C

Edits to Typical Performance Characteristics 10

Looking for pricing, stock, or lifecycle information?

Click below to explore more details on WIN SOURCE:

-  [View OP496GS on WIN SOURCE](#)
-  [Analog Devices Inc. Information](#)

Optimize Your Supply Chain with WIN SOURCE Solutions

-  Global Sourcing Solution
-  Obsolete Management
-  Cost Control Management
-  Shortage Management
-  Alternative Solution
-  Excess Inventory Management