



**THE DATASHEET OF
AH276Q-PG-B-B**



Description

AH276 are integrated Hall sensors with output drivers, mainly designed for electronic commutation of brush-less DC Fan. This IC internally includes the regulator, protecting diode, Hall plate, amplifier, comparator, and a pair of complementary open-collector outputs (**DO**, **DOB**).

While the magnetic flux density (**B**) is larger than operate point (**Bop**), **DO** will turn on (low), and meanwhile **DOB** will turn off (high). Each output is latched until **B** is lower than release point (**Brp**), and then **DO**, **DOB** transfer each state.

For DC fan application, sometimes need to test power reverse connection condition. Internal diode only protects chip-side but not for coil-side. If necessary, add one external diode to block the reverse current from coil-side.

Features

- On-chip Hall sensor with two different sensitivity and hysteresis settings for AH276
- Built-in protecting diode only for chip reverse power connecting
- -20°C to +85°C operating temperature
- Lead Free Package: SIP-4L
- SIP-4L: Available in “Green” Molding Compound (No Br, Sb)
- **Lead-Free Finish; RoHS Compliant (Notes 1 & 2)**
- **Halogen and Antimony Free. “Green” Device (Note 3)**

- Notes:
1. EU Directive 2002/95/EC (RoHS) & 2011/65/EU (RoHS 2) compliant. All applicable RoHS exemptions applied.
 2. See http://www.diodes.com/quality/lead_free.html for more information about Diodes Incorporated’s definitions of Halogen- and Antimony-free, “Green” and Lead-free.
 3. Halogen- and Antimony-free “Green” products are defined as those which contain <900ppm bromine, <900ppm chlorine (<1500ppm total Br + Cl) and <1000ppm antimony compounds.

Pin Assignments

(Top View)

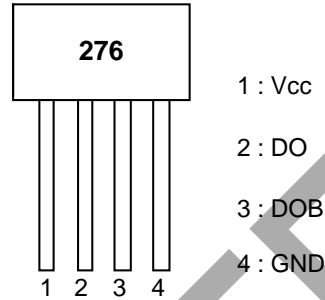

Applications

- Dual-coil Brush-less DC Motor
- Dual-coil Brush-less DC Fan
- Revolution Counting
- Speed Measurement

Typical Applications Circuit

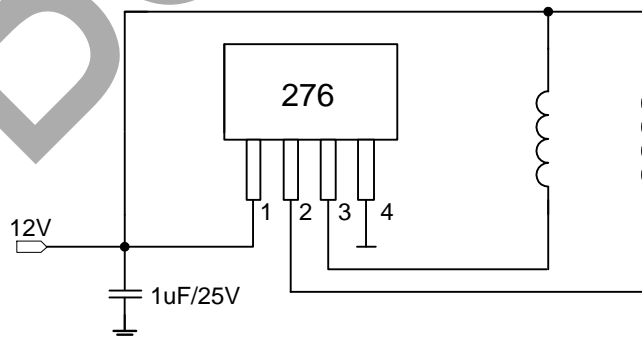

Brush-less DC Fan

OBSOLETE – PART DISCONTINUED

OBSOLETE - PART DISCONTINUED

Pin Descriptions

Pin Name	P/I/O	Pin #	Function
Vcc	P	1	Power Supply Input
DO	O	2	Output Pin
DOB	O	3	Output Pin
GND	P	4	Ground

Functional Block Diagram

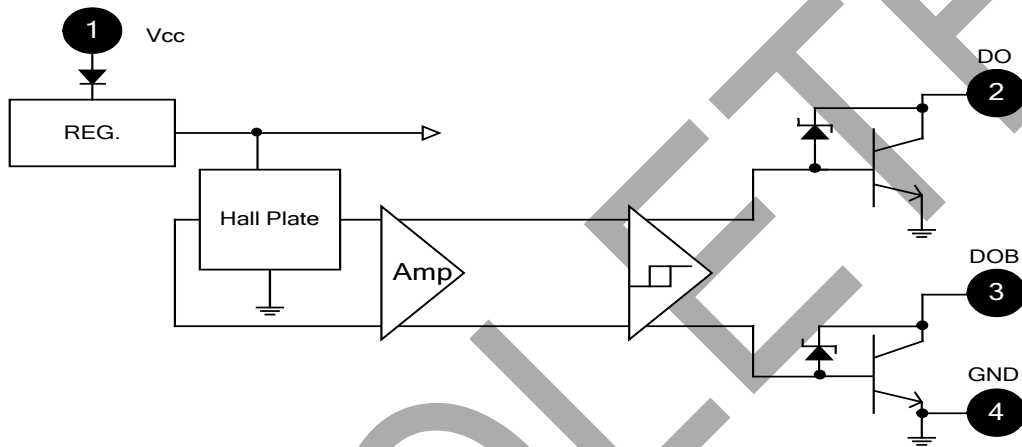

Absolute Maximum Ratings (@T_A = +25°C, unless otherwise specified.)

Symbol	Parameter	Rating	Unit
V _{CC}	Supply Voltage	20	V
V _{RCC}	Reverse VCC Polarity Voltage	-20	V
B	Magnetic Flux Density	Unlimited	
I _o	Output "on" Current (Note 3)	Continuous	0.4
		Hold	0.5
		Peak (Start Up)	0.7
T _s	Storage Temperature Range	-65 ~ +150	°C
PD	Package Power Dissipation (SIP-4L)	550	mW
T _J	Maximum Junction Temperature	+150	°C
θ _{JA}	Thermal Resistance Junction-to-Ambient (SIP-4L)	227	°C/W
θ _{JC}	Thermal Resistance Junction-to-Case (SIP-4L)	49	°C/W

Note: 3. P_o shall be within Safety Operation Area.

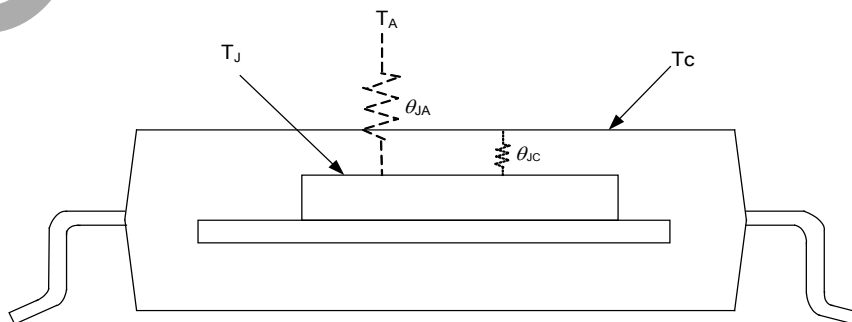

Recommended Operating Conditions (@T_A = +25°C, unless otherwise specified.)

Symbol	Parameter	Conditions	Min	Max	Unit
V _{CC}	Supply Voltage (Note 4)	Operating	3.5	20	V
T _A	Operating Ambient Temperature	Operating	-20	+85	°C

Note: 4. The output DO/DOB is switching as magnetic field change (S>300G, N<-300G).

Electrical Characteristics (@T_A = +25°C, unless otherwise specified.)

Symbol	Parameter	Conditions	Min	Typ	Max	Unit
V _Z	Output Zener Breakdown		—	35	—	V
V _{CE(SAT)}	Output Saturation Voltage	V _{CC} = 14V, I _L = 400mA	—	0.6	0.9	V
I _{CEX}	Output Leakage Current	V _{CE} = 14V, V _{CC} = 14V	—	<0.1	10	µA
I _{CC}	Supply Current	V _{CC} = 20V, Output Open	7	16	25	mA

Magnetic Characteristics (Note 5) (@T_A = +25°C, V_{CC} = 14V, unless otherwise specified.)

A grade

Symbol	Characteristic	Min	Typ	Max	Unit
B _{op}	Operate Point	10	—	50	Gauss
B _{rp}	Release Point	-50	—	-10	Gauss
B _{hy}	Hysteresis	—	75	—	Gauss

B grade

Symbol	Characteristic	Min	Typ	Max	Unit
B _{op}	Operate Point	5	—	70	Gauss
B _{rp}	Release Point	-70	—	-5	Gauss
B _{hy}	Hysteresis	—	75	—	Gauss

C grade

Symbol	Characteristic	Min	Typ	Max	Unit
B _{op}	Operate Point	—	—	100	Gauss
B _{rp}	Release Point	-100	—	—	Gauss
B _{hy}	Hysteresis	—	75	—	Gauss

Note: 5. Magnetic characteristics are for design information, which will vary with supply voltage, operating temperature and after soldering.

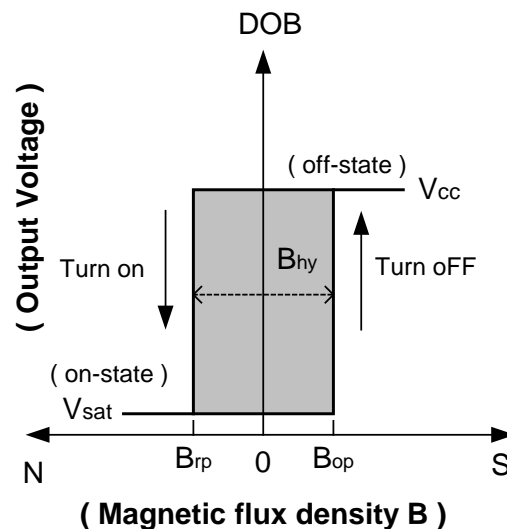
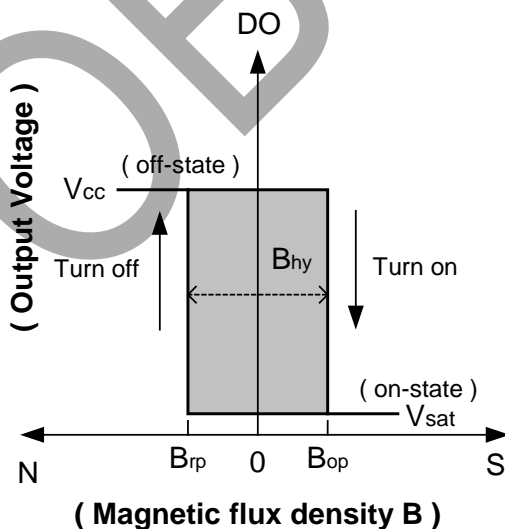

OBSOLETE - PART DISCONTINUED

Performance Characteristics

T_A (°C)	25	50	60	70	80	85	90	95	100
P_D (mW)	550	440	396	352	308	286	264	242	220
T_A (°C)	105	110	115	120	125	130	135	140	150
P_D (mW)	198	176	154	132	110	88	66	44	0

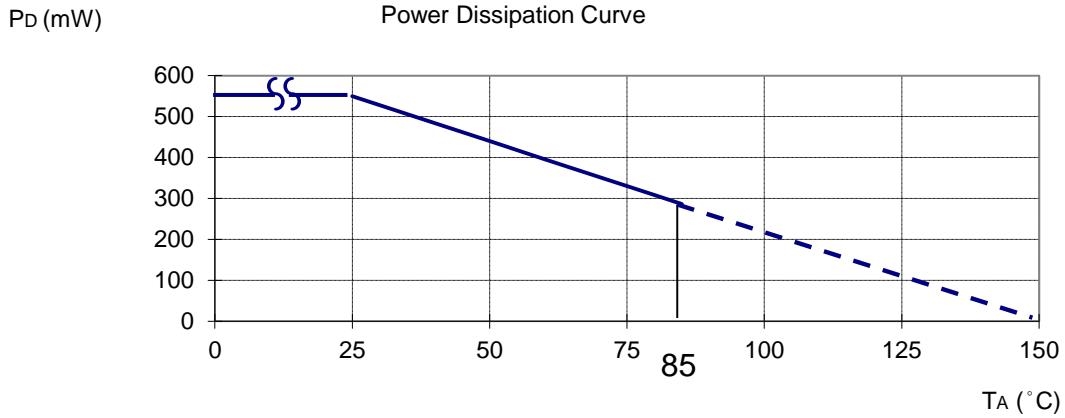

Ordering Information

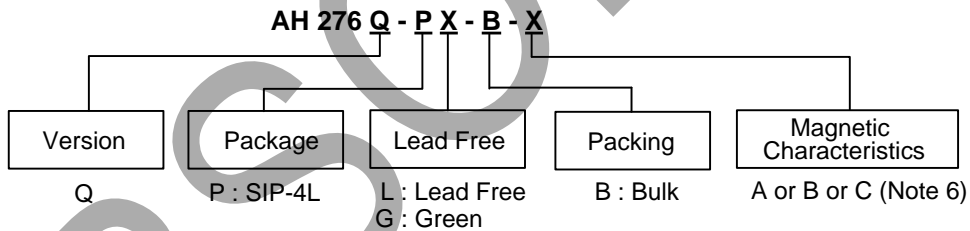

Part Number	Package Code	Packaging	Bulk		Magnetic Characteristics
			Quantity	Part Number Suffix	
AH276Q-PL-B-A	P	SIP-4L	1000	-B	A
AH276Q-PL-B-B	P	SIP-4L	1000	-B	B
AH276Q-PL-B-C	P	SIP-4L	1000	-B	C
AH276Q-PG-B-A	P	SIP-4L	1000	-B	A
AH276Q-PG-B-B	P	SIP-4L	1000	-B	B
AH276Q-PG-B-C	P	SIP-4L	1000	-B	C

Note: 6. Please refer to page 3 (Magnetic Characteristics table).

OBSOLETE - PART DISCONTINUED

Marking Information

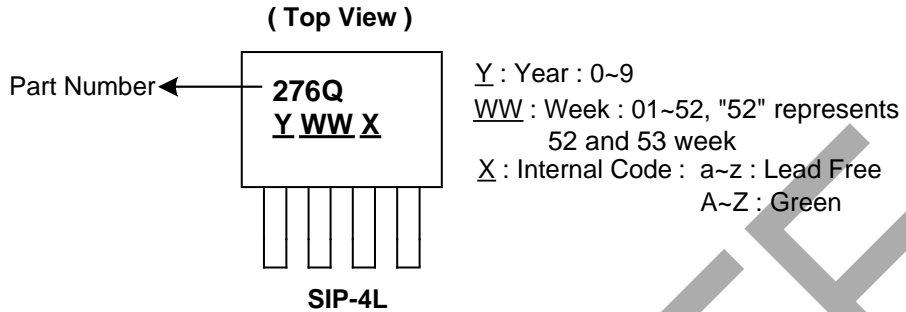

Package Outline Dimensions (All dimensions in mm.)

Please see AP02002 at <http://www.diodes.com/datasheets/ap02002.pdf> for latest version.

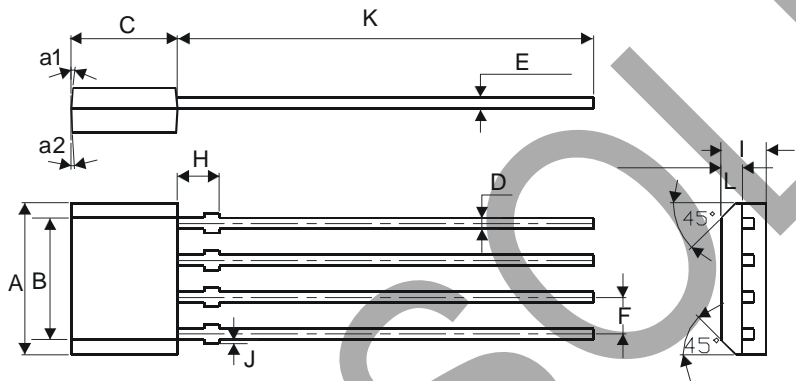

SIP-4		
Dim	Min	Max
A	5.12	5.32
B	4.10	4.30
C	3.55	3.75
D	0.38	0.44
E	0.35	0.41
F	1.24	1.30
H	1.32	1.52
I	1.45	1.65
J	0.00	0.2
K	13.00	15.5
L	0.63	0.83
a1	3°	5°
a2	4°	7°
All Dimensions in mm		

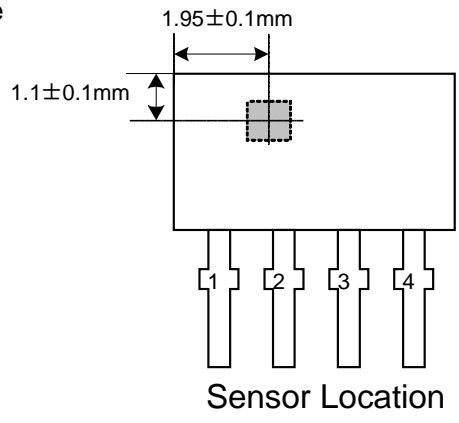
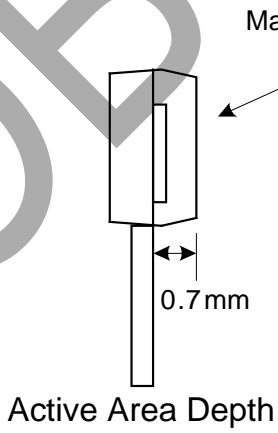

OBSOLETE - PART DISCONTINUED

IMPORTANT NOTICE

DIODES INCORPORATED MAKES NO WARRANTY OF ANY KIND, EXPRESS OR IMPLIED, WITH REGARDS TO THIS DOCUMENT, INCLUDING, BUT NOT LIMITED TO, THE IMPLIED WARRANTIES OF MERCHANTABILITY AND FITNESS FOR A PARTICULAR PURPOSE (AND THEIR EQUIVALENTS UNDER THE LAWS OF ANY JURISDICTION).

Diodes Incorporated and its subsidiaries reserve the right to make modifications, enhancements, improvements, corrections or other changes without further notice to this document and any product described herein. Diodes Incorporated does not assume any liability arising out of the application or use of this document or any product described herein; neither does Diodes Incorporated convey any license under its patent or trademark rights, nor the rights of others. Any Customer or user of this document or products described herein in such applications shall assume all risks of such use and will agree to hold Diodes Incorporated and all the companies whose products are represented on Diodes Incorporated website, harmless against all damages.

Diodes Incorporated does not warrant or accept any liability whatsoever in respect of any products purchased through unauthorized sales channel. Should Customers purchase or use Diodes Incorporated products for any unintended or unauthorized application, Customers shall indemnify and hold Diodes Incorporated and its representatives harmless against all claims, damages, expenses, and attorney fees arising out of, directly or indirectly, any claim of personal injury or death associated with such unintended or unauthorized application.

Products described herein may be covered by one or more United States, international or foreign patents pending. Product names and markings noted herein may also be covered by one or more United States, international or foreign trademarks.

This document is written in English but may be translated into multiple languages for reference. Only the English version of this document is the final and determinative format released by Diodes Incorporated.

LIFE SUPPORT

Diodes Incorporated products are specifically not authorized for use as critical components in life support devices or systems without the express written approval of the Chief Executive Officer of Diodes Incorporated. As used herein:

A. Life support devices or systems are devices or systems which:

1. are intended to implant into the body, or
2. support or sustain life and whose failure to perform when properly used in accordance with instructions for use provided in the labeling can be reasonably expected to result in significant injury to the user.

B. A critical component is any component in a life support device or system whose failure to perform can be reasonably expected to cause the failure of the life support device or to affect its safety or effectiveness.



Customers represent that they have all necessary expertise in the safety and regulatory ramifications of their life support devices or systems, and acknowledge and agree that they are solely responsible for all legal, regulatory and safety-related requirements concerning their products and any use of Diodes Incorporated products in such safety-critical, life support devices or systems, notwithstanding any devices- or systems-related information or support that may be provided by Diodes Incorporated. Further, Customers must fully indemnify Diodes Incorporated and its representatives against any damages arising out of the use of Diodes Incorporated products in such safety-critical, life support devices or systems.

Copyright © 2013, Diodes Incorporated

www.diodes.com

Looking for pricing, stock, or lifecycle information?

Click below to explore more details on WIN SOURCE:

-  [View AH276Q-PG-B-B on WIN SOURCE](#)
-  [Diodes Incorporated Information](#)

Optimize Your Supply Chain with WIN SOURCE Solutions

-  Global Sourcing Solution
-  Obsolete Management
-  Cost Control Management
-  Shortage Management
-  Alternative Solution
-  Excess Inventory Management