

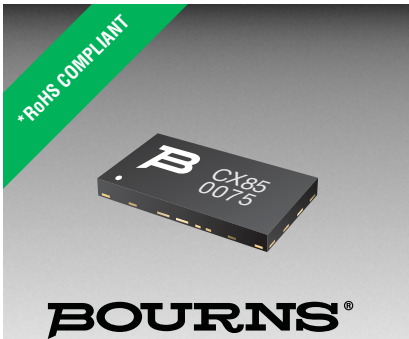

**THE DATASHEET OF
TBU-CX085-VTC-WH**





Features

- Superior circuit protection
- Overcurrent and overvoltage protection
- Blocks surges up to rated limits
- High-speed performance
- Small SMT package
- RoHS compliant*
- Agency recognition:



The TBU-CX Series is obsolete and not recommended for new designs. The **TBU-CA Series** is the recommended alternative - see data sheet for specifications.

TBU-CX Series - TBU® High-Speed Protectors

General Information

The TBU-CX Series of Bourns® TBU® products are low capacitance dual bidirectional high-speed protection components, constructed using MOSFET semiconductor technology, and designed to protect against faults caused by short circuits, AC power cross, induction and lightning surges.

The TBU® high-speed protector placed in the system circuit will monitor the current with the MOSFET detection circuit triggering to provide an effective barrier behind which sensitive electronics will not be exposed to large voltages or currents during surge events. The TBU® device is provided in a surface mount DFN package and meets industry standard requirements such as RoHS and Pb Free solder reflow profiles.

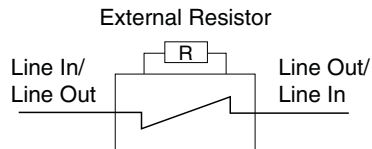

Agency Approval

| Description | |
|-------------|----------------------|
| UL | File Number: E315805 |

Absolute Maximum Ratings (@ T_A = 25 °C Unless Otherwise Noted)

| Symbol | Parameter | Part Number | Value | Unit |
|-------------------|--|------------------|-------------|------|
| V _{imp} | Peak impulse voltage withstand with duration less than 10 ms | TBU-CX025-VTC-WH | 250 | V |
| | | TBU-CX040-VTC-WH | 400 | |
| | | TBU-CX050-VTC-WH | 500 | |
| | | TBU-CX065-VTC-WH | 650 | |
| | | TBU-CX085-VTC-WH | 850 | |
| V _{rms} | Continuous A.C. RMS voltage | TBU-CX025-VTC-WH | 100 | V |
| | | TBU-CX040-VTC-WH | 200 | |
| | | TBU-CX050-VTC-WH | 250 | |
| | | TBU-CX065-VTC-WH | 300 | |
| | | TBU-CX085-VTC-WH | 425 | |
| T _{op} | Operating temperature range | | -40 to +125 | °C |
| T _{stg} | Storage temperature range | | -65 to +150 | °C |
| T _{jmax} | Maximum Junction Temperature | | +125 | °C |
| ESD | HBM ESD Protection per IEC 61000-4-2 | | ±2 | kV |

Electrical Characteristics (@ T_A = 25 °C Unless Otherwise Noted)

| Symbol | Parameter | Part Number | Min. | Typ. | Max. | Unit |
|----------------------|---|---|------------------|------|------|------|
| I _{trigger} | Current required for the device to go from operating state to protected state (R _{external} = 0 ohm) | TBU-CXxxx-VTC-WH | 500 | 750 | 1000 | mA |
| R _{device} | Series resistance of the TBU device (R _{external} = 0 ohm) | V _{imp} = 250 V I _{trigger} (min.) = 500 mA | TBU-CX025-VTC-WH | 2.6 | 3.0 | Ω |
| | | V _{imp} = 400 V I _{trigger} (min.) = 500 mA | TBU-CX040-VTC-WH | 3.6 | 4.2 | |
| | | V _{imp} = 500 V I _{trigger} (min.) = 500 mA | TBU-CX050-VTC-WH | 5.0 | 5.7 | |
| | | V _{imp} = 650 V I _{trigger} (min.) = 500 mA | TBU-CX065-VTC-WH | 7.0 | 8.0 | |
| | | V _{imp} = 850 V I _{trigger} (min.) = 500 mA | TBU-CX085-VTC-WH | 10.7 | 13.0 | |
| t _{block} | Time for the device to go from normal operating state to protected state | | | | 1 | μs |
| I _Q | Current through the triggered TBU® device with 50 Vdc circuit voltage | | 0.25 | 0.50 | 1.00 | mA |
| V _{reset} | Voltage below which the triggered TBU® device will transition to normal operating state | | 12 | 16 | 20 | V |
| R _{th(j-l)} | Junction to package pads - FR4 using recommended pad layout | | | 98 | | °C/W |
| R _{th(j-l)} | Junction to package pads - FR4 using heat sink on board (6 cm ²) (1 in ²) | | | 40 | | °C/W |

*RoHS Directive 2002/95/EC Jan. 27, 2003 including annex and RoHS Recast 2011/65/EU June 8, 2011.

Specifications are subject to change without notice.

The device characteristics and parameters in this data sheet can and do vary in different applications and actual device performance may vary over time. Users should verify actual device performance in their specific applications.

Applications

- Voice / VDSL cards
- Protection modules and dongles
- Process control equipment
- Test and measurement equipment
- General electronics

TBU-CX Series - TBU® High-Speed Protectors

BOURNS®

Reference Application

The TBU® devices are general use protectors used in a wide variety of applications. The maximum voltage rating of the TBU device should never be exceeded. Where necessary, an OVP should be employed to limit the maximum voltage. A cost-effective protection solution combines Bourns® TBU® protection devices with a pair of Bourns® MOVs. For bandwidth sensitive applications, a Bourns® GDT may be substituted for the MOV. See “Trigger Current vs External Resistor Value” graph for selecting the optimum trigger current value using a 0 ohm – 50 ohm resistor value.

Note: Line Resistance =
TBU® Device Resistance + R_{external} Resistance

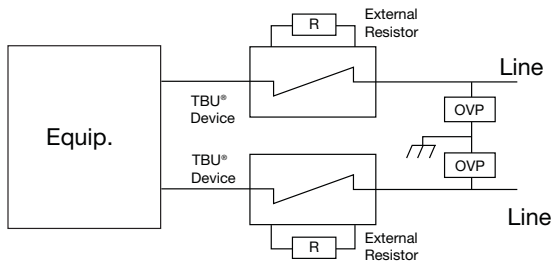

Basic TBU Operation

The TBU® device, constructed using MOSFET semiconductor technology, placed in the system circuit will monitor the current with the MOSFET detection circuit triggering to provide an effective barrier behind which sensitive electronics are not exposed to large voltages or currents during surge events. The TBU® device operates in approximately 1 μs - once line current exceeds the TBU® device's trigger current I_{trigger}. When operated, the TBU® device restricts line current to less than 1 mA typically. When operated, the TBU® device will block all voltages including the surge up to rated limits.

After the surge, the TBU® device resets when the voltage across the TBU® device falls to the V_{reset} level. The TBU® device will automatically reset on lines which have no DC bias or have DC bias below V_{reset} (such as unpowered signal lines).

If the line has a normal DC bias above V_{reset}, the voltage across the TBU® device may not fall below V_{reset} after the surge. In such cases, special care needs to be taken to ensure that the TBU® device will reset, with software monitoring as one method used to accomplish this. Bourns application engineers can provide further assistance.

Performance Graphs

Typical V-I Characteristics (TBU-CX050-VTC-WH with R_{ext} = 1 Ω)

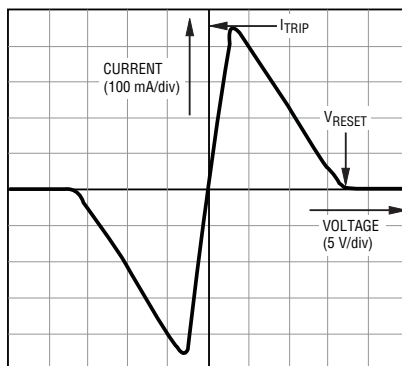

Typical Trigger Current vs. Temperature

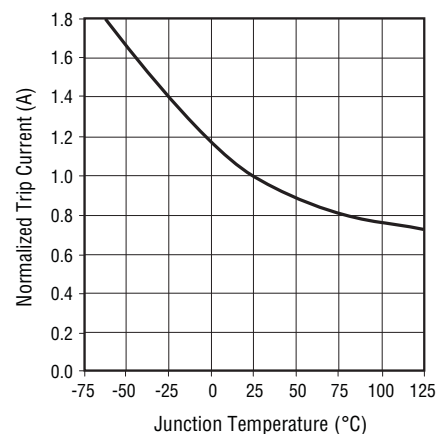

TBU-CX Series - TBU® High-Speed Protectors

BOURNS®

Performance Graphs (Continued)

Power Derating Curve

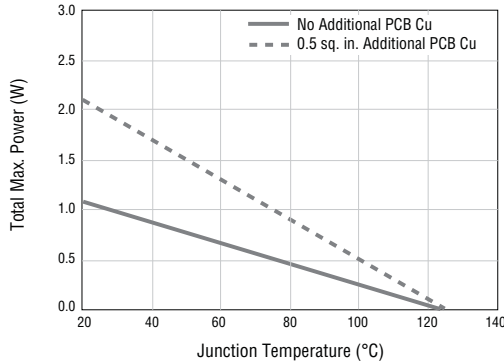

Trigger Current vs. External Resistor Value

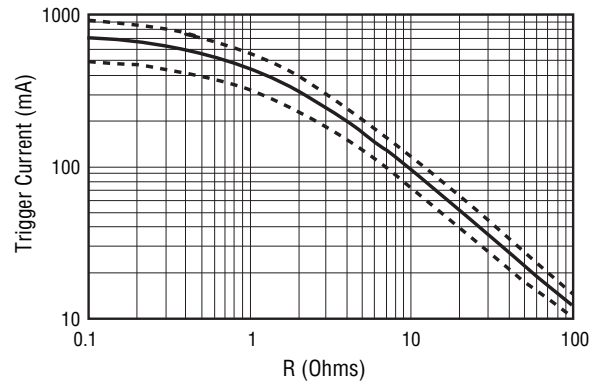

Typical Resistance vs. Temperature

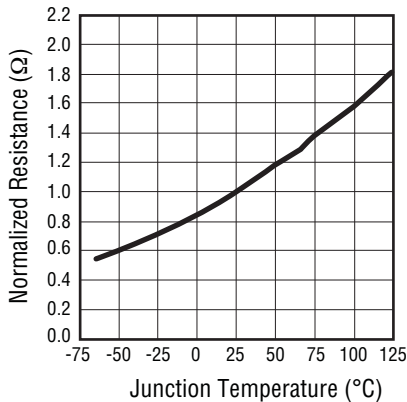

Product Dimensions

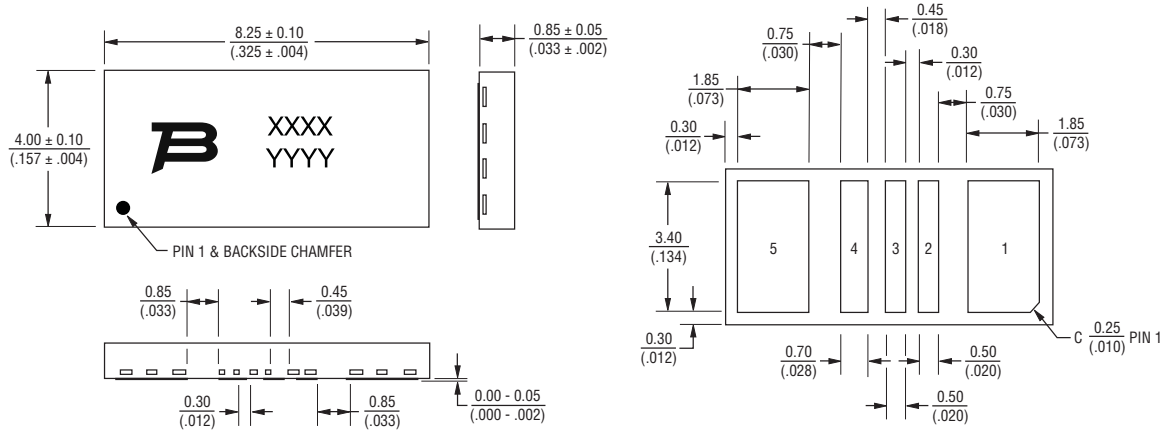

DIMENSIONS: $\frac{\text{MM}}{\text{(INCHES)}}$

Pad Designation

| Pad # | Pin Out |
|-------|----------------|
| 1 | Line In/Out |
| 2 | External R Pad |
| 3 | External R Pad |
| 4 | NU |
| 5 | Line Out/In |

Specifications are subject to change without notice. The device characteristics and parameters in this data sheet can and do vary in different applications and actual device performance may vary over time. Users should verify actual device performance in their specific applications.

Recommended Pad Layout

TBU® High-Speed Protectors have a 100 % matte-tin termination finish. For improved thermal dissipation, the recommended layout uses PCB copper areas which extend beyond the exposed solder pad. The exposed solder pads should be defined by a solder mask which matches the pad layout of the TBU® device in size and spacing. It is recommended that they should be the same dimension as the TBU® pads but if smaller solder pads are used, they should be centered on the TBU® package terminal pads and not more than 0.10-0.12 mm (0.004-0.005 in.) smaller in overall width or length. Solder pad areas should not be larger than the TBU® pad sizes to ensure adequate clearance is maintained. The recommended stencil thickness is 0.10-0.12 mm (0.004-0.005 in.) with a stencil opening size 0.025 mm (0.0010 in.) less than the solder pad size. Extended copper areas beyond the solder pad significantly improve the junction to ambient thermal resistance, resulting in operation at lower junction temperatures with a corresponding benefit of reliability. All pads should soldered to the PCB, including pads marked as NC or NU but no electrical connection should be made to these pads. For minimum parasitic capacitance, it is recommended that signal, ground or power signals are not routed beneath any pad.

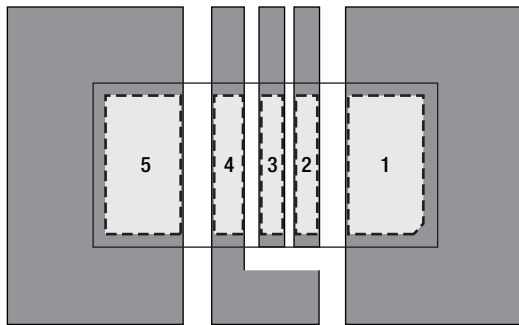

Dark grey areas show added PCB copper area for better thermal resistance.

Reflow Profile

| Profile Feature | Pb-Free Assembly |
|---|------------------|
| Average Ramp-Up Rate (T _{smax} to T _p) | 3 °C/sec. max. |
| Preheat | |
| - Temperature Min. (T _{smin}) | 150 °C |
| - Temperature Max. (T _{smax}) | 200 °C |
| - Time (t _{smin} to t _{smax}) | 60-180 sec. |
| Time maintained above: | |
| - Temperature (T _L) | 217 °C |
| - Time (t _L) | 60-150 sec. |
| Peak/Classification Temperature (T _p) | 260 °C |
| Time within 5 °C of Actual Peak Temp. (t _p) | 20-40 sec. |
| Ramp-Down Rate | 6 °C/sec. max. |
| Time 25 °C to Peak Temperature | 8 min. max. |

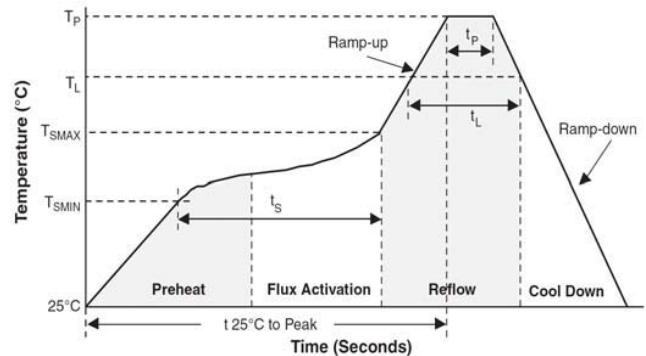

Thermal Resistance vs Additional PCB Cu Area

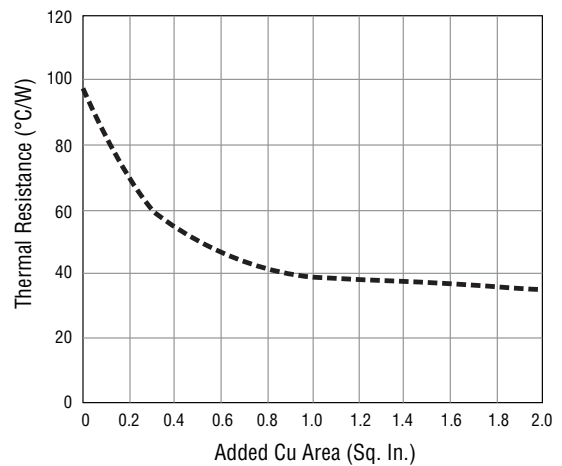

TBU-CX Series - TBU® High-Speed Protectors

BOURNS®

How to Order

TBU - CX 085 - VTC - WH

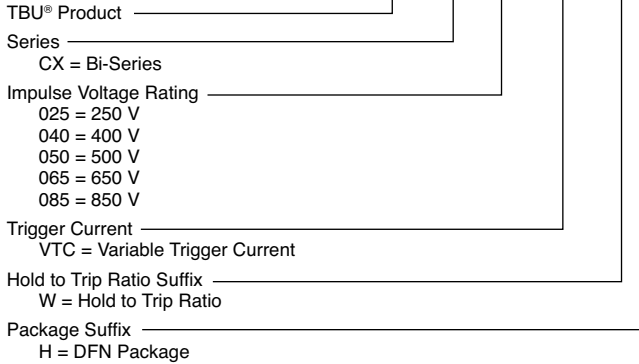

Typical Part Marking

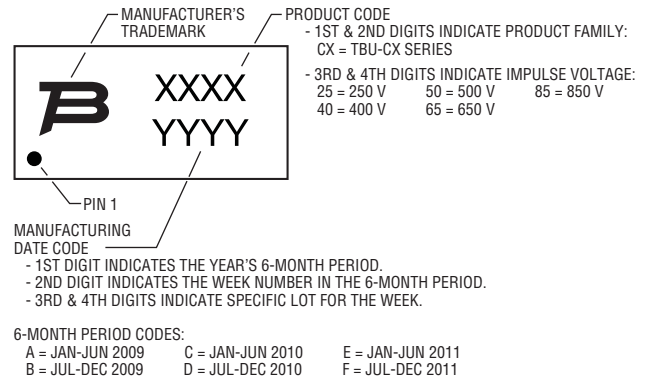

Packaging Specifications

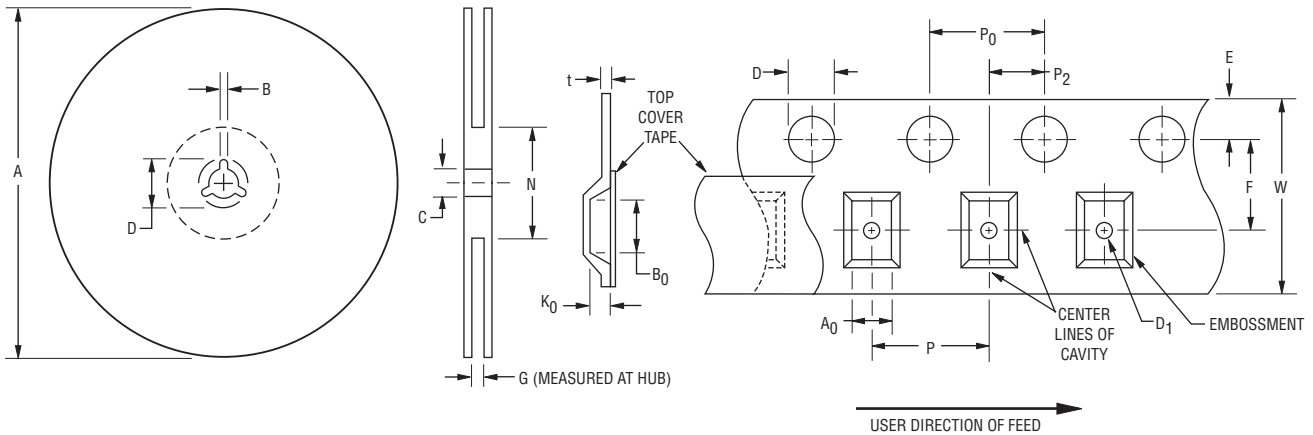

QUANTITY: 3000 PIECES PER REEL

| A | | B | | C | | D | | G | N |
|----------|----------|--------|--------|--------|--------|--------|------|--------|---------|
| Min. | Max. | Min. | Max. | Min. | Max. | Min. | Max. | Ref. | Ref. |
| 326 | 330 | 1.5 | 2.5 | 12.8 | 13.5 | 20.2 | - | 16.5 | 102 |
| (12.835) | (13.002) | (.059) | (.098) | (.504) | (.531) | (.795) | | (.650) | (4.016) |

| A0 | | B0 | | D | | D1 | | E | | F | |
|--------|--------|--------|--------|--------|--------|--------|--------|--------|--------|--------|--------|
| Min. | Max. | Min. | Max. | Min. | Max. | Min. | Max. | Min. | Max. | Min. | Max. |
| 4.3 | 4.5 | 8.45 | 8.65 | 1.5 | 1.6 | 1.5 | - | 1.65 | 1.85 | 7.4 | 7.6 |
| (.169) | (.177) | (.333) | (.341) | (.059) | (.063) | (.059) | | (.065) | (.073) | (.291) | (.299) |
| K0 | | P | | P0 | | P2 | | t | | W | |
| Min. | Max. | Min. | Max. | Min. | Max. | Min. | Max. | Min. | Max. | Min. | Max. |
| 1.0 | 1.2 | 7.9 | 8.1 | 3.9 | 4.1 | 1.9 | 2.1 | 0.25 | 0.35 | 15.7 | 16.3 |
| (.039) | (.047) | (.311) | (.319) | (.159) | (.161) | (.075) | (.083) | (.010) | (.014) | (.618) | (.642) |

DIMENSIONS: $\frac{\text{MM}}{\text{(INCHES)}}$

REV. 07/14

"TBU" is a registered trademark of Bourns, Inc. in the United States and other countries.

Specifications are subject to change without notice.

The device characteristics and parameters in this data sheet can and do vary in different applications and actual device performance may vary over time.

Users should verify actual device performance in their specific applications.

Looking for pricing, stock, or lifecycle information?

Click below to explore more details on WIN SOURCE:

- [View TBU-CX085-VTC-WH on WIN SOURCE](#)
- [Bourns Inc. Information](#)

Optimize Your Supply Chain with WIN SOURCE Solutions

- ✓ Global Sourcing Solution
- ✓ Obsolete Management
- ✓ Cost Control Management
- ✓ Shortage Management
- ✓ Alternative Solution
- ✓ Excess Inventory Management