



**THE DATASHEET OF  
PQ070XF01SZH**



# PQ070XF01SZH

TO-220 Type, Low Voltage Operation  
Low Power-Loss Voltage Regulators

## ■ Features

1. Low voltage operation  
(Minimum operating voltage: 2.35V)
2. Low dissipation current  
(Dissipation current at no load: MAX. 2mA)
3. Low power-loss  
Dropout voltage: MAX.0.5V at  $I_O=0.5A$
4. Built-in overcurrent and overheat protection functions
5. RoHS directive compliant

## ■ Applications

1. Power supplies for personal computers and peripheral equipment
2. Power supplies for various electronic equipment such as DVD player or STB
3. LBP

## ■ Absolute Maximum Ratings

( $T_a=25^{\circ}C$ )

Parameter	Symbol	Rating	Unit
*1 Input voltage	$V_{IN}$	10	V
*1 Output adjustment terminal voltage	$V_{ADJ}$	5	V
Output current	$I_O$	1.0	A
*2 Power dissipation	$P_{D1}$	1.4	W
	$P_{D2}$	15	
*3 Junction temperature	$T_j$	150	$^{\circ}C$
Operating temperature	$T_{opr}$	-40 to +85	$^{\circ}C$
Storage temperature	$T_{stg}$	-40 to +150	$^{\circ}C$
Soldering temperature	$T_{sol}$	260(10s)	$^{\circ}C$

\*1 All are open except GND and applicable terminals.  
 \*2  $P_{D1}$ : No heat sink,  $P_{D2}$ : With infinite heat sink.  
 \*3 Overheat protection may operate at  $T_j=125^{\circ}C$  to  $150^{\circ}C$

## ■ Outline Dimensions

(Unit : mm)

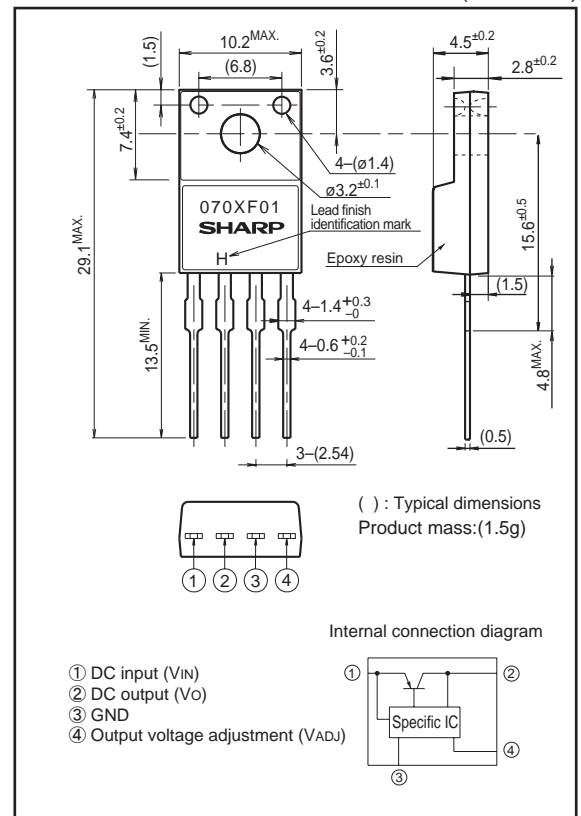

( ) : Typical dimensions  
Product mass:(1.5g)

Internal connection diagram

- ① DC input ( $V_{IN}$ )
- ② DC output ( $V_O$ )
- ③ GND
- ④ Output voltage adjustment ( $V_{ADJ}$ )

Lead finish: Lead-free solder plating  
(Composition: Sn2Cu)

Notice The content of data sheet is subject to change without prior notice.

In the absence of confirmation by device specification sheets, SHARP takes no responsibility for any defects that may occur in equipment using any SHARP devices shown in catalogs, data books, etc. Contact SHARP in order to obtain the latest device specification sheets before using any SHARP device.

## Electrical Characteristics

(Unless otherwise specified, condition shall be  $V_{IN}=5V, V_O=3V(R_1=1k\Omega), I_O=0.5A, T_a=25^\circ C$ )

Parameter	Symbol	Conditions	MIN.	TYP.	MAX.	Unit
Input voltage	$V_{IN}$	-	2.35	-	10	V
Output voltage	$V_O$	-	1.5	-	7	V
Reference voltage	$V_{REF}$	-	1.225	1.25	1.275	V
Load regulation	$R_{egL}$	$I_O=5mA$ to 1A	-	0.2	2.0	%
Line regulation	$R_{egI}$	$V_{IN}=4$ to 8V, $I_O=5mA$	-	0.2	1.0	%
Temperature coefficient of reference voltage	$TcV_{REF}$	$T_j=0$ to $+125^\circ C$ , $I_O=5mA$	-	$\pm 1.0$	-	%
Ripple rejection	RR	Refer to Fig.2	45	60	-	dB
Dropout voltage	$V_{I-O}$	$V_{IN}=2.85V, I_O=0.5A$	-	-	0.5	V
Quiescent current	$I_q$	$I_O=0A$	-	1.3	2	mA

Fig.1 Test Circuit

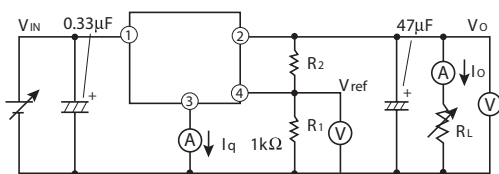

$$V_O = V_{ref} \times \left( 1 + \frac{R_2}{R_1} \right)$$

[ $R_1=1k\Omega, V_{ref}$  Nearly= $1.25V$ ]

Fig.2 Test Circuit of Ripple Rejection

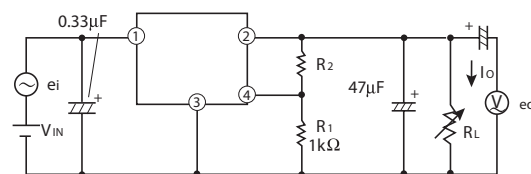

$f=120Hz$ (sine wave)  
 $e_i(rms) = 0.5V$   
 $I_O=0.5A$   
 $RR=20 \log(e_i(rms) / e_o(rms))$   
 $V_{IN}=5V$   
 $V_O=3.0V(R_1=1k\Omega)$

Fig.3 Power Dissipation vs. Ambient Temperature

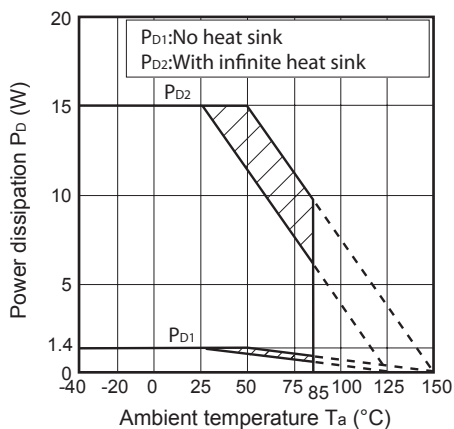

Note) Oblique line portion: Overheat protection may operate in this area.

Fig.4 Overcurrent Protection Characteristics (Typical Value)

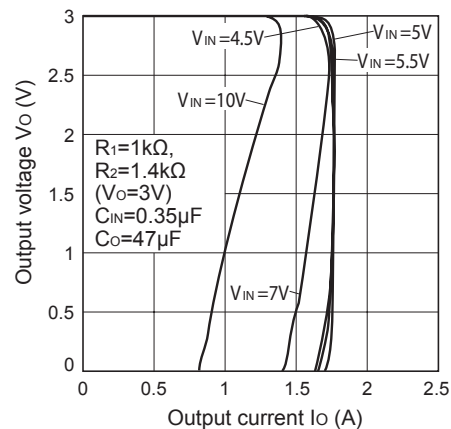

Fig.5 Reference Voltage vs. Junction Temperature

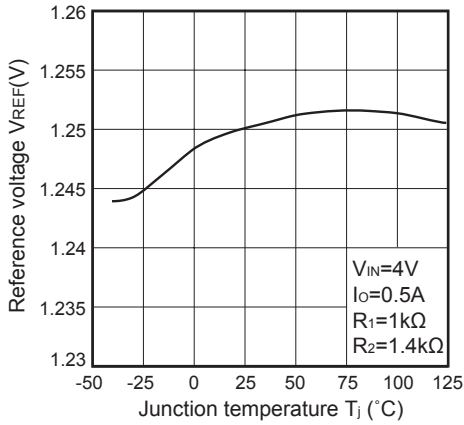

Fig.6 Output Voltage vs. Input Voltage

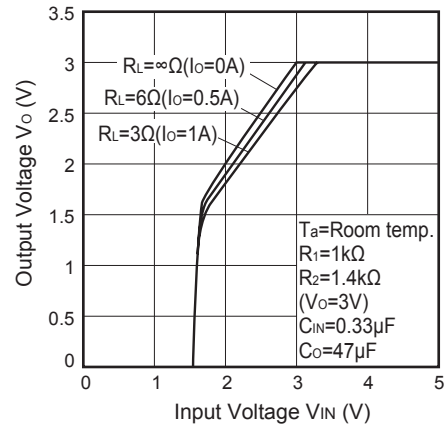

Fig.7 Circuit Operating Current vs. Input Voltage

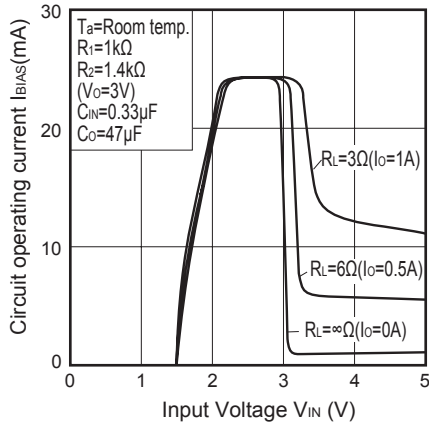

Fig.8 Dropout Voltage vs. Junction Temperature

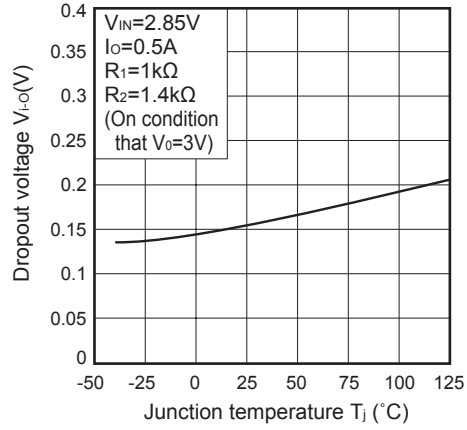

Fig.9 Quiescent Current vs. Junction Temperature

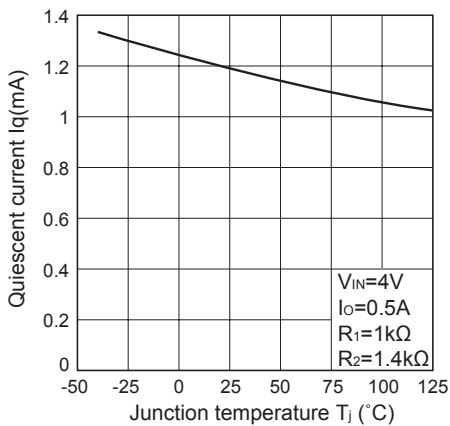

Fig.10 Ripple Rejection vs. Input Ripple Frequency

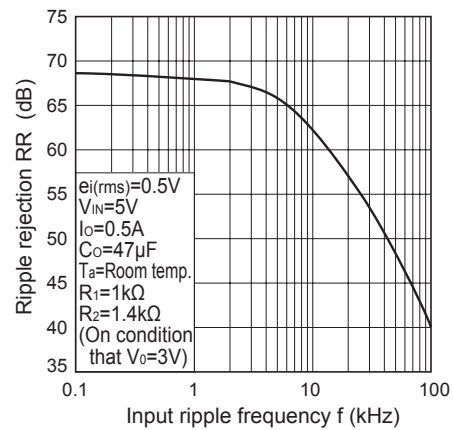

Fig.11 Ripple Rejection vs. Output Current

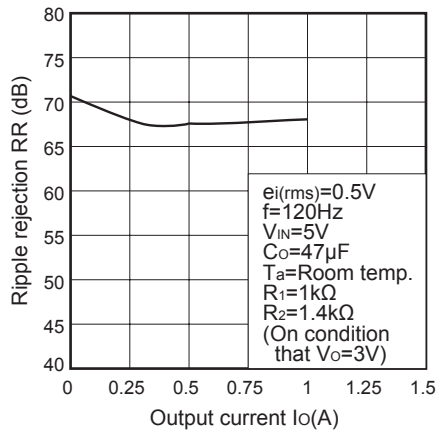
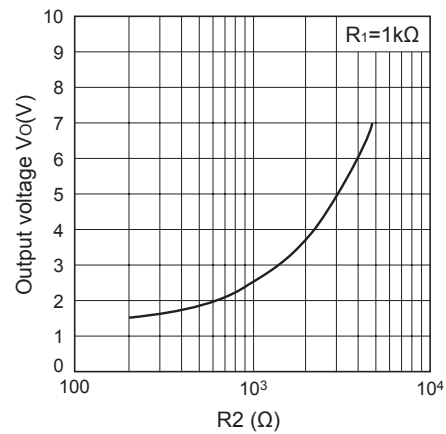
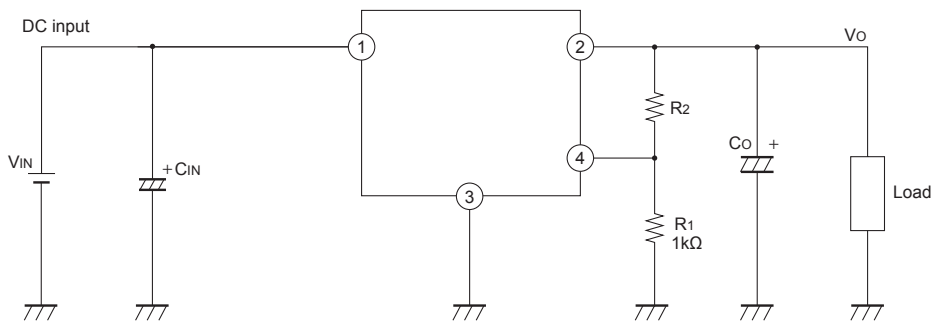

Fig.12 Output Voltage Adjustment Characteristics (Typical value)



### ■ Typical Application



### ■ Setting of Output Voltage

Output voltage is able to set from 1.5V to 7V when resistors R<sub>1</sub> and R<sub>2</sub> are attached to ,②、③、④ terminals. As for the external resistors to set output voltage, refer to the figure below and Fig.12.

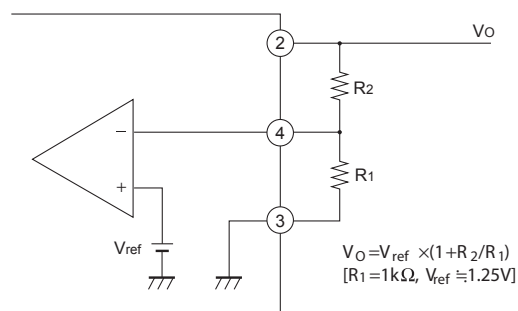

## Looking for pricing, stock, or lifecycle information?

Click below to explore more details on WIN SOURCE:

-  [View PQ070XF01SZH on WIN SOURCE](#)
-  [Sharp Microelectronics](#) Information

## Optimize Your Supply Chain with WIN SOURCE Solutions

-  Global Sourcing Solution
-  Obsolete Management
-  Cost Control Management
-  Shortage Management
-  Alternative Solution
-  Excess Inventory Management