



ON Semiconductor®

www.onsemi.com

MCH6337

Power MOSFET –20V, 49mΩ, –4.5A, Single P-Channel

Features

- Low On-Resistance
- Low Gate Drive Voltage
- Pb-Free and RoHS Compliance
- Halogen Free Compliance : MCH6337-TL-H, MCH6337-TL-W
- High Speed Switching
- ESD Diode-Protected Gate

Specifications

Absolute Maximum Ratings at Ta = 25°C

Parameter	Symbol	Value	Unit
Drain to Source Voltage	V _{DSS}	–20	V
Gate to Source Voltage	V _{GSS}	±10	V
Drain Current (DC)	I _D	–4.5	A
Drain Current (Pulse) PW≤10μs, duty cycle≤1%	I _{DP}	–18	A
Power Dissipation When mounted on ceramic substrate (1200mm ² ×0.8mm)	P _D	1.5	W
Junction Temperature	T _J	150	°C
Storage Temperature	T _{stg}	–55 to +150	°C

Thermal Resistance Ratings

Parameter	Symbol	Value	Unit
Junction to Ambient When mounted on ceramic substrate (1200mm ² ×0.8mm)	R _{θJA}	83.3	°C/W

Stresses exceeding those listed in the Maximum Ratings table may damage the device. If any of these limits are exceeded, device functionality should not be assumed, damage may occur and reliability may be affected.

Electrical Connection P-Channel

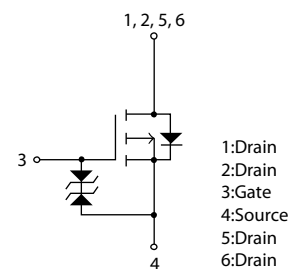

Packing Type:TL

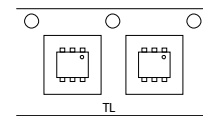

Marking

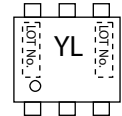

ORDERING INFORMATION

See detailed ordering and shipping information on page 5 of this data sheet.

MCH6337

Electrical Characteristics at $T_a = 25^\circ\text{C}$

Parameter	Symbol	Conditions	Value			Unit
			min	typ	max	
Drain to Source Breakdown Voltage	$V_{(BR)DSS}$	$I_D = -1\text{mA}$, $V_{GS} = 0\text{V}$	-20			V
Zero-Gate Voltage Drain Current	I_{DSS}	$V_{DS} = -20\text{V}$, $V_{GS} = 0\text{V}$			-1	μA
Gate to Source Leakage Current	I_{GSS}	$V_{GS} = \pm 8\text{V}$, $V_{DS} = 0\text{V}$			± 10	μA
Gate Threshold Voltage	$V_{GS(th)}$	$V_{DS} = -10\text{V}$, $I_D = -1\text{mA}$	-0.4		-1.3	V
Forward Transconductance	g_{FS}	$V_{DS} = -10\text{V}$, $I_D = -3\text{A}$	3.5	5.9		S
Static Drain to Source On-State Resistance	$R_{DS(on)1}$	$I_D = -3\text{A}$, $V_{GS} = -4.5\text{V}$		37	49	$\text{m}\Omega$
	$R_{DS(on)2}$	$I_D = -1.5\text{A}$, $V_{GS} = -2.5\text{V}$		53	75	$\text{m}\Omega$
	$R_{DS(on)3}$	$I_D = -0.5\text{A}$, $V_{GS} = -1.8\text{V}$		85	130	$\text{m}\Omega$
Input Capacitance	C_{iss}	$V_{DS} = -10\text{V}$, $f = 1\text{MHz}$		670		pF
Output Capacitance	C_{oss}			130		pF
Reverse Transfer Capacitance	C_{rss}			94		pF
Turn-ON Delay Time	$t_{d(on)}$			8.4		ns
Rise Time	t_r	See specified Test Circuit		45		ns
Turn-OFF Delay Time	$t_{d(off)}$			69		ns
Fall Time	t_f			63		ns
Total Gate Charge	Q_g	$V_{DS} = -10\text{V}$, $V_{GS} = -4.5\text{V}$, $I_D = -4.5\text{A}$		7.3		nC
Gate to Source Charge	Q_{gs}			1.3		nC
Gate to Drain "Miller" Charge	Q_{gd}			2.1		nC
Forward Diode Voltage	V_{SD}		$I_S = -4.5\text{A}$, $V_{GS} = 0\text{V}$		-0.82	-1.2

Product parametric performance is indicated in the Electrical Characteristics for the listed test conditions, unless otherwise noted. Product performance may not be indicated by the Electrical Characteristics if operated under different conditions.

Switching Time Test Circuit

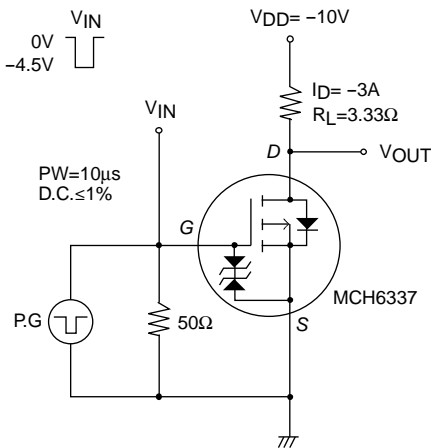

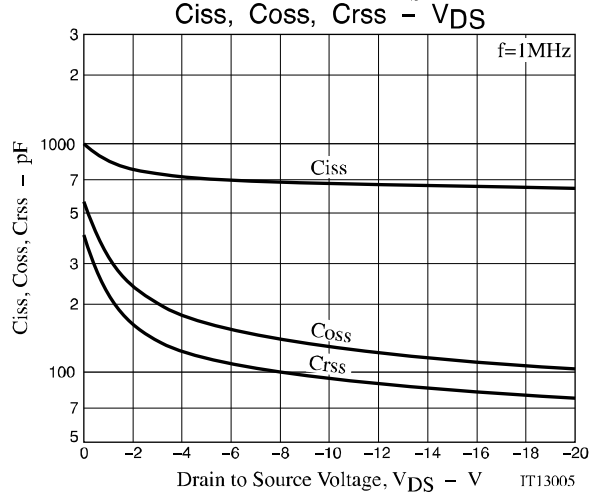
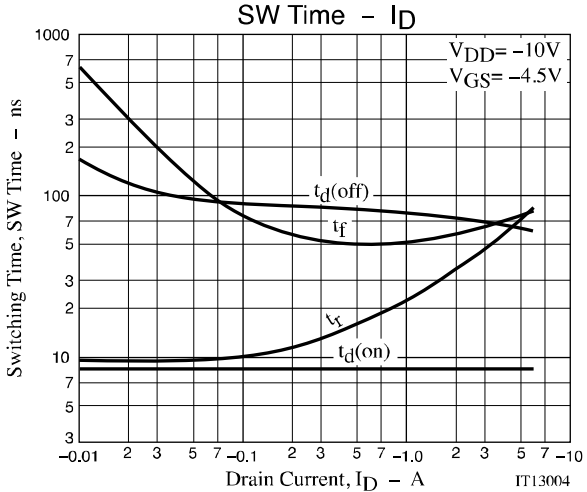
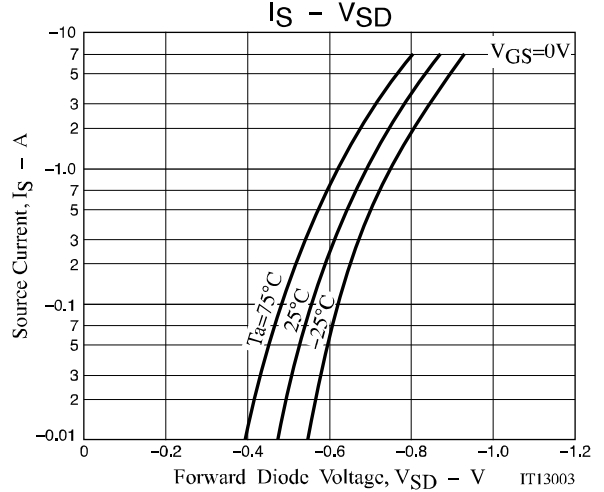
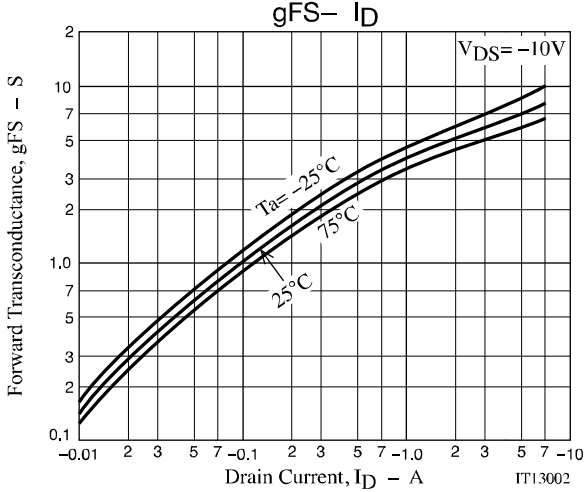
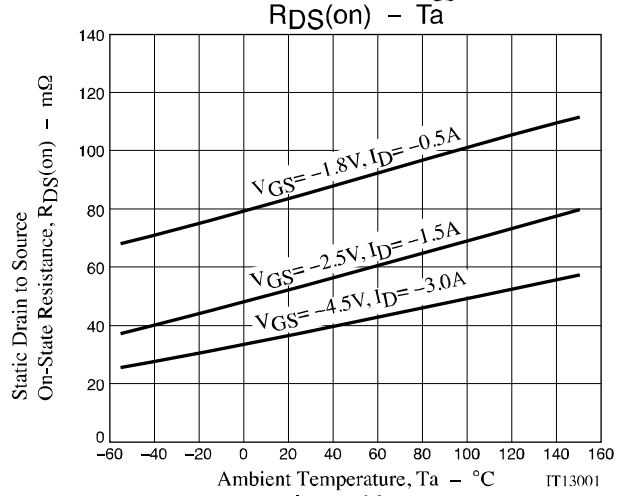
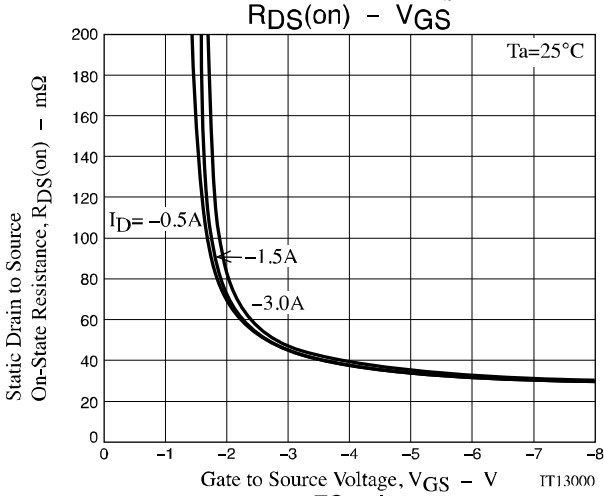
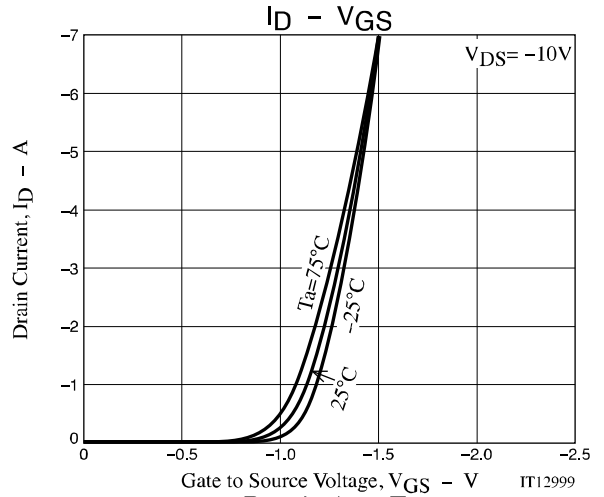
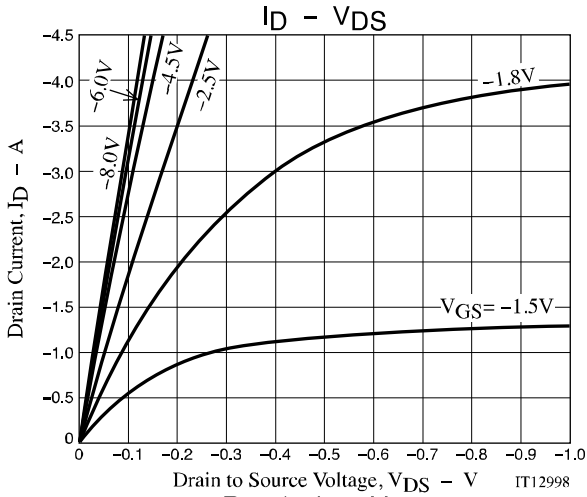

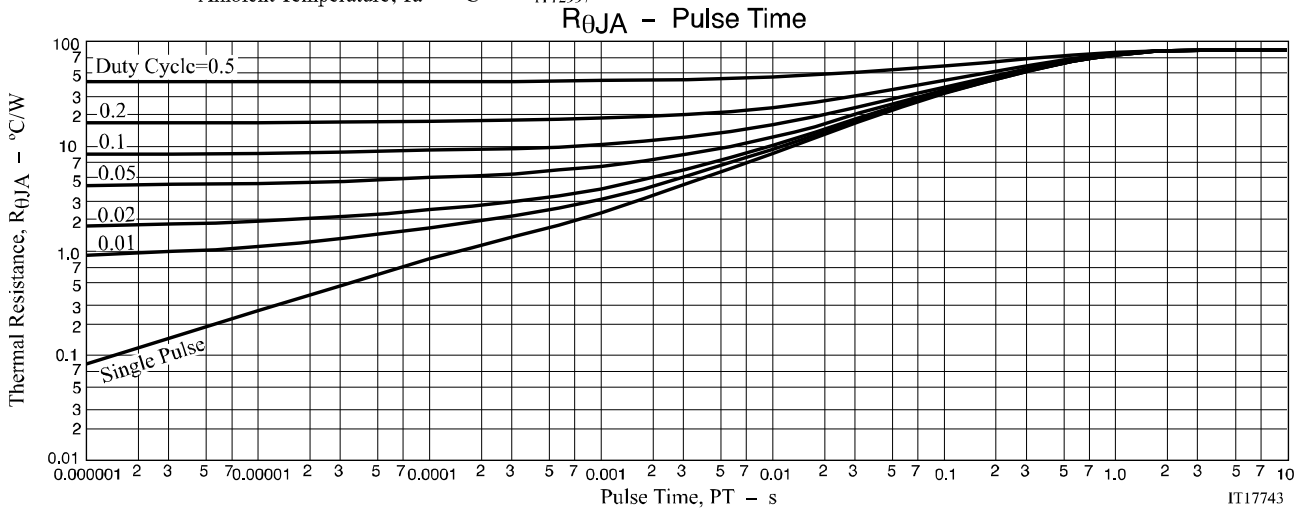
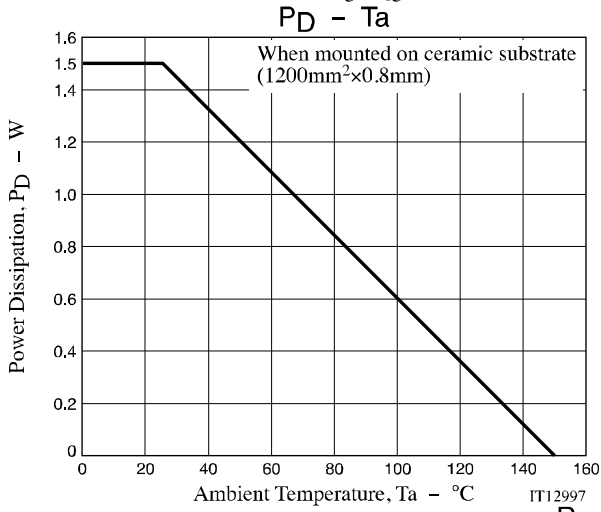
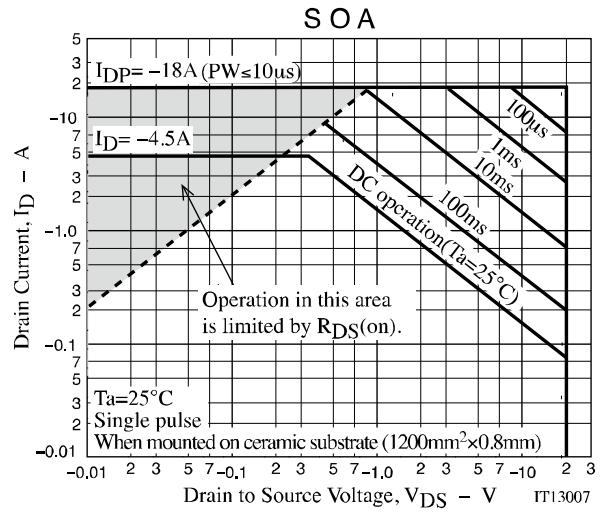
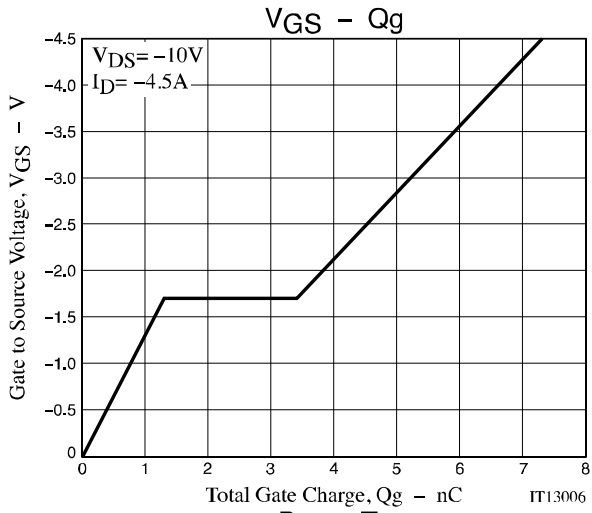

Looking for pricing, stock, or lifecycle information?

Click below to explore more details on WIN SOURCE:

- ⊖ [View MCH6337-TL-H on WIN SOURCE](#)
- ⊖ [ON Semiconductor](#) Information

Optimize Your Supply Chain with WIN SOURCE Solutions

- ✓ Global Sourcing Solution
- ✓ Obsolete Management
- ✓ Cost Control Management
- ✓ Shortage Management
- ✓ Alternative Solution
- ✓ Excess Inventory Management