



**THE DATASHEET OF
EL7515IY-T7**



**NOT RECOMMENDED FOR NEW DESIGNS
NO RECOMMENDED REPLACEMENT
contact our Technical Support Center at
1-888-INTERSIL or www.intersil.com/tsc**

EL7515

High Frequency PWM Step-Up Regulator

FN7120
Rev 2.00
August 10, 2007

The EL7515 is a high frequency, high efficiency step-up DC/DC regulator operated at fixed frequency PWM mode. With an integrated 1.4A MOSFET, it can deliver up to 600mA output current at up to 92% efficiency. The adjustable switching frequency is up to 1.2MHz, making it ideal for DSL applications.

When shut down, it draws <math><1\mu\text{A}</math> of current. This feature, along with the minimum starting voltage of 1.8V, makes it suitable for portable equipment powered by one Lithium Ion, 3 to 4 NiMH cells, or 2 cells of alkaline battery.

The EL7515 is available in a 10 Ld MSOP package, with maximum height of 1.1mm. With proper external components, the whole converter takes less than 0.25in² PCB space.

This device is specified for operation over the full -40°C to +85°C temperature range.

Pinout

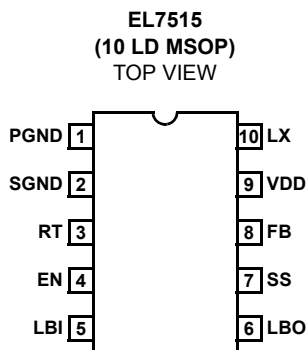

Features

- Up to 92% efficiency
- Up to 600mA I_{OUT}
- 4.5V < V_{OUT} < 17V
- 1.8V < V_{IN} < 13.2V
- Up to 1.2MHz adjustable frequency
- <math><1\mu\text{A}</math> shutdown current
- Adjustable soft-start
- Low battery detection
- Internal thermal protection
- 1.1mm max height 10 Ld MSOP package
- Pb-Free available (RoHS compliant)

Applications

- 3V to 5V and 12V converters
- 5V to 12V converters
- TFT-LCD
- DSL
- Portable equipment
- Desktop equipment

Ordering Information

PART NUMBER	PART MARKING	PACKAGE	PKG. DWG. #
EL7515IY	e	10 Ld MSOP	MDP0043
EL7515IY-T7*	e	10 Ld MSOP	MDP0043
EL7515IY-T13*	e	10 Ld MSOP	MDP0043
EL7515IYZ (Note)	BAAAR	10 Ld MSOP (Pb-free)	MDP0043
EL7515IYZ-T7* (Note)	BAAAR	10 Ld MSOP (Pb-free)	MDP0043
EL7515IYZ-T13* (Note)	BAAAR	10 Ld MSOP (Pb-free)	MDP0043

*Please refer to TB347 for details on reel specifications.

NOTE: These Intersil Pb-free plastic packaged products employ special Pb-free material sets; molding compounds/die attach materials and 100% matte tin plate PLUS ANNEAL - e3 termination finish, which is RoHS compliant and compatible with both SnPb and Pb-free soldering operations. Intersil Pb-free products are MSL classified at Pb-free peak reflow temperatures that meet or exceed the Pb-free requirements of IPC/JEDEC J STD-020.

Typical Application

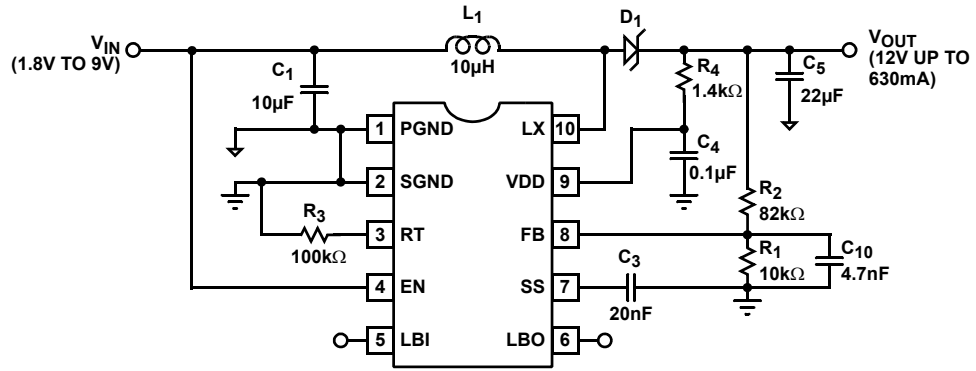

Absolute Maximum Ratings ($T_A = +25^\circ\text{C}$)

EN, LBI, V_{DD}	+12V
LX	+18V

Thermal Information

Storage Temperature	-65°C to +150°C
Operating Temperature	-40°C to +85°C
Operating Junction Temperature:	+135°C
Pb-free reflow profile	see link below
	http://www.intersil.com/pbfree/Pb-FreeReflow.asp

CAUTION: Do not operate at or near the maximum ratings listed for extended periods of time. Exposure to such conditions may adversely impact product reliability and result in failures not covered by warranty.

IMPORTANT NOTE: All parameters having Min/Max specifications are guaranteed. Typ values are for information purposes only. Unless otherwise noted, all tests are at the specified temperature and are pulsed tests, therefore: $T_J = T_C = T_A$

Electrical Specifications $V_{IN} = 5\text{V}$, $V_{OUT} = 12\text{V}$, $L = 10\mu\text{H}$, $I_{OUT} = 0\text{mA}$, $R_T = 100\text{k}\Omega$, $T_A = +25^\circ\text{C}$, Unless Otherwise Specified.

PARAMETER	DESCRIPTION	CONDITIONS	MIN (Note 1)	TYP	MAX (Note 1)	UNIT
V_{IN}	Input Voltage Range		1.8		13.2	V
V_{OUT}	Output Voltage Range		4.5		17	V
IQ1	Quiescent Current - Shut-down	$V_{EN} = 0$, feedback resistors disconnected			1	μA
IQ2	Quiescent Current	$V_{EN} = 2\text{V}$		1.4	2	mA
V_{FB}	Feedback Voltage		1.29	1.33	1.37	V
IB	Feedback Input Bias Current				0.10	μA
D_{MAX}	Maximum Duty Cycle		84	90		%
I_{LIM}	Current Limit - Max Peak Input Current		1	1.4		A
I_{SHDN}	Shut-down Input Bias Current				1	μA
V_{LBI}	LBI Threshold Voltage		180	220	250	mV
V_{OL-LBO}	LBO Output Low	$I_{LBO} = 1\text{mA}$		0.1	0.2	V
$I_{LEAK-LBO}$	LBO Output Leakage Current	$V_{LBI} = 250\text{mV}$, $V_{LBO} = 5\text{V}$		0.02	2	μA
$r_{DS(ON)}$	Switch On Resistance	at 12V output		220		$\text{m}\Omega$
$I_{LEAK-SWITCH}$	Switch Leakage Current				1	μA
$\Delta V_{OUT}/\Delta V_{IN}/V_{OUT}$	Line Regulation	$3\text{V} < V_{IN} < 6\text{V}$, $V_{OUT} = 12\text{V}$, no load		0.4		%/V
$\Delta V_{OUT}/V_{OUT}$	Load Regulation	$I_{OUT} = 50\text{mA}$ to 150mA		1		%
$f_{OSC-MAX}$	Maximum Switching Frequency	$R_T = 49.9\text{k}\Omega$		1200		kHz
f_{OSC1}	Switching Frequency		600	670	750	kHz
VHI_EN	EN Input High Threshold		1.6			V
VLO_EN	EN Input Low Threshold				0.5	V

Pin Descriptions

PIN NUMBER	PIN NAME	PIN FUNCTION
1	PGND	Power ground; connected to the source of internal N-Channel power MOSFET
2	SGND	Signal ground; ground reference for all the control circuitry; needs to have only a single connection to PGND
3	RT	Timing resistor to adjust the oscillation frequency of the converter
4	EN	Chip enable; connects to logic HI (>1.6V) for chip to function
5	LBI	Low battery input; connects to a sensing voltage, or left open if function is not used
6	LBO	Low battery detection output; connected to the open drain of a MOSFET; able to sink 1mA current
7	SS	Soft-start; connects to a capacitor to control the start-up of the converter
8	FB	Voltage feedback input; needs to connect to resistor divider to decide V_O
9	VDD	Control circuit positive supply
10	LX	Inductor drive pin; connected to the drain of internal N-Channel power MOSFET

Typical Performance Curves

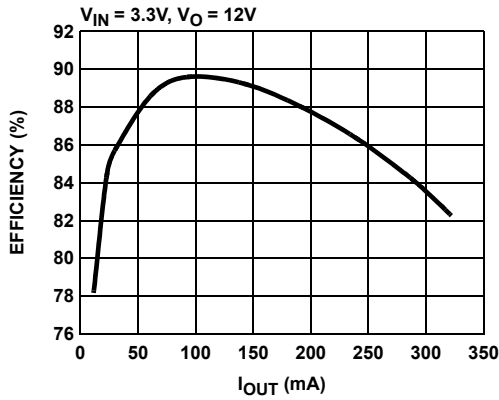

FIGURE 1. EFFICIENCY vs I_{OUT}

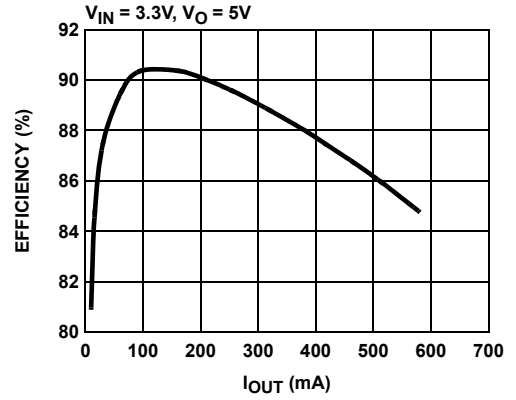

FIGURE 2. EFFICIENCY vs I_{OUT}

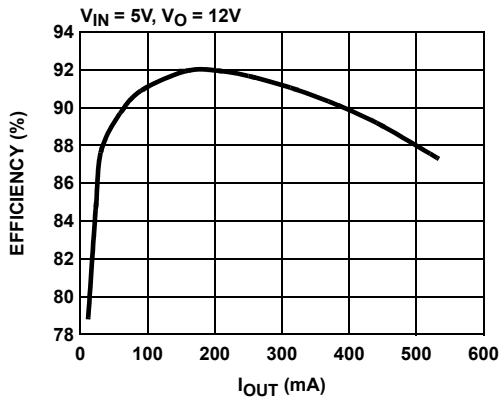

FIGURE 3. EFFICIENCY vs I_{OUT}

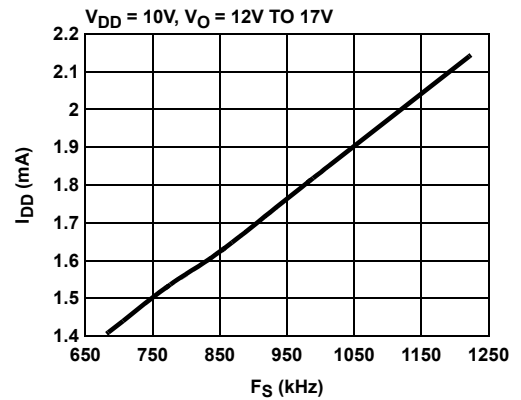

FIGURE 4. I_{DD} vs F_S

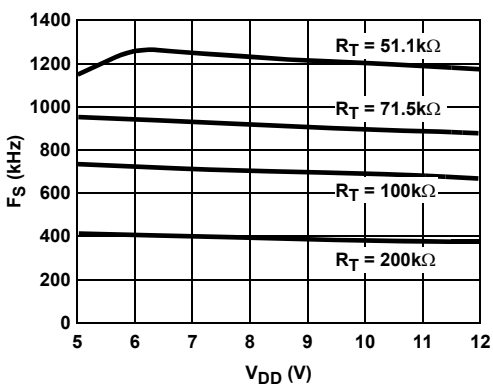

FIGURE 5. F_S vs V_{DD}

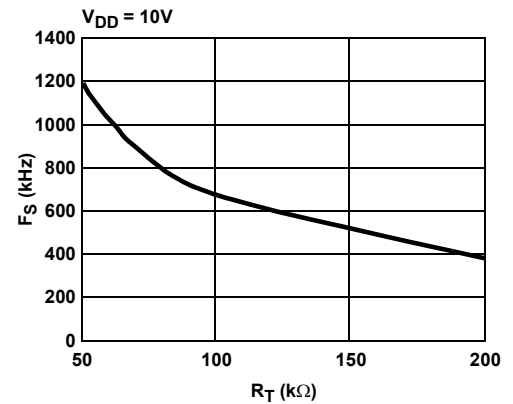

FIGURE 6. F_S vs R_T

Typical Performance Curves (Continued)

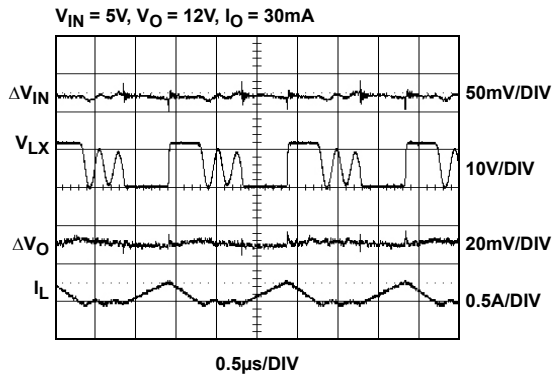

FIGURE 7. STEADY STATE OPERATION (INDUCTOR DISCONTINUOUS CONDUCTION)

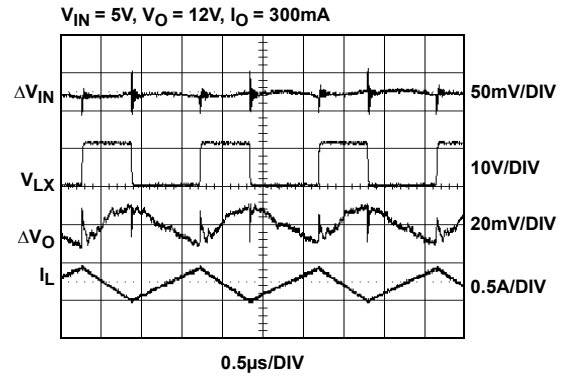

FIGURE 8. STEADY STATE OPERATION (INDUCTOR CONTINUOUS CONDUCTION)

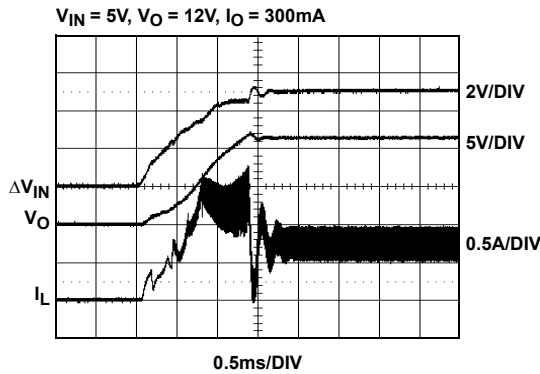

FIGURE 9. POWER-UP

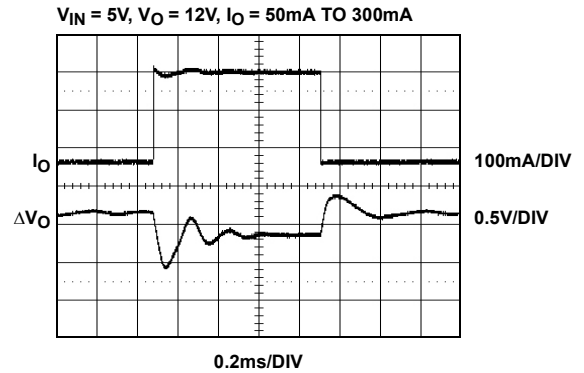

FIGURE 10. LOAD TRANSIENT RESPONSE

Applications Information

The EL7515 is a step-up regulator, operated at fixed frequency pulse-width-modulation (PWM) control. The input voltage is 1.8V to 13.2V and output voltage is 4.5V to 17V. The switching frequency (up to 1.2MHz) is decided by the resistor connected to R_T pin.

Start-Up

After V_{DD} reaches a threshold of about 1.7V, the start-up oscillator generates fixed duty-ratio of 0.5 to 0.7 at a frequency of several hundred kilohertz. This will boost the output voltage.

When V_{DD} reaches about 3.7V, the PWM comparator takes over the control. The duty ratio will be decided by the multiple-input direct summing comparator, Max_Duty signal (about 90% duty-ratio), and the Current Limit Comparator, whichever is the smallest.

The soft-start is provided by the current limit comparator. As the internal 12μA current source charges the external CSS, the peak MOSFET current is limited by the voltage on the

capacitor. This in turn controls the rising rate of the output voltage.

The regulator goes through the start-up sequence as well after the EN signal is pulled to HI.

Steady-State Operation

When the output reaches the preset voltage, the regulator operates at steady state. Depending on the input/output conditions and component values, the inductor operates at either continuous-conduction mode or discontinuous-conduction mode.

In the continuous-conduction mode, the inductor current is a triangular waveform and LX voltage a pulse waveform. In the discontinuous-conduction mode, the inductor current is completely dried out before the MOSFET is turned on again. The input voltage source, the inductor, and the MOSFET and output diode parasitic capacitors form a resonant circuit. Oscillation will occur in this period. This oscillation is normal and will not affect the regulation.

At very low load, the MOSFET will skip pulses sometimes. This is normal.

Current Limit

The MOSFET current limit is nominally 1.4A and guaranteed 1A. This restricts the maximum output current I_{OMAX} based on Equation 1:

$$I_{OMAX} = \left(1 - \frac{\Delta I_L}{2}\right) \times \frac{V_{IN}}{V_O} \tag{EQ. 1}$$

where:

- ΔI_L is the inductor peak-to-peak current ripple and is decided by Equation 2:

$$\Delta I_L = \frac{V_{IN}}{L} \times \frac{D}{f_S} \tag{EQ. 2}$$

- D is the MOSFET turn-on ratio and is decided by Equation 3:

$$D = \frac{V_O - V_{IN}}{V_O} \tag{EQ. 3}$$

- f_S is the switching frequency

The following table gives typical values:

TABLE 1. MAX CONTINUOUS OUTPUT CURRENTS

V_{IN} (V)	V_O (V)	L (MH)	F_S (kHz)	I_{OMAX} (mA)
2	5	10	1000	360
2	9	10	1000	190
2	12	10	1000	140
3.3	5	10	1000	600
3.3	9	10	1000	310
3.3	12	10	1000	230
5	9	10	1000	470
5	12	10	1000	340
9	12	10	1000	630
12	15	10	100	670

Component Considerations

It is recommended that C_{IN} is larger than 10 μ F. Theoretically, the input capacitor has a ripple current of ΔI_L . Due to high-frequency noise in the circuit, the input current ripple may exceed the theoretical value. A larger capacitor will reduce the ripple further.

The inductor has peak and average current decided by Equations 4 and 5:

$$I_{LPK} = I_{LAVG} + \frac{\Delta I_L}{2} \tag{EQ. 4}$$

$$I_{LAVG} = \frac{I_O}{1-D} \tag{EQ. 5}$$

The inductor should be chosen to be able to handle this current. Furthermore, due to the fixed internal compensation, it is recommended that maximum inductance of 10 μ H and 15 μ H to be used in the 5V and 12V or higher output voltage, respectively.

The output diode has an average current of I_O , and peak current the same as the inductor's peak current. A Schottky diode is recommended and it should be able to handle those currents.

The output voltage ripple can be calculated as Equation 6:

$$\Delta V_O = \frac{I_O \times D}{F_S \times C_O} + I_{LPK} \times ESR \tag{EQ. 6}$$

Where:

- C_O is the output capacitance.
- The ESR is the output capacitor ESR value.

Low ESR capacitors should be used to minimize the output voltage ripple. Multilayer ceramic capacitors (X5R and X7R) are preferred for the output capacitors since they have a low ESR and small packages. Tantalum capacitors also can be used, but they take more board space and have higher ESR. A minimum of 22 μ F output capacitor is sufficient for high output current application. For lower output current, the output capacitor can be smaller, like 4.7 μ F. The capacitor should always have enough voltage rating. In addition to the voltage rating, the output capacitor should also be able to handle the RMS current which is given by Equation 7:

$$I_{CORMS} = \sqrt{(1-D) \times \left(D + \frac{\Delta I_L^2}{2 I_{LAVG}^2} \times \frac{1}{12} \right)} \times I_{LAVG} \tag{EQ. 7}$$

Output Voltage

An external resistor divider is required to divide the output voltage down to the nominal reference voltage. The current drawn by the resistor network should be limited to maintain the overall converter efficiency. The maximum value of the resistor network is limited by the feedback input bias current and the potential for noise being coupled into the feedback pin. A resistor network less than 300k Ω is recommended.

The boost converter output voltage is determined by the relationship in Equation 8:

$$V_{OUT} = V_{FB} \times \left(1 + \frac{R_2}{R_1} \right) \quad (\text{EQ. 8})$$

where V_{FB} slightly changes with V_{DD} . The curve is shown in this data sheet.

RC Filter

The maximum voltage rating for the VDD pin is 12V and is recommended to be about 10V for maximum efficiency to drive the internal MOSFET. The series resistor R_4 in the RC filter connected to V_{DD} can be utilized to reduce the voltage. If V_O is larger than 10V, then Equation 9 shows:

$$R_4 = \frac{V_O - 10}{I_{DD}} \quad (\text{EQ. 9})$$

where I_{DD} is shown in I_{DD} vs f_S curve. Otherwise, R_4 can be 10Ω to 51Ω with $C_4 = 0.1\mu\text{F}$.

Thermal Performance

The EL7515 uses a fused-lead package, which has a reduced θ_{JA} of +100°C/W on a four-layer board and +115°C/W on a two-layer board. Maximizing copper around the ground pins will improve the thermal performance.

This chip also has internal thermal shut-down set at around +135°C to protect the component.

Layout Considerations

The layout is very important for the converter to function properly. Power Ground (\downarrow) and Signal Ground ($\frac{\downarrow}{\oplus}$) should be separated to ensure that the high pulse current in the Power Ground never interferes with the sensitive signals connected to Signal Ground. They should only be connected at one point.

The trace connected to pin 8 (FB) is the most sensitive trace. It needs to be as short as possible and in a “quiet” place, preferably between PGND or SGND traces.

In addition, the bypass capacitor connected to the VDD pin needs to be as close to the pin as possible.

The heat of the chip is mainly dissipated through the SGND pin. Maximizing the copper area around it is preferable. In addition, a solid ground plane is always helpful for the EMI performance.

The demo board is a good example of layout based on these principles. Please refer to the EL7515 Application Brief for the layout. <http://www.intersil.com/data/tb/tb429.pdf>

Mini SO Package Family (MSOP)

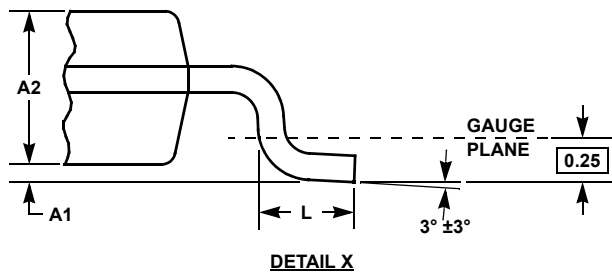
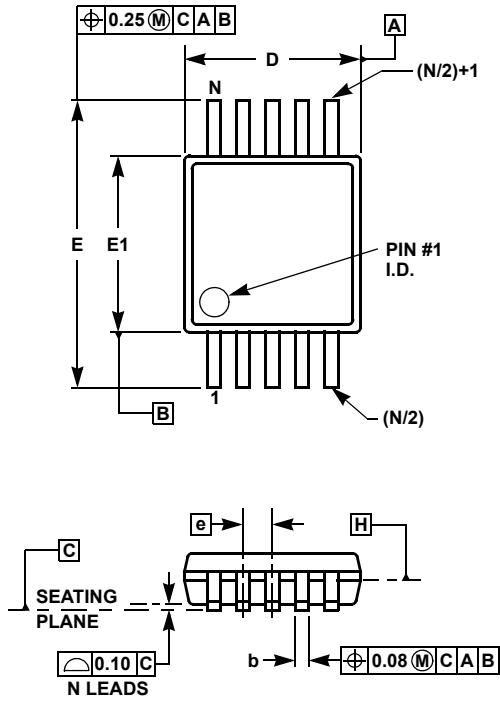

MDP0043
MINI SO PACKAGE FAMILY

SYMBOL	MILLIMETERS		TOLERANCE	NOTES
	MSOP8	MSOP10		
A	1.10	1.10	Max.	-
A1	0.10	0.10	±0.05	-
A2	0.86	0.86	±0.09	-
b	0.33	0.23	+0.07/-0.08	-
c	0.18	0.18	±0.05	-
D	3.00	3.00	±0.10	1, 3
E	4.90	4.90	±0.15	-
E1	3.00	3.00	±0.10	2, 3
e	0.65	0.50	Basic	-
L	0.55	0.55	±0.15	-
L1	0.95	0.95	Basic	-
N	8	10	Reference	-

Rev. D 2/07

NOTES:

1. Plastic or metal protrusions of 0.15mm maximum per side are not included.
2. Plastic interlead protrusions of 0.25mm maximum per side are not included.
3. Dimensions "D" and "E1" are measured at Datum Plane "H".
4. Dimensioning and tolerancing per ASME Y14.5M-1994.

© Copyright Intersil Americas LLC 2003-2007. All Rights Reserved.
All trademarks and registered trademarks are the property of their respective owners.

For additional products, see www.intersil.com/en/products.html

Intersil products are manufactured, assembled and tested utilizing ISO9001 quality systems as noted in the quality certifications found at www.intersil.com/en/support/qualandreliability.html

Intersil products are sold by description only. Intersil may modify the circuit design and/or specifications of products at any time without notice, provided that such modification does not, in Intersil's sole judgment, affect the form, fit or function of the product. Accordingly, the reader is cautioned to verify that datasheets are current before placing orders. Information furnished by Intersil is believed to be accurate and reliable. However, no responsibility is assumed by Intersil or its subsidiaries for its use; nor for any infringements of patents or other rights of third parties which may result from its use. No license is granted by implication or otherwise under any patent or patent rights of Intersil or its subsidiaries.

For information regarding Intersil Corporation and its products, see www.intersil.com

Looking for pricing, stock, or lifecycle information?

Click below to explore more details on WIN SOURCE:

- ⊖ [View EL75151Y-T7 on WIN SOURCE](#)
- ⊖ [Renesas Electronics America](#) Information

Optimize Your Supply Chain with WIN SOURCE Solutions

- ✓ Global Sourcing Solution
- ✓ Obsolete Management
- ✓ Cost Control Management
- ✓ Shortage Management
- ✓ Alternative Solution
- ✓ Excess Inventory Management