



THE DATASHEET OF SF2002E



- *RF Filter for EGSM*
- *Low-loss Design*
- *No Matching Circuit Required*
- *3.0 x 3.0 x 1.3 mm Package*
- *Complies with Directive 2002/95/EC (RoHS)*
- *Moisture Sensitivity Level: 1*

SF2002E

**942.5 MHz
SAW Filter**

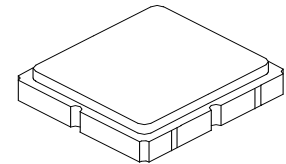

SM3030-6

Absolute Maximum Ratings

Rating	Value	Units
Maximum Input Power	+15	dBm
DC Voltage on any Non-ground Terminal	-5 to +5	VDC
Operable Temperature Range	-45 to +125	°C
Specification Temperature Range	-30 to +85	°C
Storage Temperature Range in Tape and Reel	-40 to +85	°C
Maximum Soldering Profile, 5 Cycles/10 seconds Maximum	265	°C

Electrical Characteristics

Characteristic	Sym	Min	Typ	Max	Units
Nominal Operating Frequency	f_c		942.5		MHz
Passband Insertion Loss, 925 to 960 MHz	IL		2.2	3.0	dB
Amplitude Ripple, 925 to 960 MHz			0.8	1.5	dB _{P-P}
Attenuation Referenced to 0 dB:					
DC to 905 MHz		17.0	20.5		dB
905 to 915 MHz		5.0	15.0		dB
980 to 1000 MHz		13.0	30.0		dB
1000 to 2000 MHz		20.0	23.0		dB
VSWR, 925 to 960 MHz		2.2		2.7	dB
Source Impedance			50		Ω
Load Impedance			50		Ω

Case Style	SM3030-6 3 x 3 mm Nominal Footprint
Lid Symbolization (YY=year, WW=week, S = Shift)	597 <u>YWWS</u>

Electrical Connections

Connection	Terminals
Input	2
Output	5
Ground	All others

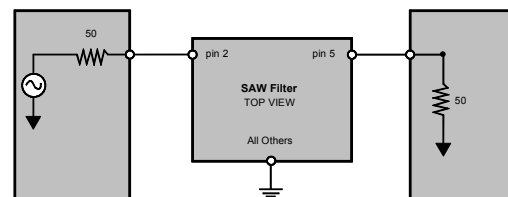

 **CAUTION: Electrostatic Sensitive Device. Observe precautions for handling.**

NOTES:

1. The design, manufacturing process, and specifications of this device are subject to change.
2. US or International patents may apply.
3. RoHS compliant from the first date of manufacture.

FREQUENCY CHARACTERISTICS:

1. wideband response:

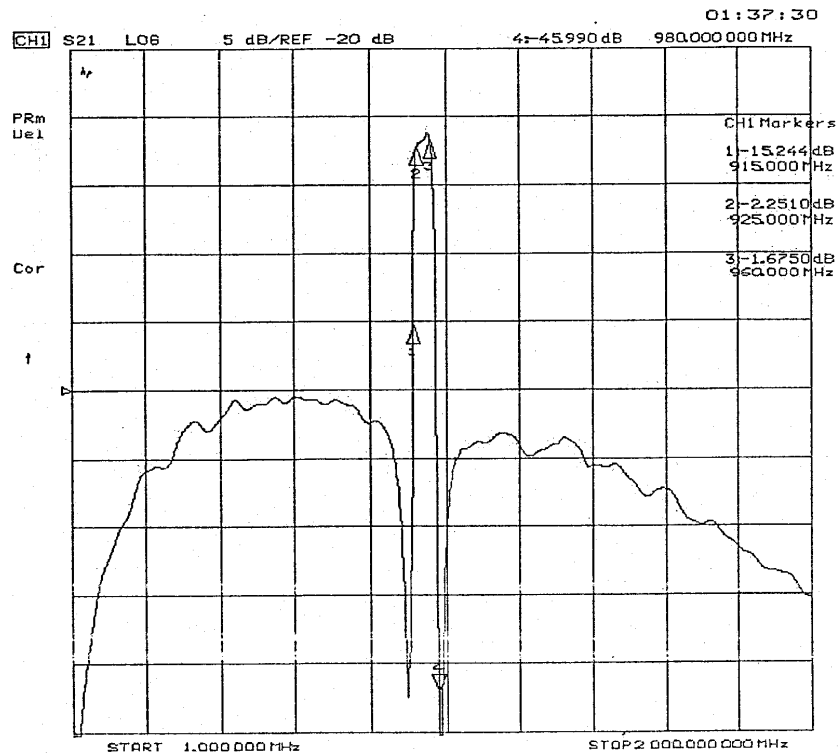
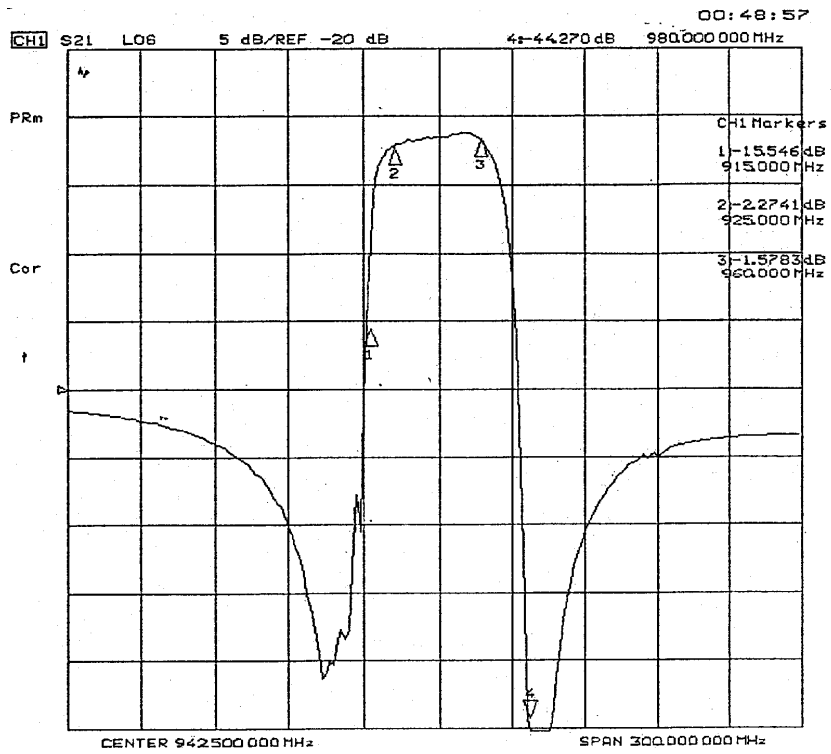

S11 Return Loss & VSWR:

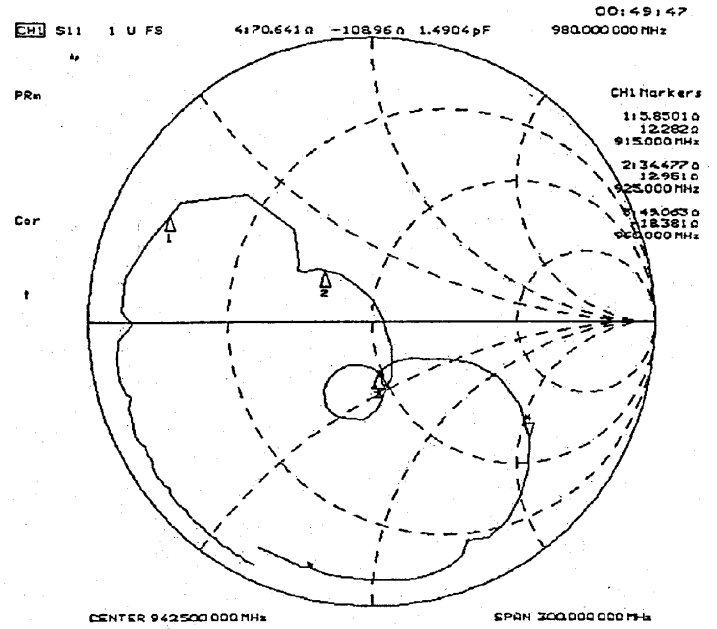
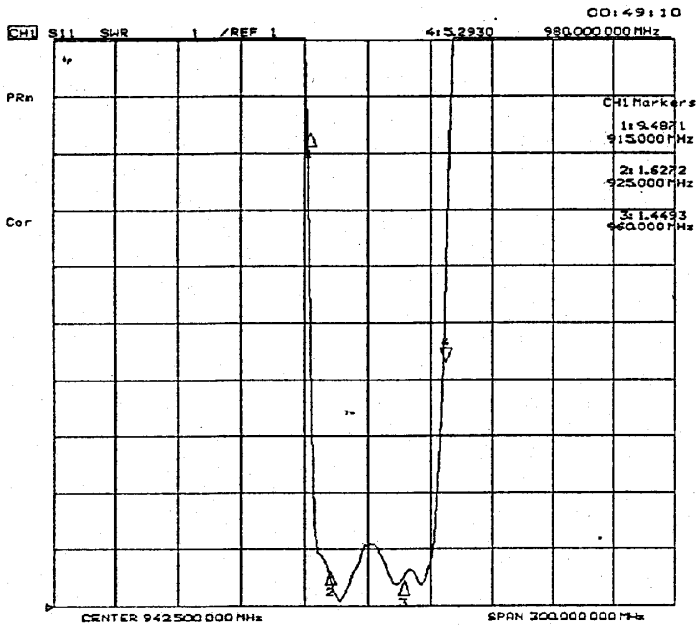

S22 Return Loss & VSWR:

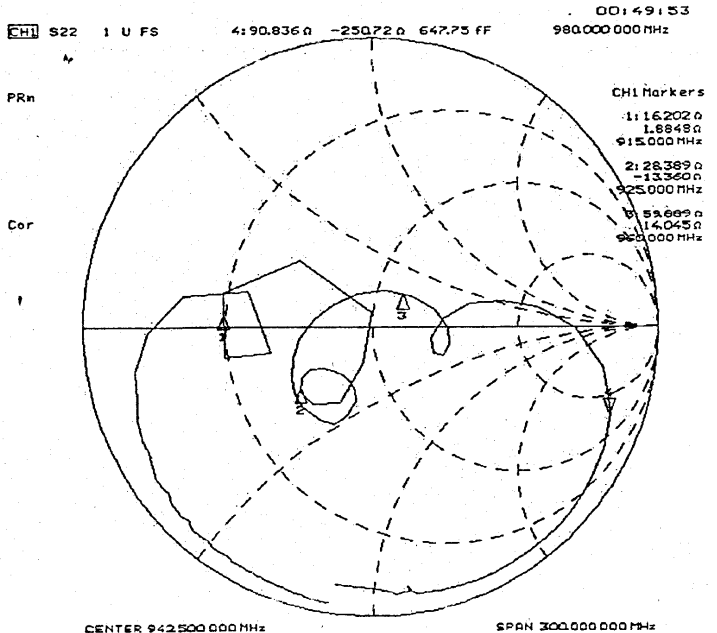
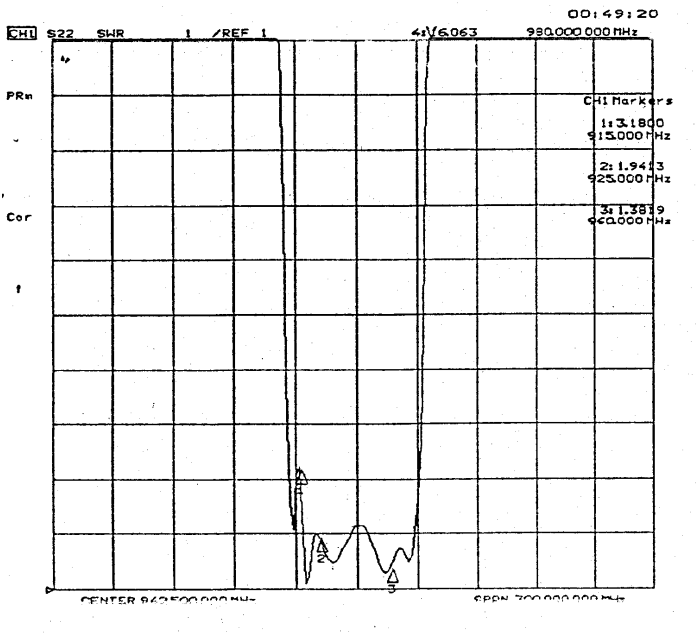

SM3030-6 Case

6-Terminal Ceramic Surface-Mount Case 3.0 X 3.0 mm Nominal Footprint

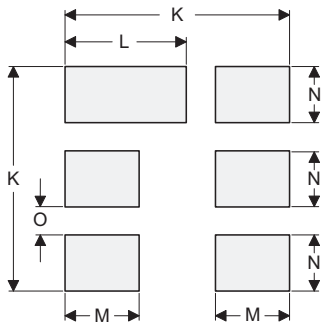
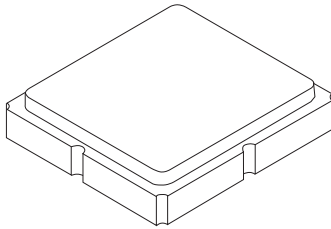

PCB Footprint Top View

Case and PCB Footprint Dimensions

Dimension	mm			Inches		
	Min	Nom	Max	Min	Nom	Max
A	2.87	3.00	3.13	0.113	0.118	0.123
B	2.87	3.00	3.13	0.113	0.118	0.123
C	1.12	1.25	1.38	0.044	0.049	0.054
D	0.77	0.90	1.03	0.030	0.035	0.040
E	2.67	2.80	2.93	0.105	0.110	0.115
F	1.47	1.60	1.73	0.058	0.063	0.068
G	0.72	0.85	0.98	0.028	0.033	0.038
H	1.37	1.50	1.63	0.054	0.059	0.064
I	0.47	0.60	0.73	0.019	0.024	0.029
J	1.17	1.30	1.43	0.046	0.051	0.056
K		3.20			0.126	
L		1.70			0.067	
M		1.05			0.041	
N		0.81			0.032	
O		0.38			0.015	

Case Materials

Materials	
Solder Pad Plating	0.3 to 1.0 μm Gold over 1.27 to 8.89 μm Nickel
Lid Plating	2.0 to 3.0 μm Nickel
Body	Al_2O_3 Ceramic

TOP VIEW

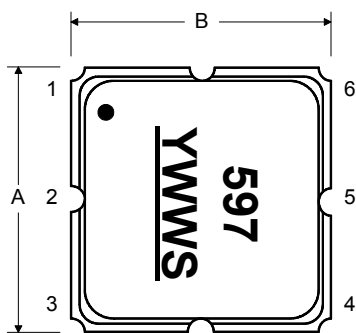

BOTTOM VIEW

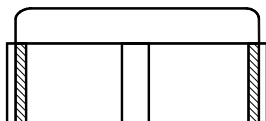
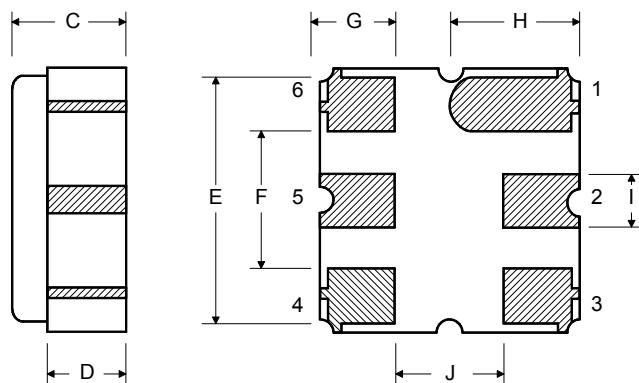

Tape and Reel Specifications

Tape and Reel Standard per ANSI/EIA-481

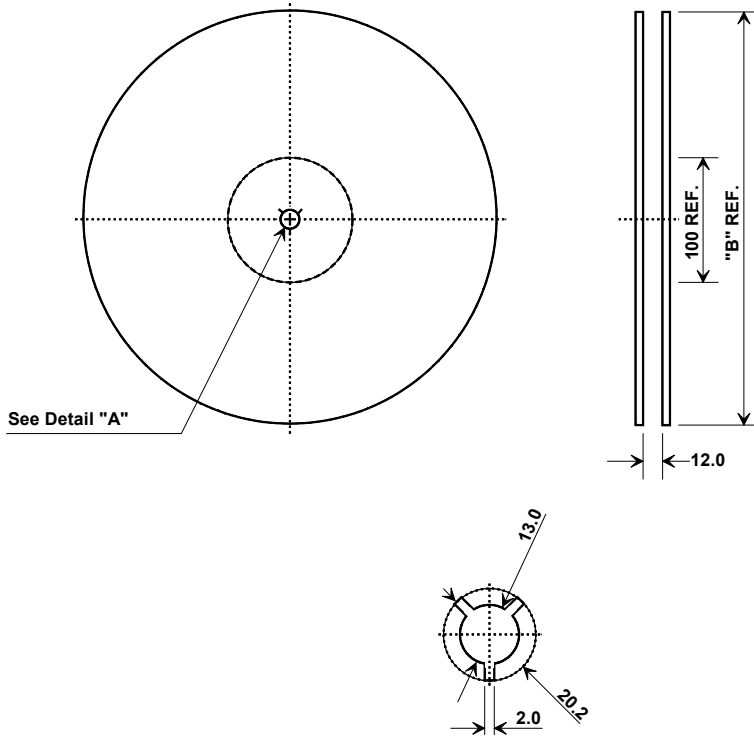

"B"		Quantity Per Reel
Inches	millimeters	
7	178	500
13	330	3000

COMPONENT ORIENTATION

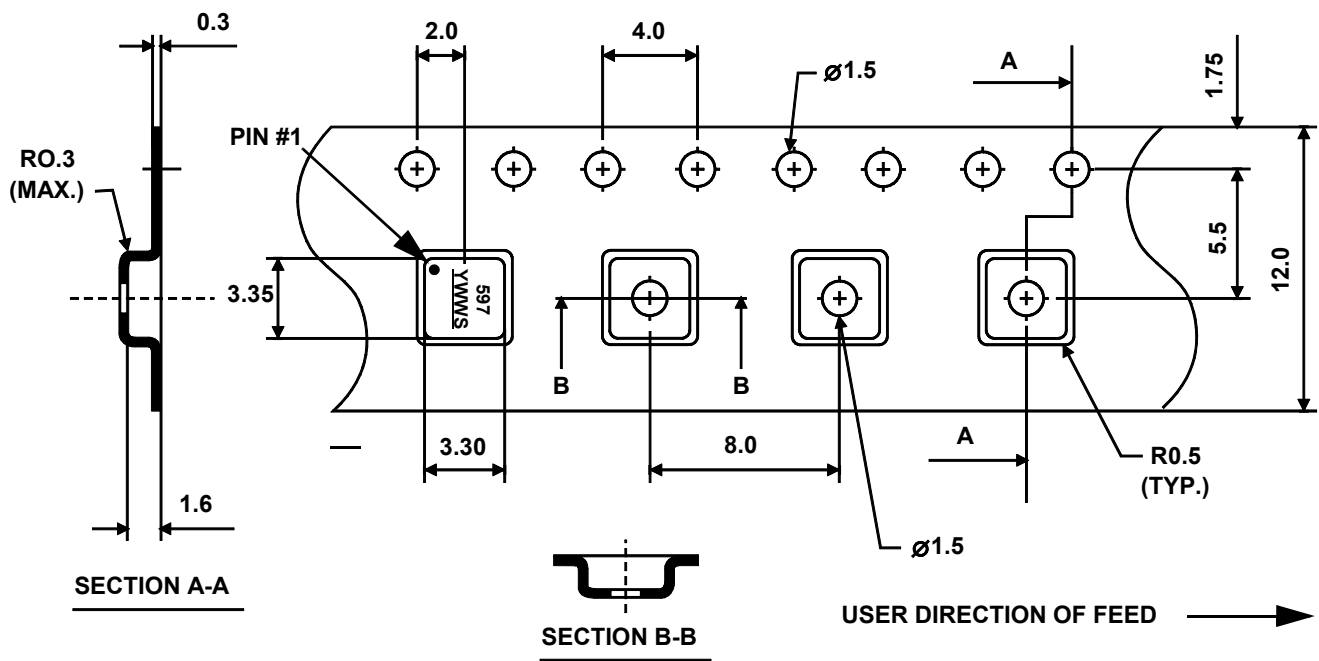

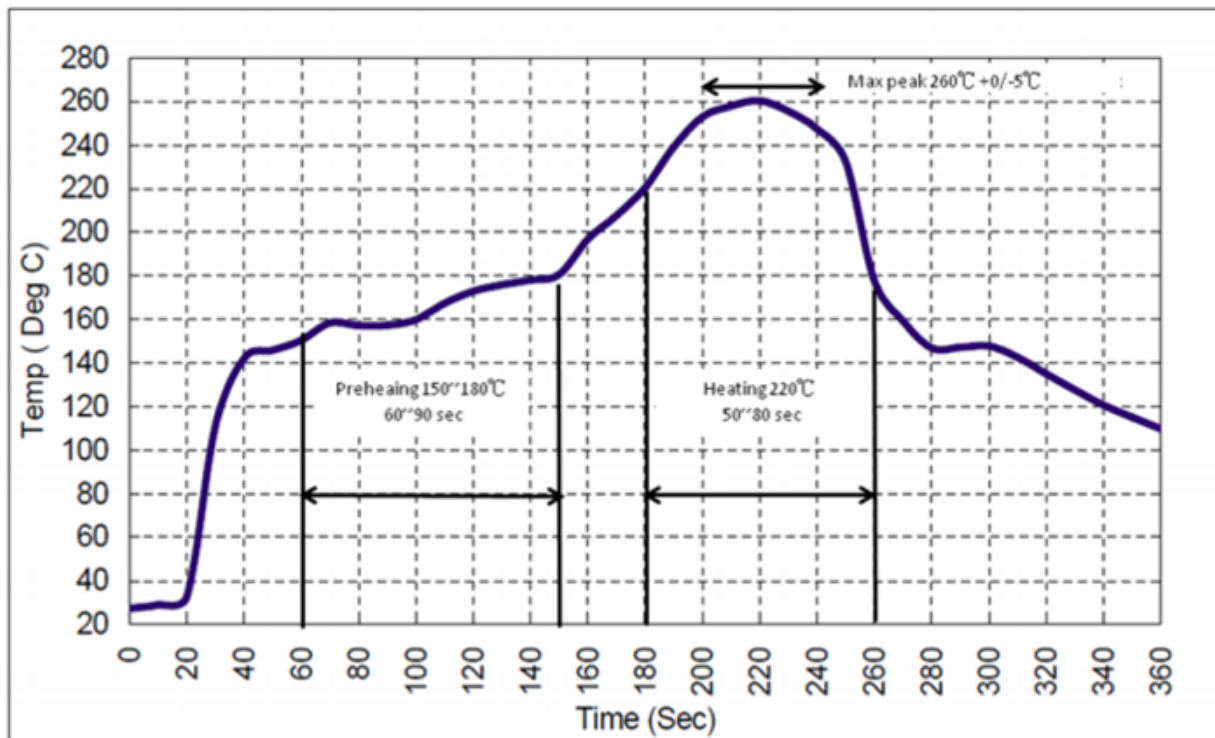

Recommended Reflow Profile

1. Preheating shall be fixed at 150~180°C for 60~90 seconds.
2. Ascending time to preheating temperature 150°C shall be 30 seconds min.
3. Heating shall be fixed at 220°C for 50~80 seconds and at 260°C+0/-5°C peak (10 seconds).
4. Time: 5 times maximum.



Looking for pricing, stock, or lifecycle information?

Click below to explore more details on WIN SOURCE:

-  [View SF2002E on WIN SOURCE](#)
-  [RF Monolithics, Inc Information](#)

Optimize Your Supply Chain with WIN SOURCE Solutions

-  Global Sourcing Solution
-  Obsolete Management
-  Cost Control Management
-  Shortage Management
-  Alternative Solution
-  Excess Inventory Management