



SOLID STATE INC.

46 FARRAND STREET
BLOOMFIELD, NEW JERSEY 07003

www.solidstateinc.com

COMPLEMENTARY SILICON POWER TRANSISTORS

...designed for various specific and general purpose application such as; output and driver stages of amplifiers operating at frequencies from DC to greater than 1.0MHz series, shunt and switching regulators; low and high frequency inverters/converters and many others.

FEATURES:

- * Very Low Collector Saturation Voltage
- * Excellent Linearity
- * Fast Switching
- * PNP Values are Negative, Observe Proper Polarity.

**NPN
D44C
Series**

**PNP
D45C
Series**

**4 AMPERE
COMPLEMENTARY SILICON
POWER TRANSISTORS
30-80 VOLTS
30 WATTS**

MAXIMUM RATINGS

Characteristic	Symbol	D44C1,2,3 D45C1,2,3	D44C4,5,6 D45C4,5,6	D44C7,8,9 D45C7,8,9	D44C10,11,12 D45C10,11,12	Unit
Collector-Emitter Voltage	V_{CEO}	30	45	60	80	V
Collector-Emitter Voltage	V_{CES}	40	55	70	90	V
Emitter-Base Voltage	V_{EBO}	5.0				V
Collector Current - Continuous	I_C	4.0				A
Peak	I_{CM}	6.0				
Base Current	I_B	1.0				A
Total Power Dissipation @ $T_C = 25^\circ C$ Derate above $25^\circ C$	P_D	30				W
		0.24				$W/^\circ C$
Operating and Storage Junction Temperature Range	T_J, T_{STG}	-55 to +150				$^\circ C$

THERMAL CHARACTERISTICS

Characteristic	Symbol	Max	Unit
Thermal Resistance Junction to Case	$R_{\theta JC}$	4.2	$^\circ C/W$

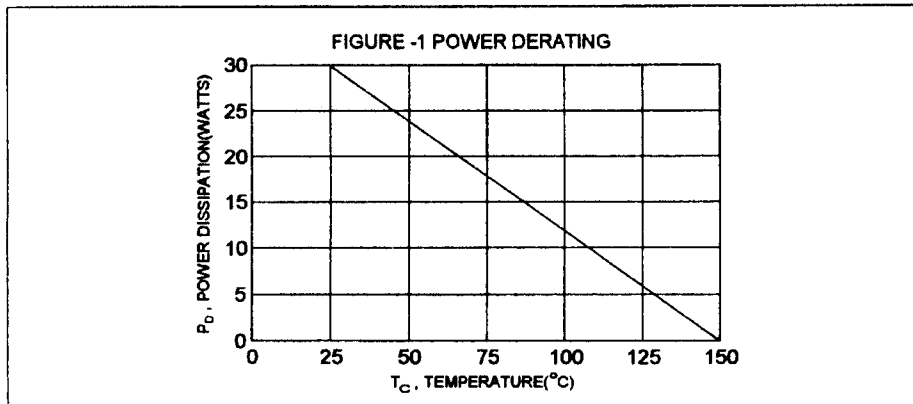

D44C Series NPN / D45C Series PNP

ELECTRICAL CHARACTERISTICS ($T_c = 25^\circ\text{C}$ unless otherwise noted)

Characteristic	Symbol	Min	Max	Unit
----------------	--------	-----	-----	------

OFF CHARACTERISTICS

Collector-Base Cutoff Current ($V_{CE} = \text{Rated } V_{CES}$)	I_{CES}		10	μA
Emitter-Base Cutoff Current ($V_{EB} = 5.0 \text{ V}, I_C = 0$)	I_{EBO}		100	μA

ON CHARACTERISTICS(1)

DC Current Gain ($I_C = 0.2 \text{ A}, V_{CE} = 1.0 \text{ V}$)	D44C3,6,9,12/ D45C3,6,9,12 D44C2,5,8,11 D45C2,5,8,11	h_{FE}	40 100 40	120 220 120	
($I_C = 1.0 \text{ A}, V_{CE} = 1.0 \text{ V}$)	D44C1,4,7,10/D45C1,4,7,10 D44C1,4,7,10/D45C1,4,7,10 D45C2,5,8,11		25 10 20		
($I_C = 2.0 \text{ A}, V_{CE} = 1.0 \text{ V}$)	D44C3,6,9,12/ D45C3,6,9,12 D44C2,5,8,11		20 20		
Collector-Emitter Saturation Voltage ($I_C = 1.0 \text{ A}, I_B = 50 \text{ mA}$)	D44C2,3,5,6,8,9,11,12 D45C2,3,5,6,8,9,11,12	$V_{CE(sat)}$		0.5 0.5	V
($I_C = 1.0 \text{ A}, I_B = 100 \text{ mA}$)	D44C1,4,7,10/D45C1,4,7,10			0.5	
Base-Emitter Saturation Voltage ($I_C = 1.0 \text{ A}, I_B = 100 \text{ mA}$)	All Devices	$V_{BE(sat)}$		1.3	V

DYNAMIC CHARACTERISTICS

Current-Gain Bandwidth Product (2) ($I_C = 20 \text{ mA}, V_{CE} = 4.0 \text{ V}, f = 1.0 \text{ MHz}$)	D44C Series D45C Series	f_T	50(typ) 40(typ)		MHz
--	----------------------------	-------	--------------------	--	-----

SWITCHING CHARACTERISTICS

Rise Time	$V_{CC} = 20 \text{ V}$	D44C Series D45C Series	t_r	0.3 0.2	μs
Storage Time	$I_C = 1.0 \text{ A}$,	D44C Series D45C Series	t_s	0.7 0.6	μs
Fall Time	$I_{B1} = -I_{B2} = 100 \text{ mA}$	D44C Series D45C Series	t_f	0.4 0.3	μs

(1) Pulse Test: Pulse width = 300 μs , Duty Cycle $\leq 2.0\%$

(2) $f_T = |h_{fe}| \cdot f_{max}$

DC CURRENT GAIN

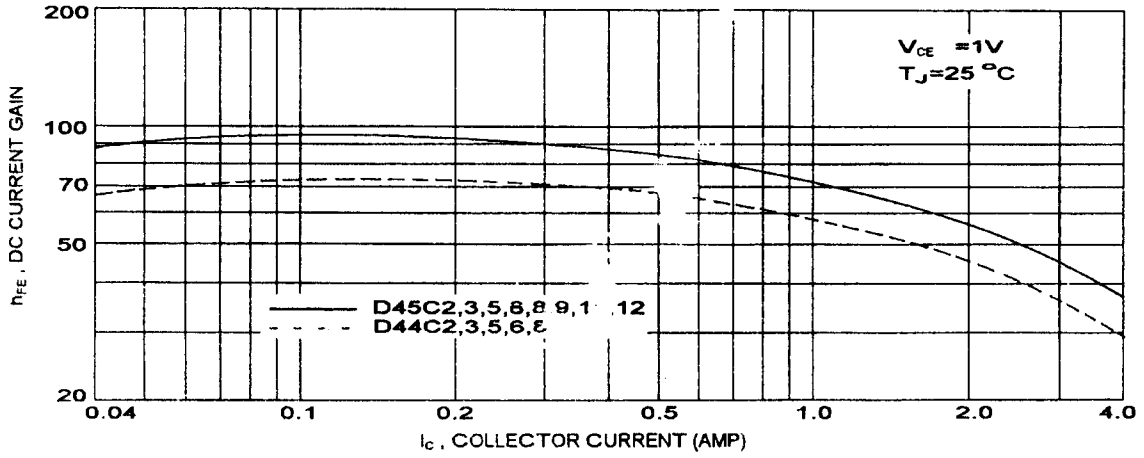

FORWARD BIAS SAFE OPERATING AREA

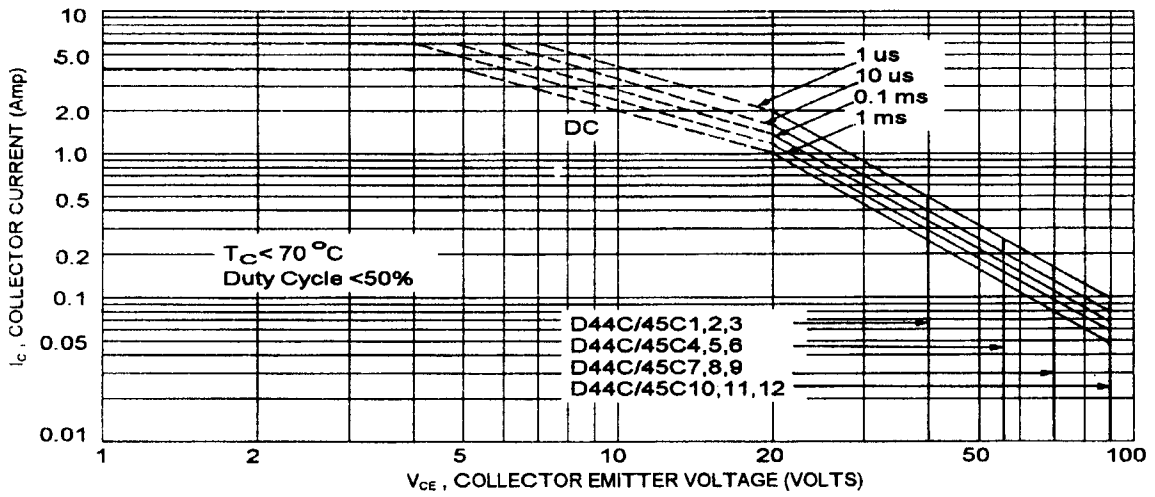

TO-220 Plastic Package

TO-220 Plastic Package

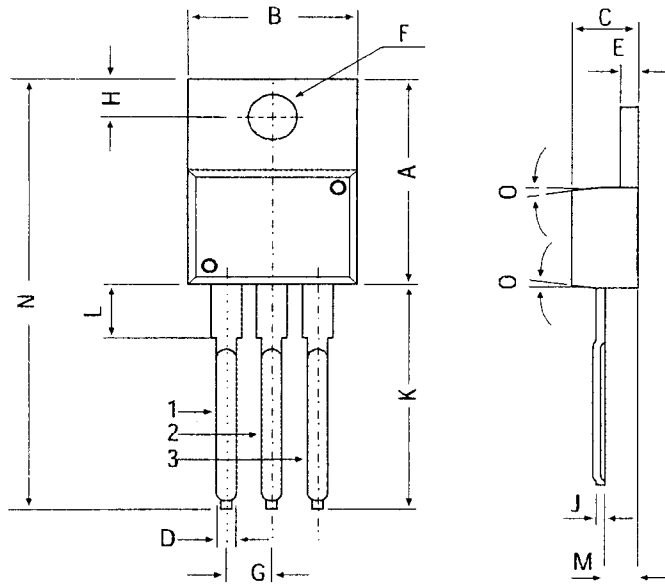

DIM	MIN	MAX
A	14.42	16.51
B	9.63	10.67
C	3.56	4.83
D	—	0.90
E	1.15	1.40
F	3.75	3.88
G	2.29	2.79
H	2.54	3.43
J	—	0.56
K	12.70	14.73
L	2.80	4.07
M	2.03	2.92
N	—	31.24
O	7 DEG	

All dimensions in mm.

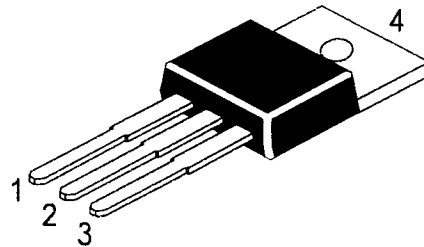



Pin Configuration







1. Base
2. Collector
3. Emitter
4. Collector

Looking for pricing, stock, or lifecycle information?

Click below to explore more details on WIN SOURCE:

-  [View D44C9 on WIN SOURCE](#)
-  [Solid State Inc. Information](#)

Optimize Your Supply Chain with WIN SOURCE Solutions

-  Global Sourcing Solution
-  Obsolete Management
-  Cost Control Management
-  Shortage Management
-  Alternative Solution
-  Excess Inventory Management