



**THE DATASHEET OF
74LVTH16244MEA**



74LVT16244 • 74LVTH16244

Low Voltage 16-Bit Buffer/Line Driver with 3-STATE Outputs

General Description

The LVT16244 and LVTH16244 contain sixteen non-inverting buffers with 3-STATE outputs designed to be employed as a memory and address driver, clock driver, or bus oriented transmitter/receiver. The device is nibble controlled. Individual 3-STATE control inputs can be shorted together for 8-bit or 16-bit operation.

The LVTH16244 data inputs include bushold, eliminating the need for external pull-up resistors to hold unused inputs.

These buffers and line drivers are designed for low-voltage (3.3V) V_{CC} applications, but with the capability to provide a TTL interface to a 5V environment. The LVT16244 and LVTH16244 are fabricated with an advanced BiCMOS technology to achieve high speed operation similar to 5V ABT while maintaining a low power dissipation

Features

- Input and output interface capability to systems at 5V V_{CC}
- Bushold data inputs eliminate the need for external pull-up resistors to hold unused inputs (74LVTH16244), also available without bushold feature (74LVT16244).
- Live insertion/extraction permitted
- Power Up/Down high impedance provides glitch-free bus loading
- Outputs source/sink -32 mA/+64 mA
- Functionally compatible with the 74 series 16244
- Latch-up performance exceeds 500 mA
- ESD performance:
 - Human-body model >2000V
 - Machine model >200V
 - Charged-drive model >1000V
- Also packaged in plastic Fine-Pitch Ball Grid Array (FBGA)

Ordering Code:

Order Number	Package Number	Package Description
74LVT16244G (Note 1)(Note 2)	BGA54A (Preliminary)	54-Ball Fine-Pitch Ball Grid Array (FBGA), JEDEC MO-205, 5.5mm Wide
74LVT16244MEA (Note 2)	MS48A	48-Lead Small Shrink Outline Package (SSOP), JEDEC MO-118, 0.300" Wide
74LVT16244MTD (Note 2)	MTD48	48-Lead Thin Shrink Small Outline Package (TSSOP), JEDEC MO-153, 6.1mm Wide
74LVTH16244G (Note 1)(Note 2)	BGA54A	54-Ball Fine-Pitch Ball Grid Array (FBGA), JEDEC MO-205, 5.5mm Wide
74LVTH16244MEA (Note 2)	MS48A	48-Lead Small Shrink Outline Package (SSOP), JEDEC MO-118, 0.300" Wide
74LVTH16244MTD (Note 2)	MTD48	48-Lead Thin Shrink Small Outline Package (TSSOP), JEDEC MO-153, 6.1mm Wide

Note 1: Ordering code "G" indicates Trays.

Note 2: Device also available in Tape and Reel. Specify by appending suffix letter "X" to the ordering code.

Logic Symbol

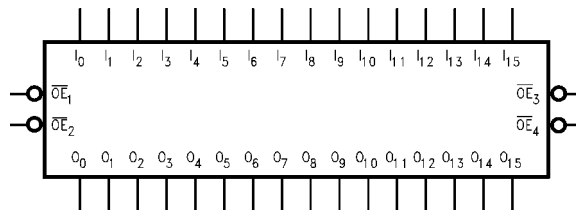

Connection Diagrams

Pin Assignment for SSOP and TSSOP

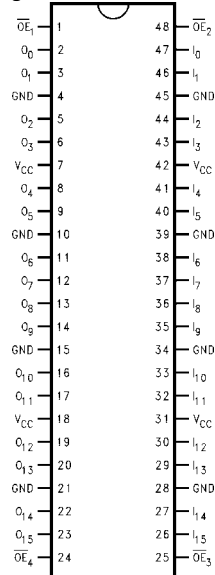

Pin Assignment for FBGA

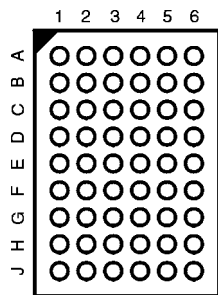

(Top Thru View)

Logic Diagram

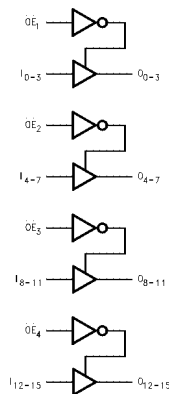

Pin Descriptions

Pin Names	Description
\overline{OE}_n	Output Enable Inputs (Active LOW)
I_0-I_{15}	Inputs
O_0-O_{15}	Outputs
NC	No Connect

FBGA Pin Assignments

	1	2	3	4	5	6
A	O_0	NC	\overline{OE}_1	\overline{OE}_2	NC	I_0
B	O_2	O_1	NC	NC	I_1	I_2
C	O_4	O_3	V_{CC}	V_{CC}	I_3	I_4
D	O_6	O_5	GND	GND	I_5	I_6
E	O_8	O_7	GND	GND	I_7	I_8
F	O_{10}	O_9	GND	GND	I_9	I_{10}
G	O_{12}	O_{11}	V_{CC}	V_{CC}	I_{11}	I_{12}
H	O_{14}	O_{13}	NC	NC	I_{13}	I_{14}
J	O_{15}	NC	\overline{OE}_4	\overline{OE}_3	NC	I_{15}

Truth Table

Inputs		Outputs
\overline{OE}_1	I_0-I_3	O_0-O_3
L	L	L
L	H	H
H	X	Z
Inputs		Outputs
\overline{OE}_2	I_4-I_7	O_4-O_7
L	L	L
L	H	H
H	X	Z
Inputs		Outputs
\overline{OE}_3	I_8-I_{11}	O_8-O_{11}
L	L	L
L	H	H
H	X	Z
Inputs		Outputs
\overline{OE}_4	$I_{12}-I_{15}$	$O_{12}-O_{15}$
L	L	L
L	H	H
H	X	Z

H = High Voltage Level
 L = Low Voltage Level
 X = Immaterial
 Z = High Impedance

Functional Description

The LVT16244 and LVTH16244 contain sixteen non-inverting buffers with 3-STATE outputs. The device is nibble (4-bits) controlled with each nibble functioning identically, but independent of the other. The control pins can be shorted together to obtain full 16-bit operation.

Absolute Maximum Ratings ^(Note 3)					
Symbol	Parameter	Value	Conditions		Units
V _{CC}	Supply Voltage	-0.5 to +4.6			V
V _I	DC Input Voltage	-0.5 to +7.0			V
V _O	Output Voltage	-0.5 to +7.0	Output in 3-STATE		V
		-0.5 to +7.0	Output in HIGH or LOW State (Note 4)		
I _{IK}	DC Input Diode Current	-50	V _I < GND		mA
I _{OK}	DC Output Diode Current	-50	V _O < GND		mA
I _O	DC Output Current	64	V _O > V _{CC} Output at HIGH State		mA
		128	V _O > V _{CC} Output at LOW State		
I _{CC}	DC Supply Current per Supply Pin	±64			mA
I _{GND}	DC Ground Current per Ground Pin	±128			mA
T _{STG}	Storage Temperature	-65 to +150			°C

Recommended Operating Conditions					
Symbol	Parameter	Min	Max	Units	
V _{CC}	Supply Voltage	2.7	3.6	V	
V _I	Input Voltage	0	5.5	V	
I _{OH}	HIGH Level Output Current		-32	mA	
I _{OL}	LOW Level Output Current		64	mA	
T _A	Free Air Operating Temperature	-40	+85	°C	
Δt/ΔV	Input Edge Rate, V _{IN} = 0.8V–2.0V, V _{CC} = 3.0V	0	10	ns/V	

Note 3: Absolute Maximum continuous ratings are those values beyond which damage to the device may occur. Exposure to these conditions or conditions beyond those indicated may adversely affect device reliability. Functional operation under absolute maximum rated conditions is not implied.

Note 4: I_O Absolute Maximum Rating must be observed.

DC Electrical Characteristics

Symbol	Parameter	V _{CC} (V)	T _A = -40°C to +85°C		Units	Conditions	
			Min	Max			
V _{IK}	Input Clamp Diode Voltage	2.7		-1.2	V	I _I = -18 mA	
V _{IH}	Input HIGH Voltage	2.7–3.6	2.0		V	V _O ≤ 0.1V or	
V _{IL}	Input LOW Voltage	2.7–3.6		0.8	V	V _O ≥ V _{CC} - 0.1V	
V _{OH}	Output HIGH Voltage	2.7–3.6	V _{CC} - 0.2		V	I _{OH} = -100 μA	
		2.7	2.4			I _{OH} = -8 mA	
		3.0	2.0			I _{OH} = -32 mA	
V _{OL}	Output LOW Voltage	2.7		0.2	V	I _{OL} = 100 μA	
		2.7		0.5		I _{OL} = 24 mA	
		3.0		0.4		I _{OL} = 16 mA	
		3.0		0.5		I _{OL} = 32 mA	
		3.0		0.55		I _{OL} = 64 mA	
I _{I(HOLD)} (Note 5)	Bushold Input Minimum Drive	3.0	75		μA	V _I = 0.8V	
			-75			V _I = 2.0V	
I _{I(OD)} (Note 5)	Bushold Input Over-Drive Current to Change State	3.0	500		μA	(Note 6)	
			-500			(Note 7)	
I _I	Input Current	3.6		10	μA	V _I = 5.5V	
		Control Pins	3.6			±1	V _I = 0V or V _{CC}
			Data Pins	3.6			-5
				1	V _I = V _{CC}		
I _{OFF}	Power Off Leakage Current	0		±100	μA	0V ≤ V _I or V _O ≤ 5.5V	
I _{PU/PD}	Power Up/Down 3-STATE Current	0 – 1.5V		±100	μA	V _O = 0.5V to 3.0V V _I = GND or V _{CC}	
I _{OZL}	3-STATE Output Leakage Current	3.6		-5	μA	V _O = 0.5V	
I _{OZH}	3-STATE Output Leakage Current	3.6		5	μA	V _O = 3.0V	
I _{OZH+}	3-STATE Output Leakage Current	3.6		10	μA	V _{CC} < V _O ≤ 5.5V	

DC Electrical Characteristics (Continued)

Symbol	Parameter	V _{CC} (V)	T _A = -40°C to +85°C		Units	Conditions
			Min	Max		
I _{CC} H	Power Supply Current	3.6		0.19	mA	Outputs High
I _{CC} L	Power Supply Current	3.6		5.0	mA	Outputs Low
I _{CC} Z	Power Supply Current	3.6		0.19	mA	Outputs Disabled
I _{CC} Z ⁺	Power Supply Current	3.6		0.19	mA	V _{CC} ≤ V _O ≤ 5.5V, Outputs Disabled
ΔI _{CC}	Increase in Power Supply Current (Note 8)	3.6		0.2	mA	One Input at V _{CC} - 0.6V Other Inputs at V _{CC} or GND

Note 5: Applies to bushold versions only (LVTH16244).

Note 6: An external driver must source at least the specified current to switch from LOW-to-HIGH.

Note 7: An external driver must sink at least the specified current to switch from HIGH-to-LOW.

Note 8: This is the increase in supply current for each input that is at the specified voltage level rather than V_{CC} or GND.

Dynamic Switching Characteristics (Note 9)

Symbol	Parameter	V _{CC} (V)	T _A = 25°C			Units	Conditions C _L = 50 pF, R _L = 500Ω
			Min	Typ	Max		
V _{OLP}	Quiet Output Maximum Dynamic V _{OL}	3.3		0.8		V	(Note 10)
V _{OLV}	Quiet Output Minimum Dynamic V _{OL}	3.3		-0.8		V	(Note 10)

Note 9: Characterized in SSOP package. Guaranteed parameter, but not tested.

Note 10: Max number of outputs defined as (n). n-1 data inputs are driven 0V to 3V. Output under test held LOW.

AC Electrical Characteristics

Symbol	Parameter	T _A = -40°C to +85°C C _L = 50 pF, R _L = 500Ω				Units
		V _{CC} = 3.3V ± 0.3V		V _{CC} = 2.7V		
		Min	Max	Min	Max	
t _{PLH}	Propagation Delay Data to Output	1.2	3.5	1.2	3.9	ns
t _{PHL}		1.2	3.5	1.2	3.9	
t _{PZH}	Output Enable Time	1.2	4.0	1.2	5.0	ns
t _{PZL}		1.2	5.0	1.2	6.5	
t _{PHZ}	Output Disable Time	2.0	4.7	2.0	5.2	ns
t _{PLZ}		1.5	4.2	1.5	4.4	
t _{OSHL}	Output to Output Skew (Note 11)		1.0		1.0	ns
t _{OSLH}						

Note 11: Skew is defined as the absolute value of the difference between the actual propagation delay for any two separate outputs of the same device. The specification applies to any outputs switching in the same direction, either HIGH-to-LOW (t_{OSHL}) or LOW-to-HIGH (t_{OSLH}).

Capacitance (Note 12)

Symbol	Parameter	Conditions	Typical	Units
C _{IN}	Input Capacitance	V _{CC} = 0V, V _I = 0V or V _{CC}	4	pF
C _{OUT}	Output Capacitance	V _{CC} = 3.0V, V _O = 0V or V _{CC}	8	pF

Note 12: Capacitance is measured at frequency f = 1 MHz, per MIL-STD-883, Method 3012.

Physical Dimensions inches (millimeters) unless otherwise noted

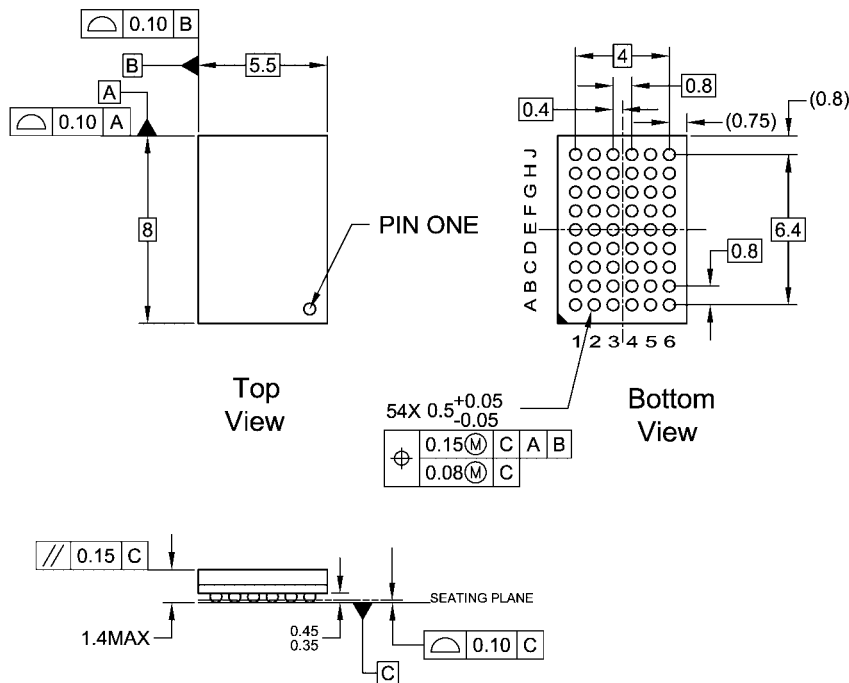

NOTES:

- A. THIS PACKAGE CONFORMS TO JEDEC M0-205
- B. ALL DIMENSIONS IN MILLIMETERS
- C. LAND PATTERN RECOMMENDATION: NSMD (Non Solder Mask Defined)
.35MM DIA PADS WITH A SOLDERMASK OPENING OF .45MM CONCENTRIC TO PADS
- D. DRAWING CONFORMS TO ASME Y14.5M-1994

BGA54ArevD

**54-Ball Fine-Pitch Ball Grid Array (FBGA), JEDEC M0-205, 5.5mm Wide
Package Number BGA54A**

Physical Dimensions inches (millimeters) unless otherwise noted (Continued)

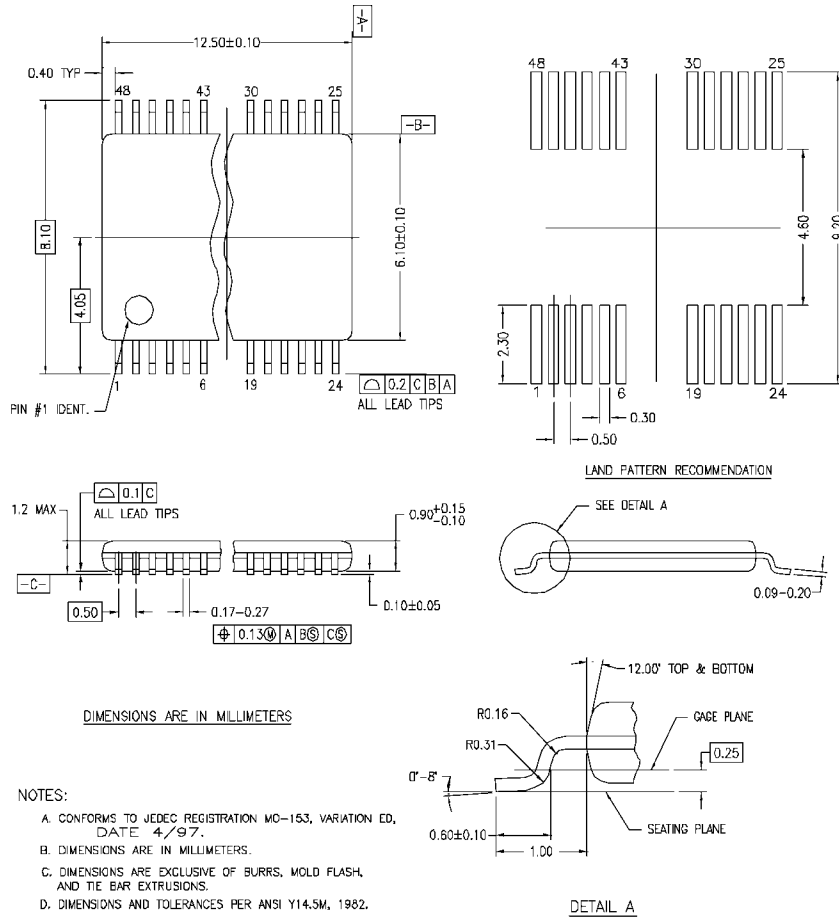

Fairchild does not assume any responsibility for use of any circuitry described, no circuit patent licenses are implied and Fairchild reserves the right at any time without notice to change said circuitry and specifications.

LIFE SUPPORT POLICY



FAIRCHILD'S PRODUCTS ARE NOT AUTHORIZED FOR USE AS CRITICAL COMPONENTS IN LIFE SUPPORT DEVICES OR SYSTEMS WITHOUT THE EXPRESS WRITTEN APPROVAL OF THE PRESIDENT OF FAIRCHILD SEMICONDUCTOR CORPORATION. As used herein:

1. Life support devices or systems are devices or systems which, (a) are intended for surgical implant into the body, or (b) support or sustain life, and (c) whose failure to perform when properly used in accordance with instructions for use provided in the labeling, can be reasonably expected to result in a significant injury to the user.
2. A critical component in any component of a life support device or system whose failure to perform can be reasonably expected to cause the failure of the life support device or system, or to affect its safety or effectiveness.

www.fairchildsemi.com

Looking for pricing, stock, or lifecycle information?

Click below to explore more details on WIN SOURCE:

-  [View 74LVTH16244MEA on WIN SOURCE](#)
-  [Fairchild/ON Semiconductor Information](#)

Optimize Your Supply Chain with WIN SOURCE Solutions

-  Global Sourcing Solution
-  Obsolete Management
-  Cost Control Management
-  Shortage Management
-  Alternative Solution
-  Excess Inventory Management