



THE DATASHEET OF HMHA2801B



HMHA281, HMHA2801 Series

4-Pin Half-Pitch Mini-Flat Phototransistor Optocouplers

Description

The HMHA281 and HMHA2801 series devices consist of a gallium arsenide infrared emitting diode driving a silicon phototransistor in a compact 4-pin mini-flat package. The lead pitch is 1.27 mm.

Features

- Compact 4-Pin Package
 - ◆ 2.4 mm Maximum Standoff Height
 - ◆ Half-Pitch Leads for Optimum Board Space Savings
- Current Transfer Ratio:
 - ◆ HMHA281: 50% to 600%
 - ◆ HMHA2801: 80% to 600%
 - ◆ HMHA2801A: 80% to 160%
 - ◆ HMHA2801B: 130% to 260%
 - ◆ HMHA2801C: 200% to 400%
- Safety and Regulatory Approvals:
 - ◆ UL1577, 3.750 VAC_{RMS} for 1 Minute
 - ◆ DIN-EN/IEC60747-5-5, 565 V Peak Working Insulation Voltage
- These Devices are Pb-Free and are RoHS Compliant

Applications

- Digital Logic Inputs
- Microprocessor Inputs
- Power Supply Monitor
- Twisted Pair Line Receiver
- Telephone Line Receiver



ON Semiconductor®

www.onsemi.com

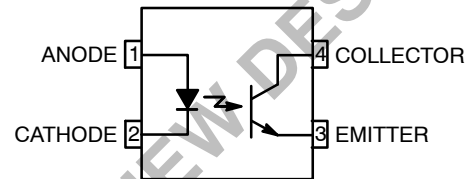

Phototransistor Optocoupler

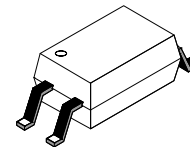

MPF4
CASE 100AL

MARKING DIAGRAM

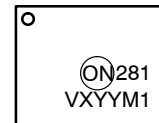

ON = ON Semiconductor Logo
281 = Device Number
V = DIN EN/IEC60747-5-5 Option (only appears on component ordered with this option)
X = One-Digit Year Code, e.g., "5"
YY = Digit Work Week, Ranging from "01" to "53"
M1 = Assembly Package Code

ORDERING INFORMATION

See detailed ordering and shipping information on page 7 of this data sheet.

HMHA281, HMHA2801 Series

Table 1. SAFETY AND INSULATION RATINGS (As per DIN EN/IEC 60747-5-5, this optocoupler is suitable for “safe electrical insulation” only within the safety limit data. Compliance with the safety ratings shall be ensured by means of protective circuits.)

Parameter		Characteristics
Installation Classifications per DIN VDE 0110/1.89 Table 1, For Rated Mains Voltage	< 150 V _{RMS}	I–IV
	< 300 V _{RMS}	I–III
Climatic Classification		55/100/21
Pollution Degree (DIN VDE 0110/1.89)		2
Comparative Tracking Index		175

Symbol	Parameter	Value	Unit
V _{PR}	Input-to-Output Test Voltage, Method A, V _{IORM} × 1.6 = V _{PR} , Type and Sample Test with t _m = 10 s, Partial Discharge < 5 pC	904	V _{peak}
	Input-to-Output Test Voltage, Method B, V _{IORM} × 1.875 = V _{PR} , 100% Production Test with t _m = 1 s, Partial Discharge < 5 pC	1060	V _{peak}
V _{IORM}	Maximum Working Insulation Voltage	565	V _{peak}
V _{IOTM}	Highest Allowable Over-Voltage	4000	V _{peak}
	External Creepage	≥5	mm
	External Clearance	≥5	mm
DTI	Distance Through Insulation (Insulation Thickness)	≥0.4	mm
T _S	Case Temperature (Note 1)	150	°C
I _{S, INPUT}	Input Current (Note 1)	200	mA
P _{S, OUTPUT}	Output Power (Note 1)	300	mW
R _{IO}	Insulation Resistance at T _S , V _{IO} = 500 V (Note 1)	>10 ⁹	Ω

1. Safety limit values – maximum values allowed in the event of a failure.

HMHA281, HMHA2801 Series

ABSOLUTE MAXIMUM RATINGS (T_C = 25°C, Unless otherwise specified)

Symbol	Parameter	Value	Unit
--------	-----------	-------	------

TOTAL PACKAGE

T _{STG}	Storage Temperature	-55 to +125	°C
T _{OPR}	Operating Temperature	-55 to +100	°C
T _J	Junction Temperature	-40 to +125	°C
P _D	Total Device Power Dissipation @ T _A = 25°C	210	mW
	Derate Above 25°C	2.1	mW/°C

EMITTER

I _{F (avg)}	Continuous Forward Current	50	mA
I _{F (pk)}	Peak Forward Current (1 μs pulse, 300 pps)	1	A
V _R	Reverse Input Voltage	6	V
P _D	LED Power Dissipation @ T _A = 25°C	60	mW
	Derate Above 25°C	0.6	mW/°C

DETECTOR

I _C	Continuous Collector Current	50	mA
V _{CEO}	Collector-Emitter Voltage	80	V
V _{ECO}	Emitter-Collector Voltage	7	V
P _D	Detector Power Dissipation @ T _A = 25°C	150	mW
	Derate Above 25°C	1.5	mW/°C

Stresses exceeding those listed in the Maximum Ratings table may damage the device. If any of these limits are exceeded, device functionality should not be assumed, damage may occur and reliability may be affected.

HMHA281, HMHA2801 Series

ELECTRICAL CHARACTERISTICS (T_A = 25°C)

Symbol	Parameter	Test Conditions	Device	Min	Typ	Max	Unit
--------	-----------	-----------------	--------	-----	-----	-----	------

INDIVIDUAL COMPONENT CHARACTERISTICS

Emitter

V _F	Forward Voltage	I _F = 10 mA	All	1.0	–	1.3	V
I _R	Reverse Current	V _R = 5 V	All	–	–	5	μA

Detector

BV _{CEO}	Breakdown Voltage Collector to Emitter	I _C = 0.5 mA, I _F = 0	All	80	–	–	V
BV _{ECO}	Emitter to Collector	I _E = 100 μA, I _F = 0	All	7	–	–	
I _{CEO}	Collector Dark Current	V _{CE} = 80 V, I _F = 0	All	–	–	100	nA
C _{CE}	Capacitance	V _{CE} = 0 V, f = 1 MHz	All	–	10	–	pF

TRANSFER CHARACTERISTICS

CTR	DC Current Transfer Ratio	I _F = 5 mA, V _{CE} = 5 V	HMHA281	50	–	600	%
			HMHA2801	80	–	600	
			HMHA2801A	80	–	160	
			HMHA2801B	130	–	260	
			HMHA2801C	200	–	400	
V _{CE (SAT)}	Saturation Voltage	I _F = 8 mA, I _C = 2.4 mA	HMHA281	–	–	0.4	V
		I _F = 10 mA, I _C = 2 mA	HMHA2801, HMHA2801A, HMHA2801B, HMHA2801C	–	–	0.3	
t _r	Rise Time (Non-Saturated)	I _C = 2 mA, V _{CE} = 5 V, R _L = 100 Ω	All	–	3	–	μs
t _f	Fall Time (Non-Saturated)	I _C = 2 mA, V _{CE} = 5 V, R _L = 100 Ω	All	–	3	–	

ISOLATION CHARACTERISTICS

V _{ISO}	Steady State Isolation Voltage	1 Minute	All	3750	–	–	VAC _{RMS}
------------------	--------------------------------	----------	-----	------	---	---	--------------------

Product parametric performance is indicated in the Electrical Characteristics for the listed test conditions, unless otherwise noted. Product performance may not be indicated by the Electrical Characteristics if operated under different conditions.

HMHA281, HMHA2801 Series

TYPICAL PERFORMANCE CHARACTERISTICS

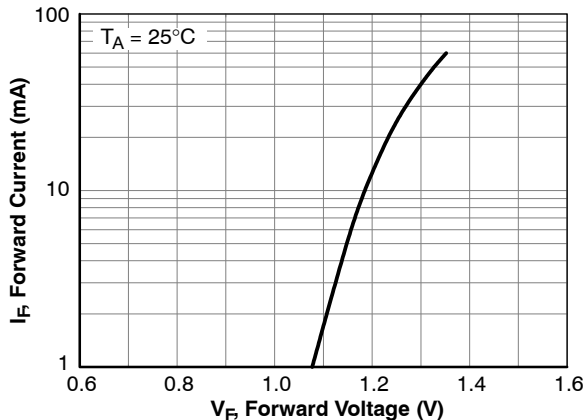

Figure 1. Forward Current vs. Forward Voltage

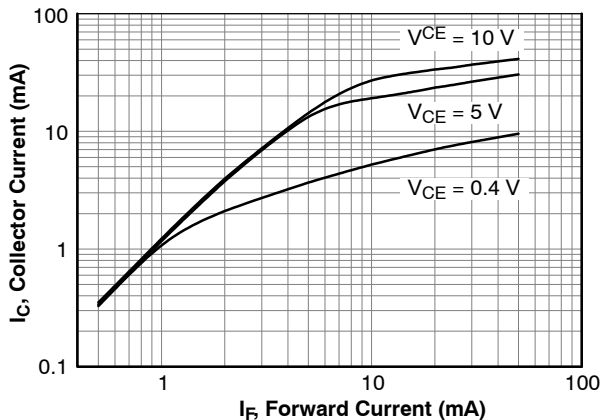

Figure 2. Collector Current vs. Forward Current

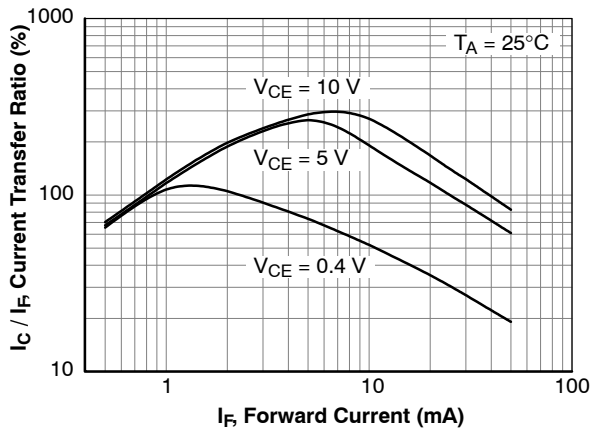

Figure 3. Current Transfer Ratio vs. Forward Current

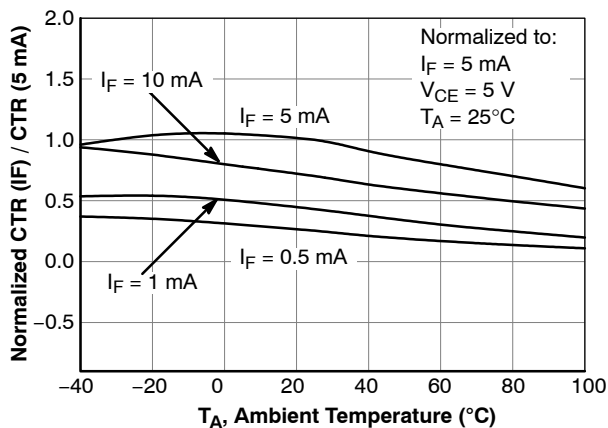

Figure 4. Normalized CTR vs. Temperature

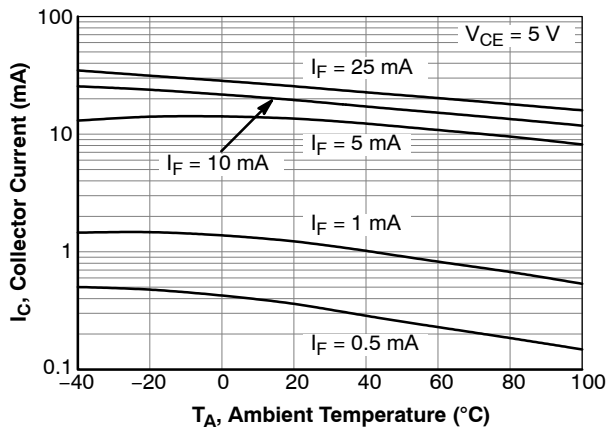

Figure 5. Collector Current vs. Temperature

HMHA281, HMHA2801 Series

TYPICAL PERFORMANCE CHARACTERISTICS (Continued)

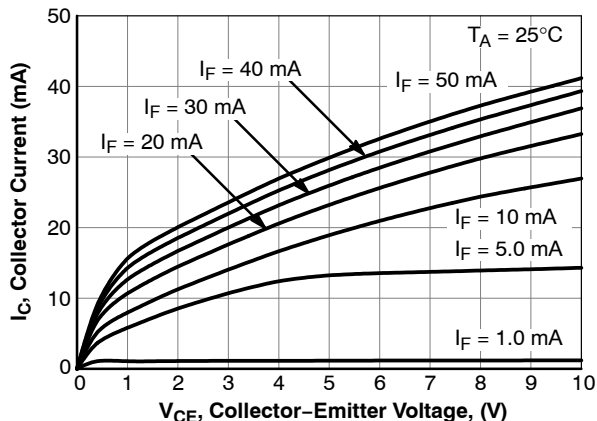

Figure 6. Collector Current vs. Collector-Emitter Voltage

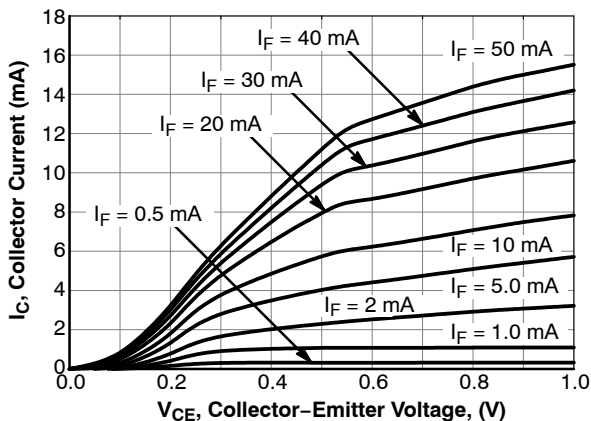

Figure 7. Collector Current vs. Collector-Emitter Voltage

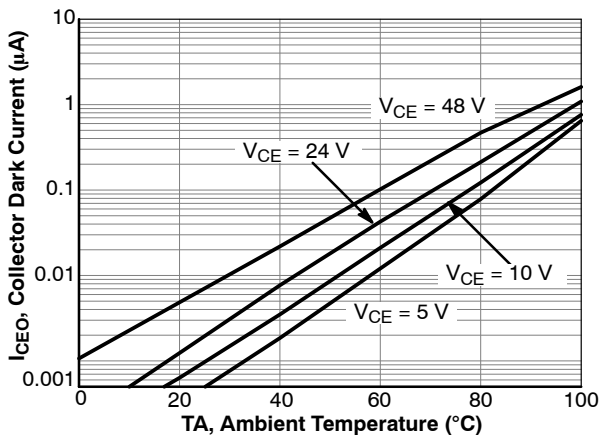

Figure 8. Collector Dark Current vs. Temperature

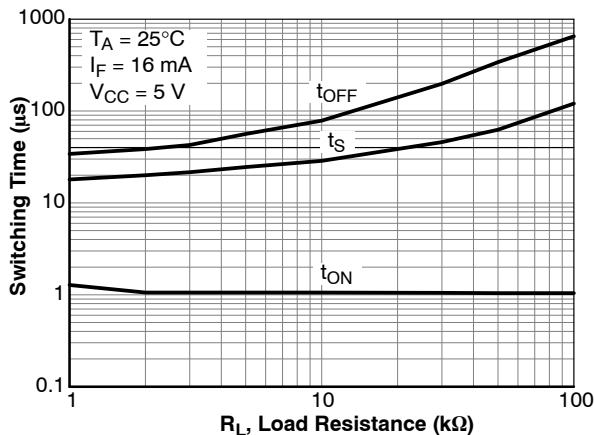

Figure 9. Switching Time vs. Load Resistance

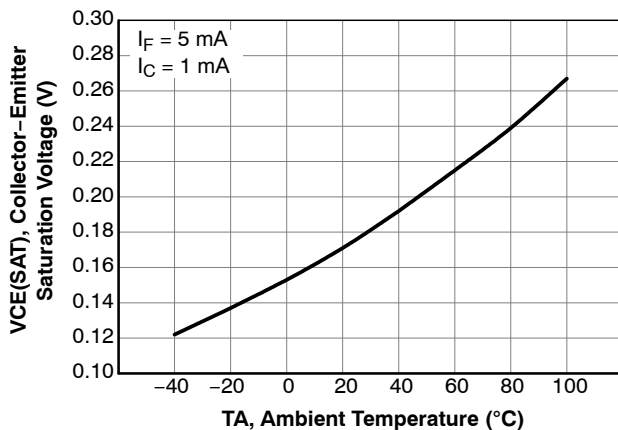

Figure 10. Collector-Emitter Saturation Voltage vs Temperature

HMHA281, HMHA2801 Series

REFLOW PROFILE

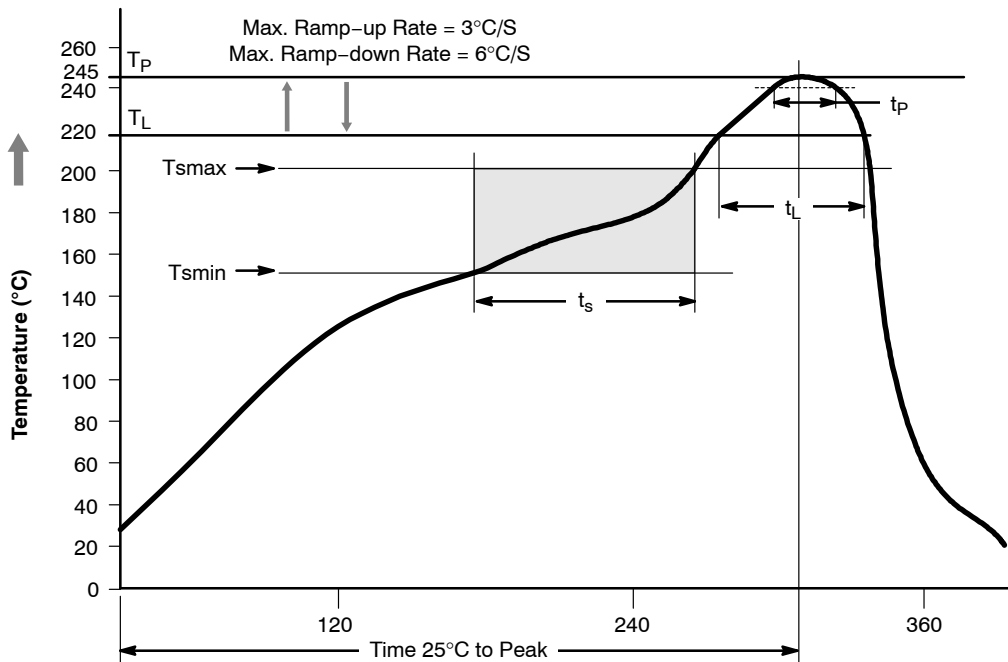

Figure 11. Reflow Profile

Profile Feature	Pb-Free Assembly Profile
Temperature Minimum (T_{smin})	150°C
Temperature Maximum (T_{smax})	200°C
Time (t_s) from (T_{smin} to T_{smax})	60 – 120 seconds
Ramp-up Rate (t_L to t_P)	3°C / second maximum
Liquidous Temperature (T_L)	217°C
Time (t_L) Maintained Above (T_L)	60 – 150 seconds
Peak Body Package Temperature	245°C +0°C / -5°C
Time (t_P) within 5°C of 245°C	30 seconds
Ramp-down Rate (T_P to T_L)	6°C / second maximum
Time 25°C to Peak Temperature	8 minutes maximum

ORDERING INFORMATION

Part Number	Package	Shipping†
HMHA2801	Half Pitch Mini-Flat 4-Pin	100 Units / Tube
HMHA2801R2	Half Pitch Mini-Flat 4-Pin	2500 / Tape & Reel
HMHA2801V	Half Pitch Mini-Flat 4-Pin, DIN EN/IEC60747-5-5 Option	100 Units / Tube
HMHA2801R2V	Half Pitch Mini-Flat 4-Pin, DIN EN/IEC60747-5-5 Option	2500 / Tape & Reel

†For information on tape and reel specifications, including part orientation and tape sizes, please refer to our Tape and Reel Packaging Specifications Brochure, BRD8011/D.

MECHANICAL CASE OUTLINE
PACKAGE DIMENSIONS

MFP4 2.5X4.4, 1.27P
CASE 100AL
ISSUE O

DATE 31 AUG 2016

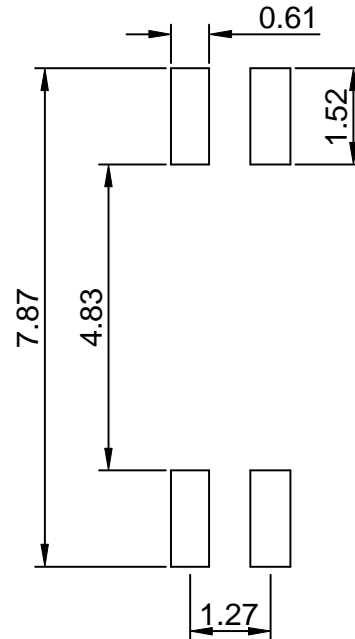
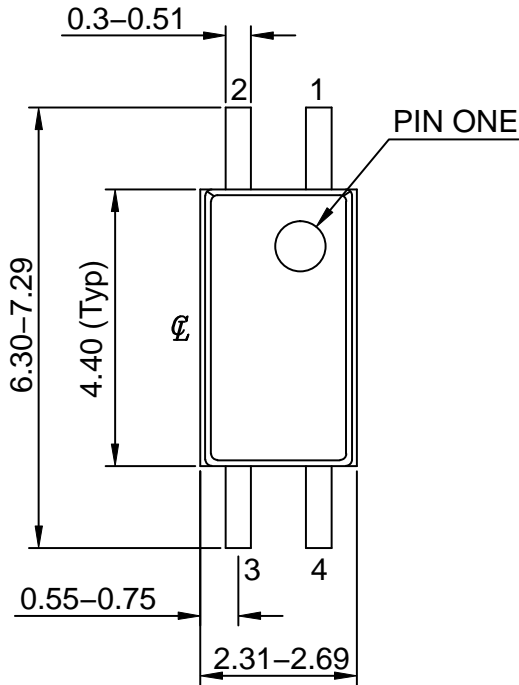

LAND PATTERN RECOMMENDATION

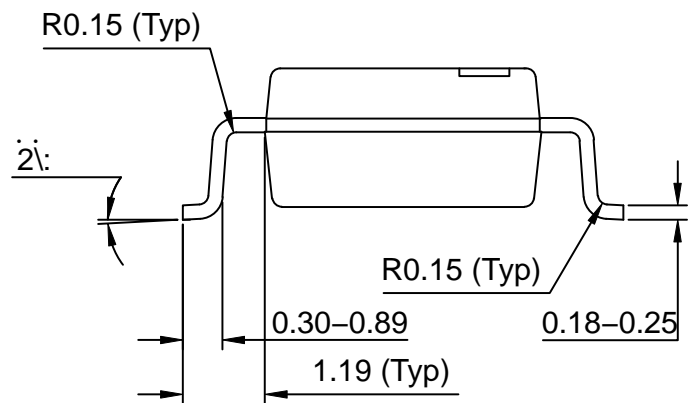
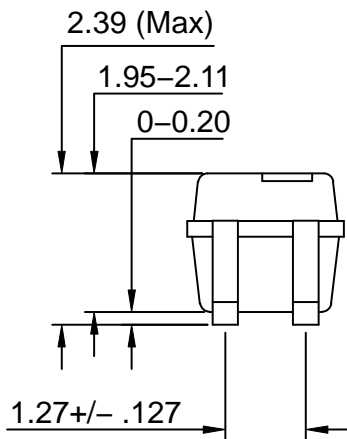

NOTES:

- A) NO STANDARD APPLIES TO THIS PACKAGE
- B) ALL DIMENSIONS ARE IN MILLIMETERS.
- C) DIMENSIONS ARE EXCLUSIVE OF BURRS, MOLD FLASH, AND TIE BAR EXTRUSION

DOCUMENT NUMBER:	98AON13485G	Electronic versions are uncontrolled except when accessed directly from the Document Repository. Printed versions are uncontrolled except when stamped "CONTROLLED COPY" in red.
STATUS:	ON SEMICONDUCTOR STANDARD	
NEW STANDARD:		
DESCRIPTION:	MFP4 2.5X4.4, 1.27P	PAGE 1 OF 2

ON Semiconductor and  are trademarks of Semiconductor Components Industries, LLC dba ON Semiconductor or its subsidiaries in the United States and/or other countries. ON Semiconductor owns the rights to a number of patents, trademarks, copyrights, trade secrets, and other intellectual property. A listing of ON Semiconductor's product/patent coverage may be accessed at www.onsemi.com/site/pdf/Patent-Marking.pdf. ON Semiconductor reserves the right to make changes without further notice to any products herein. ON Semiconductor makes no warranty, representation or guarantee regarding the suitability of its products for any particular purpose, nor does ON Semiconductor assume any liability arising out of the application or use of any product or circuit, and specifically disclaims any and all liability, including without limitation special, consequential or incidental damages. Buyer is responsible for its products and applications using ON Semiconductor products, including compliance with all laws, regulations and safety requirements or standards, regardless of any support or applications information provided by ON Semiconductor. "Typical" parameters which may be provided in ON Semiconductor data sheets and/or specifications can and do vary in different applications and actual performance may vary over time. All operating parameters, including "Typicals" must be validated for each customer application by customer's technical experts. ON Semiconductor does not convey any license under its patent rights nor the rights of others. ON Semiconductor products are not designed, intended, or authorized for use as a critical component in life support systems or any FDA Class 3 medical devices or medical devices with a same or similar classification in a foreign jurisdiction or any devices intended for implantation in the human body. Should Buyer purchase or use ON Semiconductor products for any such unintended or unauthorized application, Buyer shall indemnify and hold ON Semiconductor and its officers, employees, subsidiaries, affiliates, and distributors harmless against all claims, costs, damages, and expenses, and reasonable attorney fees arising out of, directly or indirectly, any claim of personal injury or death associated with such unintended or unauthorized use, even if such claim alleges that ON Semiconductor was negligent regarding the design or manufacture of the part. ON Semiconductor is an Equal Opportunity/Affirmative Action Employer. This literature is subject to all applicable copyright laws and is not for resale in any manner.

PUBLICATION ORDERING INFORMATION

LITERATURE FULFILLMENT:

Literature Distribution Center for ON Semiconductor
19521 E. 32nd Pkwy, Aurora, Colorado 80011 USA
Phone: 303-675-2175 or 800-344-3860 Toll Free USA/Canada
Fax: 303-675-2176 or 800-344-3867 Toll Free USA/Canada
Email: orderlit@onsemi.com

N. American Technical Support: 800-282-9855 Toll Free
USA/Canada
Europe, Middle East and Africa Technical Support:
Phone: 421 33 790 2910



ON Semiconductor Website: www.onsemi.com

Order Literature: <http://www.onsemi.com/orderlit>

For additional information, please contact your local
Sales Representative

Looking for pricing, stock, or lifecycle information?

Click below to explore more details on WIN SOURCE:

-  [View HMHA2801B on WIN SOURCE](#)
-  [Fairchild/ON Semiconductor Information](#)

Optimize Your Supply Chain with WIN SOURCE Solutions

-  Global Sourcing Solution
-  Obsolete Management
-  Cost Control Management
-  Shortage Management
-  Alternative Solution
-  Excess Inventory Management