



**THE DATASHEET OF
NS12555T100MN**



Notice for TAIYO YUDEN products

Please read this notice before using the TAIYO YUDEN products.

⚠ REMINDERS

■ Product Information in this Catalog

Product information in this catalog is as of January 2021. All of the contents specified herein and production status of the products listed in this catalog are subject to change without notice due to technical improvement of our products, etc. Therefore, please check for the latest information carefully before practical application or use of our products.

Please note that TAIYO YUDEN shall not be in any way responsible for any damages and defects in products or equipment incorporating our products, which are caused under the conditions other than those specified in this catalog or individual product specification sheets.

■ Approval of Product Specifications

Please contact TAIYO YUDEN for further details of product specifications as the individual product specification sheets are available. When using our products, please be sure to approve our product specifications or make a written agreement on the product specification with TAIYO YUDEN in advance.

■ Pre-Evaluation in the Actual Equipment and Conditions

Please conduct validation and verification of our products in actual conditions of mounting and operating environment before using our products.

■ Limited Application

1. Equipment Intended for Use

The products listed in this catalog are intended for general-purpose and standard use in general electronic equipment (e.g., AV equipment, OA equipment, home electric appliances, office equipment, information and communication equipment including, without limitation, mobile phone, and PC) and other equipment specified in this catalog or the individual product specification sheets.

TAIYO YUDEN has the line-up of the products intended for use in automotive electronic equipment, telecommunications infrastructure and industrial equipment, or medical devices classified as GHTF Classes A to C (Japan Classes I to III). Therefore, when using our products for these equipment, please check available applications specified in this catalog or the individual product specification sheets and use the corresponding products.

2. Equipment Requiring Inquiry

Please be sure to contact TAIYO YUDEN for further information before using the products listed in this catalog for the following equipment (excluding intended equipment as specified in this catalog or the individual product specification sheets) which may cause loss of human life, bodily injury, serious property damage and/or serious public impact due to a failure or defect of the products and/or malfunction attributed thereto.

- (1) Transportation equipment (automotive powertrain control system, train control system, and ship control system, etc.)
- (2) Traffic signal equipment
- (3) Disaster prevention equipment, crime prevention equipment
- (4) Medical devices classified as GHTF Class C (Japan Class III)
- (5) Highly public information network equipment, data-processing equipment (telephone exchange, and base station, etc.)
- (6) Any other equipment requiring high levels of quality and/or reliability equal to the equipment listed above

3. Equipment Prohibited for Use

Please do not incorporate our products into the following equipment requiring extremely high levels of safety and/or reliability.

- (1) Aerospace equipment (artificial satellite, rocket, etc.)
- (2) Aviation equipment *¹
- (3) Medical devices classified as GHTF Class D (Japan Class IV), implantable medical devices *²

- (4) Power generation control equipment (nuclear power, hydroelectric power, thermal power plant control system, etc.)
- (5) Undersea equipment (submarine repeating equipment, underwater work equipment, etc.)
- (6) Military equipment
- (7) Any other equipment requiring extremely high levels of safety and/or reliability equal to the equipment listed above

*Notes:

1. There is a possibility that our products can be used only for aviation equipment that does not directly affect the safe operation of aircraft (e.g., in-flight entertainment, cabin light, electric seat, cooking equipment) if such use meets requirements specified separately by TAIYO YUDEN. Please be sure to contact TAIYO YUDEN for further information before using our products for such aviation equipment.
2. Implantable medical devices contain not only internal unit which is implanted in a body, but also external unit which is connected to the internal unit.

4. Limitation of Liability

Please note that unless you obtain prior written consent of TAIYO YUDEN, TAIYO YUDEN shall not be in any way responsible for any damages incurred by you or third parties arising from use of the products listed in this catalog for any equipment that is not intended for use by TAIYO YUDEN, or any equipment requiring inquiry to TAIYO YUDEN or prohibited for use by TAIYO YUDEN as described above.

■ Safety Design

When using our products for high safety and/or reliability-required equipment or circuits, please fully perform safety and/or reliability evaluation. In addition, please install (i) systems equipped with a protection circuit and a protection device and/or (ii) systems equipped with a redundant circuit or other system to prevent an unsafe status in the event of a single fault for a failsafe design to ensure safety.

■ Intellectual Property Rights

Information contained in this catalog is intended to convey examples of typical performances and/or applications of our products and is not intended to make any warranty with respect to the intellectual property rights or any other related rights of TAIYO YUDEN or any third parties nor grant any license under such rights.

■ Limited Warranty

Please note that the scope of warranty for our products is limited to the delivered our products themselves and TAIYO YUDEN shall not be in any way responsible for any damages resulting from a failure or defect in our products. Notwithstanding the foregoing, if there is a written agreement (e.g., supply and purchase agreement, quality assurance agreement) signed by TAIYO YUDEN and your company, TAIYO YUDEN will warrant our products in accordance with such agreement.

■ TAIYO YUDEN's Official Sales Channel

The contents of this catalog are applicable to our products which are purchased from our sales offices or authorized distributors (hereinafter "TAIYO YUDEN's official sales channel"). Please note that the contents of this catalog are not applicable to our products purchased from any seller other than TAIYO YUDEN's official sales channel.

■ Caution for Export

Some of our products listed in this catalog may require specific procedures for export according to "U.S. Export Administration Regulations", "Foreign Exchange and Foreign Trade Control Law" of Japan, and other applicable regulations. Should you have any questions on this matter, please contact our sales staff.

▶ This catalog contains the typical specification only due to the limitation of space. When you consider the purchase of our products, please check our product specification sheets. For details of each product (characteristics graph, reliability information, precautions for use, and so on), see our website (<http://www.ty-top.com/>).

SMD POWER INDUCTORS (NS SERIES)

REFLOW

PARTS NUMBER

* Operating Temp.: -40~+125°C (Including self-generated heat)

| | | | | | | | | | | | | | | | |
|---|---|---|---|---|---|---|---|---------------|---|---|---|---|---|---|---|
| N | S | △ | 1 | 0 | 1 | 4 | 5 | T | △ | 1 | 0 | 0 | M | N | A |
| ① | ② | | | ③ | ④ | ⑤ | ⑥ | △=Blank space | | | | | | | |

① Series name

| Code | Series name |
|------|------------------------|
| NS△ | Shielded specification |

② Dimensions (L × W × H)

| Code | Dimensions (L × W × H) [mm] |
|-------|-----------------------------|
| 10145 | 10.1 × 10.1 × 4.5 |
| 10155 | 10.1 × 10.1 × 5.5 |
| 10165 | 10.1 × 10.1 × 6.5 |
| 12555 | 12.5 × 12.5 × 5.5 |
| 12565 | 12.5 × 12.5 × 6.5 |
| 12575 | 12.5 × 12.5 × 7.5 |

③ Packaging

| Code | Packaging |
|------|-----------|
| T△ | Taping |

④ Nominal inductance

| Code (example) | Nominal inductance [μH] |
|----------------|-------------------------|
| 1R0 | 1.0 |
| 100 | 10 |
| 101 | 100 |

※R=Decimal point

⑤ Inductance tolerance

| Code | Inductance tolerance |
|------|----------------------|
| M | ±20% |
| N | ±30% |

⑥ Internal code

| Code | Internal code |
|------|---------------|
| N△ | Internal code |
| NA | |

STANDARD EXTERNAL DIMENSIONS / MINIMUM QUANTITY

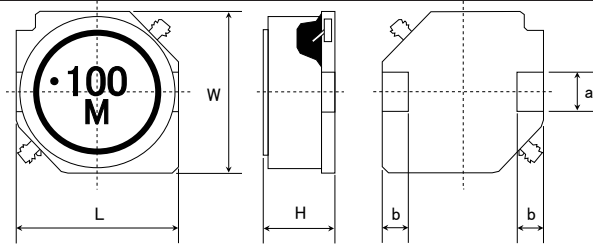

※ The NS 101□□ type does not have the indication of the Manufacturing date code.

| Type | L | W | H | a | b | Minimum quantity [pcs] |
|----------|---------------------------|---------------------------|---------------------------|--------------------------|---------------------------|------------------------|
| NS 10145 | 10.1±0.3 (0.398±0.012) | 10.1±0.3 (0.398±0.012) | 4.5±0.35 (0.177±0.014) | 2.8±0.1 (0.110±0.004) | 2.0±0.15 (0.079±0.006) | 2000 |
| NS 10155 | 10.1±0.3 (0.398±0.012) | 10.1±0.3 (0.398±0.012) | 5.5±0.35 (0.217±0.014) | 2.8±0.1 (0.110±0.004) | 2.0±0.15 (0.079±0.006) | 2000 |
| NS 10165 | 10.1±0.3 (0.398±0.012) | 10.1±0.3 (0.398±0.012) | 6.5±0.35 (0.256±0.014) | 2.8±0.1 (0.110±0.004) | 2.0±0.15 (0.079±0.006) | 2000 |
| NS 12555 | 12.5±0.3 (0.492±0.012) | 12.5±0.3 (0.492±0.012) | 5.5±0.35 (0.217±0.014) | 3.0±0.1 (0.118±0.004) | 2.0±0.15 (0.079±0.006) | 2000 |
| NS 12565 | 12.5±0.3 (0.492±0.012) | 12.5±0.3 (0.492±0.012) | 6.5±0.35 (0.256±0.014) | 3.0±0.1 (0.118±0.004) | 2.0±0.15 (0.079±0.006) | 2000 |
| NS 12575 | 12.5±0.3 (0.492±0.012) | 12.5±0.3 (0.492±0.012) | 7.5±0.35 (0.295±0.014) | 3.0±0.1 (0.118±0.004) | 2.0±0.15 (0.079±0.006) | 2000 |

Unit: mm (inch)

Recommended Land Patterns

Surface Mounting

- Mounting and soldering conditions should be checked beforehand.
- Applicable soldering process to these products is reflow soldering only.

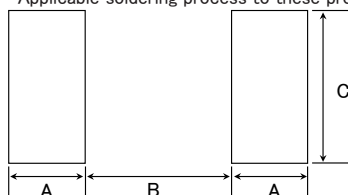

| Type | A | B | C |
|----------|-----|-----|-----|
| NS 10145 | 2.5 | 5.6 | 3.2 |
| NS 10155 | 2.5 | 5.6 | 3.2 |
| NS 10165 | 2.5 | 5.6 | 3.2 |
| NS 12555 | 2.5 | 8.6 | 3.2 |
| NS 12565 | 2.5 | 8.6 | 3.2 |
| NS 12575 | 2.5 | 8.6 | 3.2 |

Unit: mm

▶ This catalog contains the typical specification only due to the limitation of space. When you consider the purchase of our products, please check our product specification sheets. For details of each product (characteristics graph, reliability information, precautions for use, and so on), see our website (<http://www.ty-top.com/>).

PARTS NUMBER

● NS 10145 type

| Parts number | EHS | Nominal inductance [μ H] | Inductance tolerance | DC Resistance [Ω] ($\pm 20\%$) | Rated current ※) [A] | | Measuring frequency [kHz] |
|------------------|------|----------------------------------|----------------------|--|----------------------------|----------------------------------|------------------------------|
| | | | | | Saturation current Idc1 | Temperature rise current Idc2 | |
| NS 10145T 1R0NNA | RoHS | 1.0 | $\pm 30\%$ | 0.0049 | 12.54 | 8.90 | 100 |
| NS 10145T 1R5NNA | RoHS | 1.5 | $\pm 30\%$ | 0.0060 | 10.34 | 7.99 | 100 |
| NS 10145T 2R2NNA | RoHS | 2.2 | $\pm 30\%$ | 0.0085 | 8.91 | 6.64 | 100 |
| NS 10145T 3R3NNA | RoHS | 3.3 | $\pm 30\%$ | 0.0100 | 7.33 | 6.10 | 100 |
| NS 10145T 4R7NNA | RoHS | 4.7 | $\pm 30\%$ | 0.0144 | 6.69 | 5.03 | 100 |
| NS 10145T 5R6NNA | RoHS | 5.6 | $\pm 30\%$ | 0.0181 | 5.85 | 4.45 | 100 |
| NS 10145T 6R8NNA | RoHS | 6.8 | $\pm 30\%$ | 0.0200 | 5.05 | 4.22 | 100 |
| NS 10145T 100MNA | RoHS | 10 | $\pm 20\%$ | 0.0248 | 4.22 | 3.77 | 100 |
| NS 10145T 150MNA | RoHS | 15 | $\pm 20\%$ | 0.0381 | 3.44 | 3.00 | 100 |
| NS 10145T 220MNA | RoHS | 22 | $\pm 20\%$ | 0.0520 | 2.87 | 2.55 | 100 |
| NS 10145T 330MNA | RoHS | 33 | $\pm 20\%$ | 0.0815 | 2.36 | 2.01 | 100 |
| NS 10145T 470MNA | RoHS | 47 | $\pm 20\%$ | 0.100 | 1.85 | 1.80 | 100 |
| NS 10145T 680MNA | RoHS | 68 | $\pm 20\%$ | 0.150 | 1.66 | 1.45 | 100 |
| NS 10145T 101MNA | RoHS | 100 | $\pm 20\%$ | 0.200 | 1.29 | 1.25 | 100 |
| NS 10145T 151MNA | RoHS | 150 | $\pm 20\%$ | 0.341 | 1.11 | 0.94 | 100 |
| NS 10145T 221MNA | RoHS | 220 | $\pm 20\%$ | 0.485 | 0.91 | 0.78 | 100 |
| NS 10145T 331MNA | RoHS | 330 | $\pm 20\%$ | 0.700 | 0.71 | 0.64 | 100 |
| NS 10145T 471MNA | RoHS | 470 | $\pm 20\%$ | 1.030 | 0.61 | 0.52 | 100 |
| NS 10145T 681MNA | RoHS | 680 | $\pm 20\%$ | 1.57 | 0.50 | 0.42 | 100 |
| NS 10145T 102MNA | RoHS | 1000 | $\pm 20\%$ | 2.58 | 0.41 | 0.32 | 100 |
| NS 10145T 152MNA | RoHS | 1500 | $\pm 20\%$ | 3.70 | 0.36 | 0.27 | 100 |

● NS 10155 type

| Parts number | EHS | Nominal inductance [μ H] | Inductance tolerance | DC Resistance [Ω] ($\pm 20\%$) | Rated current ※) [A] | | Measuring frequency [kHz] |
|------------------|------|----------------------------------|----------------------|--|----------------------------|----------------------------------|------------------------------|
| | | | | | Saturation current Idc1 | Temperature rise current Idc2 | |
| NS 10155T 1R5NNA | RoHS | 1.5 | $\pm 30\%$ | 0.0060 | 11.90 | 8.39 | 100 |
| NS 10155T 2R2NNA | RoHS | 2.2 | $\pm 30\%$ | 0.0072 | 10.00 | 7.61 | 100 |
| NS 10155T 3R3NNA | RoHS | 3.3 | $\pm 30\%$ | 0.0097 | 8.50 | 6.49 | 100 |
| NS 10155T 4R7NNA | RoHS | 4.7 | $\pm 30\%$ | 0.0112 | 7.40 | 6.01 | 100 |
| NS 10155T 6R8NNA | RoHS | 6.8 | $\pm 30\%$ | 0.0159 | 6.00 | 4.98 | 100 |
| NS 10155T 100MNA | RoHS | 10 | $\pm 20\%$ | 0.0200 | 4.49 | 4.40 | 100 |
| NS 10155T 150MNA | RoHS | 15 | $\pm 20\%$ | 0.0284 | 4.03 | 3.65 | 100 |
| NS 10155T 220MNA | RoHS | 22 | $\pm 20\%$ | 0.0380 | 3.37 | 3.12 | 100 |

● NS 10165 type

| Parts number | EHS | Nominal inductance [μ H] | Inductance tolerance | DC Resistance [Ω] ($\pm 20\%$) | Rated current ※) [A] | | Measuring frequency [kHz] |
|------------------|------|----------------------------------|----------------------|--|----------------------------|----------------------------------|------------------------------|
| | | | | | Saturation current Idc1 | Temperature rise current Idc2 | |
| NS 10165T 1R5NNA | RoHS | 1.5 | $\pm 30\%$ | 0.0062 | 13.60 | 8.04 | 100 |
| NS 10165T 2R2NNA | RoHS | 2.2 | $\pm 30\%$ | 0.0074 | 10.80 | 7.32 | 100 |
| NS 10165T 3R3NNA | RoHS | 3.3 | $\pm 30\%$ | 0.0086 | 9.30 | 6.76 | 100 |
| NS 10165T 4R7NNA | RoHS | 4.7 | $\pm 30\%$ | 0.0112 | 7.70 | 5.88 | 100 |
| NS 10165T 6R8NNA | RoHS | 6.8 | $\pm 30\%$ | 0.0140 | 6.00 | 5.22 | 100 |
| NS 10165T 100MNA | RoHS | 10 | $\pm 20\%$ | 0.0174 | 5.20 | 4.66 | 100 |
| NS 10165T 150MNA | RoHS | 15 | $\pm 20\%$ | 0.0250 | 4.50 | 3.84 | 100 |
| NS 10165T 220MNA | RoHS | 22 | $\pm 20\%$ | 0.0313 | 3.60 | 3.41 | 100 |

● NS 12555 type

| Parts number | EHS | Nominal inductance [μ H] | Inductance tolerance | DC Resistance [Ω] ($\pm 20\%$) | Rated current ※) [A] | | Measuring frequency [kHz] |
|-----------------|------|----------------------------------|----------------------|--|----------------------------|----------------------------------|------------------------------|
| | | | | | Saturation current Idc1 | Temperature rise current Idc2 | |
| NS 12555T 6R0NN | RoHS | 6.0 | $\pm 30\%$ | 0.0140 | 5.01 | 5.60 | 100 |
| NS 12555T 100MN | RoHS | 10 | $\pm 20\%$ | 0.0175 | 4.73 | 5.04 | 100 |
| NS 12555T 150MN | RoHS | 15 | $\pm 20\%$ | 0.0233 | 3.89 | 4.18 | 100 |
| NS 12555T 220MN | RoHS | 22 | $\pm 20\%$ | 0.0297 | 3.20 | 3.81 | 100 |
| NS 12555T 330MN | RoHS | 33 | $\pm 20\%$ | 0.0415 | 2.64 | 3.16 | 100 |
| NS 12555T 470MN | RoHS | 47 | $\pm 20\%$ | 0.0551 | 2.23 | 2.70 | 100 |
| NS 12555T 680MN | RoHS | 68 | $\pm 20\%$ | 0.0797 | 1.81 | 2.14 | 100 |
| NS 12555T 101MN | RoHS | 100 | $\pm 20\%$ | 0.117 | 1.53 | 1.86 | 100 |
| NS 12555T 151MN | RoHS | 150 | $\pm 20\%$ | 0.176 | 1.22 | 1.43 | 100 |
| NS 12555T 221MN | RoHS | 220 | $\pm 20\%$ | 0.270 | 1.00 | 1.18 | 100 |
| NS 12555T 331MN | RoHS | 330 | $\pm 20\%$ | 0.410 | 0.82 | 0.96 | 100 |
| NS 12555T 471MN | RoHS | 470 | $\pm 20\%$ | 0.520 | 0.68 | 0.80 | 100 |
| NS 12555T 681MN | RoHS | 680 | $\pm 20\%$ | 0.760 | 0.60 | 0.72 | 100 |
| NS 12555T 102MN | RoHS | 1000 | $\pm 20\%$ | 1.12 | 0.47 | 0.59 | 100 |
| NS 12555T 152MN | RoHS | 1500 | $\pm 20\%$ | 1.73 | 0.40 | 0.44 | 100 |

※) The saturation current value (Idc1) is the DC current value having inductance decrease down to 30%. (at 20°C)

※) The temperature rise current value (Idc2) is the DC current value having temperature increase up to 40°C. (at 20°C)

※) The rated current is the DC current value that satisfies both of current value saturation current value and temperature rise current value.

PARTS NUMBER

● NS 12565 type

| Parts number | EHS | Nominal inductance [μ H] | Inductance tolerance | DC Resistance [Ω] ($\pm 20\%$) | Rated current ※) [A] | | Measuring frequency [kHz] |
|-----------------|------|----------------------------------|----------------------|--|----------------------------|----------------------------------|------------------------------|
| | | | | | Saturation current Idc1 | Temperature rise current Idc2 | |
| NS 12565T 2R0NN | RoHS | 2.0 | $\pm 30\%$ | 0.0080 | 13.91 | 7.60 | 100 |
| NS 12565T 4R2NN | RoHS | 4.2 | $\pm 30\%$ | 0.0126 | 10.15 | 5.91 | 100 |
| NS 12565T 7R0NN | RoHS | 7.0 | $\pm 30\%$ | 0.0162 | 7.93 | 5.21 | 100 |
| NS 12565T 100MN | RoHS | 10 | $\pm 20\%$ | 0.0199 | 6.96 | 4.75 | 100 |
| NS 12565T 150MN | RoHS | 15 | $\pm 20\%$ | 0.0237 | 5.84 | 4.33 | 100 |
| NS 12565T 220MN | RoHS | 22 | $\pm 20\%$ | 0.0310 | 4.87 | 3.91 | 100 |
| NS 12565T 330MN | RoHS | 33 | $\pm 20\%$ | 0.0390 | 3.89 | 3.22 | 100 |
| NS 12565T 470MN | RoHS | 47 | $\pm 20\%$ | 0.0575 | 3.34 | 2.78 | 100 |
| NS 12565T 680MN | RoHS | 68 | $\pm 20\%$ | 0.0775 | 2.78 | 2.30 | 100 |
| NS 12565T 101MN | RoHS | 100 | $\pm 20\%$ | 0.123 | 2.23 | 1.81 | 100 |
| NS 12565T 151MN | RoHS | 150 | $\pm 20\%$ | 0.173 | 1.84 | 1.54 | 100 |
| NS 12565T 221MN | RoHS | 220 | $\pm 20\%$ | 0.273 | 1.39 | 1.18 | 100 |

● NS 12575 type

| Parts number | EHS | Nominal inductance [μ H] | Inductance tolerance | DC Resistance [Ω] ($\pm 20\%$) | Rated current ※) [A] | | Measuring frequency [kHz] |
|-----------------|------|----------------------------------|----------------------|--|----------------------------|----------------------------------|------------------------------|
| | | | | | Saturation current Idc1 | Temperature rise current Idc2 | |
| NS 12575T 1R2NN | RoHS | 1.2 | $\pm 30\%$ | 0.0058 | 18.08 | 9.15 | 100 |
| NS 12575T 2R7NN | RoHS | 2.7 | $\pm 30\%$ | 0.0085 | 13.91 | 7.69 | 100 |
| NS 12575T 3R9NN | RoHS | 3.9 | $\pm 30\%$ | 0.0099 | 12.52 | 7.38 | 100 |
| NS 12575T 5R6NN | RoHS | 5.6 | $\pm 30\%$ | 0.0116 | 10.85 | 6.36 | 100 |
| NS 12575T 6R8NN | RoHS | 6.8 | $\pm 30\%$ | 0.0131 | 10.02 | 5.84 | 100 |
| NS 12575T 100MN | RoHS | 10 | $\pm 20\%$ | 0.0156 | 7.65 | 5.55 | 100 |
| NS 12575T 150MN | RoHS | 15 | $\pm 20\%$ | 0.0184 | 6.54 | 5.22 | 100 |
| NS 12575T 220MN | RoHS | 22 | $\pm 20\%$ | 0.0260 | 5.56 | 4.05 | 100 |
| NS 12575T 330MN | RoHS | 33 | $\pm 20\%$ | 0.0390 | 4.45 | 3.48 | 100 |
| NS 12575T 470MN | RoHS | 47 | $\pm 20\%$ | 0.0515 | 3.76 | 2.95 | 100 |
| NS 12575T 680MN | RoHS | 68 | $\pm 20\%$ | 0.0720 | 2.78 | 2.49 | 100 |
| NS 12575T 101MN | RoHS | 100 | $\pm 20\%$ | 0.110 | 2.64 | 2.01 | 100 |
| NS 12575T 151MN | RoHS | 150 | $\pm 20\%$ | 0.161 | 2.09 | 1.51 | 100 |
| NS 12575T 221MN | RoHS | 220 | $\pm 20\%$ | 0.245 | 1.81 | 1.35 | 100 |

※) The saturation current value (Idc1) is the DC current value having inductance decrease down to 30%. (at 20°C)

※) The temperature rise current value (Idc2) is the DC current value having temperature increase up to 40°C. (at 20°C)

※) The rated current is the DC current value that satisfies both of current value saturation current value and temperature rise current value.

► This catalog contains the typical specification only due to the limitation of space. When you consider the purchase of our products, please check our product specification sheets. For details of each product (characteristics graph, reliability information, precautions for use, and so on), see our website (<http://www.ty-top.com/>).

SMD POWER INDUCTORS (NS SERIES)

PACKAGING

① Packing Quantity

| Type | Standard Quantity (1reel) [pcs] | Minimum Quantity [pcs] |
|---------|---------------------------------|------------------------|
| | Embossed Tape | Embossed Tape |
| NS10145 | 500 | 2000 |
| NS10155 | 500 | 2000 |
| NS10165 | 500 | 2000 |
| NS12555 | 500 | 2000 |
| NS12565 | 500 | 2000 |
| NS12575 | 500 | 2000 |

② Tape Material

● Embossed Tape

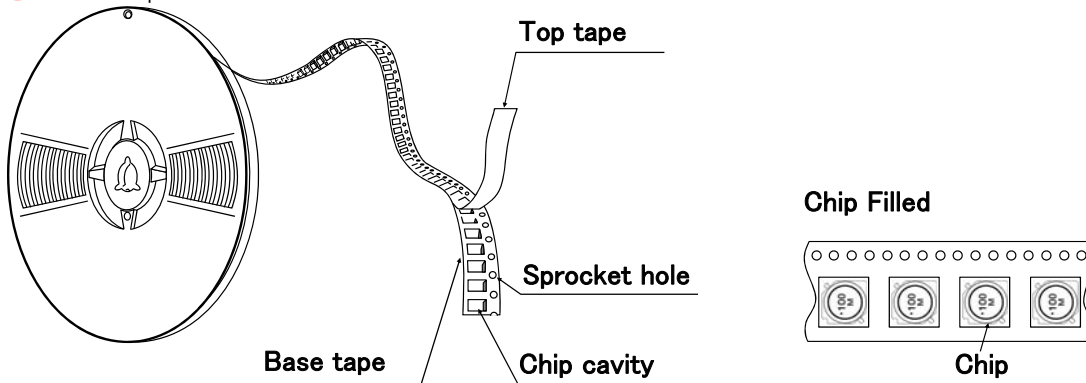

③ Taping dimensions

● Embossed tape 24mm wide (0.945 inches wide)

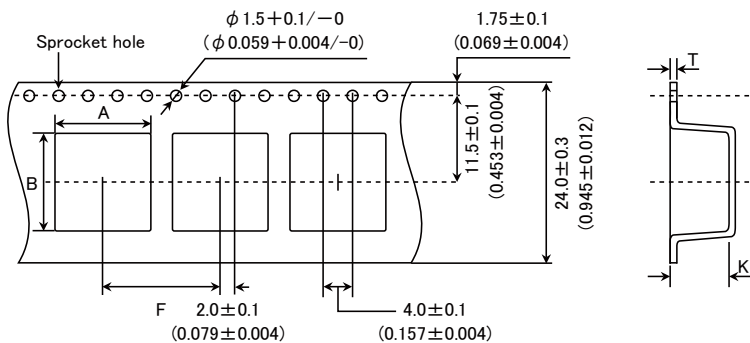

| Type | Chip cavity | | Insertion pitch | Tape thickness | |
|---------|---|---|---|--|--|
| | A | B | F | T | K |
| NS10145 | 10.5 ± 0.1 (0.413 ± 0.004) | 10.5 ± 0.1 (0.413 ± 0.004) | 16.0 ± 0.1 (0.630 ± 0.004) | 0.4 ± 0.1 (0.016 ± 0.004) | 5.0 ± 0.1 (0.197 ± 0.004) |
| NS10155 | 10.5 ± 0.1 (0.413 ± 0.004) | 10.5 ± 0.1 (0.413 ± 0.004) | 16.0 ± 0.1 (0.630 ± 0.004) | 0.4 ± 0.1 (0.016 ± 0.004) | 6.0 ± 0.1 (0.236 ± 0.004) |
| NS10165 | 10.5 ± 0.1 (0.413 ± 0.004) | 10.5 ± 0.1 (0.413 ± 0.004) | 16.0 ± 0.1 (0.630 ± 0.004) | 0.4 ± 0.1 (0.016 ± 0.004) | 7.0 ± 0.1 (0.276 ± 0.004) |
| NS12555 | 13.0 ± 0.1 (0.512 ± 0.004) | 13.0 ± 0.1 (0.512 ± 0.004) | 16.0 ± 0.1 (0.630 ± 0.004) | 0.4 ± 0.1 (0.016 ± 0.004) | 6.1 ± 0.1 (0.240 ± 0.004) |
| NS12565 | 13.0 ± 0.1 (0.512 ± 0.004) | 13.0 ± 0.1 (0.512 ± 0.004) | 16.0 ± 0.1 (0.630 ± 0.004) | 0.4 ± 0.1 (0.016 ± 0.004) | 7.1 ± 0.1 (0.280 ± 0.004) |
| NS12575 | 13.0 ± 0.1 (0.512 ± 0.004) | 13.0 ± 0.1 (0.512 ± 0.004) | 16.0 ± 0.1 (0.630 ± 0.004) | 0.4 ± 0.1 (0.016 ± 0.004) | 8.0 ± 0.1 (0.315 ± 0.004) |

Unit : mm (inch)

▶ This catalog contains the typical specification only due to the limitation of space. When you consider the purchase of our products, please check our specification. For details of each product (characteristics graph, reliability information, precautions for use, and so on), see our Web site (<http://www.ty-top.com/>).

④ Leader and Blank portion

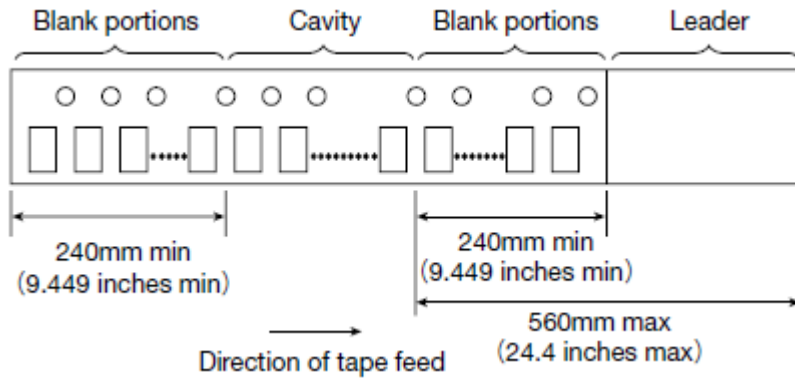

⑤ Reel size

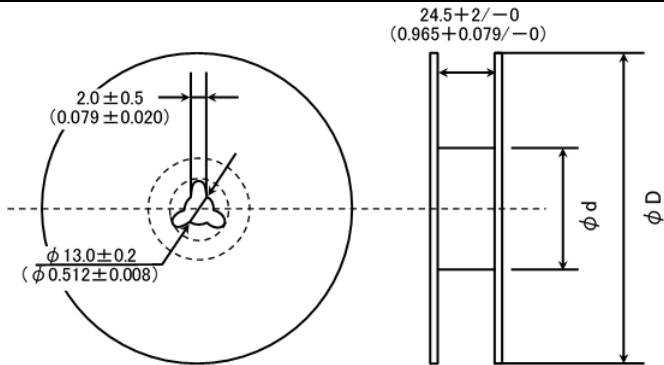

| Type | Reel size (Reference values) | |
|---------|------------------------------|----------------------------|
| | ϕD | ϕd |
| NS10145 | 330 ± 2 (12.99 ± 0.079) | 100 ± 1 (3.937 ± 0.039) |
| NS10155 | | |
| NS10165 | | |
| NS12555 | | |
| NS12565 | | |
| NS12575 | | |

Unit: mm (inch)

⑥ Top Tape Strength

The top tape requires a peel-off force of 0.1 to 1.3N in the direction of the arrow as illustrated below.

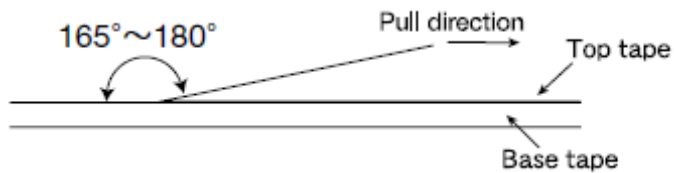

SMD POWER INDUCTORS (NR□, NS SERIES)

RELIABILITY DATA

| 1. Operating Temperature Range | | |
|--------------------------------|---|--------------------------------|
| Specified Value | NR30/40/50/60/80, NRS20, NRV20/30, NRH24/30 Type | -25~+120°C |
| | NRS40/50/60/80 Type | -25~+125°C |
| | NR10050 Type | -25~+105°C |
| | NS101, NS125 Type | -40~+125°C |
| Test Methods and Remarks | Including self-generated heat | |
| 2. Storage Temperature Range | | |
| Specified Value | NR30/40/50/60/80, NRV20/30, NRH24/30, NRS20/40/50/60/80 Type | -40~+85°C |
| | NR10050 Type | |
| | NS101, NS125 Type | |
| Test Methods and Remarks | NR30/40/50/60/80, NRV20/30, NRH24/30, NRS20/40/50/60/80 Type, NR10050 Type, NS101/125 Type : -5 to 40°C for the product with taping. | |
| 3. Rated current | | |
| Specified Value | NR30/40/50/60/80, NRV20/30, NRH24/30, NRS20/40/50/60/80 Type | Within the specified tolerance |
| | NR10050 Type | |
| | NS101, NS125 Type | |
| 4. Inductance | | |
| Specified Value | NR30/40/50/60/80, NRV20/30, NRH24/30, NRS20/40/50/60/80 Type | Within the specified tolerance |
| | NR10050 Type | |
| | NS101, NS125 Type | |
| Test Methods and Remarks | Measuring equipment : LCR Meter (HP 4285A or equivalent) Measuring frequency : Specified frequency NR30/40/50/60/80, NRV20/30, NRH24/30, NRS20/40/50/60/80 Type, NR10050 Type, NS101/125 Type : Measuring equipment : LCR Meter (HP 4285A or equivalent) Measuring frequency : 100kHz, 1V NR10050 Type : Measuring equipment : LCR Meter (HP 4263A or equivalent) Measuring frequency : 100kHz, 1V | |
| 5. DC Resistance | | |
| Specified Value | NR30/40/50/60/80, NRV20/30, NRH24/30, NRS20/40/50/60/80 Type | Within the specified tolerance |
| | NR10050 Type | |
| | NS101, NS125 Type | |
| Test Methods and Remarks | Measuring equipment : DC ohmmeter (HIOKI 3227 or equivalent) | |
| 6. Self resonance frequency | | |
| Specified Value | NR30/40/50/60/80, NRV30, NRH24/30, NRS40/50/60/80 Type | Within the specified tolerance |
| | NR10050 Type | |
| | NS101, NS125 Type | - |
| Test Methods and Remarks | NR30/40/50/60/80, NRV30, NRH24/30, NRS40/50/60/80 Type, NR10050 Type : Measuring equipment : Impedance analyzer/material analyzer (HP4291A or equivalent HP4191A, 4192A or equivalent) | |

▶ This catalog contains the typical specification only due to the limitation of space. When you consider the purchase of our products, please check our specification. For details of each product (characteristics graph, reliability information, precautions for use, and so on), see our Web site (<http://www.ty-top.com/>).

| 7. Temperature characteristic | | | | | | | | | | | | | | |
|-------------------------------|--|---------------------------------------|------------------------------------|---|----|---|-------------------------------|---|---------------------------|---|-------------------------------|---|----|--|
| Specified Value | NR30/40/50/60/80, NRV20/30, NRH24/30, NRS20/40/50/60/80 Type | Inductance change : Within $\pm 20\%$ | | | | | | | | | | | | |
| | NR10050 Type | | | | | | | | | | | | | |
| | NS101, NS125 Type | Inductance change : Within $\pm 15\%$ | | | | | | | | | | | | |
| Test Methods and Remarks | NR30/40/50/60/80, NRV20/30, NRH24/30, NRS20/40/50/60/80 Type, NR10050 Type : Measurement of inductance shall be taken at temperature range within $-25^{\circ}\text{C}\sim +85^{\circ}\text{C}$. With reference to inductance value at $+20^{\circ}\text{C}$., change rate shall be calculated. | | | | | | | | | | | | | |
| | NS101, NS125 Type : Measurement of inductance shall be taken at temperature range within $-40^{\circ}\text{C}\sim +125^{\circ}\text{C}$. With reference to inductance value at $+20^{\circ}\text{C}$., change rate shall be calculated. Change of maximum inductance deviation in step 1 to 5 | | | | | | | | | | | | | |
| | <table border="1"> <thead> <tr> <th>Step</th> <th>Temperature ($^{\circ}\text{C}$)</th> </tr> </thead> <tbody> <tr> <td>1</td> <td>20</td> </tr> <tr> <td>2</td> <td>Minimum operating temperature</td> </tr> <tr> <td>3</td> <td>20 (Standard temperature)</td> </tr> <tr> <td>4</td> <td>Maximum operating temperature</td> </tr> <tr> <td>5</td> <td>20</td> </tr> </tbody> </table> | Step | Temperature ($^{\circ}\text{C}$) | 1 | 20 | 2 | Minimum operating temperature | 3 | 20 (Standard temperature) | 4 | Maximum operating temperature | 5 | 20 | |
| Step | Temperature ($^{\circ}\text{C}$) | | | | | | | | | | | | | |
| 1 | 20 | | | | | | | | | | | | | |
| 2 | Minimum operating temperature | | | | | | | | | | | | | |
| 3 | 20 (Standard temperature) | | | | | | | | | | | | | |
| 4 | Maximum operating temperature | | | | | | | | | | | | | |
| 5 | 20 | | | | | | | | | | | | | |

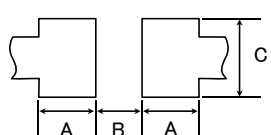
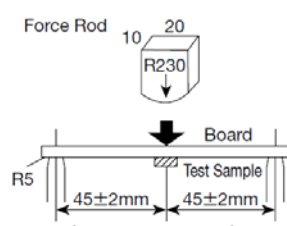
| 8. Resistance to flexure of substrate | | | | | | | | | | | | | | | | | | | | | | | | | | | | | | | | | | | | | | | | | | | | |
|---------------------------------------|---|-----------|-----|---|---|--------------|------|-----|-----|-------|-----|------|-----|--------------------|-----|-----|-----|-------------|-----|-----|-----|-------------|-----|-----|-----|-------------|-----|-----|-----|-------------|-----|-----|-----|------|---|---|---|-------|-----|-----|-----|-------|-----|-----|
| Specified Value | NR30/40/50/60/80, NRV20/30, NRH24/30, NRS20/40/50/60/80 Type | No damage | | | | | | | | | | | | | | | | | | | | | | | | | | | | | | | | | | | | | | | | | | |
| | NR10050 Type | — | | | | | | | | | | | | | | | | | | | | | | | | | | | | | | | | | | | | | | | | | | |
| | NS101, NS125 Type | No damage | | | | | | | | | | | | | | | | | | | | | | | | | | | | | | | | | | | | | | | | | | |
| Test Methods and Remarks | NR30/40/50/60/80, NRV20/30, NRH24/30, NRS20/40/50/60/80 Type, NS101/125 Type : The test samples shall be soldered to the test board by the reflow. As illustrated below, apply force in the direction of the arrow indicating until deflection of the test board reaches to 2 mm. Test board size : $100 \times 40 \times 1.0$ Test board material : Glass epoxy-resin Solder cream thickness : 0.10mm (NR30, NRS20, NRH24/30, NRV20/30) : 0.15mm (NR40/50/60/80, NRS40/50/60, NS101/125Type) | | | | | | | | | | | | | | | | | | | | | | | | | | | | | | | | | | | | | | | | | | | |
| | <div style="display: flex; align-items: flex-start;"> <div style="margin-right: 20px;"> <p>Land dimension</p>  </div> <table border="1"> <thead> <tr> <th>Type</th> <th>A</th> <th>B</th> <th>C</th> </tr> </thead> <tbody> <tr> <td>NRS20, NRV20</td> <td>0.65</td> <td>0.7</td> <td>2.0</td> </tr> <tr> <td>NRH24</td> <td>0.7</td> <td>0.75</td> <td>2.0</td> </tr> <tr> <td>NR30, NRV30, NRH30</td> <td>0.8</td> <td>1.4</td> <td>2.7</td> </tr> <tr> <td>NR40, NRS40</td> <td>1.2</td> <td>1.6</td> <td>3.7</td> </tr> <tr> <td>NR50, NRS50</td> <td>1.5</td> <td>2.1</td> <td>4.0</td> </tr> <tr> <td>NR60, NRS60</td> <td>1.6</td> <td>3.1</td> <td>5.7</td> </tr> <tr> <td>NR80, NRS80</td> <td>1.8</td> <td>3.8</td> <td>7.5</td> </tr> </tbody> </table> </div> <div style="margin-left: 20px;">  <table border="1"> <thead> <tr> <th>Type</th> <th>A</th> <th>B</th> <th>C</th> </tr> </thead> <tbody> <tr> <td>NS101</td> <td>2.5</td> <td>5.6</td> <td>3.2</td> </tr> <tr> <td>NS125</td> <td>2.5</td> <td>8.6</td> <td>3.2</td> </tr> </tbody> </table> </div> | Type | A | B | C | NRS20, NRV20 | 0.65 | 0.7 | 2.0 | NRH24 | 0.7 | 0.75 | 2.0 | NR30, NRV30, NRH30 | 0.8 | 1.4 | 2.7 | NR40, NRS40 | 1.2 | 1.6 | 3.7 | NR50, NRS50 | 1.5 | 2.1 | 4.0 | NR60, NRS60 | 1.6 | 3.1 | 5.7 | NR80, NRS80 | 1.8 | 3.8 | 7.5 | Type | A | B | C | NS101 | 2.5 | 5.6 | 3.2 | NS125 | 2.5 | 8.6 |
| Type | A | B | C | | | | | | | | | | | | | | | | | | | | | | | | | | | | | | | | | | | | | | | | | |
| NRS20, NRV20 | 0.65 | 0.7 | 2.0 | | | | | | | | | | | | | | | | | | | | | | | | | | | | | | | | | | | | | | | | | |
| NRH24 | 0.7 | 0.75 | 2.0 | | | | | | | | | | | | | | | | | | | | | | | | | | | | | | | | | | | | | | | | | |
| NR30, NRV30, NRH30 | 0.8 | 1.4 | 2.7 | | | | | | | | | | | | | | | | | | | | | | | | | | | | | | | | | | | | | | | | | |
| NR40, NRS40 | 1.2 | 1.6 | 3.7 | | | | | | | | | | | | | | | | | | | | | | | | | | | | | | | | | | | | | | | | | |
| NR50, NRS50 | 1.5 | 2.1 | 4.0 | | | | | | | | | | | | | | | | | | | | | | | | | | | | | | | | | | | | | | | | | |
| NR60, NRS60 | 1.6 | 3.1 | 5.7 | | | | | | | | | | | | | | | | | | | | | | | | | | | | | | | | | | | | | | | | | |
| NR80, NRS80 | 1.8 | 3.8 | 7.5 | | | | | | | | | | | | | | | | | | | | | | | | | | | | | | | | | | | | | | | | | |
| Type | A | B | C | | | | | | | | | | | | | | | | | | | | | | | | | | | | | | | | | | | | | | | | | |
| NS101 | 2.5 | 5.6 | 3.2 | | | | | | | | | | | | | | | | | | | | | | | | | | | | | | | | | | | | | | | | | |
| NS125 | 2.5 | 8.6 | 3.2 | | | | | | | | | | | | | | | | | | | | | | | | | | | | | | | | | | | | | | | | | |

| 9. Insulation resistance : between wires | | |
|--|---|---|
| Specified Value | NR30/40/50/60/80, NRV20/30, NRH24/30, NRS20/40/50/60/80 Type | — |
| | NR10050 Type | |
| | NS101, NS125 Type | |

| 10. Insulation resistance : between wire and core | | |
|---|---|---|
| Specified Value | NR30/40/50/60/80, NRV20/30, NRH24/30, NRS20/40/50/60/80 Type | — |
| | NR10050 Type | |
| | NS101, NS125 Type | |

▶ This catalog contains the typical specification only due to the limitation of space. When you consider the purchase of our products, please check our specification.
For details of each product (characteristics graph, reliability information, precautions for use, and so on), see our Web site (<http://www.ty-top.com/>).

| 15. Resistance to soldering heat | | |
|----------------------------------|--|--|
| Specified Value | NR30/40/50/60/80, NRV20/30, NRH24/30, NRS20/40/50/60/80 Type | Inductance change : Within $\pm 10\%$ No significant abnormality in appearance. |
| | NR10050 Type | |
| | NS101, NS125 Type | |
| Test Methods and Remarks | NR30/40/50/60/80, NRV20/30, NRH24/30, NRS20/40/50/60/80 Type, NR10050 Type, NS101/125 Type : The test sample shall be exposed to reflow oven at $230\pm 5^{\circ}\text{C}$ for 40 seconds, with peak temperature at $260\pm 5^{\circ}\text{C}$ for 5 seconds, 2 times. NR30/40/50/60/80, NRV20/30, NRH24/30, NRS20/40/50/60/80 Type, NS101/125 Type Test board material : Glass epoxy-resin Test board thickness : 1.0mm NR10050 Type Test board material : Glass epoxy-resin Test board thickness : 1.6mm Recovery : At least 2hrs of recovery under the standard condition after the test, followed by the measurement within 48hrs. | |

| 16. Thermal shock | | | | | | | | | | | | | | | | | | | | |
|--------------------------|--|--|-----------------------|--|--|------|------------------------------------|----------------|---|------------|-----------|---|------------------|----------|---|------------|-----------|---|------------------|----------|
| Specified Value | NR30/40/50/60/80, NRV20/30, NRH24/30, NRS20/40/50/60/80 Type | Inductance change : Within $\pm 10\%$ No significant abnormality in appearance. | | | | | | | | | | | | | | | | | | |
| | NR10050 Type | | | | | | | | | | | | | | | | | | | |
| | NS101, NS125 Type | | | | | | | | | | | | | | | | | | | |
| Test Methods and Remarks | NR30/40/50/60/80, NRV20/30, NRH24/30, NRS20/40/50/60/80 Type, NR10050 Type, NS101/125 Type : The test samples shall be soldered to the test board by the reflow. The test samples shall be placed at specified temperature for specified time by step 1 to step 4 as shown in below table in sequence. The temperature cycle shall be repeated 100 cycles. <table border="1" style="margin: 10px auto;"> <thead> <tr> <th colspan="3">Conditions of 1 cycle</th> </tr> <tr> <th>Step</th> <th>Temperature ($^{\circ}\text{C}$)</th> <th>Duration (min)</th> </tr> </thead> <tbody> <tr> <td>1</td> <td>-40 ± 3</td> <td>30 ± 3</td> </tr> <tr> <td>2</td> <td>Room temperature</td> <td>Within 3</td> </tr> <tr> <td>3</td> <td>$+85\pm 2$</td> <td>30 ± 3</td> </tr> <tr> <td>4</td> <td>Room temperature</td> <td>Within 3</td> </tr> </tbody> </table> Recovery : At least 2hrs of recovery under the standard condition after the test, followed by the measurement within 48hrs. | | Conditions of 1 cycle | | | Step | Temperature ($^{\circ}\text{C}$) | Duration (min) | 1 | -40 ± 3 | 30 ± 3 | 2 | Room temperature | Within 3 | 3 | $+85\pm 2$ | 30 ± 3 | 4 | Room temperature | Within 3 |
| Conditions of 1 cycle | | | | | | | | | | | | | | | | | | | | |
| Step | Temperature ($^{\circ}\text{C}$) | Duration (min) | | | | | | | | | | | | | | | | | | |
| 1 | -40 ± 3 | 30 ± 3 | | | | | | | | | | | | | | | | | | |
| 2 | Room temperature | Within 3 | | | | | | | | | | | | | | | | | | |
| 3 | $+85\pm 2$ | 30 ± 3 | | | | | | | | | | | | | | | | | | |
| 4 | Room temperature | Within 3 | | | | | | | | | | | | | | | | | | |

| 17. Damp heat | | | | | | | | |
|--------------------------|---|--|-------------|---------------------------|----------|----------|------|----------------|
| Specified Value | NR30/40/50/60/80, NRV20/30, NRH24/30, NRS20/40/50/60/80 Type | Inductance change : Within $\pm 10\%$ No significant abnormality in appearance. | | | | | | |
| | NR10050 Type | | — | | | | | |
| | NS101, NS125 Type | Inductance change : Within $\pm 10\%$ No significant abnormality in appearance. | | | | | | |
| Test Methods and Remarks | NR30/40/50/60/80, NRV20/30, NRH24/30, NRS20/40/50/60/80 Type, NS101/125 Type : The test samples shall be soldered to the test board by the reflow. The test samples shall be placed in thermostatic oven set at specified temperature and humidity as shown in below table. <table border="1" style="margin: 10px auto;"> <tbody> <tr> <td>Temperature</td> <td>$60\pm 2^{\circ}\text{C}$</td> </tr> <tr> <td>Humidity</td> <td>90~95%RH</td> </tr> <tr> <td>Time</td> <td>500+24/-0 hour</td> </tr> </tbody> </table> Recovery : At least 2hrs of recovery under the standard condition after the test, followed by the measurement within 48hrs. | | Temperature | $60\pm 2^{\circ}\text{C}$ | Humidity | 90~95%RH | Time | 500+24/-0 hour |
| Temperature | $60\pm 2^{\circ}\text{C}$ | | | | | | | |
| Humidity | 90~95%RH | | | | | | | |
| Time | 500+24/-0 hour | | | | | | | |

| 18. Loading under damp heat | | | | | | | | | | |
|-----------------------------|---|--|-------------|---------------------------|----------|----------|-----------------|---------------|------|----------------|
| Specified Value | NR30/40/50/60/80, NRV20/30, NRH24/30, NRS20/40/50/60/80 Type | Inductance change : Within $\pm 10\%$ No significant abnormality in appearance. | | | | | | | | |
| | NR10050 Type | | | | | | | | | |
| | NS101, NS125 Type | | | | | | | | | |
| Test Methods and Remarks | NR30/40/50/60/80, NRV20/30, NRH24/30, NRS20/40/50/60/80 Type, NR10050 Type, NS101/125 Type : The test samples shall be soldered to the test board by the reflow. The test samples shall be placed in thermostatic oven set at specified temperature and humidity and applied the rated current continuously as shown in below table. <table border="1" style="margin: 10px auto;"> <tbody> <tr> <td>Temperature</td> <td>$60\pm 2^{\circ}\text{C}$</td> </tr> <tr> <td>Humidity</td> <td>90~95%RH</td> </tr> <tr> <td>Applied current</td> <td>Rated current</td> </tr> <tr> <td>Time</td> <td>500+24/-0 hour</td> </tr> </tbody> </table> Recovery : At least 2hrs of recovery under the standard condition after the test, followed by the measurement within 48hrs. | | Temperature | $60\pm 2^{\circ}\text{C}$ | Humidity | 90~95%RH | Applied current | Rated current | Time | 500+24/-0 hour |
| Temperature | $60\pm 2^{\circ}\text{C}$ | | | | | | | | | |
| Humidity | 90~95%RH | | | | | | | | | |
| Applied current | Rated current | | | | | | | | | |
| Time | 500+24/-0 hour | | | | | | | | | |

▶ This catalog contains the typical specification only due to the limitation of space. When you consider the purchase of our products, please check our specification.
 For details of each product (characteristics graph, reliability information, precautions for use, and so on), see our Web site (<http://www.ty-top.com/>).

| 19. Low temperature life test | | |
|---|--|--|
| Specified Value | NR30/40/50/60/80, NRV20/30, NRH24/30, NRS20/40/50/60/80 Type | Inductance change : Within $\pm 10\%$ No significant abnormality in appearance. |
| | NR10050 Type | |
| | NS101, NS125 Type | |
| Test Methods and Remarks | NR30/40/50/60/80, NRV20/30, NRH24/30, NRS20/40/50/60/80 Type, NR10050 Type, NS101/125 Type : The test samples shall be soldered to the test board by the reflow. After that, the test samples shall be placed at test conditions as shown in below table. | |
| | Temperature | $-40 \pm 2^\circ\text{C}$ |
| | Time | $500 + 24 / - 0$ hour |
| Recovery : At least 2hrs of recovery under the standard condition after the test, followed by the measurement within 48hrs. | | |
| 20. High temperature life test | | |
| Specified Value | NR30/40/50/60/80, NRV20/30, NRH24/30, NRS20/40/50/60/80 Type | — |
| | NR10050 Type | — |
| | NS101, NS125 Type | — |
| Test Methods and Remarks | NR10050 Type : | |
| | Temperature | $105 \pm 3^\circ\text{C}$ |
| | Time | $500 + 24 / - 0$ hour |
| Recovery : At least 2hrs of recovery under the standard condition after the test, followed by the measurement within 48hrs. | | |
| 21. Loading at high temperature life test | | |
| Specified Value | NR30/40/50/60/80, NRV20/30, NRH24/30, NRS20/40/50/60/80 Type | Inductance change : Within $\pm 10\%$ No significant abnormality in appearance. |
| | NR10050 Type | — |
| | NS101, NS125 Type | Inductance change : Within $\pm 10\%$ No significant abnormality in appearance. |
| Test Methods and Remarks | NR30/40/50/60/80, NRV30, NRH24/30, NRS40/50/60/80 Type, NS12555, NS12565, NS12575 Type : The test samples shall be soldered to the test board by the reflow soldering. | |
| | Temperature | $85 \pm 2^\circ\text{C}$ |
| | Applied current | Rated current |
| | Time | $500 + 24 / - 0$ hour |
| Recovery : At least 2hrs of recovery under the standard condition after the test, followed by the measurement within 48hrs. | | |
| 22. Standard condition | | |
| Specified Value | NR30/40/50/60/80, NRV20/30, NRH24/30, NRS20/40/50/60/80 Type | Standard test condition : Unless otherwise specified, temperature is $20 \pm 15^\circ\text{C}$ and $65 \pm 20\%$ of relative humidity. When there is any question concerning measurement result: In order to provide correlation data, the test shall be condition of $20 \pm 2^\circ\text{C}$ of temperature, $65 \pm 5\%$ relative humidity. Inductance is in accordance with our measured value. |
| | NR10050 Type | |
| | NS101, NS125 Type | |

SMD POWER INDUCTORS (NR□, NS SERIES)

PRECAUTIONS

1. Circuit Design

Precautions

◆ Operating environment

1. The products described in this specification are intended for use in general electronic equipment, (office supply equipment, telecommunications systems, measuring equipment, and household equipment). They are not intended for use in mission-critical equipment or systems requiring special quality and high reliability (traffic systems, safety equipment, aerospace systems, nuclear control systems and medical equipment including life-support systems,) where product failure might result in loss of life, injury or damage. For such uses, contact TAIYO YUDEN Sales Department in advance.

2. PCB Design

Precautions

◆ Land pattern design

1. Please refer to a recommended land pattern.
2. There is stress, which has been caused by distortion of a PCB, to the inductor.
(NR30/40/50/60/80, NRV20/30, NRH24/30, NRS20/30/40/50/60/80 Type)
3. Please consider the arrangement of parts on a PCB. (NR30/40/50/60/80, NRV20/30, NRH24/30, NRS20/30/40/50/60/80 Type)

Technical considerations

◆ Land pattern design

Surface Mounting

1. Mounting and soldering conditions should be checked beforehand.
2. Applicable soldering process to this products is reflow soldering only.
3. Please use the recommended land pattern shown as below. Electrical characteristics and the mounting ability of the product are being considered in the recommended land pattern. If a PCB is designed with other dimensions, defective soldering and stress to a product may occur due to misalignment. The performance of the product may not be brought out. If an adopted land pattern is different from the recommended land pattern, stress to the product will increase. It may cause cracks or defective electrical characteristics of the product. Please conduct validation completely before studying adoption of this product and please judge the pros and cons of adoption of this product with taking on responsibility.
(NR30/40/50/60/80, NRV20/30, NRH24/30, NRS20/30/40/50/60/80 Type)
4. As coefficients of thermal expansion between an inductor and a PCB differs, cracks may occur on a ferrite core when thermal stress is applied to them after mounting an inductor. (Please refer to the drawings below.) Please conduct validation completely before studying adoption of this product and please judge the pros and cons of adoption of this product with taking on responsibility.
(NR30/40/50/60/80, NRV20/30, NRH24/30, NRS20/30/40/50/60/80 Type)

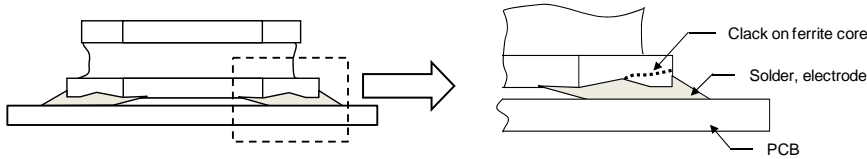

5. SMD inductors should be located to minimize any possible mechanical stresses from board warp or deflection. When splitting the PCB board after mounting inductors and other components, care is required so as not to give any stresses of deflection or twisting to the board.
(NR30/40/50/60/80, NRV20/30, NRH24/30, NRS20/30/40/50/60/80 Type)

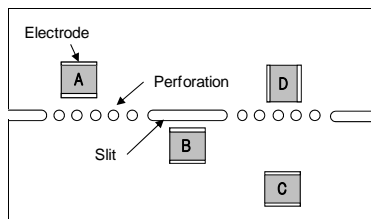

A product tends to undergo stress in order "A>C>B≡D".
Please consider the layouts of a product to minimize any stresses.

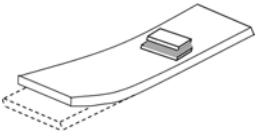
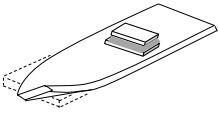
| 3. Considerations for automatic placement | |
|---|---|
| Precautions | <p>◆Adjustment of mounting machine</p> <ol style="list-style-type: none"> Excessive impact load should not be imposed on the products when mounting onto the PC boards. Mounting and soldering conditions should be checked beforehand. |
| Technical considerations | <p>◆Adjustment of mounting machine</p> <ol style="list-style-type: none"> When installing products, care should be taken not to apply distortion stress as it may deform the products. Stress may be applied to a product with a warp or a twist in handling of the product. Please conduct validation completely before studying adoption of this product and please judge the pros and cons of adoption of this product with taking on responsibility. (NR30/40/50/60/80, NRV20/30, NRH24/30, NRS20/30/40/50/60/80 Type) <div style="display: flex; justify-content: space-around; align-items: center;"> <div style="text-align: center;"> <p><Wrap></p>  </div> <div style="text-align: center;"> <p><Twist></p>  </div> </div> |

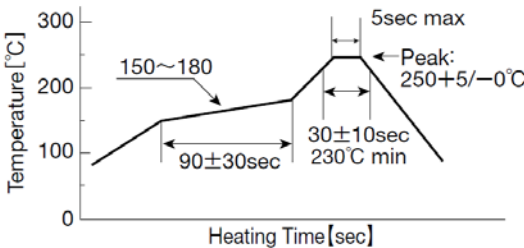
| 4. Soldering | |
|--------------------------|--|
| Precautions | <p>◆Reflow soldering</p> <ol style="list-style-type: none"> Please contact any of our offices for a reflow soldering, and refer to the recommended condition specified. The product shall be used reflow soldering only. Please do not add any stress to a product until it returns in normal temperature after reflow soldering. <p>◆Lead free soldering</p> <ol style="list-style-type: none"> When using products with lead free soldering, we request to use them after confirming adhesion, temperature of resistance to soldering heat, soldering etc sufficiently. <p>◆Recommended conditions for using a soldering iron (NR10050 Type)</p> <ul style="list-style-type: none"> Put the soldering iron on the land-pattern. Soldering iron's temperature - Below 350°C Duration - 3 seconds or less The soldering iron should not directly touch the inductor. |
| Technical considerations | <p>◆Reflow soldering</p> <ol style="list-style-type: none"> If products are used beyond the range of the recommended conditions, heat stresses may deform the products, and consequently degrade the reliability of the products. <p>•NR30/40/50/60/80, NRV20/30, NRH24/30, NRS20/40/50/60/80 Type, NR10050 Type, NS101/125 Type</p> <p>Recommended reflow condition (Pb free solder)</p>  |

| 5. Cleaning | |
|--------------------------|--|
| Precautions | <p>◆Cleaning conditions</p> <ol style="list-style-type: none"> Washing by supersonic waves shall be avoided. |
| Technical considerations | <p>◆Cleaning conditions</p> <ol style="list-style-type: none"> If washed by supersonic waves, the products might be broken. |

▶ This catalog contains the typical specification only due to the limitation of space. When you consider the purchase of our products, please check our specification. For details of each product (characteristics graph, reliability information, precautions for use, and so on), see our Web site (<http://www.ty-top.com/>)

| 6. Handling | |
|--------------------------|--|
| Precautions | <ul style="list-style-type: none"> ◆ Handling <ol style="list-style-type: none"> 1. Keep the product away from all magnets and magnetic objects. ◆ Breakaway PC boards (splitting along perforations) <ol style="list-style-type: none"> 1. When splitting the PC board after mounting product, care should be taken not to give any stresses of deflection or twisting to the board. 2. Board separation should not be done manually, but by using the appropriate devices. ◆ Mechanical considerations <ol style="list-style-type: none"> 1. Please do not give the product any excessive mechanical shocks. 2. Please do not add any shock and power to a product in transportation. ◆ Pick-up pressure <ol style="list-style-type: none"> 1. Please do not push to add any pressure to a winding part. Please do not give any shock and push into a ferrite core exposure part. ◆ Packing <ol style="list-style-type: none"> 1. Please avoid accumulation of a packing box as much as possible. |
| Technical considerations | <ul style="list-style-type: none"> ◆ Handling <ol style="list-style-type: none"> 1. There is a case that a characteristic varies with magnetic influence. ◆ Breakaway PC boards (splitting along perforations) <ol style="list-style-type: none"> 1. The position of the product on PCBs shall be carefully considered to minimize the stress caused from splitting of the PCBs. ◆ Mechanical considerations <ol style="list-style-type: none"> 1. There is a case to be damaged by a mechanical shock. 2. There is a case to be broken by the handling in transportation. ◆ Pick-up pressure <ol style="list-style-type: none"> 1. Damage and a characteristic can vary with an excessive shock or stress. ◆ Packing <ol style="list-style-type: none"> 1. If packing boxes are accumulated, that could cause a deformation on packing tapes or a damage on the products. |
| 7. Storage conditions | |
| Precautions | <ul style="list-style-type: none"> ◆ Storage <ol style="list-style-type: none"> 1. To maintain the solderability of terminal electrodes and to keep the packing material in good condition, temperature and humidity in the storage area should be controlled. <ul style="list-style-type: none"> ▪ Recommended conditions <ul style="list-style-type: none"> Ambient temperature : $-5\sim 40^{\circ}\text{C}$ Humidity : Below 70% RH ▪ The ambient temperature must be kept below 30°C. Even under ideal storage conditions, solderability of products electrodes may decrease as time passes. <p style="margin-left: 20px;">For this reason, product should be used within 6 months from the time of delivery. In case of storage over 6 months, solderability shall be checked before actual usage.</p> |
| Technical considerations | <ul style="list-style-type: none"> ◆ Storage <ol style="list-style-type: none"> 1. Under a high temperature and humidity environment, problems such as reduced solderability caused by oxidation of terminal electrodes and deterioration of taping/packaging materials may take place. |

Looking for pricing, stock, or lifecycle information?

Click below to explore more details on WIN SOURCE:

 [View NS12555T100MN on WIN SOURCE](#)

 [Taiyo Yuden Information](#)

Optimize Your Supply Chain with WIN SOURCE Solutions

-  Global Sourcing Solution
-  Obsolete Management
-  Cost Control Management
-  Shortage Management
-  Alternative Solution
-  Excess Inventory Management