



**THE DATASHEET OF  
SN74ALVCH162827DLR**



## FEATURES

- Member of the Texas Instruments Widebus™ Family
- Output Ports Have Equivalent 26-Ω Series Resistors, So No External Resistors Are Required
- Bus Hold on Data Inputs Eliminates the Need for External Pullup/Pulldown Resistors
- Latch-Up Performance Exceeds 250 mA Per JESD 17
- ESD Protection Exceeds JESD 22
  - 2000-V Human-Body Model (A114-A)
  - 200-V Machine Model (A115-A)
  - 1000-V Charged-Device Model (C101)

## DESCRIPTION/ORDERING INFORMATION

This 20-bit noninverting buffer/driver is designed for 1.65-V to 3.6-V  $V_{CC}$  operation.

The SN74ALVCH162827 is composed of two 10-bit sections with separate output-enable signals. For either 10-bit buffer section, the two output-enable ( $\overline{1OE1}$  and  $\overline{1OE2}$  or  $\overline{2OE1}$  and  $\overline{2OE2}$ ) inputs must both be low for the corresponding Y outputs to be active. If either output-enable input is high, the outputs of that 10-bit buffer section are in the high-impedance state.

The outputs, which are designed to sink up to 12 mA, include equivalent 26-Ω resistors to reduce overshoot and undershoot.

To ensure the high-impedance state during power up or power down,  $\overline{OE}$  should be tied to  $V_{CC}$  through a pullup resistor; the minimum value of the resistor is determined by the current-sinking capability of the driver.

Active bus-hold circuitry holds unused or undriven inputs at a valid logic state. Use of pullup or pulldown resistors with the bus-hold circuitry is not recommended.

DGG, DGV, OR DL PACKAGE  
(TOP VIEW)

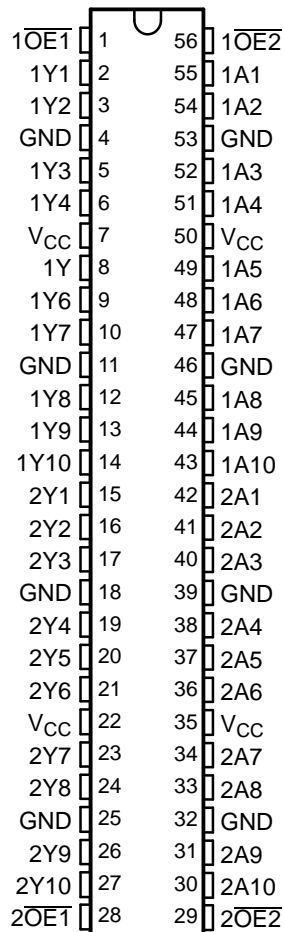

## ORDERING INFORMATION

$T_A$	PACKAGE <sup>(1)</sup>		ORDERABLE PART NUMBER	TOP-SIDE MARKING
-40°C to 85°C	SSOP - DL	Tube	SN74ALVCH162827DL	ALVCH162827
		Tape and reel	SN74ALVCH162827DLR	
	TSSOP - DGG	Tape and reel	SN74ALVCH162827GR	ALVCH162827
	TVSOP - DGV	Tape and reel	SN74ALVCH162827VR	VH2827

(1) Package drawings, standard packing quantities, thermal data, symbolization, and PCB design guidelines are available at [www.ti.com/sc/package](http://www.ti.com/sc/package).



Please be aware that an important notice concerning availability, standard warranty, and use in critical applications of Texas Instruments semiconductor products and disclaimers thereto appears at the end of this data sheet.

Widebus is a trademark of Texas Instruments.

# SN74ALVCH162827

## 20-BIT BUFFER/DRIVER

### WITH 3-STATE OUTPUTS

SCES013H—JULY 1995—REVISED AUGUST 2004

**FUNCTION TABLE**  
(each 10-bit section)

INPUTS			OUTPUT Y
$\overline{OE1}$	$\overline{OE2}$	A	
L	L	L	L
L	L	H	H
H	X	X	Z
X	H	X	Z

**LOGIC DIAGRAM (POSITIVE LOGIC)**

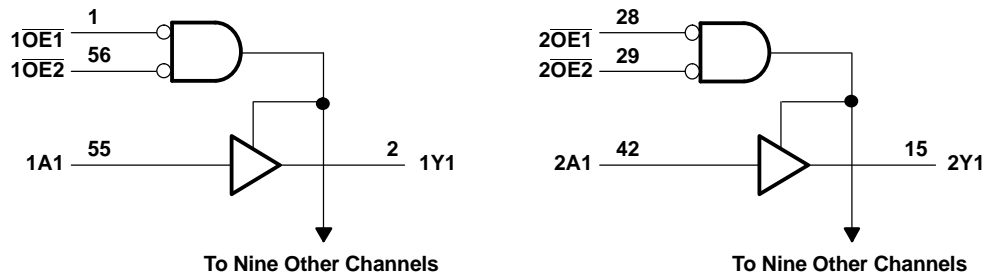

### ABSOLUTE MAXIMUM RATINGS<sup>(1)</sup>

over operating free-air temperature range (unless otherwise noted)

		MIN	MAX	UNIT
$V_{CC}$	Supply voltage range	-0.5	4.6	V
$V_I$	Input voltage range <sup>(2)</sup>	-0.5	4.6	V
$V_O$	Output voltage range <sup>(2)(3)</sup>	-0.5	$V_{CC} + 0.5$	V
$I_{IK}$	Input clamp current	$V_I < 0$	-50	mA
$I_{OK}$	Output clamp current	$V_O < 0$	-50	mA
$I_O$	Continuous output current		$\pm 50$	mA
	Continuous current through each $V_{CC}$ or GND		$\pm 100$	mA
$\theta_{JA}$	Package thermal impedance <sup>(4)</sup>	DGG package	64	°C/W
		DGV package	48	
		DL package	56	
$T_{stg}$	Storage temperature range	-65	150	°C

- (1) Stresses beyond those listed under "absolute maximum ratings" may cause permanent damage to the device. These are stress ratings only, and functional operation of the device at these or any other conditions beyond those indicated under "recommended operating conditions" is not implied. Exposure to absolute-maximum-rated conditions for extended periods may affect device reliability.
- (2) The input negative-voltage and output voltage ratings may be exceeded if the input and output current ratings are observed.
- (3) This value is limited to 4.6 V maximum.
- (4) The package thermal impedance is calculated in accordance with JESD 51-7.

**RECOMMENDED OPERATING CONDITIONS<sup>(1)</sup>**

		MIN	MAX	UNIT
$V_{CC}$	Supply voltage	1.65	3.6	V
$V_{IH}$	High-level input voltage	$V_{CC} = 1.65\text{ V to }1.95\text{ V}$	$0.65 \times V_{CC}$	V
		$V_{CC} = 2.3\text{ V to }2.7\text{ V}$	1.7	
		$V_{CC} = 2.7\text{ V to }3.6\text{ V}$	2	
$V_{IL}$	Low-level input voltage	$V_{CC} = 1.65\text{ V to }1.95\text{ V}$	$0.35 \times V_{CC}$	V
		$V_{CC} = 2.3\text{ V to }2.7\text{ V}$	0.7	
		$V_{CC} = 2.7\text{ V to }3.6\text{ V}$	0.8	
$V_I$	Input voltage	0	$V_{CC}$	V
$V_O$	Output voltage	0	$V_{CC}$	V
$I_{OH}$	High-level output current	$V_{CC} = 1.65\text{ V}$	-2	mA
		$V_{CC} = 2.3\text{ V}$	-6	
		$V_{CC} = 2.7\text{ V}$	-8	
		$V_{CC} = 3\text{ V}$	-12	
$I_{OL}$	Low-level output current	$V_{CC} = 1.65\text{ V}$	2	mA
		$V_{CC} = 2.3\text{ V}$	6	
		$V_{CC} = 2.7\text{ V}$	8	
		$V_{CC} = 3\text{ V}$	12	
$\Delta t/\Delta v$	Input transition rise or fall rate		10	ns/V
$T_A$	Operating free-air temperature	-40	85	°C

(1) All unused control inputs of the device must be held at  $V_{CC}$  or GND to ensure proper device operation. Refer to the TI application report, *Implications of Slow or Floating CMOS Inputs*, literature number SCBA004.

**SN74ALVCH162827**  
**20-BIT BUFFER/DRIVER**  
**WITH 3-STATE OUTPUTS**

SCES013H–JULY 1995–REVISED AUGUST 2004

**ELECTRICAL CHARACTERISTICS**

over recommended operating free-air temperature range (unless otherwise noted)

PARAMETER	TEST CONDITIONS	V <sub>CC</sub>	MIN	TYP <sup>(1)</sup>	MAX	UNIT
V <sub>OH</sub>	I <sub>OH</sub> = -100 μA	1.65 V to 3.6 V	V <sub>CC</sub> - 0.2			V
	I <sub>OH</sub> = -2 mA	1.65 V	1.2			
	I <sub>OH</sub> = -4 mA	2.3 V	1.9			
	I <sub>OH</sub> = -6 mA	2.3 V	1.7			
		3 V	2.4			
	I <sub>OH</sub> = -8 mA	2.7 V	2			
I <sub>OH</sub> = -12 mA	3 V	2				
V <sub>OL</sub>	I <sub>OL</sub> = 100 μA	1.65 V to 3.6 V			0.2	V
	I <sub>OL</sub> = 2 mA	1.65 V			0.45	
	I <sub>OL</sub> = 4 mA	2.3 V			0.4	
	I <sub>OL</sub> = 6 mA	2.3 V			0.55	
		3 V			0.55	
	I <sub>OL</sub> = 8 mA	2.7 V			0.6	
I <sub>OL</sub> = 12 mA	3 V			0.8		
I <sub>I</sub>	V <sub>I</sub> = V <sub>CC</sub> or GND	3.6 V			±5	μA
I <sub>I(hold)</sub>	V <sub>I</sub> = 0.58 V	1.65 V	25			μA
	V <sub>I</sub> = 1.07 V	1.65 V	-25			
	V <sub>I</sub> = 0.7 V	2.3 V	45			
	V <sub>I</sub> = 1.7 V	2.3 V	-45			
	V <sub>I</sub> = 0.8 V	3 V	75			
	V <sub>I</sub> = 2 V	3 V	-75			
	V <sub>I</sub> = 0 to 3.6 V <sup>(2)</sup>	3.6 V			±500	
I <sub>OZ</sub>	V <sub>O</sub> = V <sub>CC</sub> or GND	3.6 V			±10	μA
I <sub>CC</sub>	V <sub>I</sub> = V <sub>CC</sub> or GND, I <sub>O</sub> = 0	3.6 V			40	μA
ΔI <sub>CC</sub>	One input at V <sub>CC</sub> - 0.6 V, Other inputs at V <sub>CC</sub> or GND	3 V to 3.6 V			750	μA
C <sub>i</sub>	Control inputs	V <sub>I</sub> = V <sub>CC</sub> or GND	3.3 V	3.5		pF
	Data inputs			6		
C <sub>o</sub>	Outputs	V <sub>O</sub> = V <sub>CC</sub> or GND	3.3 V	7		pF

(1) All typical values are at V<sub>CC</sub> = 3.3 V, T<sub>A</sub> = 25°C.

(2) This is the bus-hold maximum dynamic current. It is the minimum overdrive current required to switch the input from one state to another.

## SWITCHING CHARACTERISTICS

over recommended operating free-air temperature range (unless otherwise noted) (see Figure 1)

PARAMETER	FROM (INPUT)	TO (OUTPUT)	$V_{CC} = 1.8\text{ V}$	$V_{CC} = 2.5\text{ V}$ $\pm 0.2\text{ V}$		$V_{CC} = 2.7\text{ V}$		$V_{CC} = 3.3\text{ V}$ $\pm 0.3\text{ V}$		UNIT
			TYP	MIN	MAX	MIN	MAX	MIN	MAX	
$t_{pd}$	A	Y	(1)	1	4.4	4.4	1.5	3.8	ns	
$t_{en}$	$\overline{OE}$	Y	(1)	1.4	6.3	6.2	1.6	5.1	ns	
$t_{dis}$	$\overline{OE}$	Y	(1)	1.7	5.9	5.2	1.8	4.7	ns	
$t_{sk(LH)}^{(2)}$	A	Y	(1)	0.5		0.5	0.5		ns	
$t_{sk(HL)}^{(2)}$			(1)	0.5		0.5	0.5			

(1) This information was not available at the time of publication.

(2) Parameter specified by design

$$t_{sk(LH)} = |t_{PLH}(m) - t_{PLH}(n)|$$

$$t_{sk(HL)} = |t_{PHL}(m) - t_{PHL}(n)|$$

where m and n are any arbitrary data bits.

## OPERATING CHARACTERISTICS

$T_A = 25^\circ\text{C}$

PARAMETER		TEST CONDITIONS	$V_{CC} = 1.8\text{ V}$	$V_{CC} = 2.5\text{ V}$	$V_{CC} = 3.3\text{ V}$	UNIT
			TYP	TYP	TYP	
$C_{pd}$	Power dissipation capacitance	$C_L = 50\text{ pF}, f = 10\text{ MHz}$	(1)	16	18	pF
	Outputs enabled		(1)	4	6	
	Outputs disabled					

(1) This information was not available at the time of publication.

**PARAMETER MEASUREMENT INFORMATION**

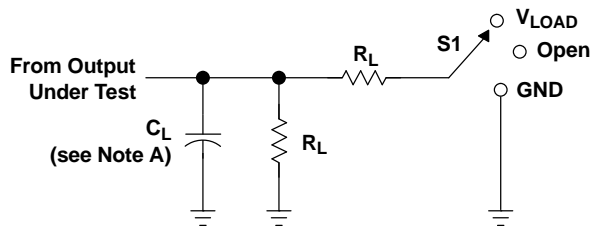

TEST	S1
$t_{pd}$	Open
$t_{PLZ}/t_{PZL}$	$V_{LOAD}$
$t_{PHZ}/t_{PZH}$	GND

**LOAD CIRCUIT**

$V_{CC}$	INPUT		$V_M$	$V_{LOAD}$	$C_L$	$R_L$	$V_{\Delta}$
	$V_I$	$t_r/t_f$					
1.8 V	$V_{CC}$	$\leq 2$ ns	$V_{CC}/2$	$2 \times V_{CC}$	30 pF	1 k $\Omega$	0.15 V
$2.5 V \pm 0.2 V$	$V_{CC}$	$\leq 2$ ns	$V_{CC}/2$	$2 \times V_{CC}$	30 pF	500 $\Omega$	0.15 V
2.7 V	2.7 V	$\leq 2.5$ ns	1.5 V	6 V	50 pF	500 $\Omega$	0.3 V
$3 V \pm 0.3 V$	2.7 V	$\leq 2.5$ ns	1.5 V	6 V	50 pF	500 $\Omega$	0.3 V

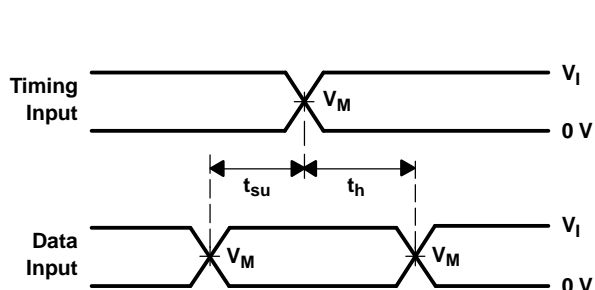

**VOLTAGE WAVEFORMS  
SETUP AND HOLD TIMES**

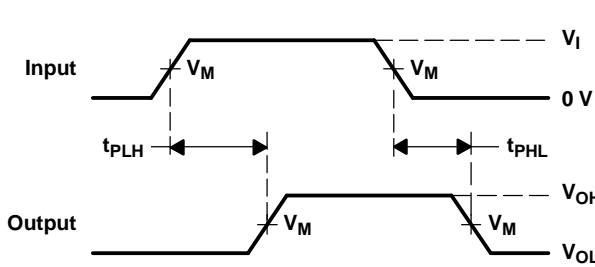

**VOLTAGE WAVEFORMS  
PROPAGATION DELAY TIMES**

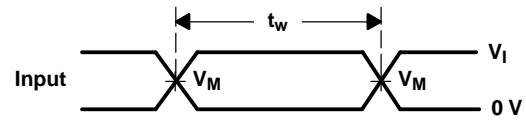

**VOLTAGE WAVEFORMS  
PULSE DURATION**

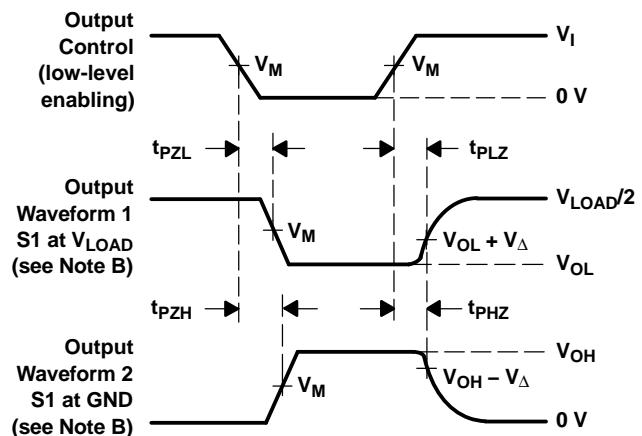

**VOLTAGE WAVEFORMS  
ENABLE AND DISABLE TIMES**

- NOTES: A.  $C_L$  includes probe and jig capacitance.  
B. Waveform 1 is for an output with internal conditions such that the output is low, except when disabled by the output control. Waveform 2 is for an output with internal conditions such that the output is high, except when disabled by the output control.  
C. All input pulses are supplied by generators having the following characteristics:  $PRR \leq 10$  MHz,  $Z_O = 50 \Omega$ .  
D. The outputs are measured one at a time, with one transition per measurement.  
E.  $t_{PLZ}$  and  $t_{PHZ}$  are the same as  $t_{dis}$ .  
F.  $t_{PZL}$  and  $t_{PZH}$  are the same as  $t_{en}$ .  
G.  $t_{PLH}$  and  $t_{PHL}$  are the same as  $t_{pd}$ .  
H. All parameters and waveforms are not applicable to all devices.

**Figure 1. Load Circuit and Voltage Waveforms**

**PACKAGING INFORMATION**

Orderable Device	Status <sup>(1)</sup>	Package Type	Package Drawing	Pins	Package Qty	Eco Plan <sup>(2)</sup>	Lead/Ball Finish	MSL Peak Temp <sup>(3)</sup>
74ALVCH162827DLG4	ACTIVE	SSOP	DL	56	20	Green (RoHS & no Sb/Br)	CU NIPDAU	Level-1-260C-UNLIM
74ALVCH162827DLRG4	ACTIVE	SSOP	DL	56	1000	Green (RoHS & no Sb/Br)	CU NIPDAU	Level-1-260C-UNLIM
74ALVCH162827GRE4	ACTIVE	TSSOP	DGG	56	2000	Green (RoHS & no Sb/Br)	CU NIPDAU	Level-1-260C-UNLIM
74ALVCH162827GRG4	ACTIVE	TSSOP	DGG	56	2000	Green (RoHS & no Sb/Br)	CU NIPDAU	Level-1-260C-UNLIM
74ALVCH162827VRE4	ACTIVE	TVSOP	DGV	56	2000	Green (RoHS & no Sb/Br)	CU NIPDAU	Level-1-260C-UNLIM
74ALVCH162827VRG4	ACTIVE	TVSOP	DGV	56	2000	Green (RoHS & no Sb/Br)	CU NIPDAU	Level-1-260C-UNLIM
SN74ALVCH162827DGGR	OBSOLETE	TSSOP	DGG	56		TBD	Call TI	Call TI
SN74ALVCH162827DL	ACTIVE	SSOP	DL	56	20	Green (RoHS & no Sb/Br)	CU NIPDAU	Level-1-260C-UNLIM
SN74ALVCH162827DLR	ACTIVE	SSOP	DL	56	1000	Green (RoHS & no Sb/Br)	CU NIPDAU	Level-1-260C-UNLIM
SN74ALVCH162827GR	ACTIVE	TSSOP	DGG	56	2000	Green (RoHS & no Sb/Br)	CU NIPDAU	Level-1-260C-UNLIM
SN74ALVCH162827VR	ACTIVE	TVSOP	DGV	56	2000	Green (RoHS & no Sb/Br)	CU NIPDAU	Level-1-260C-UNLIM

<sup>(1)</sup> The marketing status values are defined as follows:

**ACTIVE:** Product device recommended for new designs.

**LIFEBUY:** TI has announced that the device will be discontinued, and a lifetime-buy period is in effect.

**NRND:** Not recommended for new designs. Device is in production to support existing customers, but TI does not recommend using this part in a new design.

**PREVIEW:** Device has been announced but is not in production. Samples may or may not be available.

**OBSOLETE:** TI has discontinued the production of the device.

<sup>(2)</sup> Eco Plan - The planned eco-friendly classification: Pb-Free (RoHS), Pb-Free (RoHS Exempt), or Green (RoHS & no Sb/Br) - please check <http://www.ti.com/productcontent> for the latest availability information and additional product content details.

**TBD:** The Pb-Free/Green conversion plan has not been defined.

**Pb-Free (RoHS):** TI's terms "Lead-Free" or "Pb-Free" mean semiconductor products that are compatible with the current RoHS requirements for all 6 substances, including the requirement that lead not exceed 0.1% by weight in homogeneous materials. Where designed to be soldered at high temperatures, TI Pb-Free products are suitable for use in specified lead-free processes.

**Pb-Free (RoHS Exempt):** This component has a RoHS exemption for either 1) lead-based flip-chip solder bumps used between the die and package, or 2) lead-based die adhesive used between the die and leadframe. The component is otherwise considered Pb-Free (RoHS compatible) as defined above.

**Green (RoHS & no Sb/Br):** TI defines "Green" to mean Pb-Free (RoHS compatible), and free of Bromine (Br) and Antimony (Sb) based flame retardants (Br or Sb do not exceed 0.1% by weight in homogeneous material)

<sup>(3)</sup> MSL, Peak Temp. -- The Moisture Sensitivity Level rating according to the JEDEC industry standard classifications, and peak solder temperature.

**Important Information and Disclaimer:**The information provided on this page represents TI's knowledge and belief as of the date that it is provided. TI bases its knowledge and belief on information provided by third parties, and makes no representation or warranty as to the accuracy of such information. Efforts are underway to better integrate information from third parties. TI has taken and continues to take reasonable steps to provide representative and accurate information but may not have conducted destructive testing or chemical analysis on incoming materials and chemicals. TI and TI suppliers consider certain information to be proprietary, and thus CAS numbers and other limited information may not be available for release.

In no event shall TI's liability arising out of such information exceed the total purchase price of the TI part(s) at issue in this document sold by TI to Customer on an annual basis.

**TAPE AND REEL INFORMATION**



**QUADRANT ASSIGNMENTS FOR PIN 1 ORIENTATION IN TAPE**

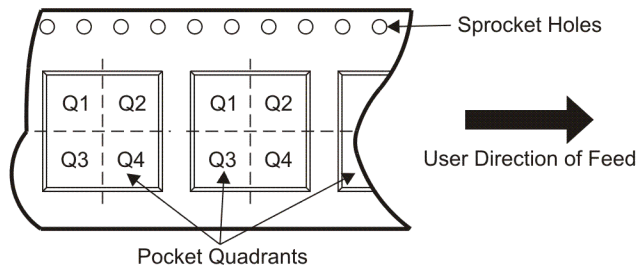

\*All dimensions are nominal

Device	Package Type	Package Drawing	Pins	SPQ	Reel Diameter (mm)	Reel Width W1 (mm)	A0 (mm)	B0 (mm)	K0 (mm)	P1 (mm)	W (mm)	Pin1 Quadrant
SN74ALVCH162827DLR	SSOP	DL	56	1000	330.0	32.4	11.35	18.67	3.1	16.0	32.0	Q1
SN74ALVCH162827GR	TSSOP	DGG	56	2000	330.0	24.4	8.6	15.6	1.8	12.0	24.0	Q1
SN74ALVCH162827VR	TVSOP	DGV	56	2000	330.0	24.4	6.8	11.7	1.6	12.0	24.0	Q1

**TAPE AND REEL BOX DIMENSIONS**



\*All dimensions are nominal

Device	Package Type	Package Drawing	Pins	SPQ	Length (mm)	Width (mm)	Height (mm)
SN74ALVCH162827DLR	SSOP	DL	56	1000	346.0	346.0	49.0
SN74ALVCH162827GR	TSSOP	DGG	56	2000	346.0	346.0	41.0
SN74ALVCH162827VR	TVSOP	DGV	56	2000	346.0	346.0	41.0

DGG (R-PDSO-G\*\*)

PLASTIC SMALL-OUTLINE PACKAGE

48 PINS SHOWN



- NOTES: A. All linear dimensions are in millimeters.  
 B. This drawing is subject to change without notice.  
 C. Body dimensions do not include mold protrusion not to exceed 0,15.  
 D. Falls within JEDEC MO-153

DL (R-PDSO-G\*\*)

PLASTIC SMALL-OUTLINE PACKAGE

48 PINS SHOWN



- NOTES: A. All linear dimensions are in inches (millimeters).  
 B. This drawing is subject to change without notice.  
 C. Body dimensions do not include mold flash or protrusion not to exceed 0.006 (0,15).  
 D. Falls within JEDEC MO-118

DGV (R-PDSO-G\*\*)

PLASTIC SMALL-OUTLINE

24 PINS SHOWN



4073251/E 08/00

- NOTES: A. All linear dimensions are in millimeters.  
 B. This drawing is subject to change without notice.  
 C. Body dimensions do not include mold flash or protrusion, not to exceed 0,15 per side.  
 D. Falls within JEDEC: 24/48 Pins – MO-153  
 14/16/20/56 Pins – MO-194

## IMPORTANT NOTICE

Texas Instruments Incorporated and its subsidiaries (TI) reserve the right to make corrections, modifications, enhancements, improvements, and other changes to its products and services at any time and to discontinue any product or service without notice. Customers should obtain the latest relevant information before placing orders and should verify that such information is current and complete. All products are sold subject to TI's terms and conditions of sale supplied at the time of order acknowledgment.

TI warrants performance of its hardware products to the specifications applicable at the time of sale in accordance with TI's standard warranty. Testing and other quality control techniques are used to the extent TI deems necessary to support this warranty. Except where mandated by government requirements, testing of all parameters of each product is not necessarily performed.

TI assumes no liability for applications assistance or customer product design. Customers are responsible for their products and applications using TI components. To minimize the risks associated with customer products and applications, customers should provide adequate design and operating safeguards.

TI does not warrant or represent that any license, either express or implied, is granted under any TI patent right, copyright, mask work right, or other TI intellectual property right relating to any combination, machine, or process in which TI products or services are used. Information published by TI regarding third-party products or services does not constitute a license from TI to use such products or services or a warranty or endorsement thereof. Use of such information may require a license from a third party under the patents or other intellectual property of the third party, or a license from TI under the patents or other intellectual property of TI.

Reproduction of TI information in TI data books or data sheets is permissible only if reproduction is without alteration and is accompanied by all associated warranties, conditions, limitations, and notices. Reproduction of this information with alteration is an unfair and deceptive business practice. TI is not responsible or liable for such altered documentation. Information of third parties may be subject to additional restrictions.

Resale of TI products or services with statements different from or beyond the parameters stated by TI for that product or service voids all express and any implied warranties for the associated TI product or service and is an unfair and deceptive business practice. TI is not responsible or liable for any such statements.

TI products are not authorized for use in safety-critical applications (such as life support) where a failure of the TI product would reasonably be expected to cause severe personal injury or death, unless officers of the parties have executed an agreement specifically governing such use. Buyers represent that they have all necessary expertise in the safety and regulatory ramifications of their applications, and acknowledge and agree that they are solely responsible for all legal, regulatory and safety-related requirements concerning their products and any use of TI products in such safety-critical applications, notwithstanding any applications-related information or support that may be provided by TI. Further, Buyers must fully indemnify TI and its representatives against any damages arising out of the use of TI products in such safety-critical applications.

TI products are neither designed nor intended for use in military/aerospace applications or environments unless the TI products are specifically designated by TI as military-grade or "enhanced plastic." Only products designated by TI as military-grade meet military specifications. Buyers acknowledge and agree that any such use of TI products which TI has not designated as military-grade is solely at the Buyer's risk, and that they are solely responsible for compliance with all legal and regulatory requirements in connection with such use.

TI products are neither designed nor intended for use in automotive applications or environments unless the specific TI products are designated by TI as compliant with ISO/TS 16949 requirements. Buyers acknowledge and agree that, if they use any non-designated products in automotive applications, TI will not be responsible for any failure to meet such requirements.

Following are URLs where you can obtain information on other Texas Instruments products and application solutions:

### Products

Amplifiers	<a href="http://amplifier.ti.com">amplifier.ti.com</a>
Data Converters	<a href="http://dataconverter.ti.com">dataconverter.ti.com</a>
DSP	<a href="http://dsp.ti.com">dsp.ti.com</a>
Clocks and Timers	<a href="http://www.ti.com/clocks">www.ti.com/clocks</a>
Interface	<a href="http://interface.ti.com">interface.ti.com</a>
Logic	<a href="http://logic.ti.com">logic.ti.com</a>
Power Mgmt	<a href="http://power.ti.com">power.ti.com</a>
Microcontrollers	<a href="http://microcontroller.ti.com">microcontroller.ti.com</a>
RFID	<a href="http://www.ti-rfid.com">www.ti-rfid.com</a>
RF/IF and ZigBee® Solutions	<a href="http://www.ti.com/lprf">www.ti.com/lprf</a>

### Applications

Audio	<a href="http://www.ti.com/audio">www.ti.com/audio</a>
Automotive	<a href="http://www.ti.com/automotive">www.ti.com/automotive</a>
Broadband	<a href="http://www.ti.com/broadband">www.ti.com/broadband</a>
Digital Control	<a href="http://www.ti.com/digitalcontrol">www.ti.com/digitalcontrol</a>
Medical	<a href="http://www.ti.com/medical">www.ti.com/medical</a>
Military	<a href="http://www.ti.com/military">www.ti.com/military</a>
Optical Networking	<a href="http://www.ti.com/opticalnetwork">www.ti.com/opticalnetwork</a>
Security	<a href="http://www.ti.com/security">www.ti.com/security</a>
Telephony	<a href="http://www.ti.com/telephony">www.ti.com/telephony</a>
Video & Imaging	<a href="http://www.ti.com/video">www.ti.com/video</a>
Wireless	<a href="http://www.ti.com/wireless">www.ti.com/wireless</a>

Mailing Address: Texas Instruments, Post Office Box 655303, Dallas, Texas 75265  
Copyright © 2008, Texas Instruments Incorporated

## Looking for pricing, stock, or lifecycle information?

Click below to explore more details on WIN SOURCE:

 [View SN74ALVCH162827DLR on WIN SOURCE](#)

 [Texas Instruments](#) Information

## Optimize Your Supply Chain with WIN SOURCE Solutions

-  Global Sourcing Solution
-  Obsolete Management
-  Cost Control Management
-  Shortage Management
-  Alternative Solution
-  Excess Inventory Management