



**THE DATASHEET OF  
LPV358DGKRG4**



# LPV321 SINGLE, LPV358 DUAL, LPV324 QUAD GENERAL-PURPOSE, LOW-VOLTAGE, LOW-POWER, RAIL-TO-RAIL OUTPUT OPERATIONAL AMPLIFIERS

SLOS433I – FEBRUARY 2004 – REVISED MARCH 2005

- 2.7-V and 5-V Performance
- $-40^{\circ}\text{C}$  to  $125^{\circ}\text{C}$  Specification at 5 V
- No Crossover Distortion
- Gain Bandwidth of 152 kHz
- Low Supply Current
  - LPV321 . . .  $9\ \mu\text{A}$
  - LPV358 . . .  $15\ \mu\text{A}$
  - LPV324 . . .  $28\ \mu\text{A}$
- Rail-to-Rail Output Swing at 100-k $\Omega$  Load
  - $V_{\text{CC}+}$  – 3.5 mV
  - $V_{\text{CC}-}$  + 90 mV
- $V_{\text{ICR}}$  . . .  $-0.2\ \text{V}$  to  $V_{\text{CC}+} - 0.8\ \text{V}$
- Stable With Capacitive Load of 1000 pF
- Applications
  - Active Filters
  - General-Purpose, Low-Voltage Applications
  - Low-Power and/or Portable Applications
- Latch-Up Performance Exceeds 100 mA per JESD 78, Class II
- ESD Protection Exceeds JESD 22
  - 2000-V Human-Body Model (A114-A)
  - 200-V Machine Model (A115-A)
  - 1000-V Charged-Device Model (C101)

LPV321 . . . DBV OR DCK PACKAGE  
(TOP VIEW)



LPV358 . . . D, DDU, OR DGK PACKAGE  
(TOP VIEW)

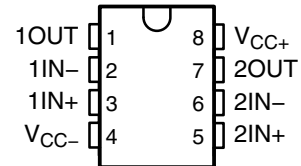

LPV324 . . . D OR PW PACKAGE  
(TOP VIEW)

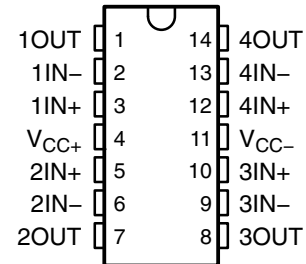

## description/ordering information

The LPV321/358/324 devices are low-power ( $9\ \mu\text{A}$  per channel at 5 V) versions of the LMV321/358/324 operational amplifiers. These are additions to the LMV321/358/324 family of commodity operational amplifiers.

The LPV321/358/324 devices are the most cost-effective solutions for applications where low voltage, low-power operation, space saving, and low price are needed. These devices have rail-to-rail output-swing capability, and the input common-mode voltage range includes ground. They all exhibit excellent speed-power ratios, achieving 152 kHz of bandwidth, with a supply current of only  $9\ \mu\text{A}$  typical.

The LPV321, LPV358, and LPV324 are characterized for operation from  $-40^{\circ}\text{C}$  to  $85^{\circ}\text{C}$ . The LPV321I, LPV358I, and LPV324I are characterized for operation from  $-40^{\circ}\text{C}$  to  $125^{\circ}\text{C}$ .



Please be aware that an important notice concerning availability, standard warranty, and use in critical applications of Texas Instruments semiconductor products and disclaimers thereto appears at the end of this data sheet.

PRODUCTION DATA information is current as of publication date. Products conform to specifications per the terms of Texas Instruments standard warranty. Production processing does not necessarily include testing of all parameters.

 **TEXAS  
INSTRUMENTS**

POST OFFICE BOX 655303 • DALLAS, TEXAS 75265

Copyright © 2005, Texas Instruments Incorporated

**LPV321 SINGLE, LPV358 DUAL, LPV324 QUAD  
GENERAL-PURPOSE, LOW-VOLTAGE, LOW-POWER, RAIL-TO-RAIL OUTPUT  
OPERATIONAL AMPLIFIERS**

SLOS433I – FEBRUARY 2004 – REVISED MARCH 2005

description/ordering information (continued)

**ORDERING INFORMATION**

T <sub>A</sub>	PACKAGE†		ORDERABLE PART NUMBER	TOP-SIDE MARKING	
-40°C to 85°C	Single	SOT23-5 (DBV)	Reel of 3000	LPV321DBVR	5C7_
			Reel of 250	LPV321DBVT	PREVIEW
		SC-70 (DCK)	Reel of 3000	LPV321DCKR	52_
			Reel of 250	LPV321DCKT	PREVIEW
	Dual	SOIC-8 (D)	Tube of 75	LPV358D	PV358
			Reel of 2500	LPV358DR	
		VSSOP-8 (DDU)	Reel of 3000	LPV358DDUR	5A56
			Reel of 2500	LPV358DGKR	546
		VSSOP-8 (DGK)	Reel of 250	LPV358DGKT	PREVIEW
	Quad	SOIC-14 (D)	Tube of 50	LPV324D	LPV324
			Reel of 2500	LPV324DR	
TSSOP-14 (PW)		Tube of 90	LPV324PW	PV324	
		Reel of 2000	LPV324PWR		
-40°C to 125°C	Single	SOT23-5 (DBV)	Reel of 3000	LPV321IDBVR	5C1_
			Reel of 250	LPV321IDBVT	PREVIEW
		SC-70 (DCK)	Reel of 3000	LPV321IDCKR	53_
			Reel of 250	LPV321IDCKT	PREVIEW
	Dual	SOIC-8 (D)	Tube of 75	LPV358ID	PV358I
			Reel of 2500	LPV358IDR	
		VSSOP-8 (DDU)	Reel of 3000	LPV358IDDUR	5AE6
			Reel of 2500	LPV358IDGKR	556
		VSSOP-8 (DGK)	Reel of 250	LPV358IDGKT	PREVIEW
	Quad	SOIC-14 (D)	Tube of 50	LPV324ID	LPV324I
			Reel of 2500	LPV324IDR	
TSSOP-14 (PW)		Tube of 90	LPV324IPW	PV324I	
		Reel of 2000	LPV324IPWR		

† Package drawings, standard packing quantities, thermal data, symbolization, and PCB design guidelines are available at [www.ti.com/sc/package](http://www.ti.com/sc/package).

‡ DBV/DCK: The actual top-side marking has one additional character that designates the assembly/test site.

symbol (each amplifier)

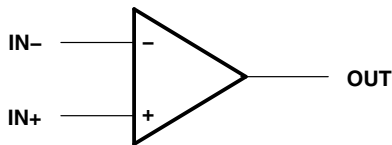

**LPV321 SINGLE, LPV358 DUAL, LPV324 QUAD  
GENERAL-PURPOSE, LOW-VOLTAGE, LOW-POWER, RAIL-TO-RAIL OUTPUT  
OPERATIONAL AMPLIFIERS**

SLOS433I – FEBRUARY 2004 – REVISED MARCH 2005

**LPV324 simplified schematic**



**absolute maximum ratings over operating free-air temperature range (unless otherwise noted)†**

Supply voltage, $V_{CC+} - V_{CC-}$ (see Note 1)	5.5 V
Differential input voltage, $V_{ID}$ (see Note 2)	$\pm V_{CC}$
Input voltage range, $V_I$ (either input)	$V_{CC-}$ to $V_{CC+} - 1$ V
Package thermal impedance, $\theta_{JA}$ (see Notes 3 and 4):	
5-pin DBV package	206°C/W
5-pin DCK package	252°C/W
8-pin D package	97°C/W
8-pin DDU package	TBD°C/W
8-pin DGK package	172°C/W
14-pin D package	86°C/W
14-pin PW package	113°C/W
Maximum junction temperature, $T_J$	150°C
Storage temperature range, $T_{stg}$	-65°C to 150°C

† Stresses beyond those listed under “absolute maximum ratings” may cause permanent damage to the device. These are stress ratings only, and functional operation of the device at these or any other conditions beyond those indicated under “recommended operating conditions” is not implied. Exposure to absolute-maximum-rated conditions for extended periods may affect device reliability.

- NOTES:
1. All voltage values, except differential voltages and  $V_{CC}$  specified for the measurement of  $I_{OS}$ , are with respect to the network GND.
  2. Differential voltages are at IN+ with respect to IN-.
  3. Maximum power dissipation is a function of  $T_J(\text{max})$ ,  $\theta_{JA}$ , and  $T_A$ . The maximum allowable power dissipation at any allowable ambient temperature is  $P_D = (T_J(\text{max}) - T_A)/\theta_{JA}$ . Selecting the maximum of 150°C can affect reliability.
  4. The package thermal impedance is calculated in accordance with JESD 51-7.

# LPV321 SINGLE, LPV358 DUAL, LPV324 QUAD GENERAL-PURPOSE, LOW-VOLTAGE, LOW-POWER, RAIL-TO-RAIL OUTPUT OPERATIONAL AMPLIFIERS

SLOS433I – FEBRUARY 2004 – REVISED MARCH 2005

## recommended operating conditions

		MIN	MAX	UNIT	
V <sub>CC</sub>	Supply voltage	2.7	5	V	
T <sub>A</sub>	Operating free-air temperature	LPV3xx	-40	85	°C
		LPV3xxI	-40	125	

## ESD protection

TEST CONDITIONS	TYP	UNIT
Human-Body Model	2	kV
Machine model	200	V
Charged-Device Model	1	kV

# LPV321 SINGLE, LPV358 DUAL, LPV324 QUAD GENERAL-PURPOSE, LOW-VOLTAGE, LOW-POWER, RAIL-TO-RAIL OUTPUT OPERATIONAL AMPLIFIERS

SLOS433I – FEBRUARY 2004 – REVISED MARCH 2005

## 2.7-V electrical characteristics

$T_A = 25^\circ\text{C}$ ,  $V_{CC+} = 2.7\text{ V}$ ,  $V_{CC-} = 0\text{ V}$ ,  $V_{IC} = 1\text{ V}$ ,  $V_O = V_{CC+}/2$ , and  $R_L > 1\text{ M}\Omega$  (unless otherwise noted)

PARAMETER		TEST CONDITIONS		MIN	TYP†	MAX	UNIT
$V_{IO}$	Input offset voltage				1.2	7	mV
$\alpha_{VIO}$	Average temperature coefficient of input offset voltage				4		$\mu\text{V}/^\circ\text{C}$
$I_{IB}$	Input bias current				1.7	50	nA
$I_{IO}$	Input offset current				0.6	40	nA
CMRR	Common-mode rejection ratio	$0 \leq V_{IC} \leq 1.7\text{ V}$		50	70		dB
$k_{SVR}$	Supply-voltage rejection ratio	$2.7\text{ V} \leq V_{CC+} \leq 5\text{ V}$ , $V_{IC} = 1\text{ V}$ , $V_O = 1\text{ V}$		50	65		dB
$V_{ICR}$	Common-mode input voltage range	CMRR $\geq 50\text{ dB}$		0 to 1.7	-0.2 to 1.9		V
$V_O$	Output swing	$R_L = 100\text{ k}\Omega$ to 1.35 V	High level	$V_{CC+} - 0.100$	$V_{CC+} - 0.003$		V
			Low level		0.080	0.180	
$I_{CC}$	Supply current	LPV321			4	8	$\mu\text{A}$
		LPV358 (both amplifiers)			8	16	
		LPV324 (all four amplifiers)			16	24	
SR	Slew rate‡				0.1		V/ $\mu\text{s}$
GBW	Gain bandwidth product	$C_L = 22\text{ pF}$ (see Note 5)			205		kHz
$\Phi_m$	Phase margin	$C_L = 22\text{ pF}$ (see Note 5)			71		deg
	Gain margin	$C_L = 22\text{ pF}$ (see Note 5)			11		dB
$V_n$	Equivalent input noise voltage	$f = 1\text{ kHz}$			178		$\text{nV}/\sqrt{\text{Hz}}$
$I_n$	Equivalent input noise current	$f = 1\text{ kHz}$			0.5		$\text{pA}/\sqrt{\text{Hz}}$

† All typical values are at  $V_{CC} = 2.7\text{ V}$ ,  $T_A = 25^\circ\text{C}$ .

‡ Number specified is the slower of the positive and negative slew rates.

NOTE 5: Closed-loop gain = 18 dB,  $V_{IC} = V_{CC+}/2$

# LPV321 SINGLE, LPV358 DUAL, LPV324 QUAD GENERAL-PURPOSE, LOW-VOLTAGE, LOW-POWER, RAIL-TO-RAIL OUTPUT OPERATIONAL AMPLIFIERS

SLOS433I – FEBRUARY 2004 – REVISED MARCH 2005

**5-V electrical characteristics** $T_A = 25^\circ\text{C}$ ,  $V_{CC+} = 5\text{ V}$ ,  $V_{CC-} = 0\text{ V}$ ,  $V_{IC} = 2\text{ V}$ ,  $V_O = V_{CC+}/2$ , and  $R_L > 1\text{ M}\Omega$  (unless otherwise noted)

PARAMETER	TEST CONDITIONS	$T_A$	MIN	TYP†	MAX	UNIT	
$V_{IO}$ Input offset voltage		25°C		1.5	7	mV	
		-40°C to 85°C			10		
		-40°C to 125°C			11		
$\alpha_{VIO}$ Average temperature coefficient of input offset voltage		25°C		4		$\mu\text{V}/^\circ\text{C}$	
$I_{IB}$ Input bias current		25°C		2	50	nA	
		-40°C to 85°C			60		
		-40°C to 125°C			65		
CMRR Common-mode rejection ratio	$0 \leq V_{IC} \leq 4\text{ V}$	25°C	50	71		dB	
$k_{SVR}$ Supply-voltage rejection ratio	$2.7\text{ V} \leq V_{CC+} \leq 5\text{ V}$ , $V_{IC} = 1\text{ V}$ , $V_O = 1\text{ V}$	25°C	50	65		dB	
$V_{ICR}$ Common-mode input voltage range	CMRR $\geq 50\text{ dB}$	25°C	0 to 4	-0.2 to 4.2		V	
$I_{IO}$ Input offset current		25°C		0.6	40	nA	
		-40°C to 85°C			50		
		-40°C to 125°C			55		
$V_O$ Output swing	$R_L = 100\text{ k}\Omega$ to $2.5\text{ V}$	High level	25°C	$V_{CC+} - 0.100$	$V_{CC+} - 0.0035$	V	
			-40°C to 85°C	$V_{CC+} - 0.200$			
			-40°C to 125°C	$V_{CC+} - 0.225$			
		Low level	25°C		0.090		0.180
			-40°C to 85°C				0.220
			-40°C to 125°C				0.240
$I_{OS}$ Output short-circuit current	Sourcing, $V_O = 0\text{ V}$	25°C	2	17	mA		
	Sinking, $V_O = 5\text{ V}$		20	72			
$I_{CC}$ Supply current	LPV321	25°C		9	12	$\mu\text{A}$	
		-40°C to 85°C			15		
		-40°C to 125°C			40		
	LPV358 (both amplifiers)	25°C		15	20		
		-40°C to 85°C			24		
		-40°C to 125°C			80		
	LPV324 (all four amplifiers)	25°C		28	42		
		-40°C to 85°C			46		
		-40°C to 125°C			125		
$A_V^\ddagger$ Large-signal voltage gain	$R_L = 100\text{ k}\Omega$	25°C	15	100	V/mV		
		-40°C to 85°C	10				
		-40°C to 125°C	10				
SR $^\S$ Slew rate		25°C		0.1		V/ $\mu\text{s}$	

† All typical values are at  $V_{CC} = 5\text{ V}$ ,  $T_A = 25^\circ\text{C}$ .‡  $R_L$  is connected to  $V_{CC-}$ . The output voltage is  $0.5\text{ V} \leq V_O \leq 4.5\text{ V}$ .

§ Number specified is the slower of the positive and negative slew rates. Connected as a voltage follower with 3-V step input.

# LPV321 SINGLE, LPV358 DUAL, LPV324 QUAD GENERAL-PURPOSE, LOW-VOLTAGE, LOW-POWER, RAIL-TO-RAIL OUTPUT OPERATIONAL AMPLIFIERS

SLOS433I – FEBRUARY 2004 – REVISED MARCH 2005

**5-V electrical characteristics**

$T_A = 25^\circ\text{C}$ ,  $V_{CC+} = 5\text{ V}$ ,  $V_{CC-} = 0\text{ V}$ ,  $V_{IC} = 2\text{ V}$ ,  $V_O = V_{CC+}/2$ , and  $R_L > 1\text{ M}\Omega$  (unless otherwise noted)  
(continued)

PARAMETER		TEST CONDITIONS	$T_A$	MIN	TYP <sup>†</sup>	MAX	UNIT
GBW	Gain bandwidth product	$C_L = 22\text{ pF}$ (see Note 5)	$25^\circ\text{C}$		237		kHz
$\Phi_m$	Phase margin	$C_L = 22\text{ pF}$ (see Note 5)	$25^\circ\text{C}$		74		deg
	Gain margin	$C_L = 22\text{ pF}$ (see Note 5)	$25^\circ\text{C}$		12		dB
$V_n$	Equivalent input noise voltage	$f = 1\text{ kHz}$	$25^\circ\text{C}$		146		$\text{nV}/\sqrt{\text{Hz}}$
$I_n$	Equivalent input noise current	$f = 1\text{ kHz}$	$25^\circ\text{C}$		0.3		$\text{pA}/\sqrt{\text{Hz}}$

<sup>†</sup> All typical values are at  $V_{CC} = 5\text{ V}$ ,  $T_A = 25^\circ\text{C}$ .

NOTE 5: Closed-loop gain = 18 dB,  $V_{IC} = V_{CC+}/2$

**LPV321 SINGLE, LPV358 DUAL, LPV324 QUAD  
GENERAL-PURPOSE, LOW-VOLTAGE, LOW-POWER, RAIL-TO-RAIL OUTPUT  
OPERATIONAL AMPLIFIERS**

SLOS433I – FEBRUARY 2004 – REVISED MARCH 2005

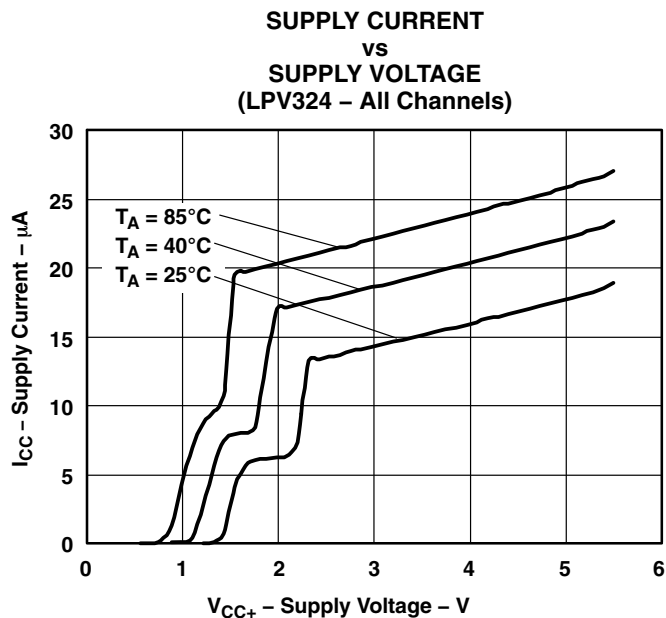

Figure 1

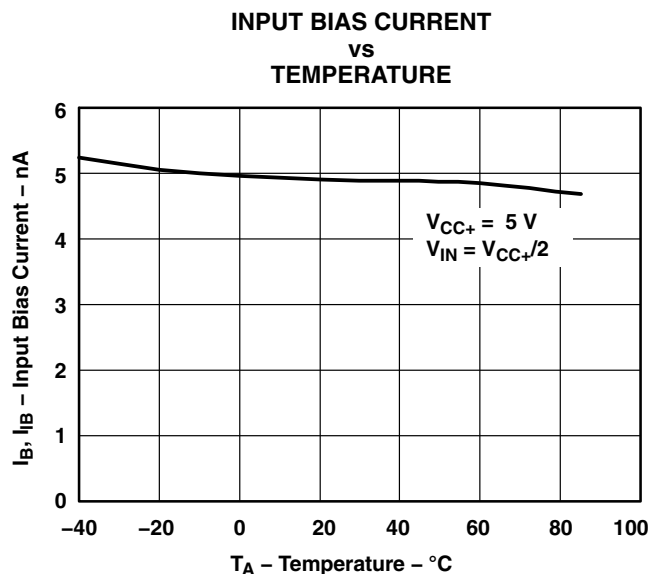

Figure 2

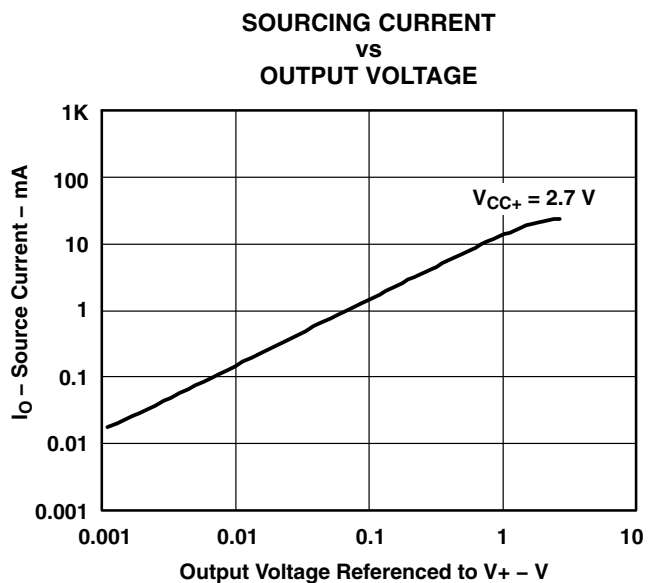

Figure 3

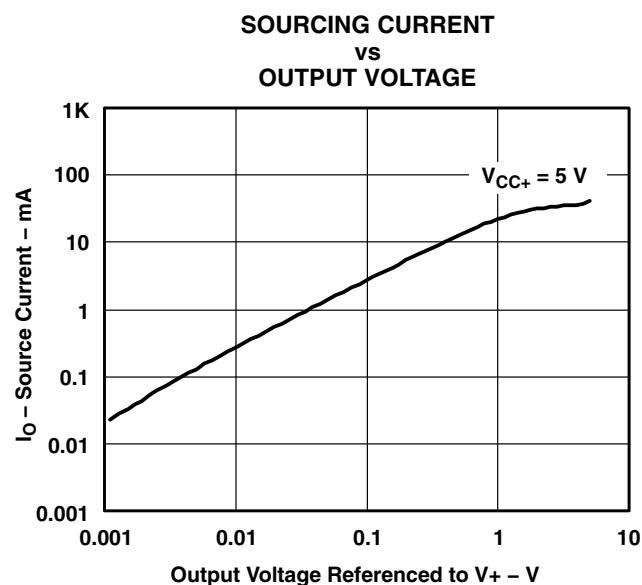

Figure 4

LPV321 SINGLE, LPV358 DUAL, LPV324 QUAD  
 GENERAL-PURPOSE, LOW-VOLTAGE, LOW-POWER, RAIL-TO-RAIL OUTPUT  
 OPERATIONAL AMPLIFIERS

SLOS433I – FEBRUARY 2004 – REVISED MARCH 2005

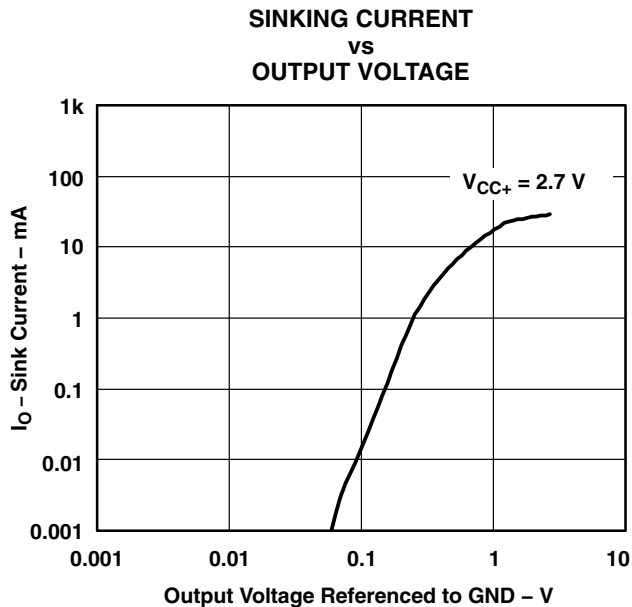

Figure 5

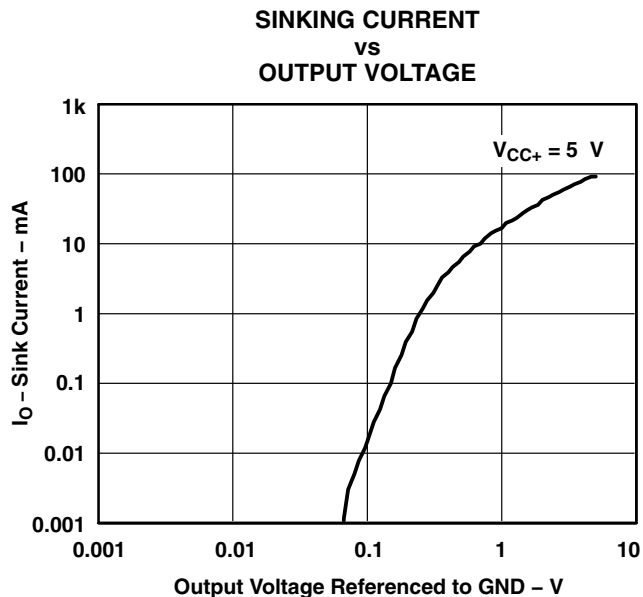

Figure 6

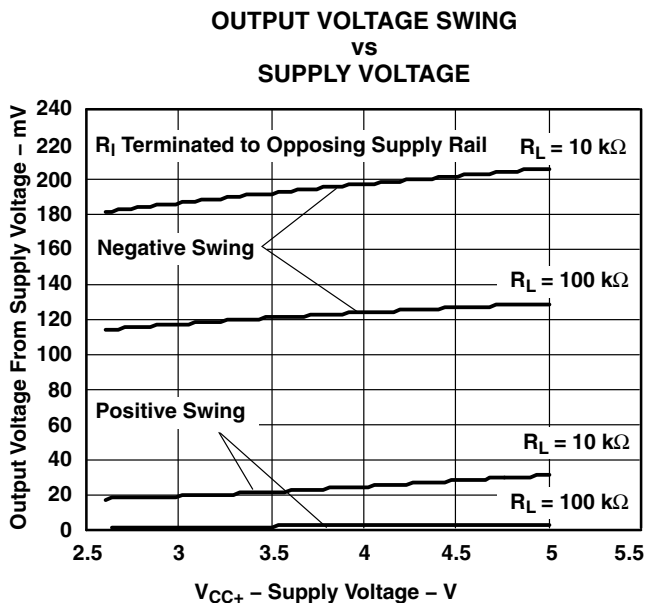

Figure 7

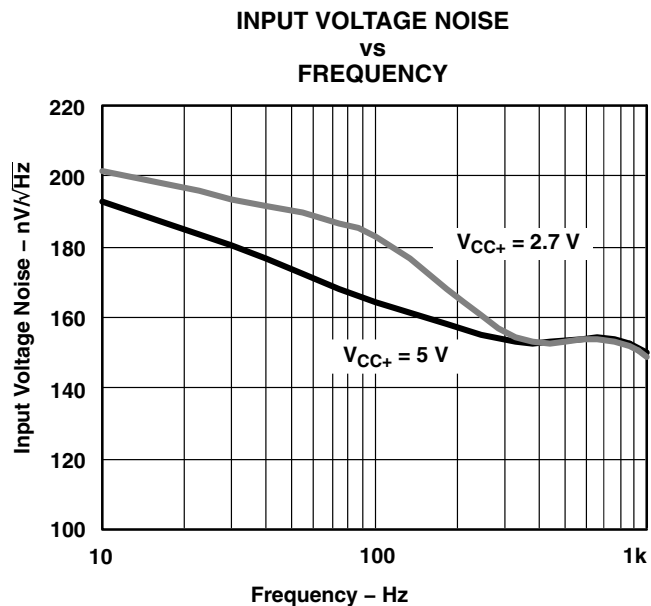

Figure 8

# LPV321 SINGLE, LPV358 DUAL, LPV324 QUAD GENERAL-PURPOSE, LOW-VOLTAGE, LOW-POWER, RAIL-TO-RAIL OUTPUT OPERATIONAL AMPLIFIERS

SLOS433I – FEBRUARY 2004 – REVISED MARCH 2005

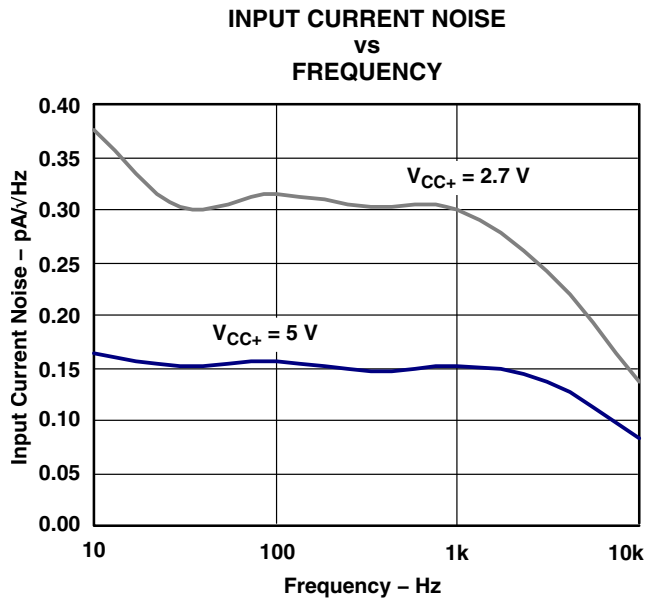

Figure 9

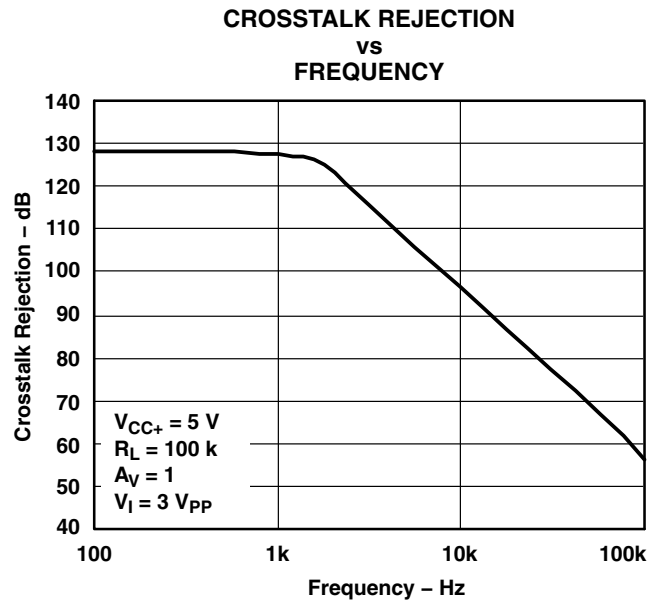

Figure 10

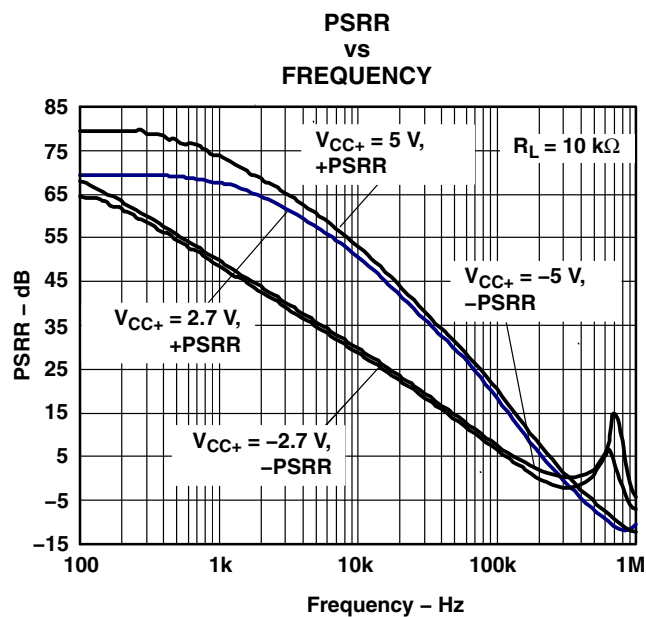

Figure 11

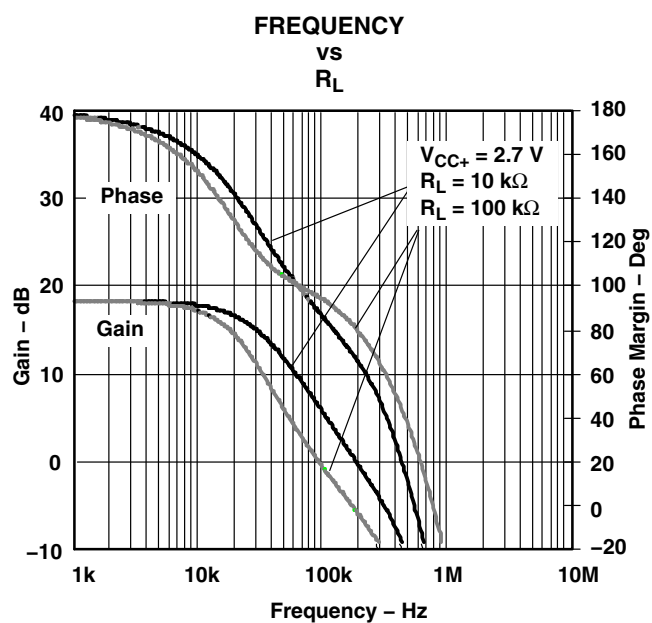

Figure 12

# LPV321 SINGLE, LPV358 DUAL, LPV324 QUAD GENERAL-PURPOSE, LOW-VOLTAGE, LOW-POWER, RAIL-TO-RAIL OUTPUT OPERATIONAL AMPLIFIERS

SLOS433I – FEBRUARY 2004 – REVISED MARCH 2005

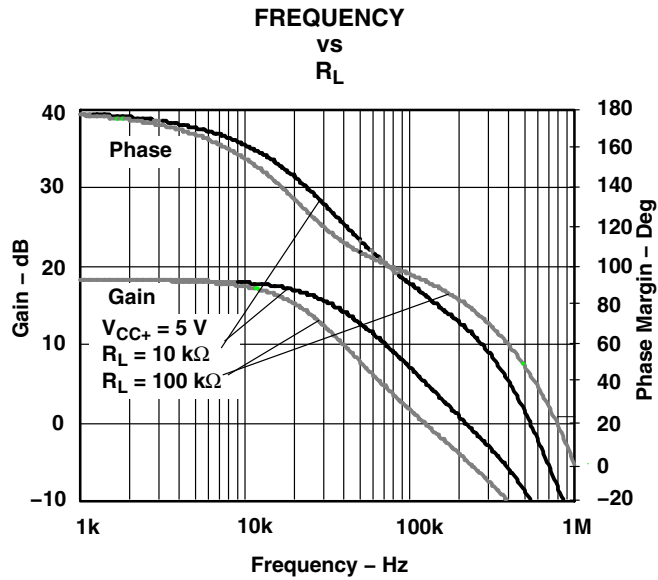

Figure 13

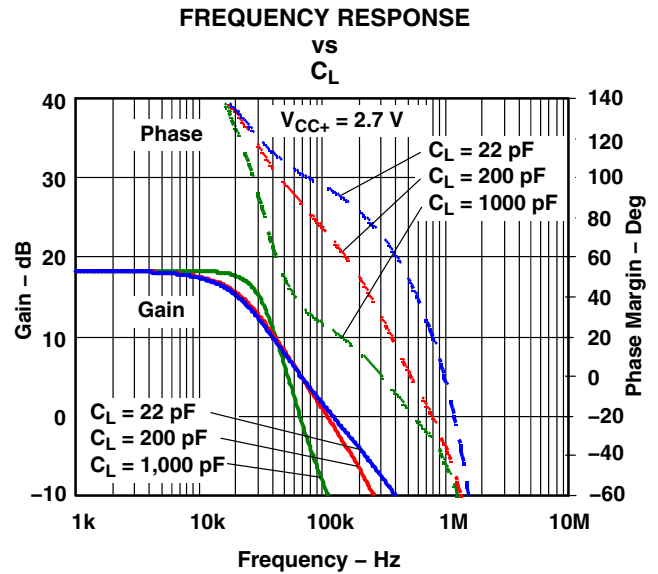

Figure 14

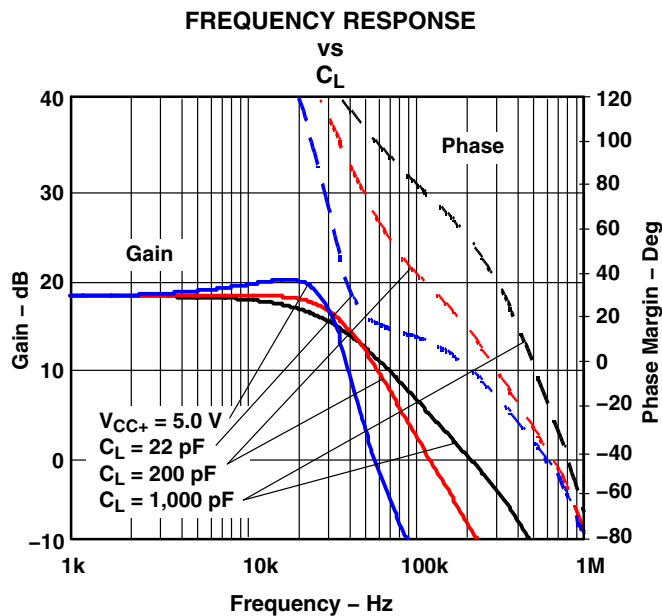

Figure 15

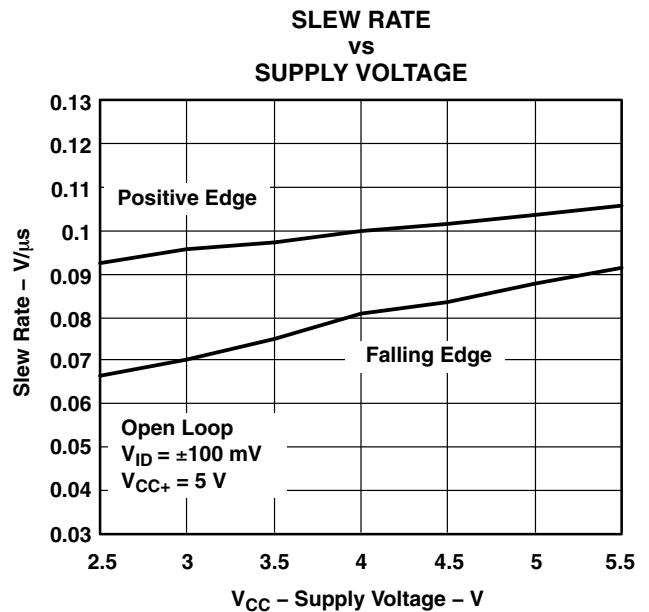

Figure 16

# LPV321 SINGLE, LPV358 DUAL, LPV324 QUAD GENERAL-PURPOSE, LOW-VOLTAGE, LOW-POWER, RAIL-TO-RAIL OUTPUT OPERATIONAL AMPLIFIERS

SLOS433I – FEBRUARY 2004 – REVISED MARCH 2005

NONINVERTING LARGE-SIGNAL PULSE RESPONSE

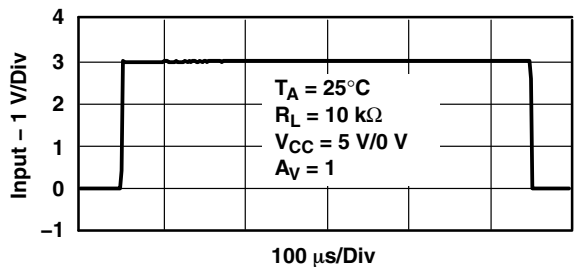

Figure 17

NONINVERTING SMALL-SIGNAL PULSE RESPONSE

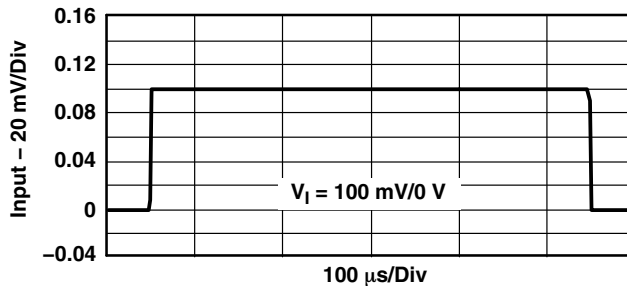

Figure 18

INVERTING LARGE-SIGNAL PULSE RESPONSE

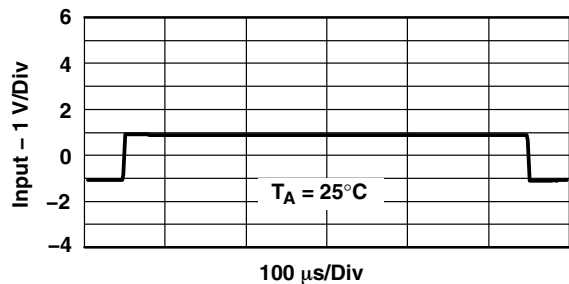

Figure 19

INVERTING SMALL-SIGNAL PULSE RESPONSE

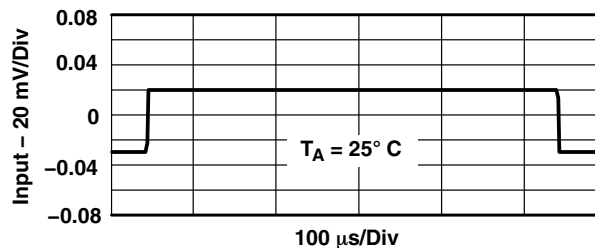
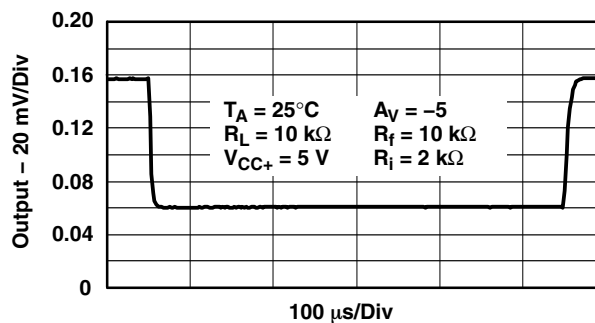
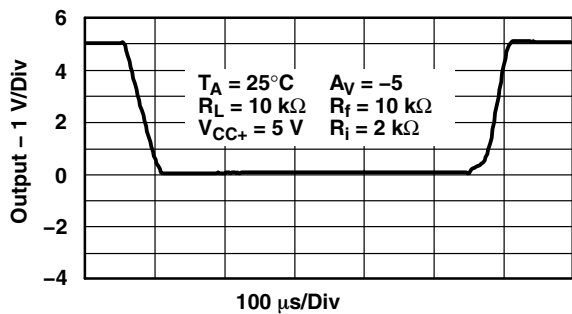

Figure 20



**PACKAGING INFORMATION**

Orderable Device	Status (1)	Package Type	Package Drawing	Pins	Package Qty	Eco Plan (2)	Lead/Ball Finish (6)	MSL Peak Temp (3)	Op Temp (°C)	Device Marking (4/5)	Samples
LPV321DBVR	OBSOLETE	SOT-23	DBV	5		TBD	Call TI	Call TI	-40 to 85	(5C7B ~ 5C7I)	
LPV321DBVRE4	OBSOLETE	SOT-23	DBV	5		TBD	Call TI	Call TI	-40 to 85		
LPV321DBVRG4	OBSOLETE	SOT-23	DBV	5		TBD	Call TI	Call TI	-40 to 85		
LPV321DCKR	OBSOLETE	SC70	DCK	5		TBD	Call TI	Call TI	-40 to 85	(52B ~ 52I)	
LPV321DCKRE4	OBSOLETE	SC70	DCK	5		TBD	Call TI	Call TI	-40 to 85		
LPV321DCKRG4	OBSOLETE	SC70	DCK	5		TBD	Call TI	Call TI	-40 to 85		
LPV321IDBVR	OBSOLETE	SOT-23	DBV	5		TBD	Call TI	Call TI	-40 to 125	(5C1B ~ 5C1I)	
LPV321IDBVRE4	OBSOLETE	SOT-23	DBV	5		TBD	Call TI	Call TI	-40 to 125		
LPV321IDBVRG4	OBSOLETE	SOT-23	DBV	5		TBD	Call TI	Call TI	-40 to 125		
LPV321IDCKR	OBSOLETE	SC70	DCK	5		TBD	Call TI	Call TI	-40 to 125	(53B ~ 53I)	
LPV321IDCKRE4	OBSOLETE	SC70	DCK	5		TBD	Call TI	Call TI	-40 to 125		
LPV321IDCKRG4	OBSOLETE	SC70	DCK	5		TBD	Call TI	Call TI	-40 to 125		
LPV324D	OBSOLETE	SOIC	D	14		TBD	Call TI	Call TI	-40 to 85	LPV324	
LPV324DE4	OBSOLETE	SOIC	D	14		TBD	Call TI	Call TI	-40 to 85		
LPV324DG4	OBSOLETE	SOIC	D	14		TBD	Call TI	Call TI	-40 to 85		
LPV324DR	OBSOLETE	SOIC	D	14		TBD	Call TI	Call TI	-40 to 85	LPV324	
LPV324DRE4	OBSOLETE	SOIC	D	14		TBD	Call TI	Call TI	-40 to 85		
LPV324DRG4	OBSOLETE	SOIC	D	14		TBD	Call TI	Call TI	-40 to 85		
LPV324ID	OBSOLETE	SOIC	D	14		TBD	Call TI	Call TI	-40 to 125	LPV324I	
LPV324IDE4	OBSOLETE	SOIC	D	14		TBD	Call TI	Call TI	-40 to 125		
LPV324IDG4	OBSOLETE	SOIC	D	14		TBD	Call TI	Call TI	-40 to 125		
LPV324IDR	OBSOLETE	SOIC	D	14		TBD	Call TI	Call TI	-40 to 125	LPV324I	
LPV324IDRE4	OBSOLETE	SOIC	D	14		TBD	Call TI	Call TI	-40 to 125		
LPV324IDRG4	OBSOLETE	SOIC	D	14		TBD	Call TI	Call TI	-40 to 125		
LPV324IPW	OBSOLETE	TSSOP	PW	14		TBD	Call TI	Call TI	-40 to 125	PV324I	
LPV324IPWE4	OBSOLETE	TSSOP	PW	14		TBD	Call TI	Call TI	-40 to 125		
LPV324IPWG4	OBSOLETE	TSSOP	PW	14		TBD	Call TI	Call TI	-40 to 125		
LPV324IPWR	OBSOLETE	TSSOP	PW	14		TBD	Call TI	Call TI	-40 to 125	PV324I	
LPV324IPWRE4	OBSOLETE	TSSOP	PW	14		TBD	Call TI	Call TI	-40 to 125		
LPV324IPWRG4	OBSOLETE	TSSOP	PW	14		TBD	Call TI	Call TI	-40 to 125		

Orderable Device	Status (1)	Package Type	Package Drawing	Pins	Package Qty	Eco Plan (2)	Lead/Ball Finish (6)	MSL Peak Temp (3)	Op Temp (°C)	Device Marking (4/5)	Samples
LPV324PW	OBSOLETE	TSSOP	PW	14		TBD	Call TI	Call TI	-40 to 85	PV324	
LPV324PWE4	OBSOLETE	TSSOP	PW	14		TBD	Call TI	Call TI	-40 to 85		
LPV324PWG4	OBSOLETE	TSSOP	PW	14		TBD	Call TI	Call TI	-40 to 85		
LPV324PWR	OBSOLETE	TSSOP	PW	14		TBD	Call TI	Call TI	-40 to 85	PV324	
LPV324PWRE4	OBSOLETE	TSSOP	PW	14		TBD	Call TI	Call TI	-40 to 85		
LPV324PWRG4	OBSOLETE	TSSOP	PW	14		TBD	Call TI	Call TI	-40 to 85		
LPV358D	OBSOLETE	SOIC	D	8		TBD	Call TI	Call TI	-40 to 85	PV358	
LPV358DDUR	OBSOLETE	VSSOP	DDU	8		TBD	Call TI	Call TI	-40 to 85	5A56	
LPV358DDURE4	OBSOLETE	VSSOP	DDU	8		TBD	Call TI	Call TI	-40 to 85		
LPV358DDURG4	OBSOLETE	VSSOP	DDU	8		TBD	Call TI	Call TI	-40 to 85		
LPV358DE4	OBSOLETE	SOIC	D	8		TBD	Call TI	Call TI	-40 to 85		
LPV358DG4	OBSOLETE	SOIC	D	8		TBD	Call TI	Call TI	-40 to 85		
LPV358DGKR	OBSOLETE	VSSOP	DGK	8		TBD	Call TI	Call TI	-40 to 85	546	
LPV358DGKRG4	OBSOLETE	VSSOP	DGK	8		TBD	Call TI	Call TI	-40 to 85		
LPV358DR	OBSOLETE	SOIC	D	8		TBD	Call TI	Call TI	-40 to 85	PV358	
LPV358DRE4	OBSOLETE	SOIC	D	8		TBD	Call TI	Call TI	-40 to 85		
LPV358DRG4	OBSOLETE	SOIC	D	8		TBD	Call TI	Call TI	-40 to 85		
LPV358ID	OBSOLETE	SOIC	D	8		TBD	Call TI	Call TI	-40 to 125	PV358I	
LPV358IDDUR	OBSOLETE	VSSOP	DDU	8		TBD	Call TI	Call TI	-40 to 125	5AE6	
LPV358IDDURE4	OBSOLETE	VSSOP	DDU	8		TBD	Call TI	Call TI	-40 to 125		
LPV358IDDURG4	OBSOLETE	VSSOP	DDU	8		TBD	Call TI	Call TI	-40 to 125		
LPV358IDE4	OBSOLETE	SOIC	D	8		TBD	Call TI	Call TI	-40 to 125		
LPV358IDG4	OBSOLETE	SOIC	D	8		TBD	Call TI	Call TI	-40 to 125		
LPV358IDGKR	OBSOLETE	VSSOP	DGK	8		TBD	Call TI	Call TI	-40 to 125	556	
LPV358IDGKRG4	OBSOLETE	VSSOP	DGK	8		TBD	Call TI	Call TI	-40 to 125		
LPV358IDR	OBSOLETE	SOIC	D	8		TBD	Call TI	Call TI	-40 to 125	PV358I	
LPV358IDRE4	OBSOLETE	SOIC	D	8		TBD	Call TI	Call TI	-40 to 125		
LPV358IDRG4	OBSOLETE	SOIC	D	8		TBD	Call TI	Call TI	-40 to 125		

(1) The marketing status values are defined as follows:

**ACTIVE:** Product device recommended for new designs.

**LIFEBUY:** TI has announced that the device will be discontinued, and a lifetime-buy period is in effect.

**NRND:** Not recommended for new designs. Device is in production to support existing customers, but TI does not recommend using this part in a new design.

---

**PREVIEW:** Device has been announced but is not in production. Samples may or may not be available.

**OBSOLETE:** TI has discontinued the production of the device.

<sup>(2)</sup> Eco Plan - The planned eco-friendly classification: Pb-Free (RoHS), Pb-Free (RoHS Exempt), or Green (RoHS & no Sb/Br) - please check <http://www.ti.com/productcontent> for the latest availability information and additional product content details.

**TBD:** The Pb-Free/Green conversion plan has not been defined.

**Pb-Free (RoHS):** TI's terms "Lead-Free" or "Pb-Free" mean semiconductor products that are compatible with the current RoHS requirements for all 6 substances, including the requirement that lead not exceed 0.1% by weight in homogeneous materials. Where designed to be soldered at high temperatures, TI Pb-Free products are suitable for use in specified lead-free processes.

**Pb-Free (RoHS Exempt):** This component has a RoHS exemption for either 1) lead-based flip-chip solder bumps used between the die and package, or 2) lead-based die adhesive used between the die and leadframe. The component is otherwise considered Pb-Free (RoHS compatible) as defined above.

**Green (RoHS & no Sb/Br):** TI defines "Green" to mean Pb-Free (RoHS compatible), and free of Bromine (Br) and Antimony (Sb) based flame retardants (Br or Sb do not exceed 0.1% by weight in homogeneous material)

<sup>(3)</sup> MSL, Peak Temp. - The Moisture Sensitivity Level rating according to the JEDEC industry standard classifications, and peak solder temperature.

<sup>(4)</sup> There may be additional marking, which relates to the logo, the lot trace code information, or the environmental category on the device.

<sup>(5)</sup> Multiple Device Markings will be inside parentheses. Only one Device Marking contained in parentheses and separated by a "~" will appear on a device. If a line is indented then it is a continuation of the previous line and the two combined represent the entire Device Marking for that device.

<sup>(6)</sup> Lead/Ball Finish - Orderable Devices may have multiple material finish options. Finish options are separated by a vertical ruled line. Lead/Ball Finish values may wrap to two lines if the finish value exceeds the maximum column width.

**Important Information and Disclaimer:** The information provided on this page represents TI's knowledge and belief as of the date that it is provided. TI bases its knowledge and belief on information provided by third parties, and makes no representation or warranty as to the accuracy of such information. Efforts are underway to better integrate information from third parties. TI has taken and continues to take reasonable steps to provide representative and accurate information but may not have conducted destructive testing or chemical analysis on incoming materials and chemicals. TI and TI suppliers consider certain information to be proprietary, and thus CAS numbers and other limited information may not be available for release.

In no event shall TI's liability arising out of such information exceed the total purchase price of the TI part(s) at issue in this document sold by TI to Customer on an annual basis.

DBV (R-PDSO-G5)

PLASTIC SMALL-OUTLINE PACKAGE



- NOTES:
- A. All linear dimensions are in millimeters.
  - B. This drawing is subject to change without notice.
  - C. Body dimensions do not include mold flash or protrusion. Mold flash and protrusion shall not exceed 0.15 per side.
  - D. Falls within JEDEC MO-178 Variation AA.

DCK (R-PDSO-G5)

PLASTIC SMALL-OUTLINE PACKAGE



- NOTES:
- A. All linear dimensions are in millimeters.
  - B. This drawing is subject to change without notice.
  - C. Body dimensions do not include mold flash or protrusion. Mold flash and protrusion shall not exceed 0.15 per side.
  - D. Falls within JEDEC MO-203 variation AA.

DGK (S-PDSO-G8)

PLASTIC SMALL-OUTLINE PACKAGE

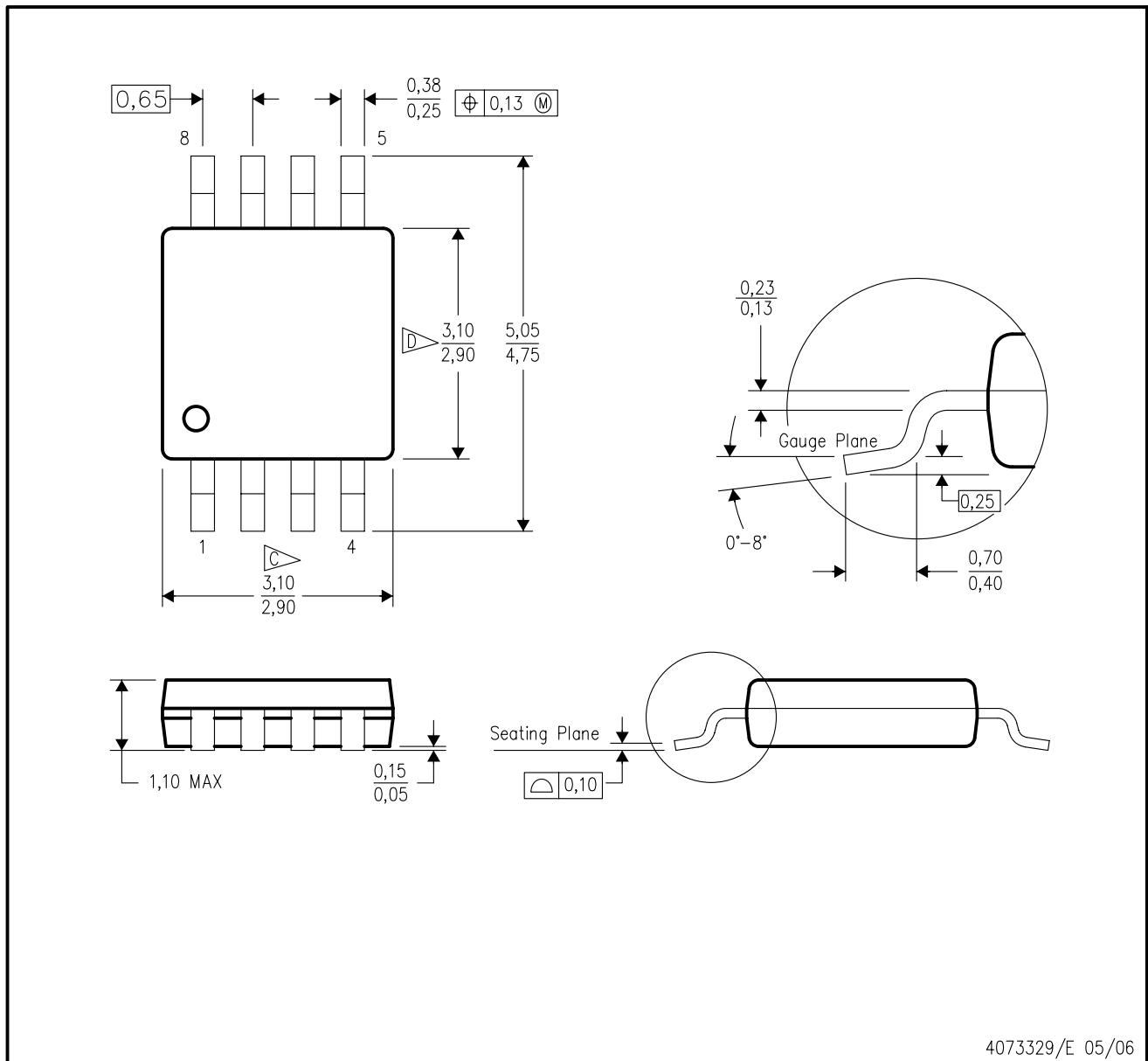

- NOTES:
- A. All linear dimensions are in millimeters.
  - B. This drawing is subject to change without notice.
  - C. Body length does not include mold flash, protrusions, or gate burrs. Mold flash, protrusions, or gate burrs shall not exceed 0.15 per end.
  - D. Body width does not include interlead flash. Interlead flash shall not exceed 0.50 per side.
  - E. Falls within JEDEC MO-187 variation AA, except interlead flash.



D (R-PDSO-G14)

PLASTIC SMALL OUTLINE

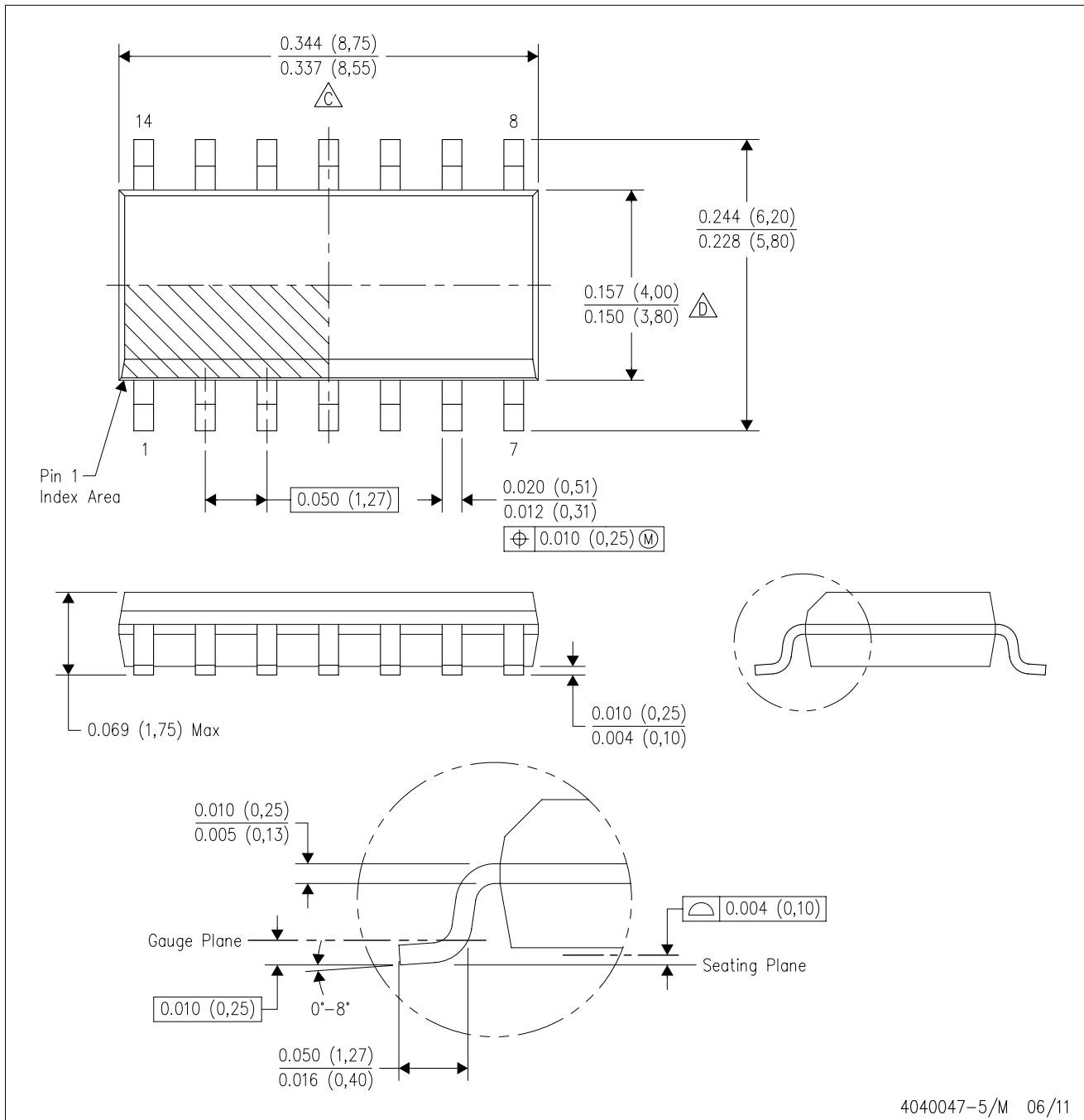

- NOTES:
- A. All linear dimensions are in inches (millimeters).
  - B. This drawing is subject to change without notice.
  -  Body length does not include mold flash, protrusions, or gate burrs. Mold flash, protrusions, or gate burrs shall not exceed 0.006 (0,15) each side.
  -  Body width does not include interlead flash. Interlead flash shall not exceed 0.017 (0,43) each side.
  - E. Reference JEDEC MS-012 variation AB.

PW (R-PDSO-G14)

PLASTIC SMALL OUTLINE

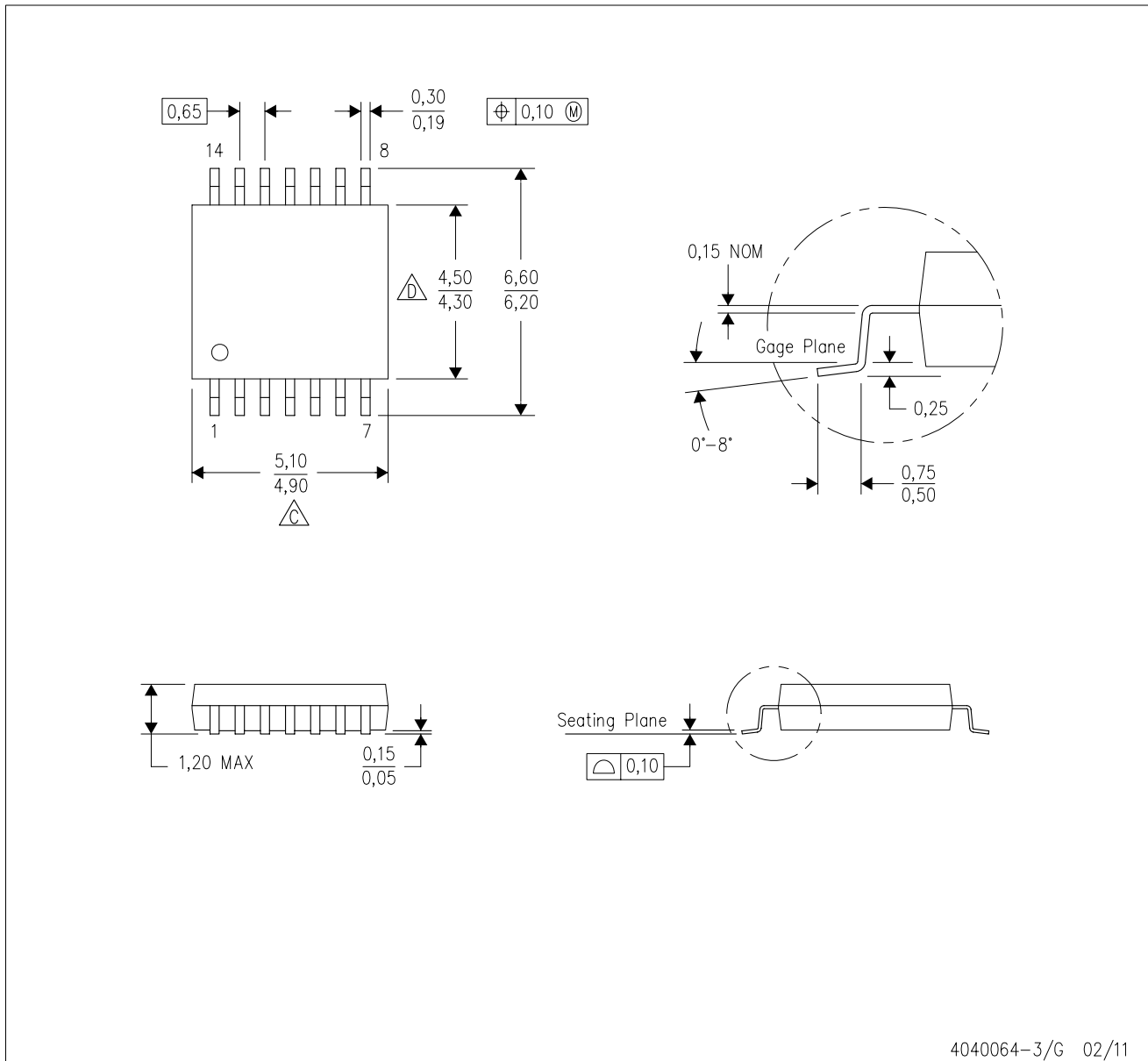

4040064-3/G 02/11

- NOTES:
- A. All linear dimensions are in millimeters. Dimensioning and tolerancing per ASME Y14.5M-1994.
  - B. This drawing is subject to change without notice.
  - C. Body length does not include mold flash, protrusions, or gate burrs. Mold flash, protrusions, or gate burrs shall not exceed 0,15 each side.
  - D. Body width does not include interlead flash. Interlead flash shall not exceed 0,25 each side.
  - E. Falls within JEDEC MO-153

D (R-PDSO-G8)

PLASTIC SMALL OUTLINE

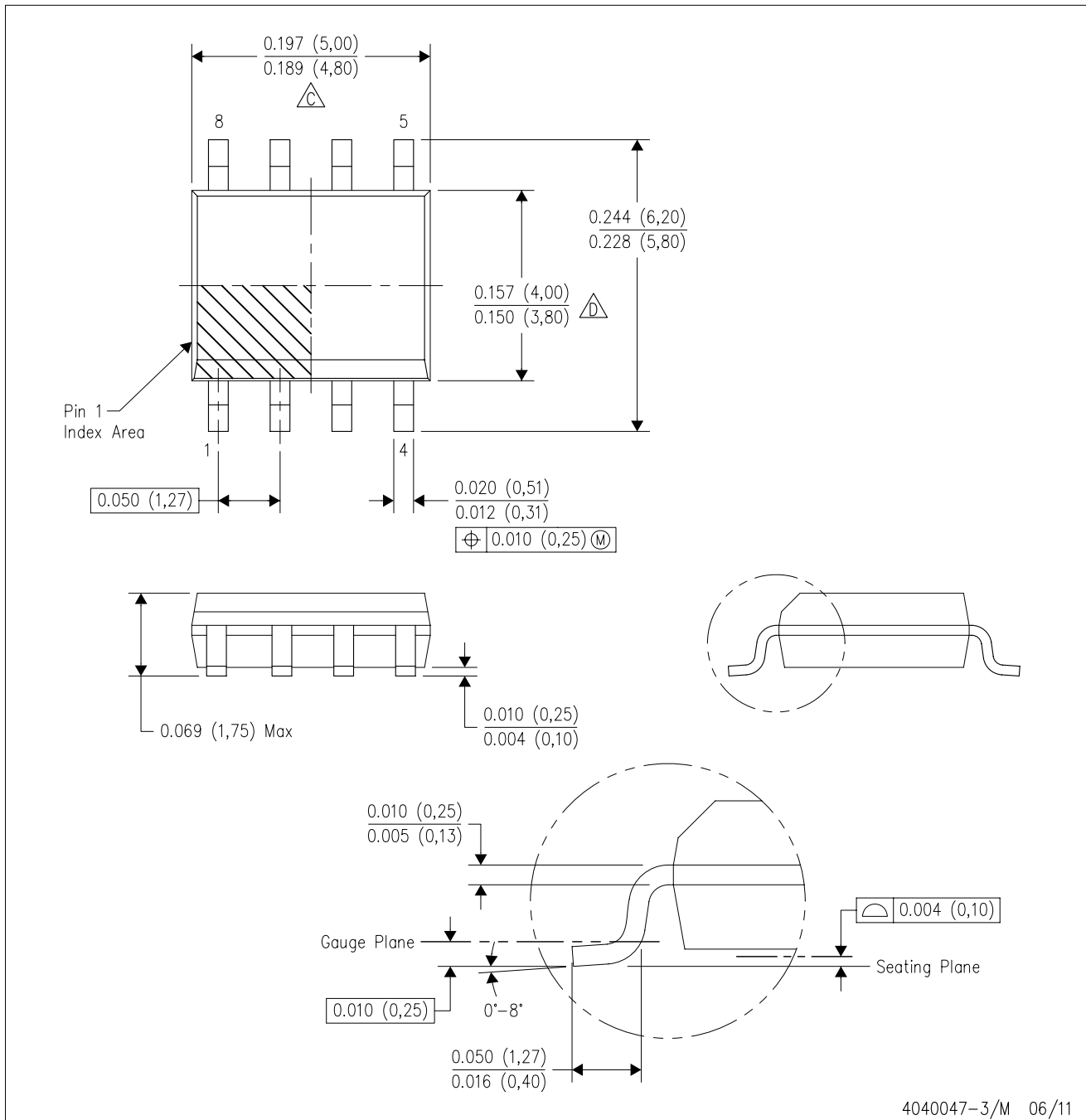

- NOTES:
- A. All linear dimensions are in inches (millimeters).
  - B. This drawing is subject to change without notice.
  - C. Body length does not include mold flash, protrusions, or gate burrs. Mold flash, protrusions, or gate burrs shall not exceed 0.006 (0,15) each side.
  - D. Body width does not include interlead flash. Interlead flash shall not exceed 0.017 (0,43) each side.
  - E. Reference JEDEC MS-012 variation AA.

## IMPORTANT NOTICE

Texas Instruments Incorporated and its subsidiaries (TI) reserve the right to make corrections, enhancements, improvements and other changes to its semiconductor products and services per JESD46, latest issue, and to discontinue any product or service per JESD48, latest issue. Buyers should obtain the latest relevant information before placing orders and should verify that such information is current and complete. All semiconductor products (also referred to herein as "components") are sold subject to TI's terms and conditions of sale supplied at the time of order acknowledgment.

TI warrants performance of its components to the specifications applicable at the time of sale, in accordance with the warranty in TI's terms and conditions of sale of semiconductor products. Testing and other quality control techniques are used to the extent TI deems necessary to support this warranty. Except where mandated by applicable law, testing of all parameters of each component is not necessarily performed.

TI assumes no liability for applications assistance or the design of Buyers' products. Buyers are responsible for their products and applications using TI components. To minimize the risks associated with Buyers' products and applications, Buyers should provide adequate design and operating safeguards.

TI does not warrant or represent that any license, either express or implied, is granted under any patent right, copyright, mask work right, or other intellectual property right relating to any combination, machine, or process in which TI components or services are used. Information published by TI regarding third-party products or services does not constitute a license to use such products or services or a warranty or endorsement thereof. Use of such information may require a license from a third party under the patents or other intellectual property of the third party, or a license from TI under the patents or other intellectual property of TI.

Reproduction of significant portions of TI information in TI data books or data sheets is permissible only if reproduction is without alteration and is accompanied by all associated warranties, conditions, limitations, and notices. TI is not responsible or liable for such altered documentation. Information of third parties may be subject to additional restrictions.

Resale of TI components or services with statements different from or beyond the parameters stated by TI for that component or service voids all express and any implied warranties for the associated TI component or service and is an unfair and deceptive business practice. TI is not responsible or liable for any such statements.

Buyer acknowledges and agrees that it is solely responsible for compliance with all legal, regulatory and safety-related requirements concerning its products, and any use of TI components in its applications, notwithstanding any applications-related information or support that may be provided by TI. Buyer represents and agrees that it has all the necessary expertise to create and implement safeguards which anticipate dangerous consequences of failures, monitor failures and their consequences, lessen the likelihood of failures that might cause harm and take appropriate remedial actions. Buyer will fully indemnify TI and its representatives against any damages arising out of the use of any TI components in safety-critical applications.

In some cases, TI components may be promoted specifically to facilitate safety-related applications. With such components, TI's goal is to help enable customers to design and create their own end-product solutions that meet applicable functional safety standards and requirements. Nonetheless, such components are subject to these terms.

No TI components are authorized for use in FDA Class III (or similar life-critical medical equipment) unless authorized officers of the parties have executed a special agreement specifically governing such use.

Only those TI components which TI has specifically designated as military grade or "enhanced plastic" are designed and intended for use in military/aerospace applications or environments. Buyer acknowledges and agrees that any military or aerospace use of TI components which have **not** been so designated is solely at the Buyer's risk, and that Buyer is solely responsible for compliance with all legal and regulatory requirements in connection with such use.

TI has specifically designated certain components as meeting ISO/TS16949 requirements, mainly for automotive use. In any case of use of non-designated products, TI will not be responsible for any failure to meet ISO/TS16949.

### Products

Audio	<a href="http://www.ti.com/audio">www.ti.com/audio</a>
Amplifiers	<a href="http://amplifier.ti.com">amplifier.ti.com</a>
Data Converters	<a href="http://dataconverter.ti.com">dataconverter.ti.com</a>
DLP® Products	<a href="http://www.dlp.com">www.dlp.com</a>
DSP	<a href="http://dsp.ti.com">dsp.ti.com</a>
Clocks and Timers	<a href="http://www.ti.com/clocks">www.ti.com/clocks</a>
Interface	<a href="http://interface.ti.com">interface.ti.com</a>
Logic	<a href="http://logic.ti.com">logic.ti.com</a>
Power Mgmt	<a href="http://power.ti.com">power.ti.com</a>
Microcontrollers	<a href="http://microcontroller.ti.com">microcontroller.ti.com</a>
RFID	<a href="http://www.ti-rfid.com">www.ti-rfid.com</a>
OMAP Applications Processors	<a href="http://www.ti.com/omap">www.ti.com/omap</a>
Wireless Connectivity	<a href="http://www.ti.com/wirelessconnectivity">www.ti.com/wirelessconnectivity</a>

### Applications

Automotive and Transportation	<a href="http://www.ti.com/automotive">www.ti.com/automotive</a>
Communications and Telecom	<a href="http://www.ti.com/communications">www.ti.com/communications</a>
Computers and Peripherals	<a href="http://www.ti.com/computers">www.ti.com/computers</a>
Consumer Electronics	<a href="http://www.ti.com/consumer-apps">www.ti.com/consumer-apps</a>
Energy and Lighting	<a href="http://www.ti.com/energy">www.ti.com/energy</a>
Industrial	<a href="http://www.ti.com/industrial">www.ti.com/industrial</a>
Medical	<a href="http://www.ti.com/medical">www.ti.com/medical</a>
Security	<a href="http://www.ti.com/security">www.ti.com/security</a>
Space, Avionics and Defense	<a href="http://www.ti.com/space-avionics-defense">www.ti.com/space-avionics-defense</a>
Video and Imaging	<a href="http://www.ti.com/video">www.ti.com/video</a>

### TI E2E Community

[e2e.ti.com](http://e2e.ti.com)

## Looking for pricing, stock, or lifecycle information?

Click below to explore more details on WIN SOURCE:

 [View LPV358DGKRG4](#) on WIN SOURCE

 [Texas Instruments](#) Information

## Optimize Your Supply Chain with WIN SOURCE Solutions

-  Global Sourcing Solution
-  Obsolete Management
-  Cost Control Management
-  Shortage Management
-  Alternative Solution
-  Excess Inventory Management