



THE DATASHEET OF MPS-30-12





■ Features :

- Universal AC input / Full range
- Low leakage current <200μA
- Protections: Short circuit / Overload / Over voltage / Over temperature
- Medical safety approved (2 x MOPP between primary to secondary)
- Fixed switching frequency at 100KHz
- Low cost
- High reliability
- 3 years warranty



SPECIFICATION

MODEL	MPS-30-5	MPS-30-12	MPS-30-15	MPS-30-24	MPS-30-27	MPS-30-48	
OUTPUT	DC VOLTAGE	5V	12V	15V	24V	27V	48V
	RATED CURRENT	5A	2.5A	2A	1.2A	1.1A	0.6A
	CURRENT RANGE	0 ~ 5A	0 ~ 2.5A	0 ~ 2A	0 ~ 1.2A	0 ~ 1.1A	0 ~ 0.6A
	RATED POWER	25W	30W	30W	28.8W	29.7W	28.8W
	RIPPLE & NOISE (max.) Note.2	80mVp-p	120mVp-p	150mVp-p	240mVp-p	240mVp-p	240mVp-p
	VOLTAGE TOLERANCE Note.3	± 3.0%	± 3.0%	± 3.0%	± 3.0%	± 3.0%	± 2.0%
	LINE REGULATION	± 1.0%	± 1.0%	± 0.5%	± 0.5%	± 0.5%	± 0.5%
	LOAD REGULATION	± 2.0%	± 1.0%	± 1.0%	± 1.0%	± 1.0%	± 1.0%
	SETUP, RISE TIME	500ms, 30ms/230VAC 500ms, 30ms/115VAC at full load					
HOLD UP TIME (Typ.)	70ms/230VAC 12ms/115VAC at full load						
INPUT	VOLTAGE RANGE	88 ~ 264VAC auto switch 120 ~ 370VDC					
	FREQUENCY RANGE	47 ~ 63Hz					
	EFFICIENCY (Typ.)	72%	75%	76%	77%	78%	78%
	AC CURRENT (Typ.)	0.8A/115VAC 0.5A/230VAC					
	INRUSH CURRENT (Typ.)	COLD START 30A/230VAC					
LEAKAGE CURRENT	Earth leakage current < 200μA/264VAC						
PROTECTION	OVERLOAD	Above 105% rated output power Protection type : Hiccup mode, recovers automatically after fault condition is removed					
	OVER VOLTAGE	5.5 ~ 6.75V	13.2 ~ 16.2V	16.5 ~ 20.25V	26.4 ~ 32.4V	29.7 ~ 36.45V	52.8 ~ 64.8V
	OVER TEMPERATURE	Shut down o/p voltage, re-power on to recover					
ENVIRONMENT	WORKING TEMP.	-10 ~ +60°C (Refer to "Derating Curve")					
	WORKING HUMIDITY	20 ~ 90% RH non-condensing					
	STORAGE TEMP., HUMIDITY	-20 ~ +85°C, 10 ~ 95% RH					
	TEMP. COEFFICIENT	± 0.03%/°C (0 ~ 50°C)					
VIBRATION	10 ~ 500Hz, 2G 10min./1cycle, period for 60min. each along X, Y, Z axes						
SAFETY & EMC (Note 4)	SAFETY STANDARDS	ANSI/AAMI ES60601-1, TUV EN60601-1, IEC60601-1 approved					
	ISOLATION LEVEL	Primary-Secondary: 2xMOPP, Primary-Earth:1xMOPP					
	WITHSTAND VOLTAGE	I/P-O/P:4KVAC I/P-FG:2KVAC O/P-FG:SHORT					
	ISOLATION RESISTANCE	I/P-O/P, I/P-FG:100M Ohms / 500VDC / 25°C / 70% RH					
	EMC EMISSION	Compliance to EN55011 (CISPR11) Class B, EN61000-3-2,-3					
EMC IMMUNITY	Compliance to EN61000-4-2,3,4,5,6,8,11, EN55024, EN60601-1-2, medical level, criteria A						
OTHERS	MTBF	547Khrs min. MIL-HDBK-217F (25°C)					
	DIMENSION	101.6*65.8*23.5mm (L*W*H)					
	PACKING	0.16Kg; 90pcs/15.8Kg/1.06CUFT					
NOTE	<p>1. All parameters NOT specially mentioned are measured at 230VAC input, rated load and 25°C of ambient temperature.</p> <p>2. Ripple & noise are measured at 20MHz of bandwidth by using a 12" twisted pair-wire terminated with a 0.1uf & 47uf parallel capacitor.</p> <p>3. Tolerance : includes set up tolerance, line regulation and load regulation.</p> <p>4. The power supply is considered a component which will be installed into a final equipment. All the EMC tests are been executed by mounting the unit on a 360mm*360mm metal plate with 1mm of thickness. The final equipment must be re-confirmed that it still meets EMC directives. For guidance on how to perform these EMC tests, please refer to "EMI testing of component power supplies." (as available on http://www.meanwell.com)</p> <p>5. When the input voltage is less than 40VAC, the SPS may exhibit degradation of performance. The final product manufacturers must re-confirm this deviation that does not affect basic safety or essential performance.</p> <p>※ Product Liability Disclaimer : For detailed information, please refer to https://www.meanwell.com/serviceDisclaimer.aspx</p>						

■ Mechanical Specification

Unit:mm

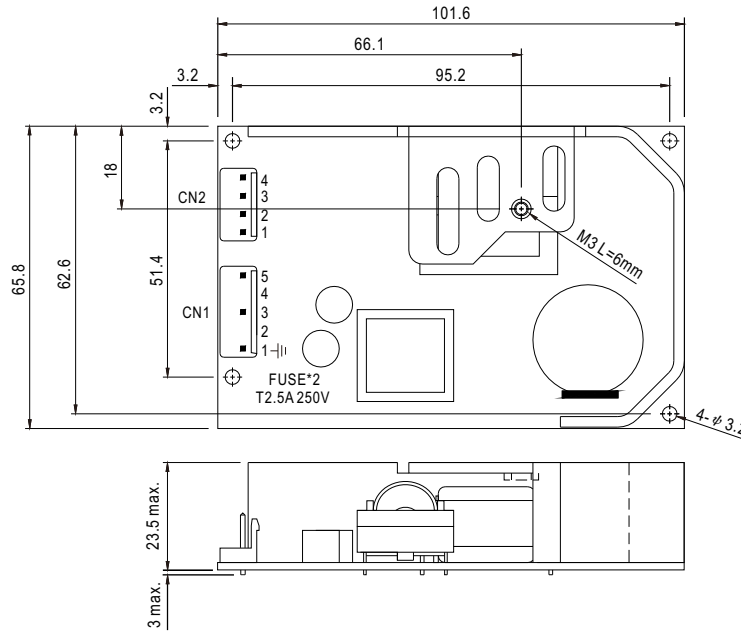

AC Input Connector (CN1) : Molex 41791-5 or equivalent

Pin No.	Assignment	Mating Housing	Terminal
1	FG \perp	Molex 2139 or equivalent	Molex 2478 or equivalent
2,4	No Pin		
3	AC/N		
5	AC/L		

\perp : Grounding Required
CN1:Pin 1 is safety ground

DC Output Connector (CN2) : Molex 41791-4 or equivalent

Pin No.	Assignment	Mating Housing	Terminal
1,2	-V	Molex 2139 or equivalent	Molex 2478 or equivalent
3,4	+V		

■ Block Diagram

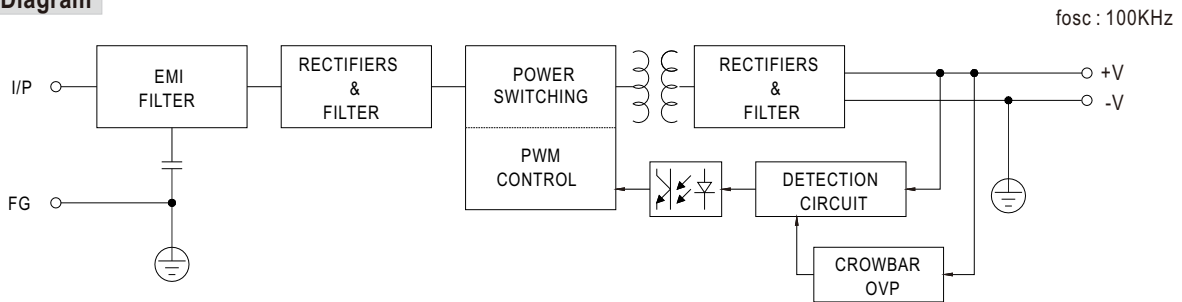

■ Derating Curve

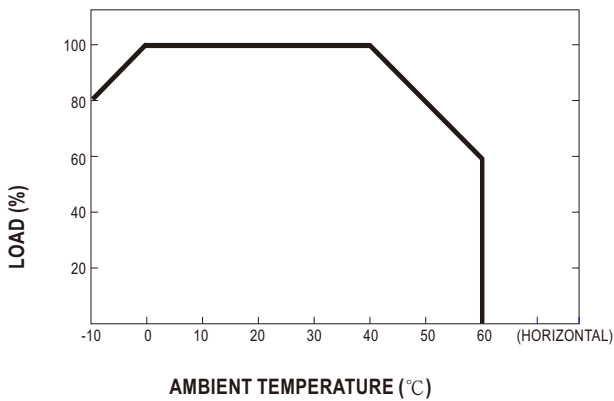

■ Static Characteristics

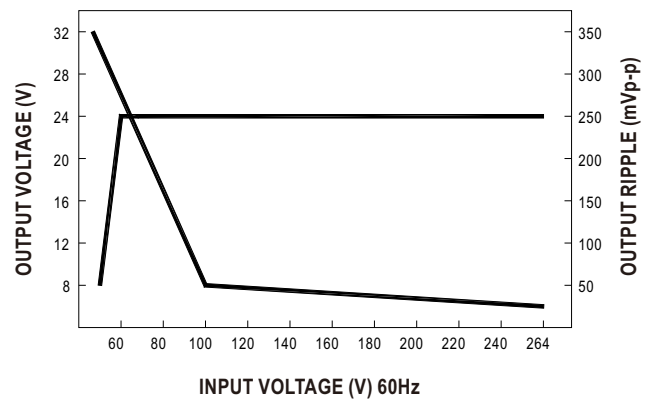

Looking for pricing, stock, or lifecycle information?

Click below to explore more details on WIN SOURCE:

- [View MPS-30-12 on WIN SOURCE](#)
- [Mean Well Enterprises Co., Ltd. Information](#)

Optimize Your Supply Chain with WIN SOURCE Solutions

- ✓ Global Sourcing Solution
- ✓ Obsolete Management
- ✓ Cost Control Management
- ✓ Shortage Management
- ✓ Alternative Solution
- ✓ Excess Inventory Management