



**THE DATASHEET OF
AMN44122**



1

What is a Motion Sensor?

The motion sensor is an infrared human detection sensor, which, as opposed to factory automation sensors that are used with factory equipment, is designed to be incorporated into various devices that exist around us in daily life.

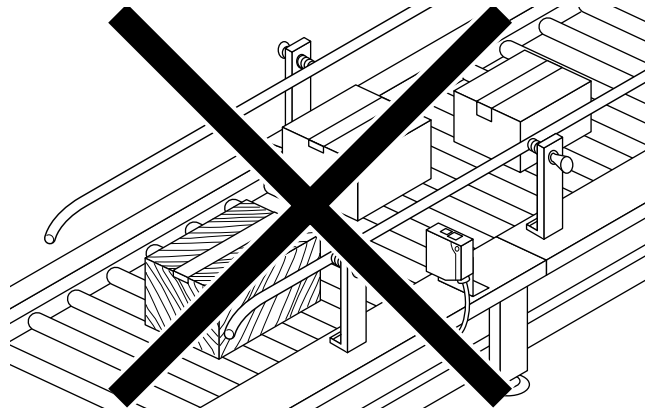

Motion sensors are not for use in factory automation.

Types of motion sensor

Motion sensors are divided into two types.

Passive infrared type

Designed to cover a wide area, this sensor detects human presence. The sensor, rather than emitting light such as from LEDs, detects the amount of change in infrared rays that occurs when a person (object), whose temperature is different from the surroundings, moves.

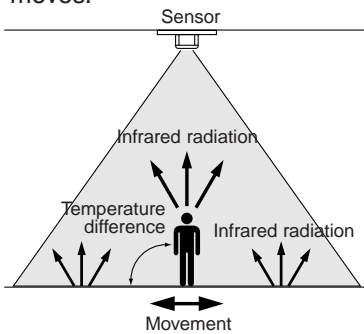

1. As this sensor detects temperature differences, it is well suited to detecting the motion of people by their body temperature.
2. Wide sensing area.
3. Detection distance cannot be set.

The world's smallest with a built-in amplifier MP Motion Sensor 'N a P i 0 n'

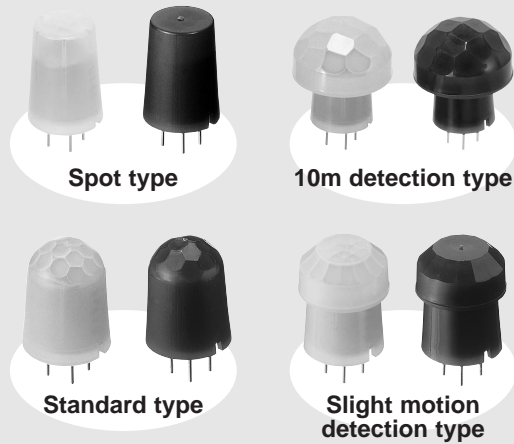

Area reflective type

As the name implies this sensor emits infrared rays from an LED. Using the reflection of those rays the sensor measures the distance to the person (object) and detects whether or not it exists within a specific distance.

- (1) Suitable for detection within specific ranges.
- (2) Possible to select the detection distance.
 - Selection possible in 1 cm increments between 5 cm and 10 cm.
 - Selection possible in 10 cm increments between 20 cm and 200 cm.

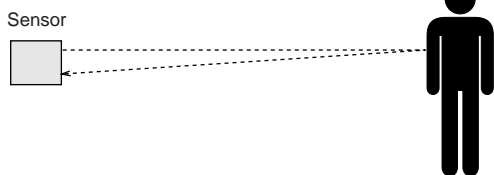

A compact distance-type sensor that is not easily influenced by reflection ratio.

MA Motion Sensor

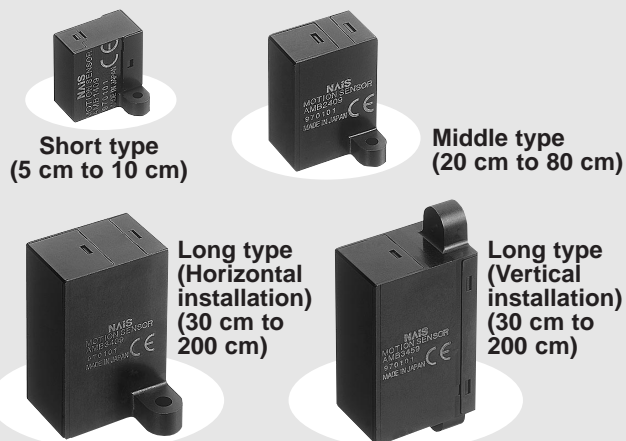

1.What is a Motion Sensor?

Application of MP Motion Sensor ' N a P i 0 n '

Automatically turn indoor lighting on and off



Method of use

Use as a human detection sensor to automatically turn lights on when a person is present in a room and to turn them off when nobody is there.

Points to consider when selecting a sensor

1. The presence of a person must be detected over a side area (room).
2. Even slight human motion must be detected.



MP Motion Sensor

Other application examples

Recommended conditions of use

1. Detection over a wide area (see note).
2. When the detection range extends to the wall or floor.

Note: If you wish to limit the range of detection, we recommended a spot type sensor.

Conference room control sensor

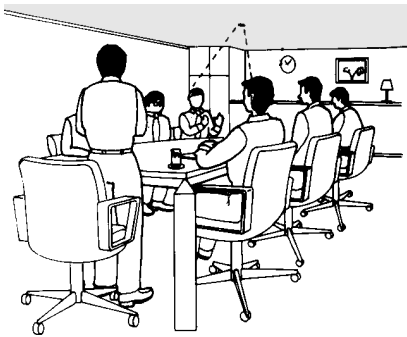

Automatic verbal address system

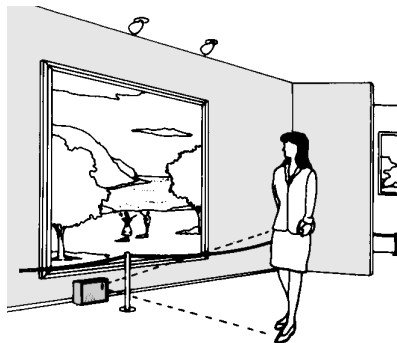

Lighting control for vending machine

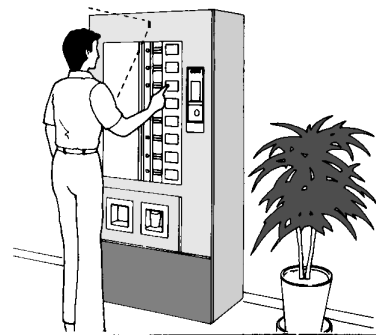

Amusement park facilities: Automatic control of devices (Establishes timing for device start-up).



Monitor camera

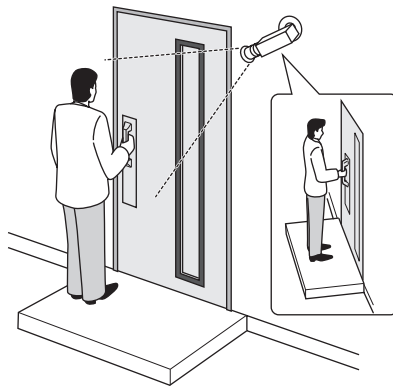

Control of air conditioner louver

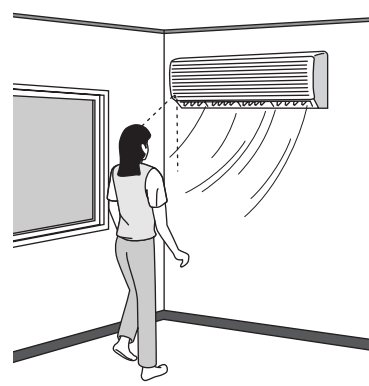

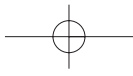
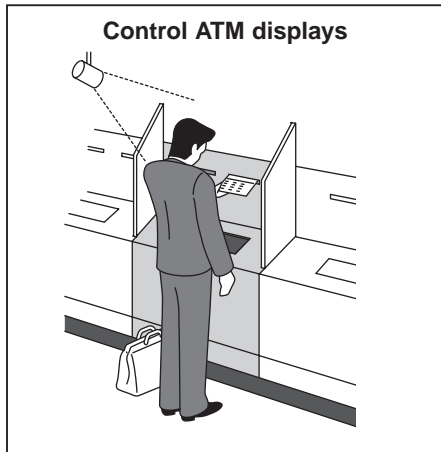
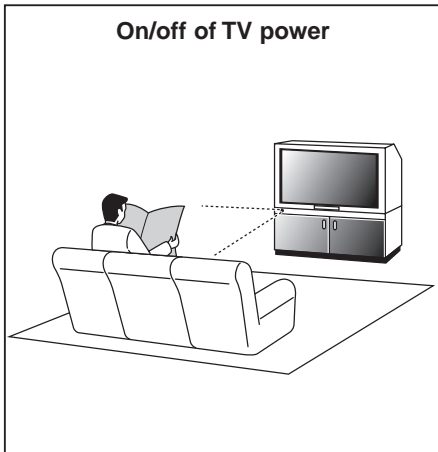
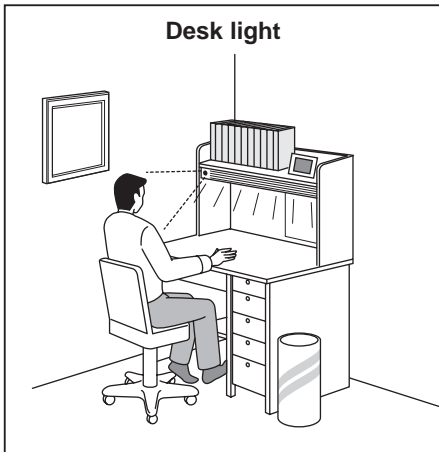
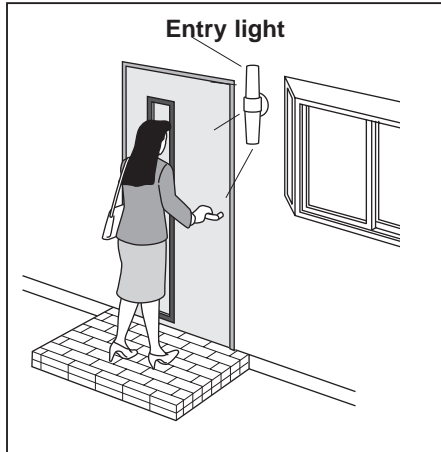
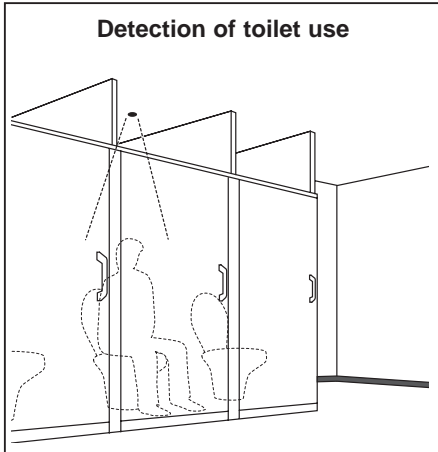
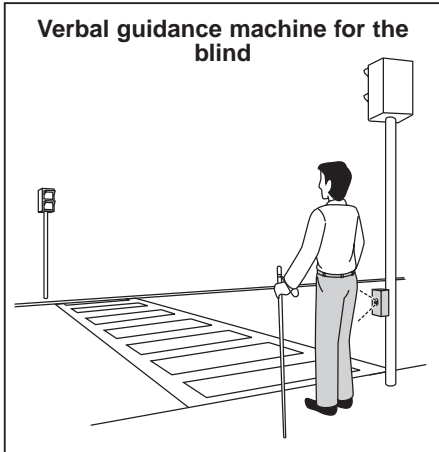
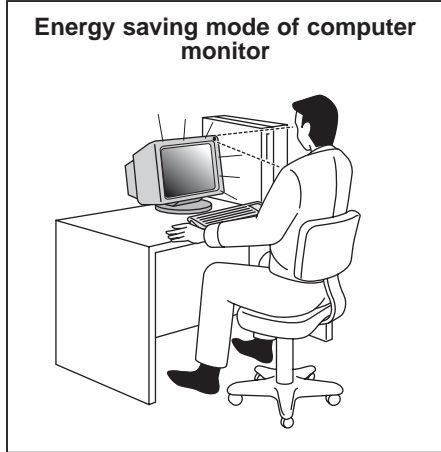
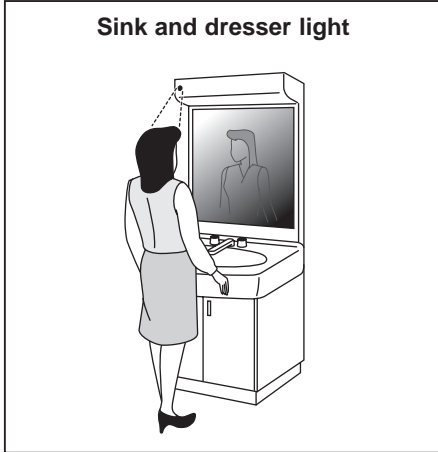
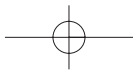

Application of MA Motion Sensor

Running machine in athletic club

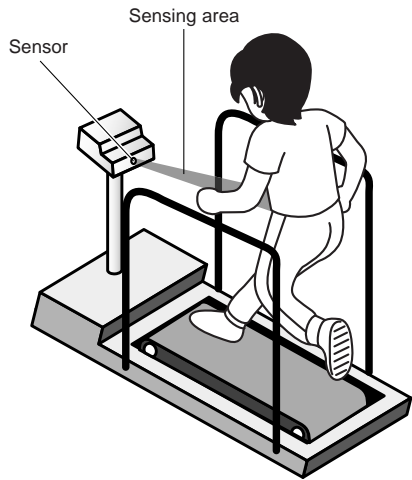

Method of use

To prevent the runner from falling when he or she tires and becomes unable to keep up with the belt, the sensor slows the belt when the runner falls back out of the detection area of the sensor.

Points to consider when selecting a sensor

1. The detection area must be limited so that only the person using the running machine is detected.
2. The detection distance must be limited.



MA Motion Sensor

Other application examples

Recommended conditions of use

1. Non-moving people (objects) and objects without a temperature difference are to be detected.
2. The detection distance and area must be limited (see note).

Note: With the aim of widening the detection range, the external trigger type, which prevents reciprocal interference, is recommended when using multiple sensors.

<p>Automatic water faucets</p>	<p>Non-contact switch for the toilet</p> <p>Toilet seat opening & closing control Lighting control Flushing switch</p>	<p>Customer detecting sensors for automated teller machines</p>
<p>Customer sensor</p>	<p>Automatic ticket gate</p>	<p>Parking meter</p>

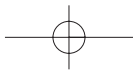

Application example

Select a sensor that suits the objective.

Examples of automatic advertising and automatic verbal guidance (ticket machines, vending machines, ATMs, illuminated photographs, etc.)

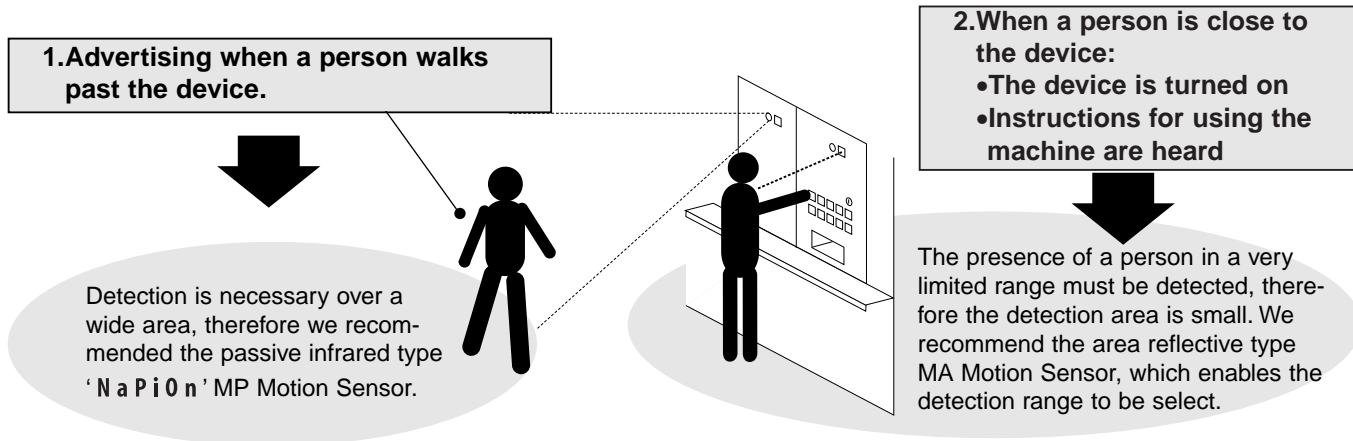

The current situation:

Techniques for reducing device power consumption will increase dramatically.

To preserve the global environment

At the Kyoto conference for the prevention of global warming held in 1997, it was agreed that "by 2008–2012, Japan will attempt to reduce the output of greenhouse gases by 6% with respect to 1990 levels."

Efforts in various fields to reduce greenhouse gases

Environmental action:

The beginning of "energy-saving" competition

Government

From the latter half of 1998 to the former half of 1999, the Ministry of International Trade and Industry began enforcement of the Energy Saving Act, which requires manufacturers to conserve energy.

The focal point of this act is the "Top Runner Method", whereby "Excellent products" having the highest energy efficiency are selected. This energy efficiency becomes a standard that other products are required to meet within a certain period. Manufacturers unable to meet this standard are subject to punishment. A total of ten products are scheduled for implementation, including automobiles and electrical appliances such as air conditioners, refrigerators, televisions, VCRs, and personal computers.

Manufacturers

"Energy saving" is becoming an increasingly important factor in consumer selection of products. Manufacturers are therefore promoting their technical prowess and aggressive stance with respect to environmental problems.

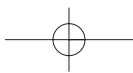

1. What is a Motion Sensor?

Following marks behind each application.

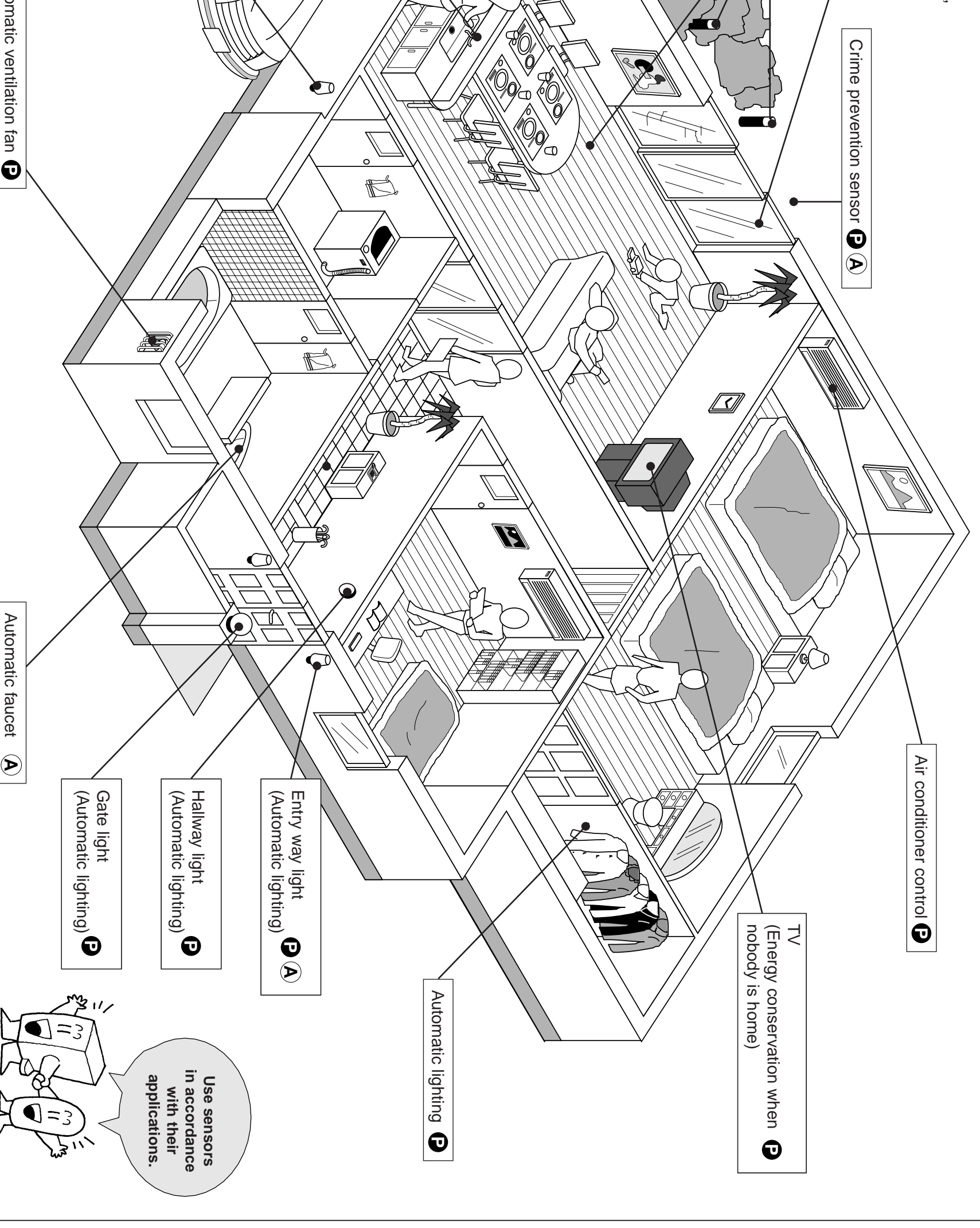

Following marks behind each

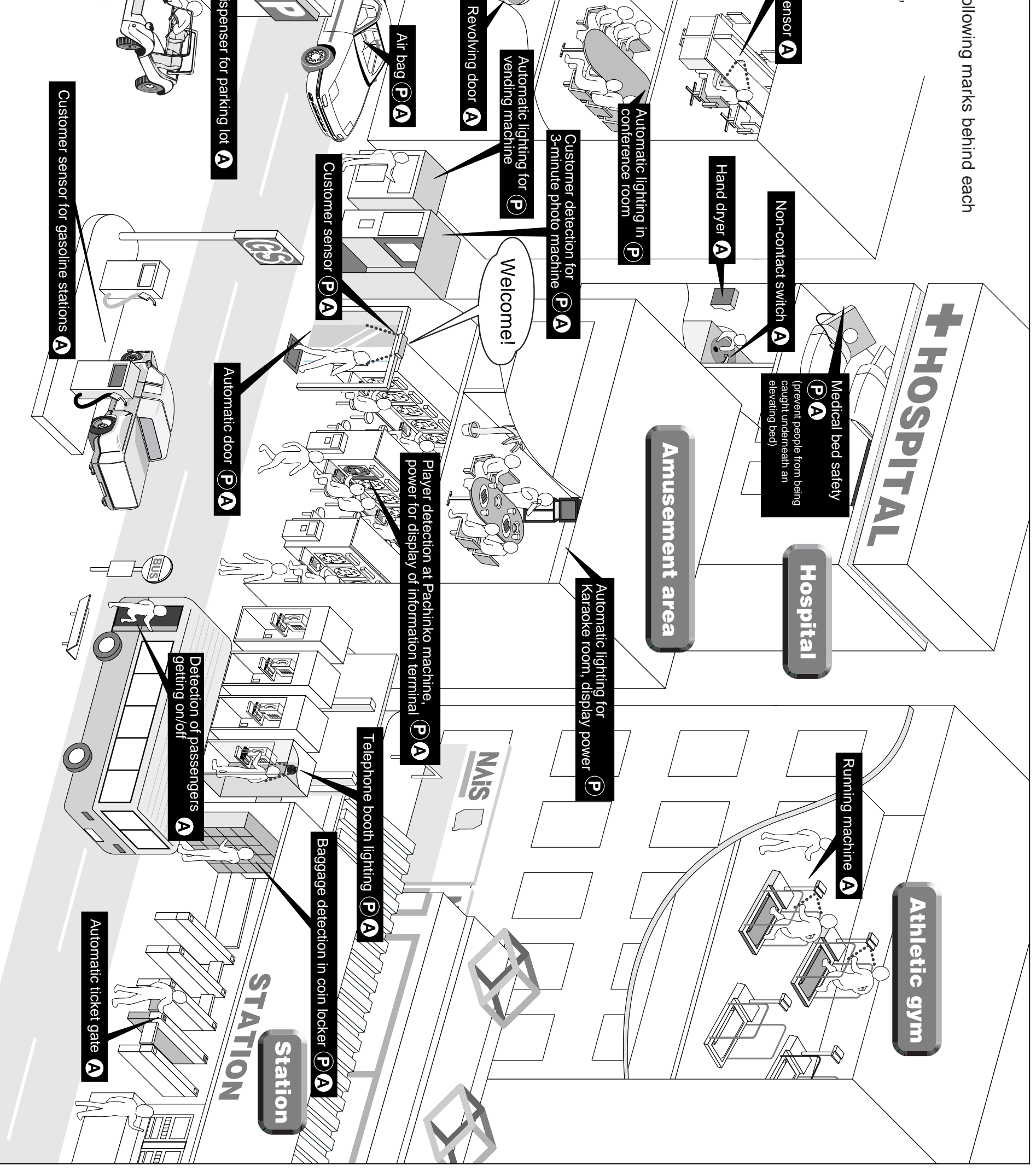

1. What is a Motion Sensor?

2 Operating principle of Motion Sensor

MP Motion Sensor 'NaPiOn'

Overall, from the standpoint of detection performance, noise resistance, causes of false detection and cost performance, the passive infrared type is the most practical means of detecting the human body without contact.

All objects on the earth emit light in accordance with their temperature and surface characteristics. Naturally, light (infrared radiation) is also emitted from our bodies. (This radiation is emitted from the body surface, and is centered around a wave-length of $10\mu\text{m}$.)
When a person enters the detection area of the sensor, the amount of infrared radiation incident on the sensor varies by the amount corresponding to the difference in temperature between the body surface and background.

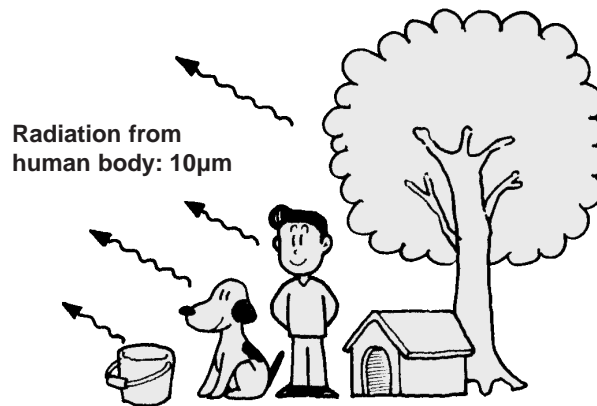

These sensors detect the human body by detecting the change in incident infrared radiation.

That is, the sensor is actuated by the difference in temperature between human body (which is a heat source) and floor, walls and other objects forming the background.

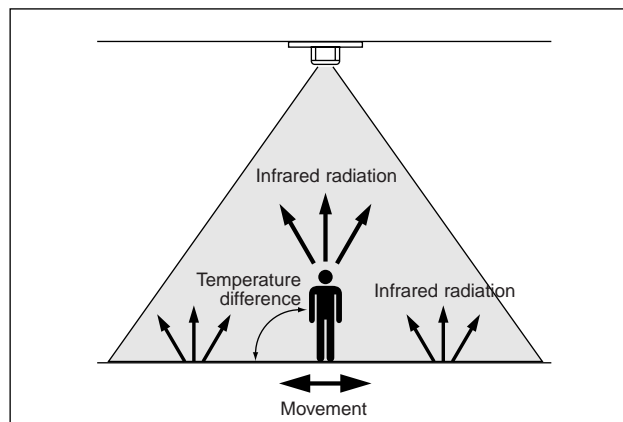

Detection area of standard type

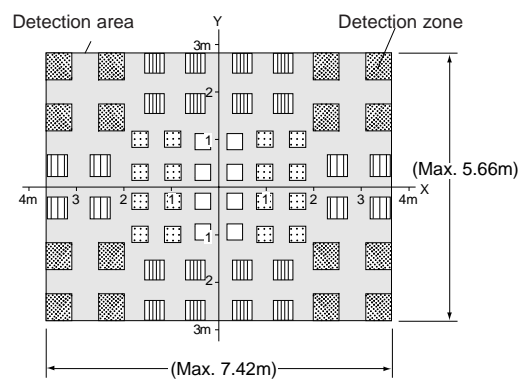
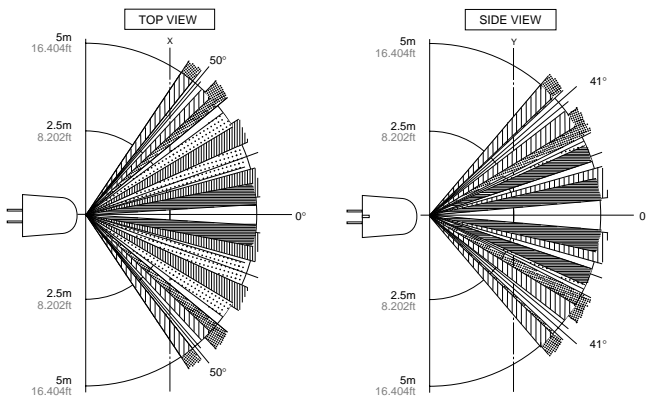

In the detection zone, above, the sensor turns on when a temperature change exceeds the regulated amount.

MA Motion Sensor

These sensors detect the human body via the area reflection system.

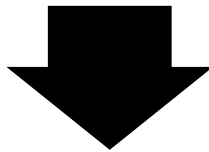
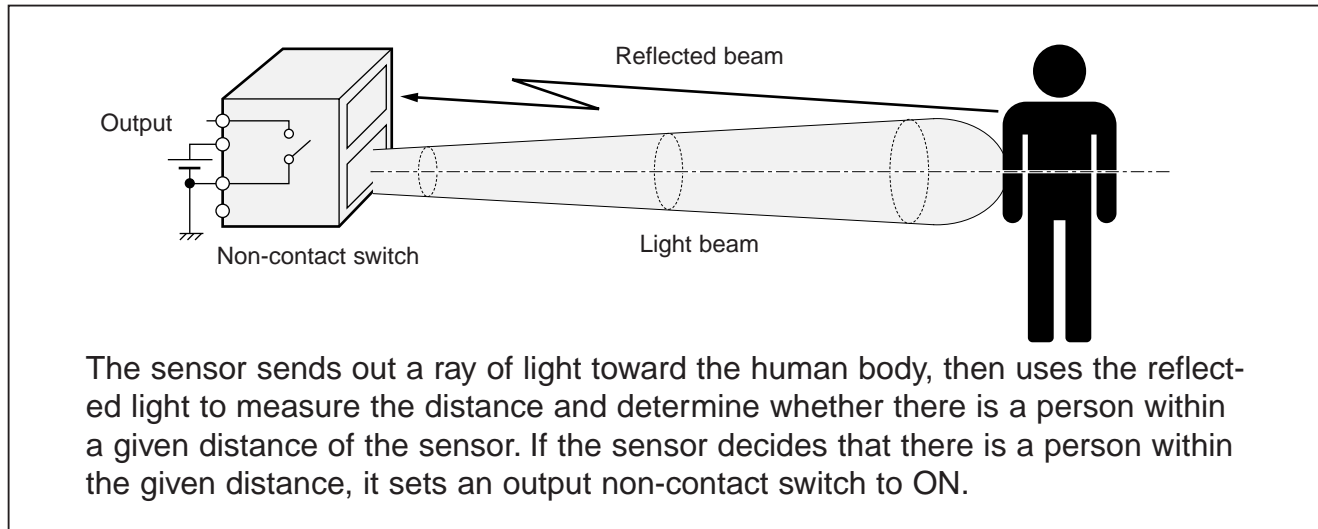

The triple-angle distance measurement configuration makes it difficult to be affected by the color (reflection ratio) of the detection object. This is the high-precision distance measurement method used in the auto-focus systems in cameras.

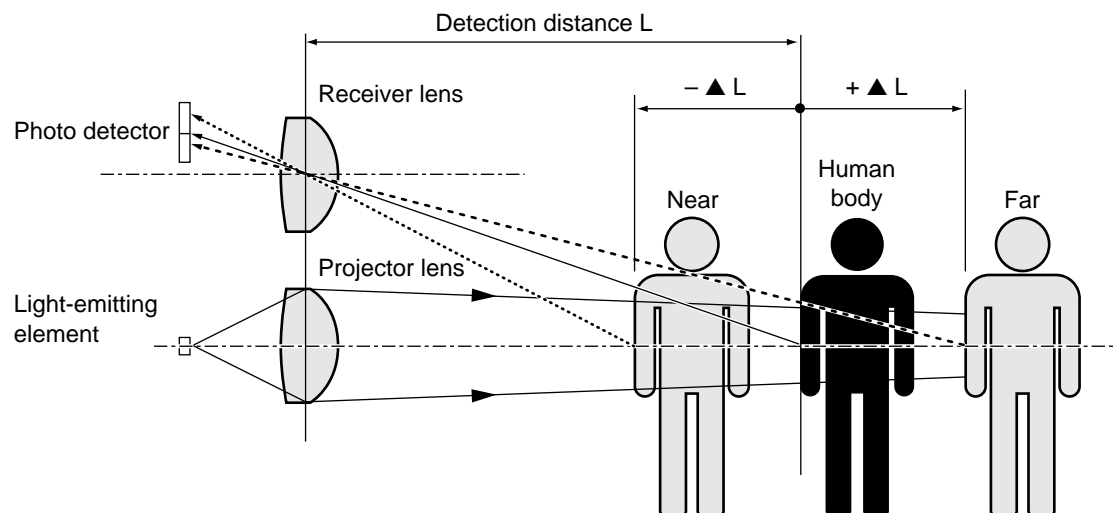

The system is configured so that the received light spot comes almost the center of the photo detectors when if a human body is located at the detection distance L . The system determines whether the body is farther ($L + \Delta L$) or closer ($L - \Delta L$) by the position of the received light spot.

3

FEATURES

Passive infrared type MP Motion Sensor 'N a P i O n'

FEATURE 1 The world's smallest with a built-in amplifier

Easy to incorporate into small devices.

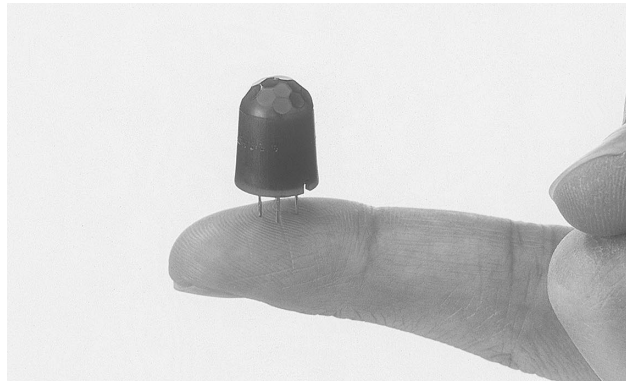
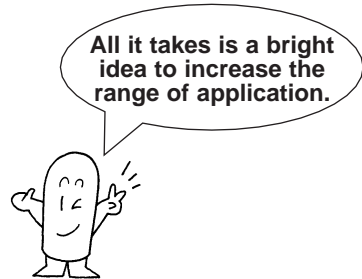

Motion detecting sensor area type

<Conventional type>

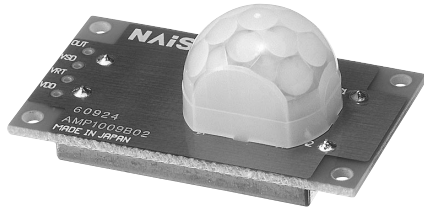

Actual size

About 1/10 the volume and 1/5 the lens surface area of conventional motion detecting sensors.

MP Motion Sensor 'N a P i O n'

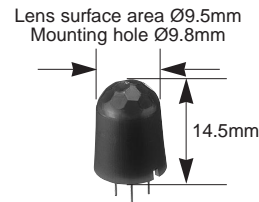

Actual size

Standard type

Here is the secret to the world's smallest sensor

Structural diagram

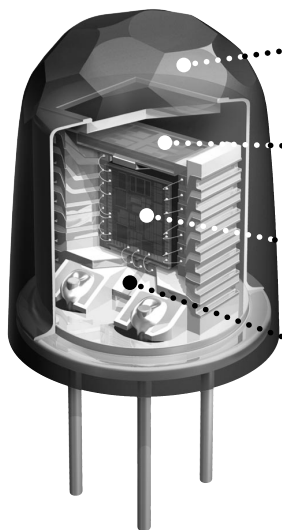

Our motion sensor is based on know-how developed over many years, including our proprietary technology for lenses, detector elements, ICs and mounting.

Small multi-lens

Proprietary high-precision molding technology is used to integrate 16 short-focal-point lenses with five different optical axes in order to reduce size.

Highly sensitive quad element

U-shaped slits are formed around the four light-receiving units to improve heat insulation, reduce element size and increase element sensitivity.

Single-chip IC with built-in amplifier and comparator

Proprietary circuit technology which is different from ordinary FET technology is used to create a single-chip IC which contains both an amplifier circuit and a comparator circuit.

MIPTEC (Microscope Integrated Processing Technology) application device

Employing MIPTEC which has our proprietary MID (Molded Interconnect Device) technology, the element, IC and chip component is mounted in a MID at high density and contained in a TO5 metal package (9.8 mm x 9 mm dia.).

3. Features of MP Motion Sensor 'NaPiOn'

FEATURE 2 Circuit design is easy because the amp and comparator are built in (except for analog output type).

The digital output enables connection directly to microcomputers.

MP motion sensor block diagram

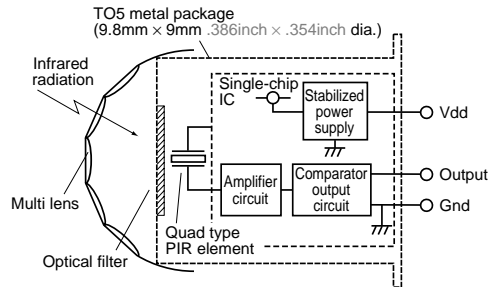

Key point

To achieve the same scheme as the 'NaPiOn' MP Motion Sensor, a sensor element, amplifier and comparator are required.

The output from the sensor element is extremely weak in the passive infrared scheme, thus the signal must be amplified and converted to an ON/OFF signal with a comparator circuit before output.

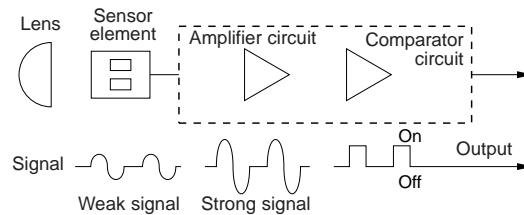

NaPiOn is not just a sensor element; it has a built in amp and comparator. Be sure to carefully check the functions, etc., when comparing with other company's products.

FEATURE 3 Noise withstanding capability

Shielding is increased because the amp circuit is built into the TO5 metal package.

Comparison table of noise withstanding capability

	Distance at which motion sensor is not affected by cellular phone noise
MP Motion Sensor	Min. 1 to 2cm .394 to .787 inch
Conventional type	Min. 1 to 2m 3.281 to 6.562ft

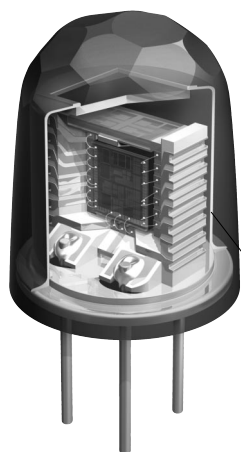

TO5 metal package

Key point

To achieve the same scheme as the NaPiOn MP Motion Sensor, a countermeasure for radiant noise in general is necessary. If noise enters the circuit between the sensor element and the amplifier, the noise will be amplified along with the weak signal, resulting in detection errors.

For this reason, shielding is necessary between the sensor element and the amplifier.

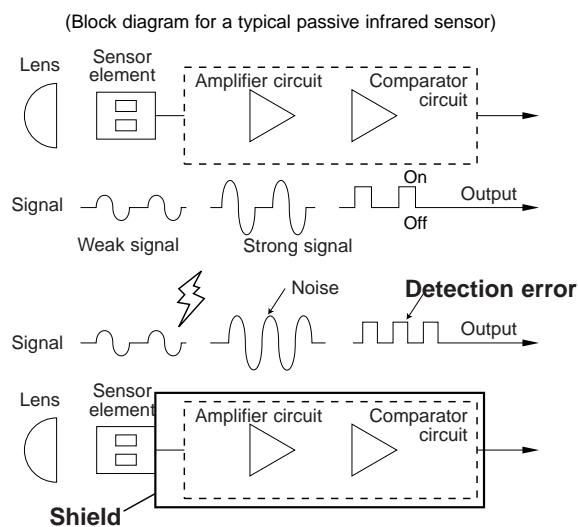

Shielding is taken care of in the 'NaPiOn' (TO5 metal package includes shielding)

Regular same-system sensors require separate noise countermeasures to be taken.

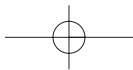

FEATURE 4 Dual lens colors (white and black) are provided

<Conventional type>

<MP Motion Sensor 'NaPiOn'>

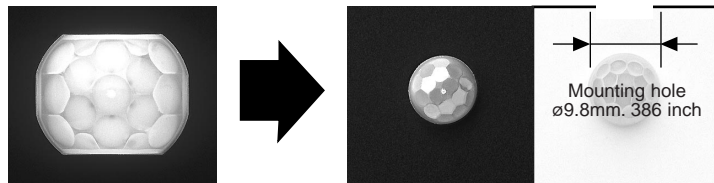

This provides greater flexibility in equipment design.

FEATURE 5 Four detection performance types are available

Detection Performance

1. Standard type

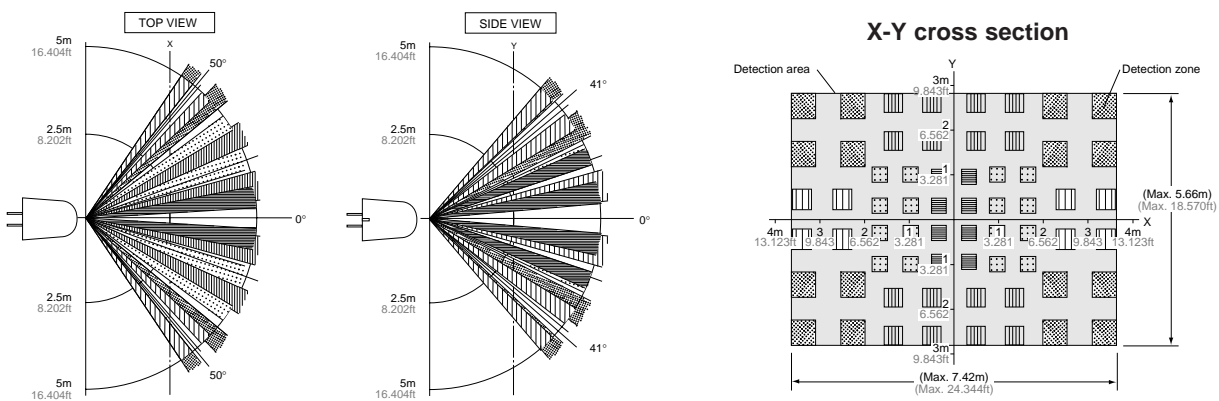

A wide horizontal detection range has been achieved for situations where the sensor will be attached to a wall and used to detect passersby.

Notes:

- 1) Detection is also possible with the sensor attached to the ceiling.
- 2) In situations where the customer wants use a sensor attached to a wall to detect slight movements, recommend the slight movement detection type.



3. Features of MP Motion Sensor 'NaPi0n'

2. Slight motion detection type

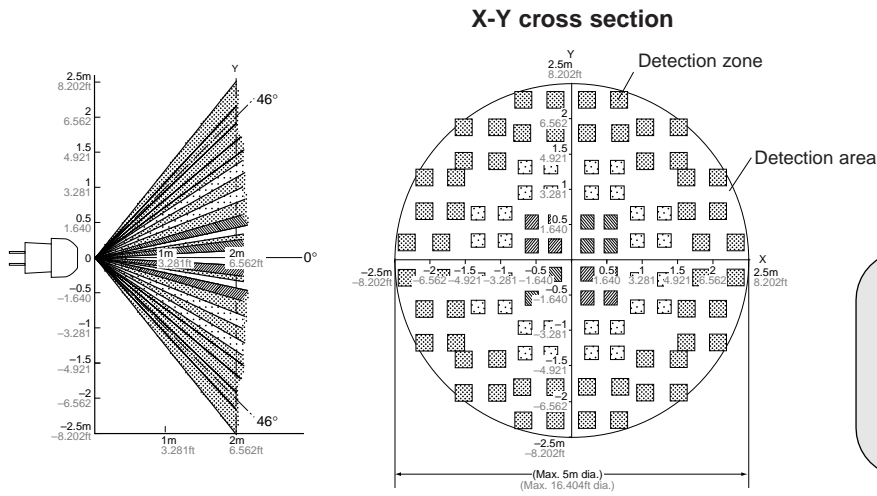

For ceiling attachment, this sensor is designed to detect slight movements in conference rooms and other rooms where people gather. Detection is also possible attached to a wall.

3. Spot type

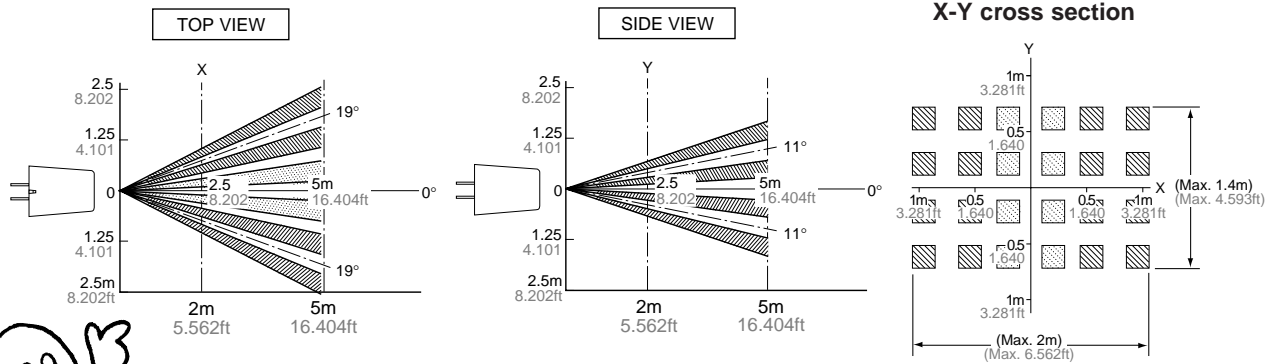

Ideal for detecting people in small areas, such as for voice guidance or entry light control.
Note: Recommended when you want to further restrict the detection range.

4. 10m detection type

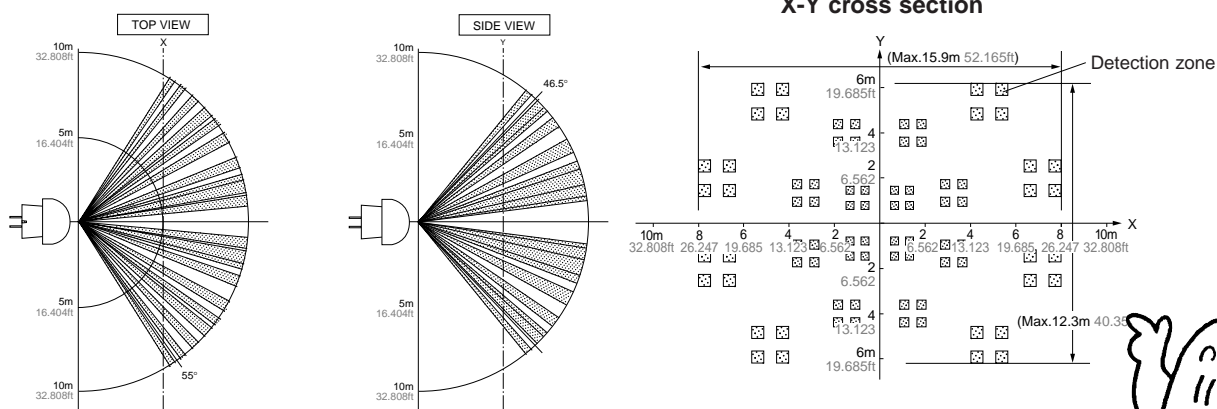

Ideal for detecting people over larger areas than the standard type.



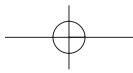

Note on the detection zone:

As indicated at right, the detection zone has polarity. If two objects enter the zone in the + and - directions at the same time, the signals from each may cancel each other and make detection impossible in the vicinity of the maximum detection distance.

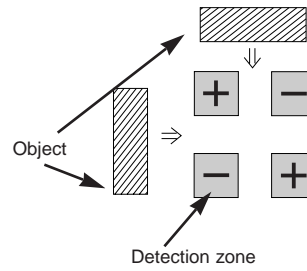

Application methods

1. Setting the sensor so it will not detect people who are far away

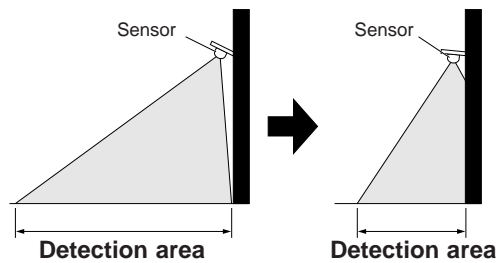

2. For detection in only a limited area

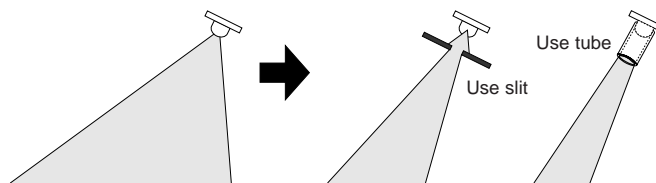

FEATURE 6 Analog output type also available that allows sensitivity adjustment

Designed for situations in which the surrounding environment has an adverse effect on performance (when you want to reduce the difference between the background temperature of summer and winter, or eliminate the effect of varying air conditioner output). Being able to check the degree of influence using an analog value, the user can set the threshold whereby such influence can be ignored.

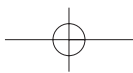

Area reflective type MA Motion Sensor

FEATURE 1 Because of the distance-measured type, accurate sensing is possible with little influence caused by reflection ratio of the detection object.

With commonly used light intensity type sensors (which detect objects by the amount of reflected light), performance is greatly affected by the reflectivity of the detected object.

However, since the MA motion sensor does not detect based on the amount of reflected rays, it features the ability not to be easily influenced by the reflection ratio because detection is based on the position of the receiving spot in the receive element.

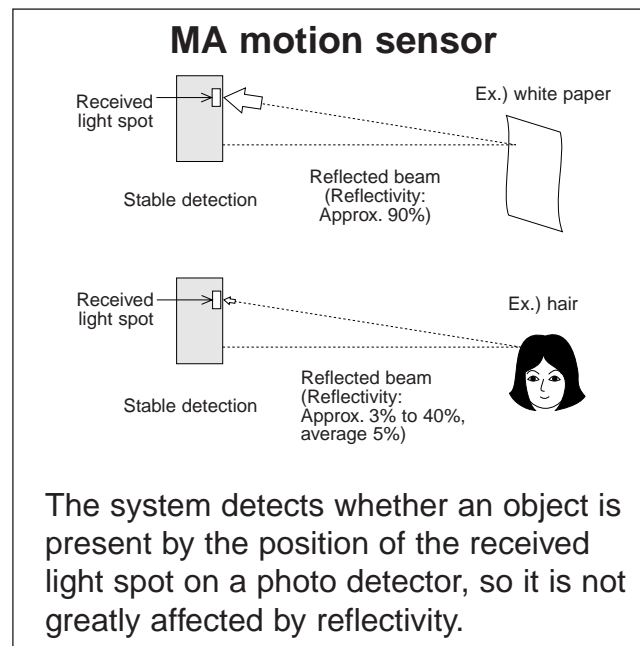
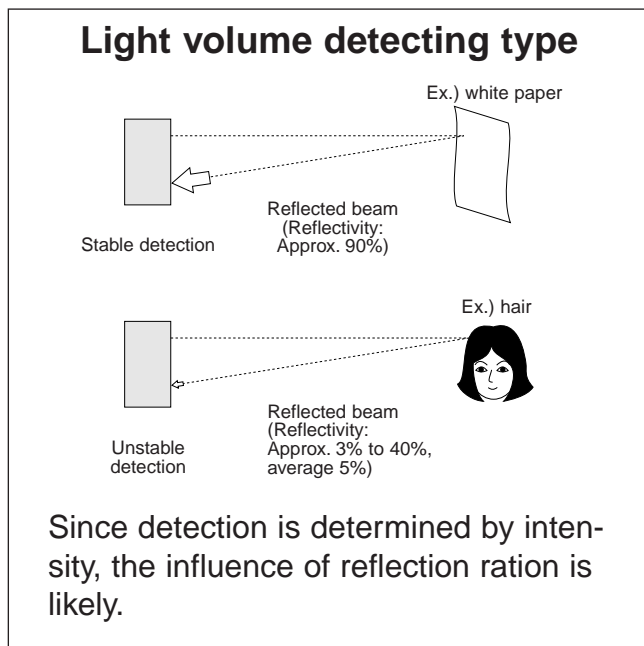

A non-spherical lens is used both for projector and receiver.

Using a non-spherical lens in this sensor, the projector lens can produce the incident light efficiently from the light-emitting element. In addition, the receiver lens can efficiently gather the entering light into the photo detector. As a result, an accurate distance measurement can be made even if the detected object has low reflectivity.

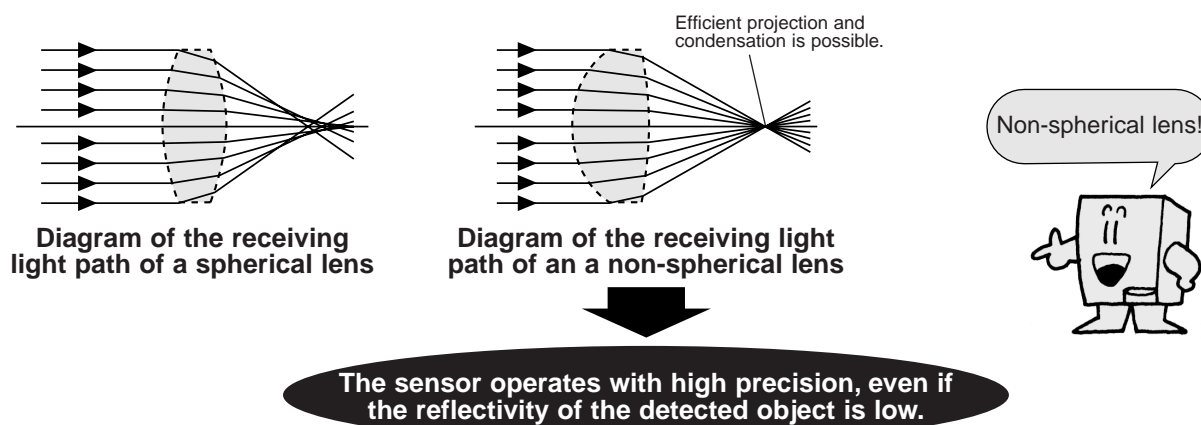

FEATURE 2 A built-in oscillation circuit type (internal trigger) and an external triggering type are available.

Built-in oscillation circuit type

Simply connect a DC power source and the sensor is ready for use.

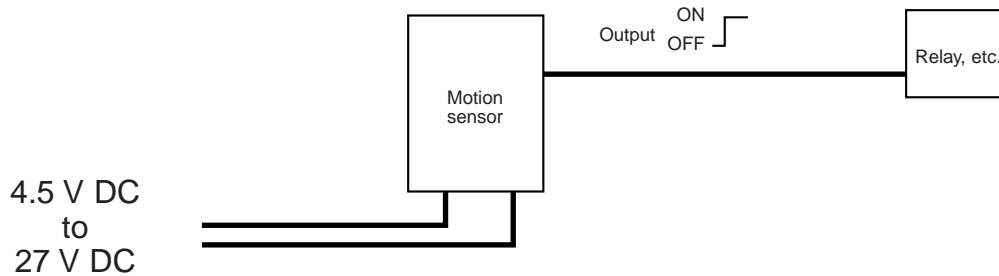

Just connect a DC power source and you're ready to go!

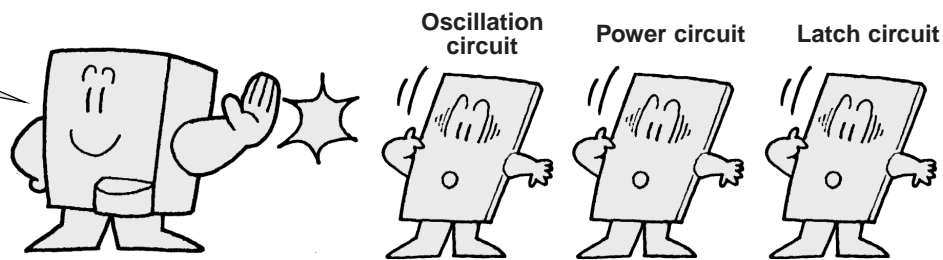

External triggering type

Sensors can be connected sequentially. Input each external trigger signal in sequence to prevent reciprocal interference.



Can be driven by a battery

Establishing an interval between external trigger signals reduces current consumption in the sensor.

Example of usage

Automatic flushing of men's urinal
 Rate of use of urinal: 30 minutes per day
 Trigger period: 2 seconds per trigger

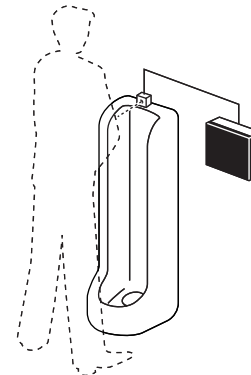

	Built-in oscillation circuit type	External trigger
Average current consumption	5480μA	160.5μA
Battery life (4 alkaline batteries)	Approx. 30 days	Approx. 1000 days (2.8 years)

FEATURE 3 Can be used with a number of different power supply voltages

- 1) The 5 V DC type (4.5 to 6.5 V DC)
- 2) The free-ranging power type (6.5 to 27 V DC)

They support the DC power supplies of electronic products and equipment in general.

FEATURE 4 Ultra-compact size, suitable for built-in applications

Motion sensors are designed to be built into equipment. We have achieved an ultra-compact size, so these sensors will not affect equipment size or interfere with design.

A series of three types to suit the detected object

Three types “Short type”, “Middle type” and “Long type” are available. Naturally, the shorter the distance, the more compact the type. Also, the rated detection distance can be changed at the factory to meet specific customer needs.

Type	Rated detection distance (Range of variation)
Short type	Change possible in 1 cm increments between a 5 cm and 10 cm range.
Middle type	Change possible in 10 cm increments between a 20 cm and 80 cm range.
Long type	Change possible in 10 cm increments between a 30 cm and 200 cm range.

Short type

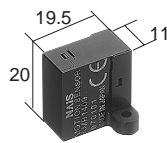

Middle type

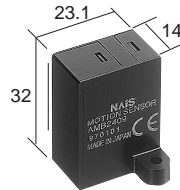

Long type

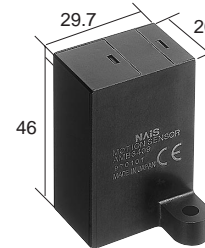

10 cm (3.937 inch)

80 cm (31.496 inch)

200 cm (78.74 inch)

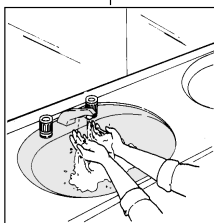

Detects hands
Intentionally uses a hand-based non-contact switch



Used as an ON/OFF switch for when a person stands in front of equipment.

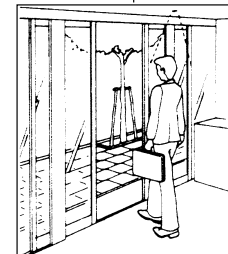

Set-up on the ceiling of a room, and used to detect whether a person is in the room or seated.

As shown below, the detection area of this sensor is the area up to the rated detection distance excluding the non-sensitive zone.

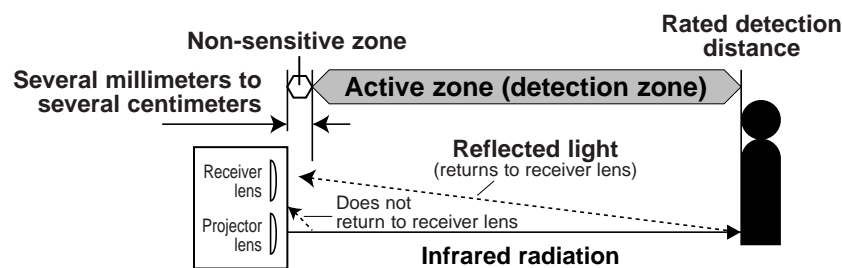

**FEATURE
5****These sensors are highly resistant to disturbing ambient light, and can be used worry-free in bright spaces**

Factory automation sensors are used under conditions which are closely controlled to suit the application. MA motion sensors, however, are built into equipment, so they may sometimes be used at locations which are exposed to sunlight (however, the direct sunlight to sensor is impossible).

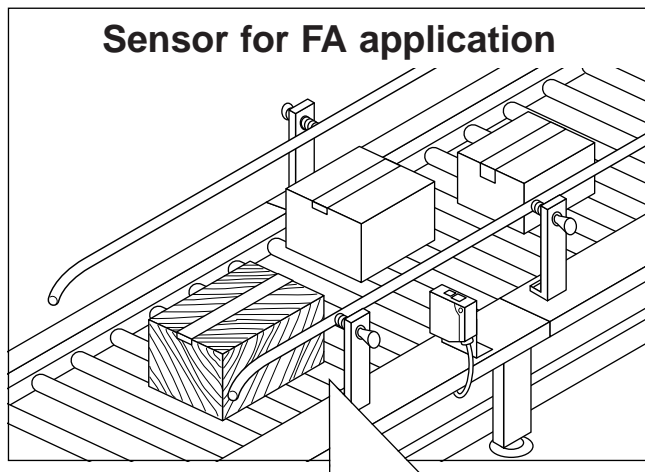
**Sensor for FA application**

Closely controlled environment

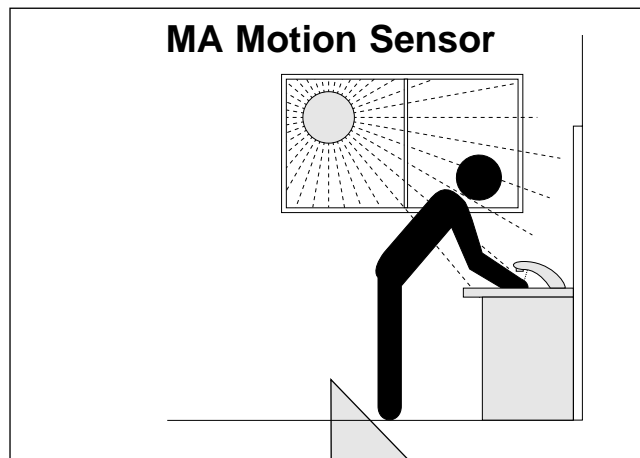
**MA Motion Sensor**

Sensor may be used at a bright location which are exposed to sunlight

Usable ambient brightness (ambient light immunity) is one of the important points to be checked when using sensors in bright locations.

Normally, for factory automation applications the usable ambient brightness is 3,000 to 10,000 lx.

MA motion sensors can operate at 30,000 lx, i.e, the brightness near a window on a summer day.

**FEATURE
6****Circuit design is easy**

The detection result takes the form of ON/OFF output (open collector transistor output), thus a reference circuit is not necessary and circuit design is easy.

**FEATURE
7****All models with built-in oscillation circuit type meet CE mark standards**

Conforms with EMC directive for CE certification vital for use in Europe.

**FEATURE
8****High speed detection is possible**

- Built-in oscillation circuit type: measuring period 8 ms/time (typical)
- External triggering type: measuring period 5 ms/time (typical)

4

How to use and cautions for use

1. How to use

MP Motion Sensor ' N a P i 0 n '

The MP Motion Sensor has three pins. Connections are as follows:

(Digital output type)

1. Wiring diagram

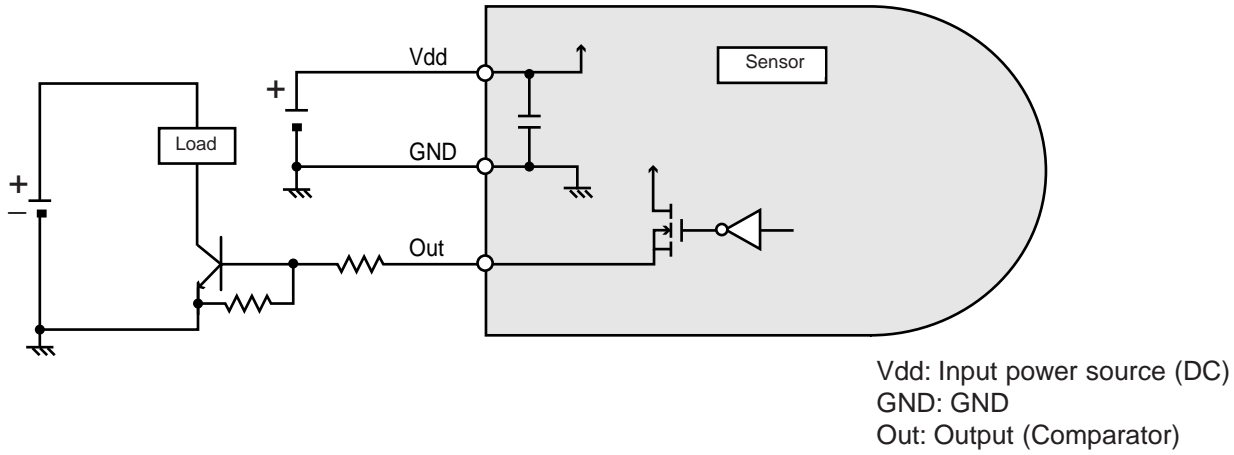

2. Timing chart

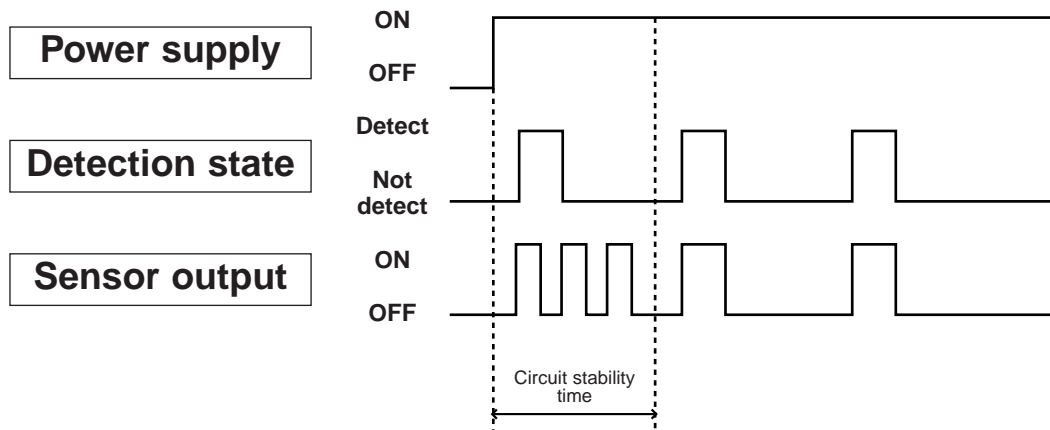

- Note: Circuit stability time: Max. 30 sec.
 While the circuitry is stabilizing after the power is turned on, the sensor output is not fixed in the "on" state or "off" state. This is true regardless of whether or not the sensor has detected anything.
 For this reason, please combine with a device that contains a function for preventing output during this time.
- Note: The spot and 10m detection types are subject to change without notice due to improvements in product performance, characteristics and dimensions. Please contact us with any inquiries you may have.

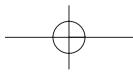

(Analog output type)

1. Wiring diagram

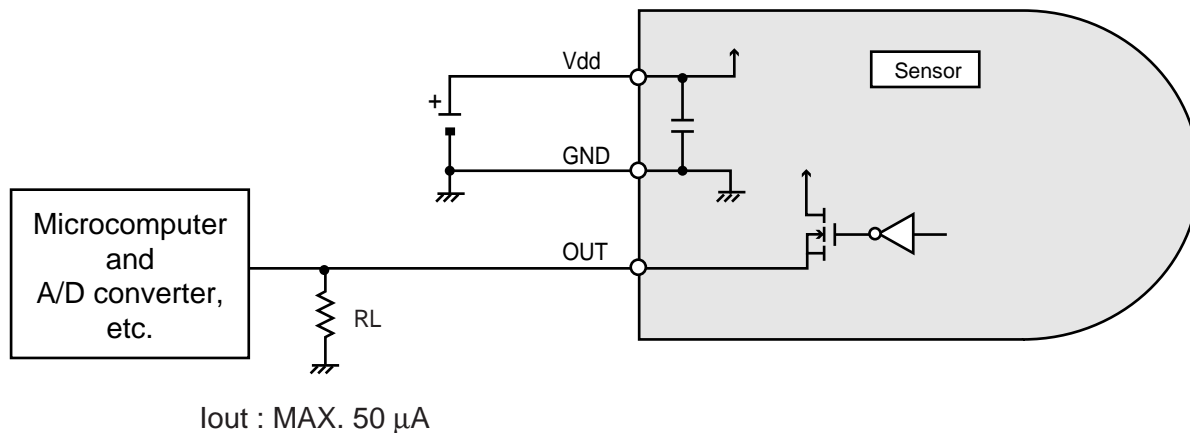

2. Timing chart (analog output type)

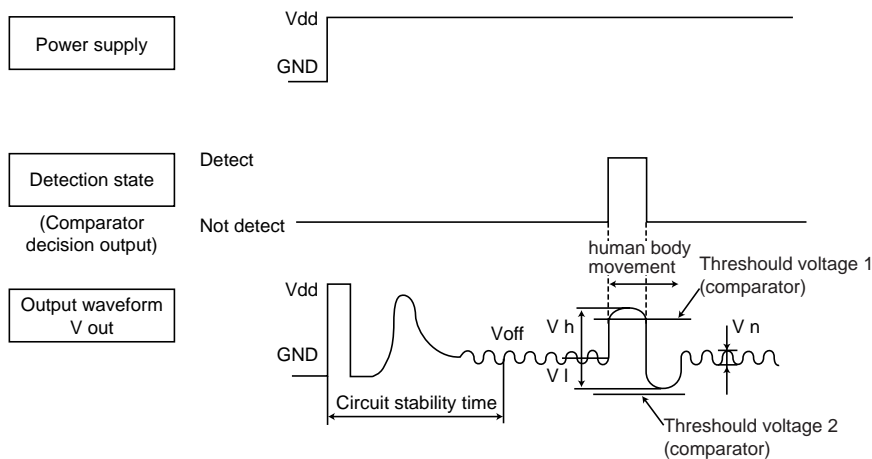

Note: Circuit stability time: Max. 45 sec.
 While the circuitry is stabilizing after the power is turned on, the sensor output is not fixed in the "on" state or "off" state. This is true regardless of whether or not the sensor has detected anything.
 For this reason, please combine with a device that contains a function for preventing output during this time.

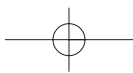

MA Motion Sensor

The MA Motion Sensor has four pins. Standard connections are as follows:

(Built-in oscillation circuit type)

1. Wiring diagram

The output is open collector transistor output.

Output voltage (Load voltage): 30 V

Output flow current (Max. output current): 100 mA

Circuit for a common source voltage for the sensor and the load

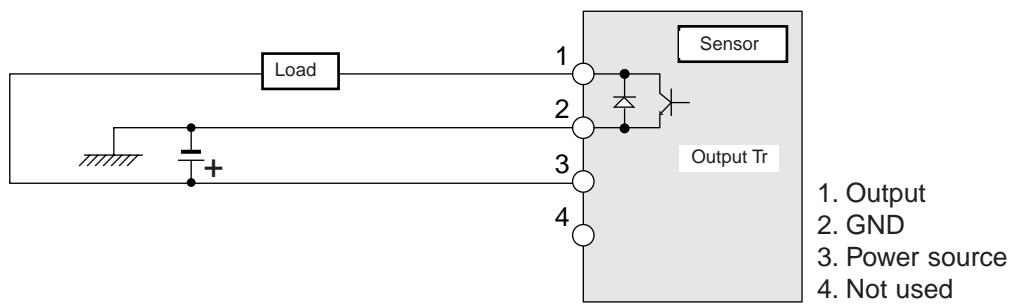

Circuit for separating the sensor source voltage and the load source voltage

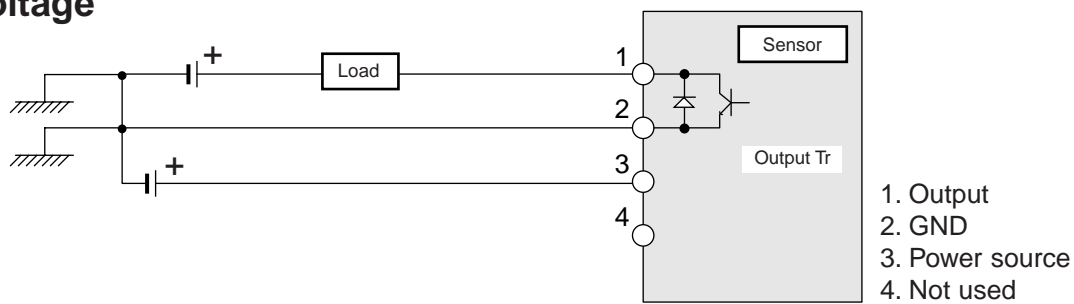

2. Timing chart

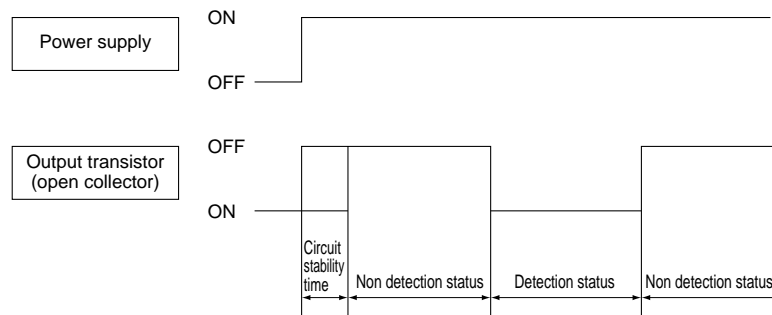

- Notes: 1. Circuit stability time : Max. 12 ms.
2. During the time taken for the circuit to stabilize after the power is turned on, the ON/OFF status of the output transistor is not determined by whether the sensor is in the detection status or non-detection status.

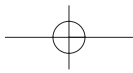

(External trigger type)

1. Wiring diagram

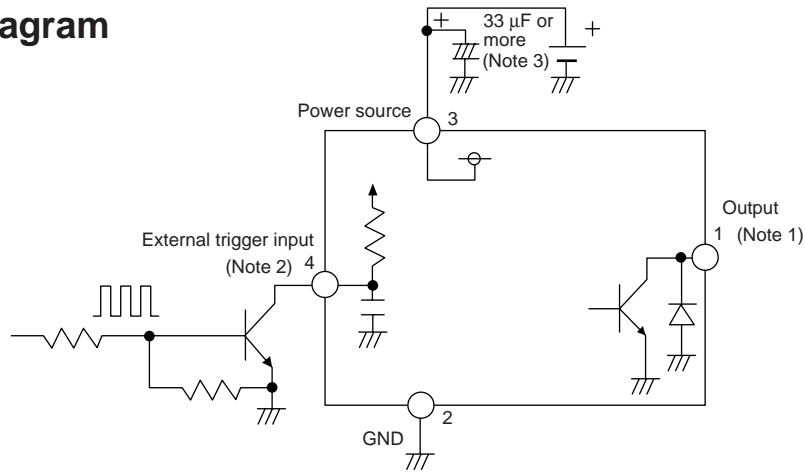

- Notes:
- Output transistor is an open collector.
 Detection status: Output transistor ON (connected to GND)
 Detection status: Output transistor OFF (open status)
 - External trigger input is as follows:
 High level: Open
 Low level: GND (Max. 0.8 V)
 Be absolutely sure not to apply high level voltage.
 - For the trigger type, in order to maintain a heavy power noise function, be sure to provide a capacitor (at least 33 µF) at the sensor power input terminal. This will stabilize the power supply voltage.

2. Timing chart

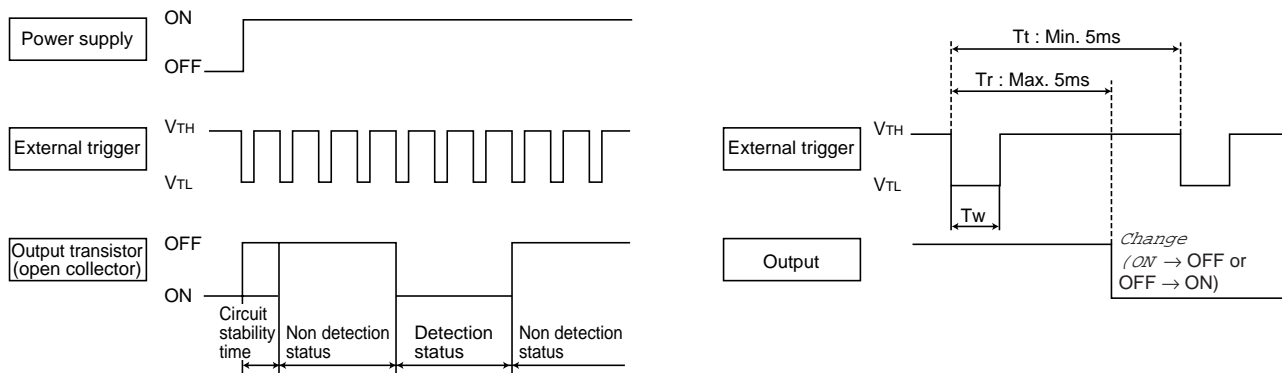

- Notes:
- Circuit stability time : Max. 12 ms.
 - During the time taken for the circuit to stabilize after the power is turned on, the ON/OFF status of the output transistor is not determined by whether the sensor is in the detection status or non-detection status.

Note: 1. The sensor recognizes that an external trigger has been input at the VTH → VTL edge of the external trigger.

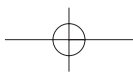

2. Cautions for use

Cautions for MP Motion Sensor 'N a P i 0 n'

1. Checkpoints relating to principle of operation

MP motion sensors are passive infrared sensors which detect changes in the infrared rays. They may fail to detect successfully if a heat source other than a human being is detected or if there are no temperature changes in or movement of a heat source. Care must generally be taken in the following cases. The performance and reliability of the sensors must be checked out under conditions of actual use.

<1> Cases where a heat source other than a human being is detected.

- 1) When a small animal enters the detection range.
- 2) When the sensor is directly exposed to sunlight, a vehicle's headlights, an incandescent light or some other source of far infrared rays.
- 3) When the temperature inside the detection range has changed suddenly due to the entry of cold or warm air from an air-conditioning or heating unit, water vapor from a humidifier, etc.

<2> Cases where it is difficult to detect the heat source

- 1) When an object made of glass, acrylic or other subject which far infrared rays have difficult passing through is located between the sensor and what is to be detected.
- 2) When the heat source inside the detection range hardly moves or when it moves at high speed; for details on the movement speed, refer to the section on the performance ratings.

2. Other handling cautions

- 1) Be careful not to allow dust or dirt to accumulate on the lens as this will adversely affect the detection sensitivity.
- 2) The lens is made of a soft material (polyethylene). Avoid applying a load or impact since this will deform or scratch the lens, making proper operation impossible and causing a deterioration in its performance.
- 3) The sensor may be damaged if it is exposed to static with a voltage exceeding $\pm 200V$. Therefore, do not touch its terminals directly, and exercise adequate care in the handling of the sensor.
- 4) When the leads are to be soldered, solder them by hand for less than 3 seconds at a temperature of less than $350^{\circ}C$ $662^{\circ}F$ at the tip of the soldering iron. Avoid using a solder bath since this will cause a deterioration in the sensor's performance.
- 5) Do not attempt to clean the sensor. Cleaning fluid may enter inside the lens area causing a deterioration in performance.
- 6) When using the sensors with cables, it is recommended that cables which are shielded and as short as possible be used in order to safeguard against the effects of noise.

Cautions for MA Motion Sensor

1. Ambient operating conditions

- 1) Avoid using the sensor in environments containing excessive amounts of steam, dust, corrosive gas, or where organic solvents are present.
- 2) When the sensor is used in noisy environments, connect a capacitor (minimum $33 \mu F$) across its power input terminals.

2. Wiring

- 1) Check all wiring before applying power. Incorrect wiring may damage the internal circuit (in particular, check that the connection to the power supply is not reversed.)
- 2) Avoid excessive removing and replacing of the connector.

3. Detector surface (Optical surface)

- 1) Keep the detector surface clean. Excessive dust or dirt on the detector surface will deteriorate the sensing performance.
- 2) Do not allow condensation or freezing to occur on the surface of the sensor. If condensation or freezing does occur at low temperatures, the sensor may not detect objects correctly.
- 3) This product is designed to detect the existence of human body. The sensor will not detect objects consisting of a low reflective material (e.g., an object coated with black rubber, etc.) or of a highly reflective material

(e.g., mirror, glass, coated paper, etc.)

- 4) The front surface of the lens and case are made of polycarbonate resin and can withstand water, alcohol, oils, salts and weak acids. Other fluids such as alkalines, aromatic hydrocarbons and halogenated hydrocarbons may melt or swell the lens and case, please do not have such fluids touch the lens and case.
- 5) To protect the inner circuit, wiring should be max. 3 m 9.843 ft..

4. Recommended installation procedure

Install the MA motion sensor so that it is orientated correctly in relation to the pass directions of the target objects as shown in the figure below.

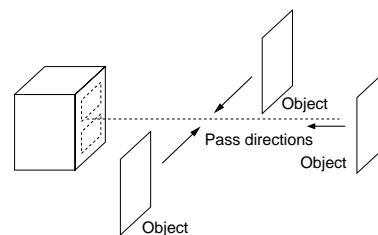

* → stands for pass direction of the target object.

Notes for Motion Sensor

1. Ambient operating conditions

- 1) Temperature: Refer to the absolute maximum ratings for the temperature of each individual sensor.
- 2) Humidity: 15% to 85% RH (No freezing nor condensation at low temperature)
- 3) Atmospheric pressure: 86 to 106 kPa
- 4) The sensors do not have a water-proof or dust-proof construction. Depending on the ambient operating conditions, some means of providing protection from water and dust and preventing the formation of ice and condensation must be provided prior to using the sensors.
- 5) Take care to avoid exposing the sensors to heat, vibration or impact since malfunctioning may result.

2. Concerning external surge voltages

Since the internal circuitry may be destroyed if an external surge voltages is supplied, provide an element which will absorb the surges. The levels of the voltage surges which the sensor can withstand is given below.

MA motion sensors: 500 V ($\pm 1.2 \times 50\mu\text{s}$ unipolar full-wave voltage)

MP motion sensors: Within the supply voltage given in the absolute maximum ratings.

3. Concerning power supply-superimposed noise

Use a regulated power supply as the power supply. Otherwise, power supply-superimposed noise may cause the sensors to malfunction. The levels of noise which the sensor can withstand is given below.

MA motion sensors: ± 200 V (50ms, $1\mu\text{s}$ wide square waves)

MP motion sensors: ± 20 V (50ms, $1\mu\text{s}$ wide square waves)

4. Drop damage

If the sensor is dropped, damage can occur resulting in incorrect operation. If dropped, be sure to do a visual check of the exterior for noticeable damage and check the operation characteristics for faulty operation.

5. Concerning the circuit sides

Since the circuit sides given in this catalog are not protected in terms of circuit design, check out the performance and reliability of the circuits prior to using the sensors.

6. The technical information contained in this catalog is used to explain general operation and use of the products. By this usage, neither our company nor any third party grants the right to use intellectual property copyrights or any other copyrights.



SAFETY PRECAUTIONS

Head the following precautions to prevent injury or accidents.

- Do not use these sensors under any circumstances in which the range of their ratings, environment conditions or other specifications are exceeded. Using the sensors in any way which causes their specifications to be exceeded may generate abnormally high levels of heat, emit smoke, etc., resulting in damage to the circuitry and possibly causing an accident.
- Before connecting a connector, check the pin layout by referring to the connector wiring diagram, specifications diagram, etc., and make sure that the connector is connected properly. Take note that mistakes made in connection may cause unforeseen problems in operation, generate abnormally high levels of heat, emit smoke, etc., resulting in damage to the circuitry.
- Do not use any motion sensor which has been disassembled or remodeled.
- The sensor has two malfunction modes: short circuit and open.
 - The short circuit mode may be triggered by an increase in temperature. In order to ensure safety, especially in important applications, please consider suitable safety measures such as a protective circuit or protection device.
 - Various safety machines and devices
 - Traffic signal lights
 - Crime and disaster prevention devices
 - Control devices and other devices that concern the safety of trains and vehicles.
 - Other important devices

Passive infrared type MP Motion Sensor 'N a P i 0 n'

Circuitry

**Q
1**

How should the sensor be wired?

See here as well!

Q3 Q7
Q5
Q6

A

1. Pin functions are as follows:

- Vdd Power source (+)
- GND Power source (-)
- Out Output terminal

2. Connect the pins as follows:

Connect the (+) terminal of the power source to Vdd.
Connect the (-) terminal of the power source to GND.

1) Digital output type

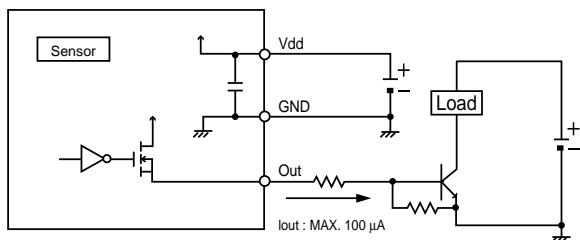

2) Analog output type

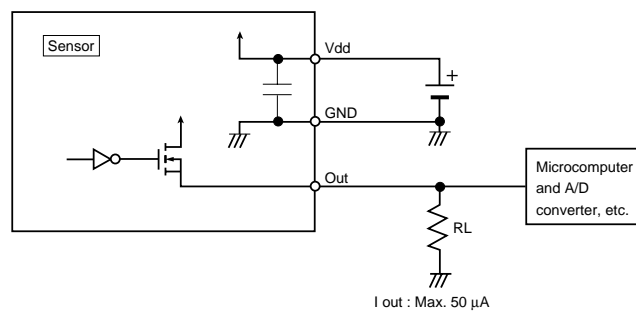

**Q
2**

Can the circuit stabilization time (wait time) be shortened?

See here as well!

A

No.

The circuit stabilization time is the time required for the internal circuit to stabilize after the power is turned on. During this time correct detection cannot take place and the output is unstable.

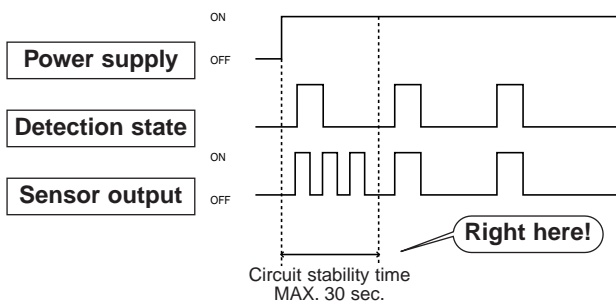

**Q
3**

See here as well!

Can the AC load be turned on and off directly?

A

This is not possible with our standard product.

Use a relay or SSR at the output of the MA Motion Sensor to turn the AC load on or off.

Please refer to the following circuits when a timer is required in your design.

Circuit example

Refer to the following circuits.

1. For mechanical relay drive

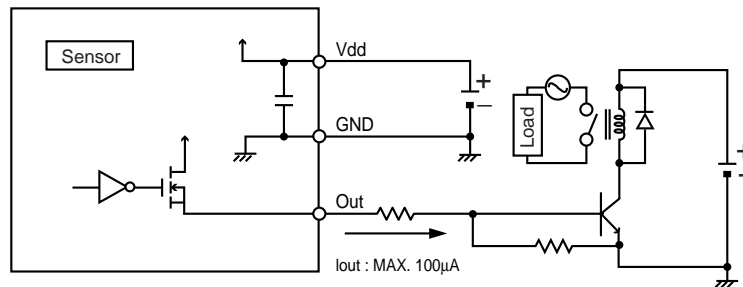

2. For SSR drive

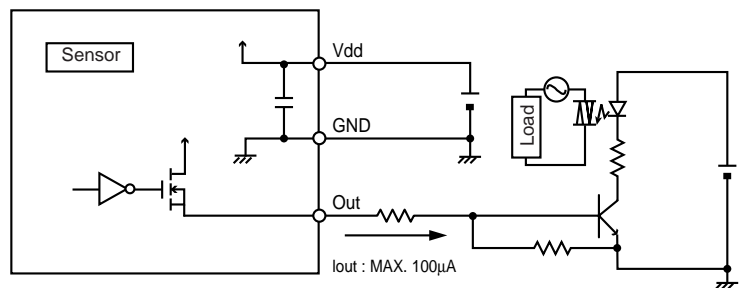

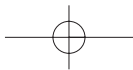

**Q
4**

I would like to use an AC power source for the input power supply.

See here as well!

A

This is not possible with our standard product.

If an AC power source is necessary, please consult us.

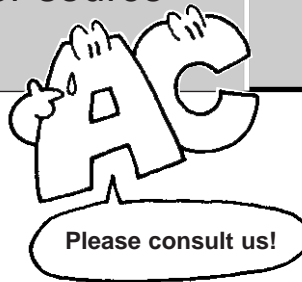

**Q
5**

Are there any products with an operating voltage of 24 V DC or 12 V DC?

See here as well!

Q1

A

We do not have any standard products with these operating voltages.

Use a regulator or other circuit to transform the voltage to 5 V DC.

Circuit example

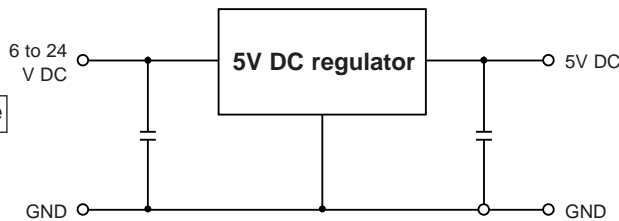

**Q
6**

I would like to use multiple sensors. Is it possible to design a common circuit for the sensors?

See here as well!

Q1

A

Yes. Be sure to connect the sensors in parallel.

Refer to the circuit at right.

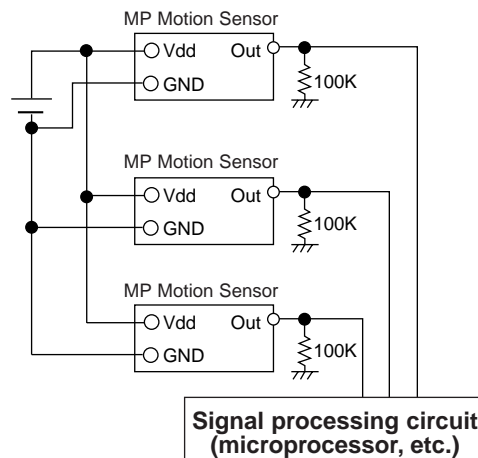
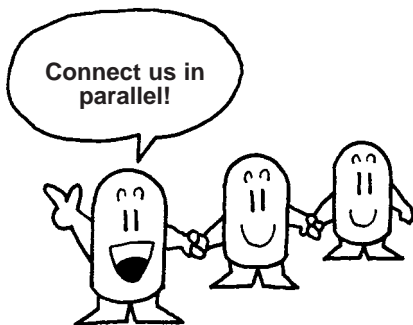

Signal processing circuit (microprocessor, etc.)



**Q
7**

How do I set the output time (timer)?

See here as well!

A

Recent devices come with built-in microprocessors. Use the microprocessor's timer function to set the output time.

If the device doesn't have a built-in microprocessor, refer to the following timer circuit.

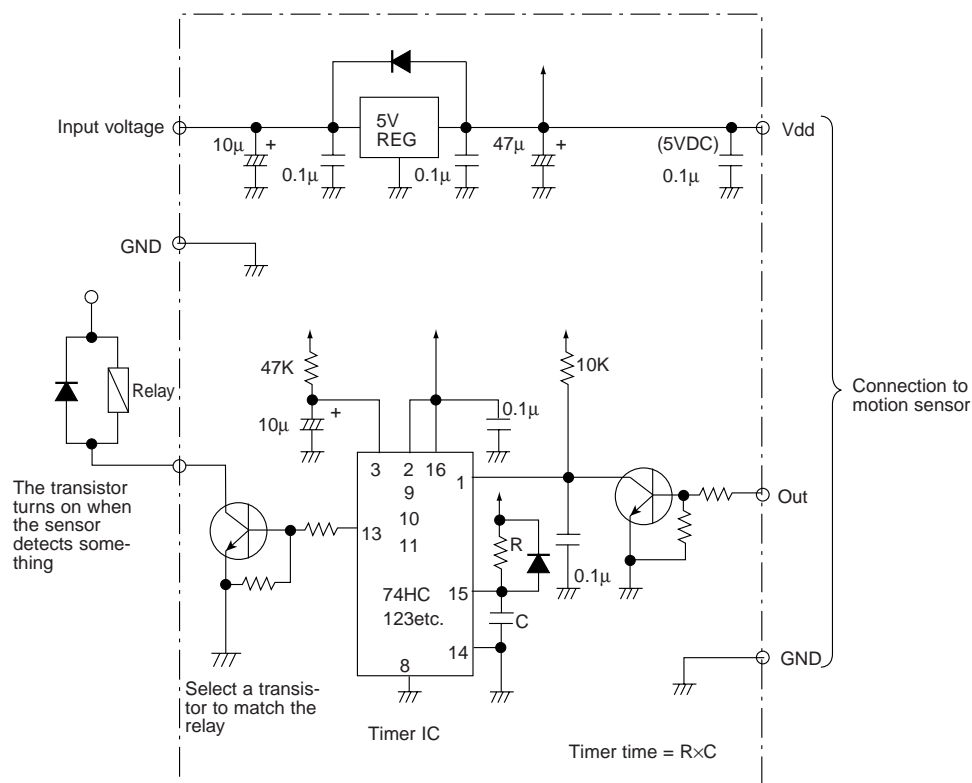

Note 1) Each timer IC manufacturer requires different values for the resistance (R) and capacitance (C) used for the time setting. Check with the manufacturer for these values before designing the circuit.

Note 2) This is the reference circuit which drives the MP motion sensor. Please note that we bear no responsibility for any damages or loss arising from the use of this circuit. Install a noise filter for applications requiring enhanced detection reliability and noise withstanding capability.

Differences in the specifications of electronic components to which the units are connected sometimes affect their correct operation; please check the units' performance and reliability for each application.

Performance

Q8

Is light for motion detection constantly emitted from the lens?

See here as well!

A

No.

The 'N a P i O n' MP Motion Sensor is a passive infrared sensor, which means that it does not emit infrared radiation to detect motion. Instead, the sensor operates by receiving infrared radiation emitted from the moving body. This is why it is called a "passive type" sensor.

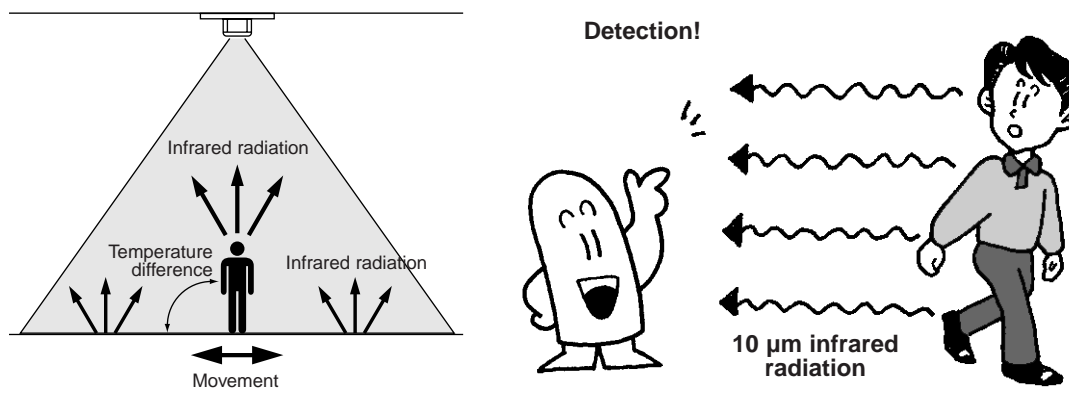

Q9

The detection distance in the catalogue is given as a "maximum". Will the sensor detect anything beyond this distance?

See here as well!

Q10	Q36
Q11	Q42

A

It may.

The sensor is rated for "detection or no detection" based on specific input conditions. The meaning of "Standard type, maximum 5 m" and "Slight motion type, maximum 2 m" in the catalogue is "the maximum distance at which detection is guaranteed".

The sensor detects motion based on the difference between the ambient temperature and the surface temperature of the person that entered the detection area, and the conditions of each will give rise to small variations in detection performance.

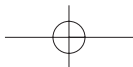

MP Motion Sensor 'N a P i O n' Questions and Answers Performance

**Q
10**

The detection of the standard type is 5 m. Can the detection distance be shortened?

See here as well!

Q9 Q39
Q11 Q42
Q36

A

No.

The best way to limit the detection distance is to change the angle of attachment of the sensor so that it points toward an obstacle such as the ground, a wall, or the ceiling.

Setting the sensor so it will not detect people who are far away

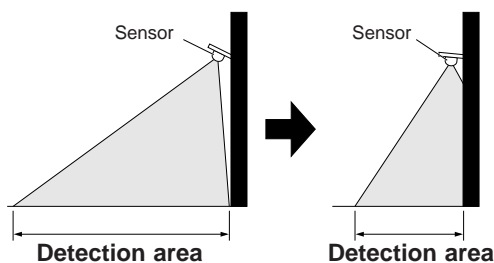

For detection in only a limited area

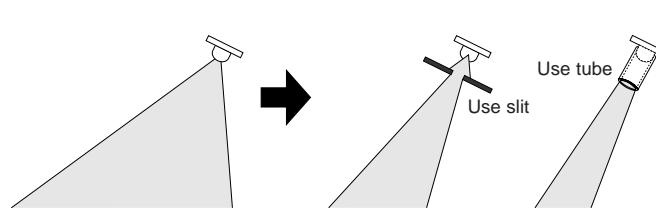

**Q
11**

Can the sensitivity be adjusted?

See here as well!

Q9 Q36
Q10 Q42

A

The sensor does not include a sensitivity adjustment function.

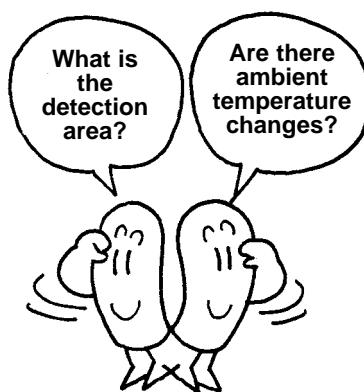

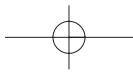

Q
12

Is performance affected by differences in operating voltage?

See here as well!

A

Detection performance is not affected, but the output voltage will change.

Q
13

How long is the interval (response time) between a person moving and detection of the movement?

See here as well!

A

Approximately 0.5 seconds.



<Timing chart>
Standard type

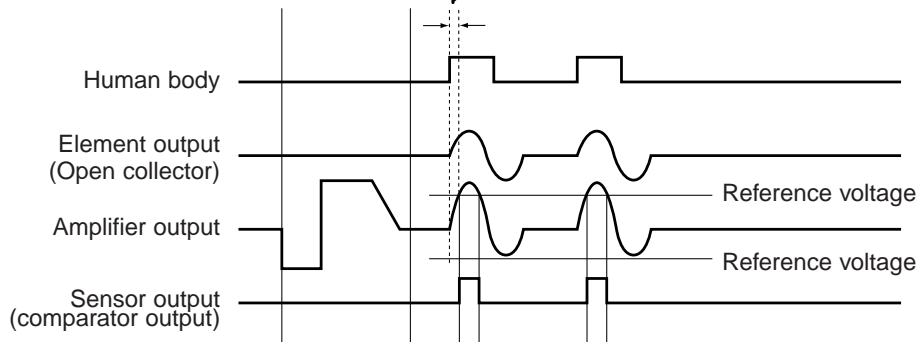

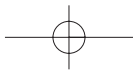

Q
14

See here as well!

What is the difference between the detection area and the detection zone?

A

●Detection zone

The zone that people are detected in. In the sensor area there are four infrared elements.

A lens of one of these elements projects and this creates four detection zones.

●Detection area

The detection area treats the four detection zones as a group and is the number of lenses of the projected detection zones collection.

●For standard type sensor

Detection area diagram for standard-type sensor

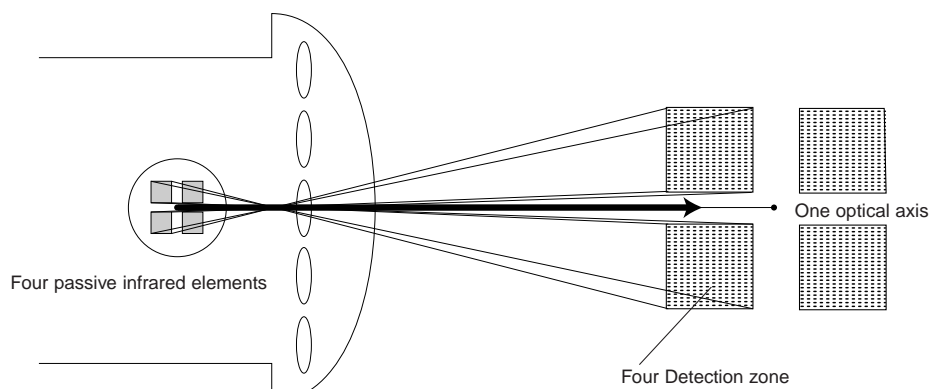





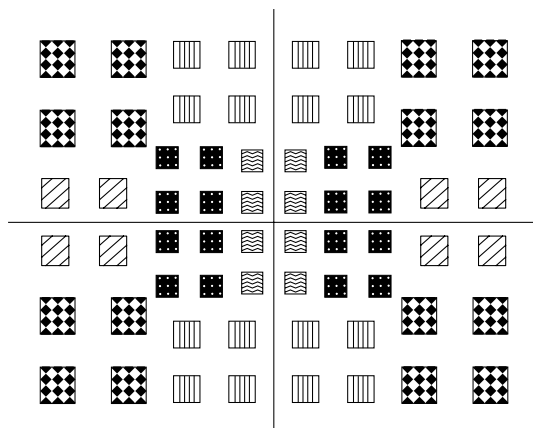

4 X Number of lenses

→ Number of detection zones

X-Y cross-section of standard type

The detection area projected onto a flat surface 2.5 m from the sensor.



The number of pattern types (    ) of detection zones is also the number of lens shape types.

The standard type has a detection area consisting of 4 detection zones X 16 single focusing lenses = 64 detection zones, with five types of detection zone patterns.

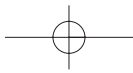

**Q
15**

For digital output type, if a person keeps moving in the detection area and the detection state persists, what kind of output appears?

See here as well!

Q16

A

ON/OFF is repeatedly output.

When the detection state persists, the characteristics of the passive infrared element cause it to repeatedly output an analog waveform as shown in the time chart below. The output is amplified by the amplifier circuit, and when it exceeds a certain reference level (reference voltage), detection results and ON is output. When the reference level is not exceeded, OFF is output.

Timing chart

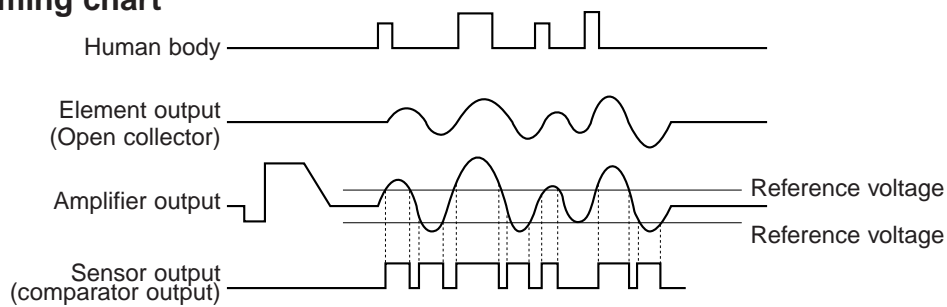

**Q
16**

What is the duration of output from the sensor after one detection?

See here as well!

Q15

A

At least 10 ms.

The output from the passive infrared element will vary depending on the speed of the detected object and the difference between the temperature of the object and the ambient temperature.

The output from the passive infrared element is amplified by the amplifier. If the amplified output exceeds the reference voltage, a person is regarded as being detected and ON is output. For this reason the duration of one output is not fixed; however, it lasts at least 10 ms due to circuit characteristics.

Timing chart

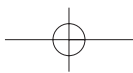
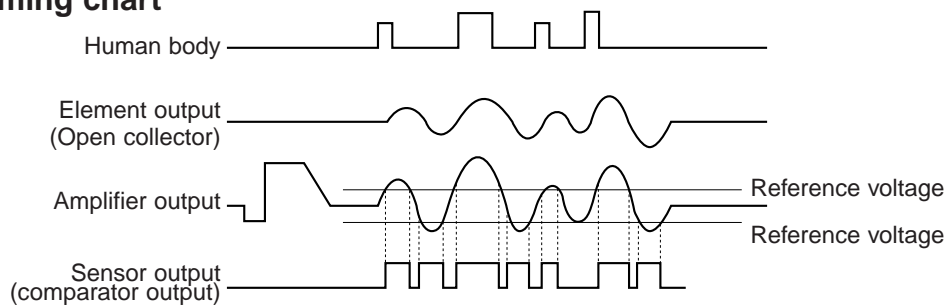

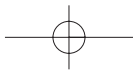

MP Motion Sensor 'N a P i O n' Questions and Answers Performance

Q
17

How much time elapses before OFF is output when the person stops moving or leaves the detection area?

See here as well!

Q15
Q16

A

From 10 ms to several seconds.

Q
18

Why doesn't the sensor have a timer circuit for setting the output time (timer time)?

See here as well!

Q7

A

Recently almost all devices have a built-in microprocessor, and we decided that the timer circuit included in previous sensors (area type Furumai sensor) is not necessary because the microprocessor's timer function can be used.
If you need a timer circuit, refer to Q7.

Q
19

What infrared wavelengths can be detected?

See here as well!

A

As indicated below, the sensor uses a filter that transmits 5µm or longer wavelengths. Therefore, long wavelengths equal to **or greater than 5µm** can be detected.

Wavelength characteristics

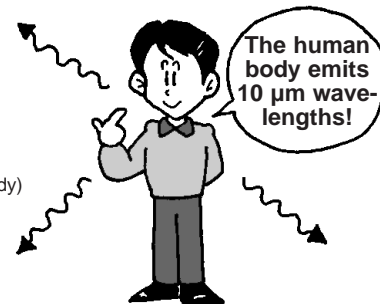
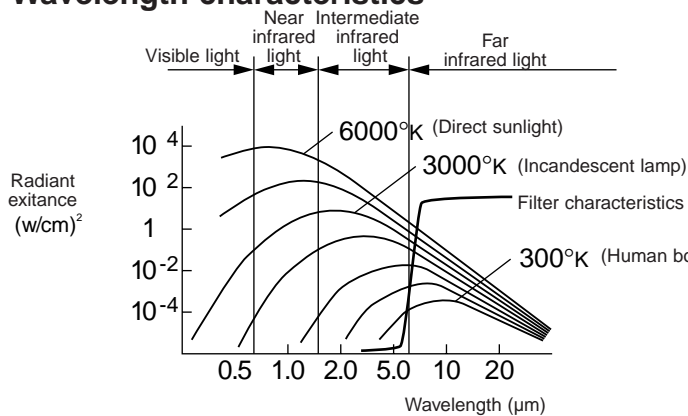

**Q
20**

When you say "a temperature difference between the object and the background of 4°C or higher", what does "background" mean?

See here as well!

- Q21 Q44
- Q37 Q45
- Q43

A

The background is the temperature of the environment surrounding (but not including) the object to be detected, such as the ground, walls, and ceiling. When a person enters the sensor's detection area, the quantity of infrared radiation incident on the sensor changes by an amount equivalent to the temperature difference between the person and the background. The MP motion sensor 'NaPiOn' detects a person by detecting this change in incident infrared radiation. In other words, the sensor operates in response to the difference in temperature between the human body, a source of heat, and the background such as the floor and walls.

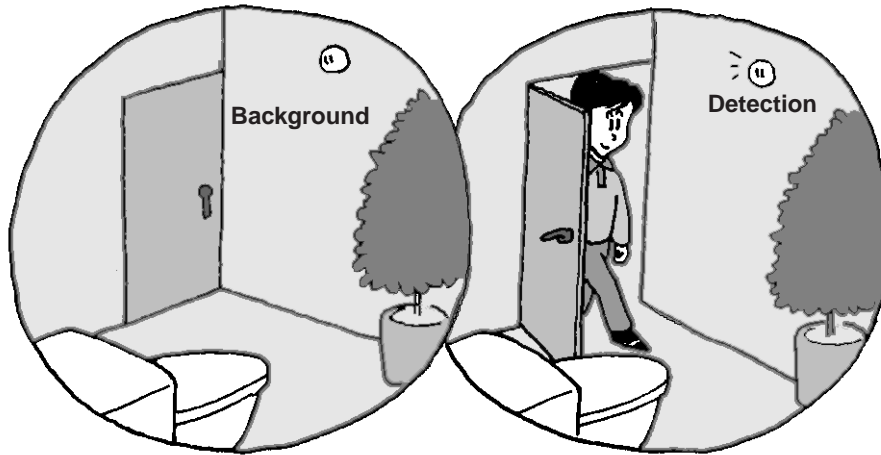

Reference date Wearing long-sleeve work clothes

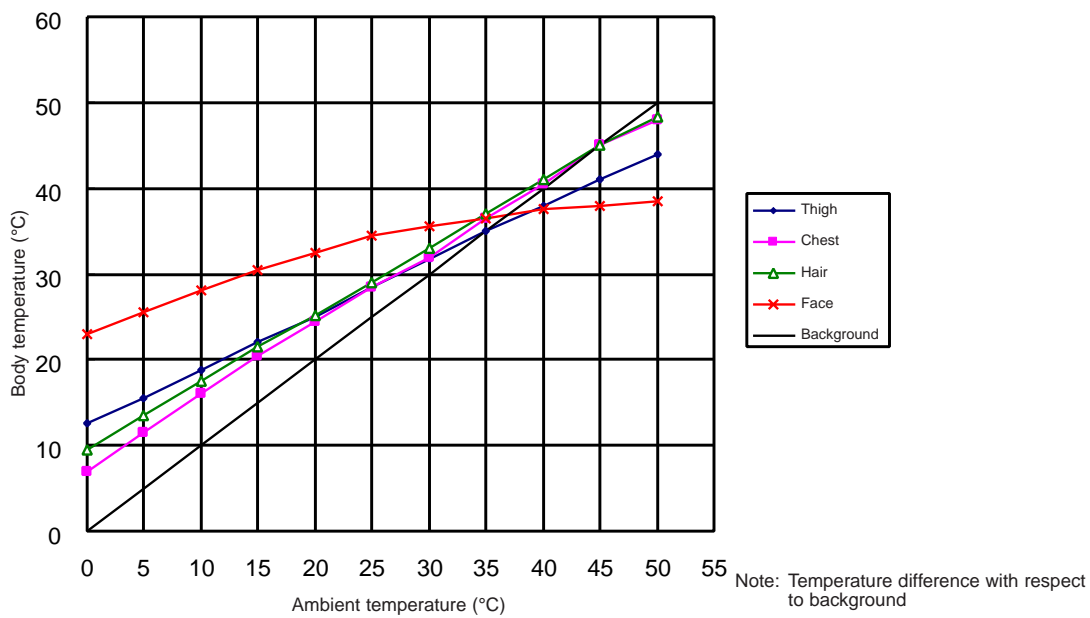

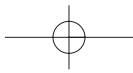

MP Motion Sensor 'N a P i O n' Questions and Answers Performance

Q
21

Does the sensor respond only to people?

See here as well!

Q20	Q44
Q24	Q45
Q43	Q46

A

No.

The sensor may also react to changes in air current caused by animals, sudden temperature changes, heaters, and air conditioners, etc. For more details, refer to the cautions in the catalogue.

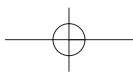
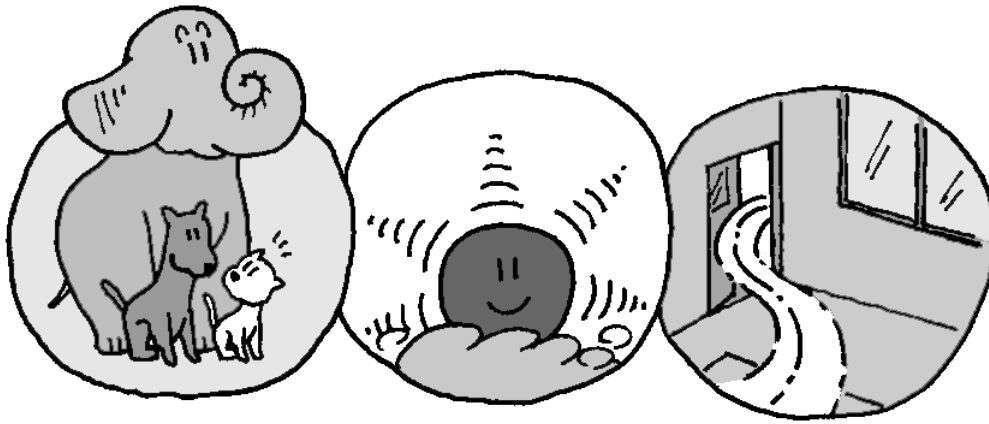

MA Motion Sensor Questions and Answers Using Sensors

Q
30

Should I assume that detection is not possible in direct light?

See here as well!

Q20

A

The maximum ambient operating illumination of the sensor is 30,000 Lx. Even in bright sunlight, and even if light shines directly on the sensor or on the object of detection, the sensor will operate correctly as long as the illumination does not exceed 30,000 Lx.

However, if an inverter light is directly within the detection area of the sensor (plus or minus several degrees), the sensor will not operate correctly. This is because the sensor cannot distinguish between light emitted from the sensor and light from the inverter light.

The sensor will operate correctly in the direction of the sun as long as its optical axis does not point directly toward the sun. The field of detection of the sensor is plus or minus several degrees, so there will be no problem if the sensor's optical axis is shifted 15° away from the sun.

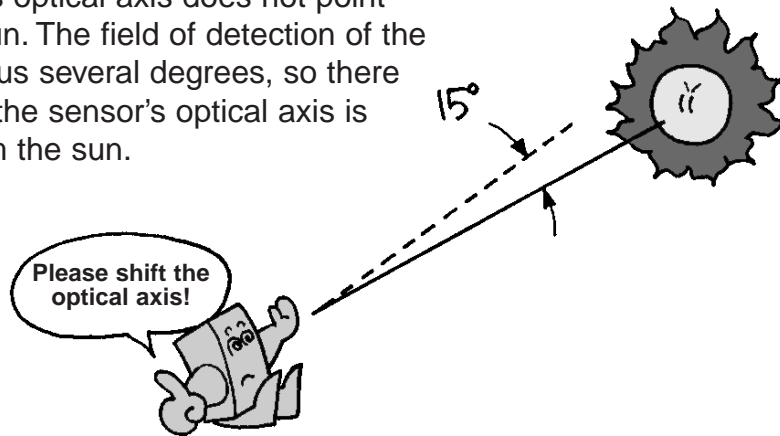

Q
31

Is there an easy way to verify sensor operation?

See here as well!

Q21

A

Connect the sensor as shown at right to have an LED illuminate when the sensor detects a person or object.

* Use a resistor value appropriate for the current that is to flow through the LED.

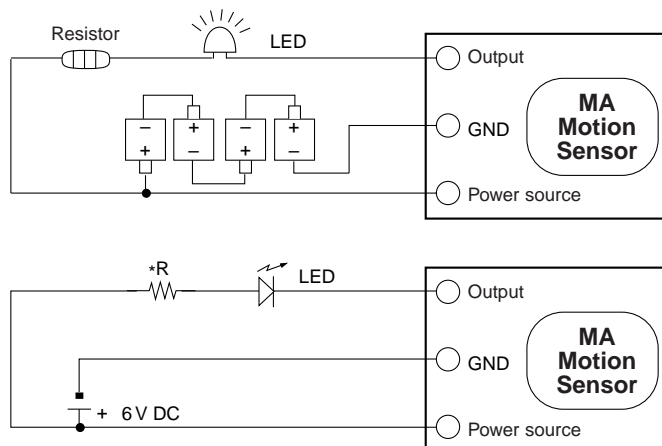

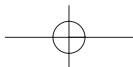

**Q
28**

Can the sensor be used if the front is half covered?

See here as well!

Q9
Q27

A

The area reflective type MA Motion Sensor is a distance measurement type sensor and thus it tends not to be affected by the intensity of light reflected from the detected object. For this reason, the sensor can detect if its front face is half covered; however, performance is noticeable impaired.

Before using the sensor, verify detection performance using the object you wish to detect.

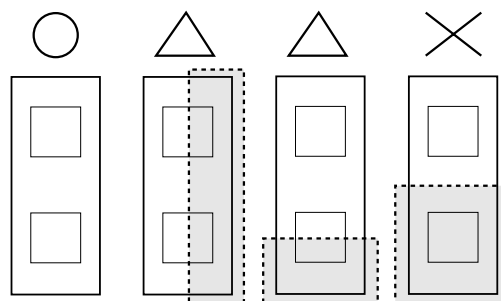

**Q
29**

Is it okay to wipe the sensor with ethanol?

See here as well!

A

Yes.

The front face of the lenses and the case are made of polycarbonate. In general, this material is resistant to water, alcohol, oil, salt, and weak acids.
 Alcohol: methanol, ethanol, etc.
 Oils and fats: turbine oil, grease, etc.

Do not use the following chemicals:

Gasoline, thinner, ammonia, caustic soda, toluene

**Q
27**

What points are important when installing a cover (filter) on the front of the sensor?

See here as well!

Q9
Q23
Q28

A

Required cover (front filter) specifications

Use a cover that transmits infrared light (wavelength: 900 nm).

Material: Acrylic, glass, or similar material

Surface condition: To prevent light dispersion, the surface roughness should be 1µm R-Max (ground glass is not acceptable)

Color: As long as the material optically transmits infrared light (wavelength: 900 nm), any visible color is acceptable. (You must be able to see through the plate.)

Thickness: Use a plate with a maximum thickness of 2 mm. (If the cover is too thick, dirt on the cover may accidentally trigger detection.)

How to install the cover

Install the cover so that it is parallel to the front face of the sensor.

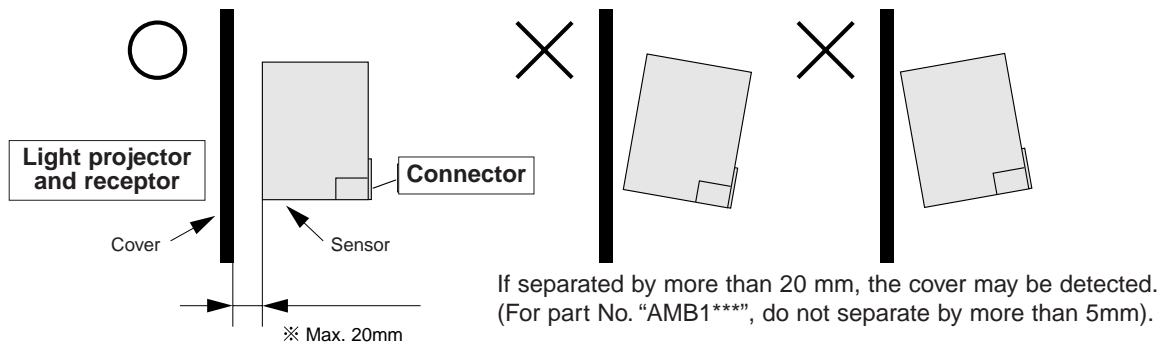

Covers of non-uniform thickness

As shown below, the detection distance can be lengthened by placing a cover or filter of non-uniform thickness in front of the sensor to produce a prism effect.

<Example>

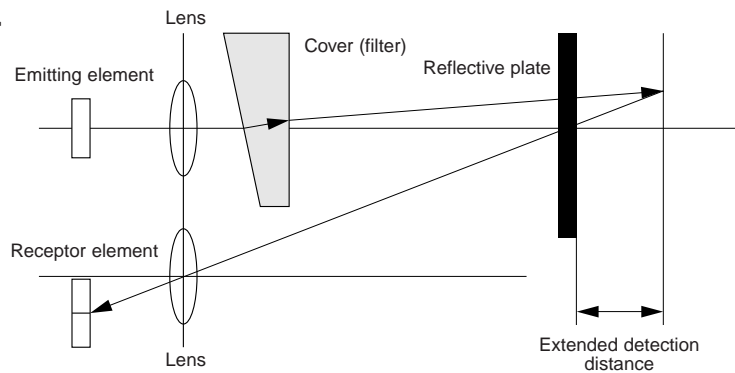

Q
26

What points are important when installing the motion sensor?

See here as well!

Q5
Q8

A

The MA Motion Sensor is designed primarily for indoor use.

The number of detection times and the presence of an object

Noise from external sources and other factors can cause the unexpected output of a detection signal. For applications requiring greater detection reliability, we recommend that you design the circuit so that the device activates only after several detection signals are output, not just one.

How to install the sensor

<Recommended installation direction>

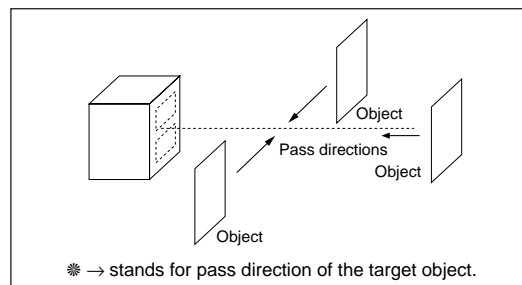

Install the sensor so that it points in the direction shown at left with respect to the direction of entry of the object.

<Recommended installation height>

The infrared beam emitted from the sensor spreads over a certain angle with respect to the front of the sensor. If you install the sensor so that the beam travels parallel to the installation surface (such as a wall, floor or ceiling), we recommend that you raise the sensor slightly off of the surface (about 50 mm). (Refer to Q8)

Front cover

Wiring length

To minimize the effects of noise, keep the wiring as short as possible. If the sensor is to be used in a high-noise environment, add capacitors to the sensor power input and the output.

Effects other than the detection area

Operating environment

Performance of power source



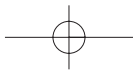

Using Sensors

Q
24

Is outdoor use possible?

See here as well!
Q9
Q25
Q27

A

Basically, you should not.

This sensor is designed for indoor use (for common indoor electronic devices). If you need to use a sensor outdoors, take measures to waterproof the sensor and protect it from dust, condensation, and freezing. There are many causes of temperature changes outdoors, and detection errors may result.



Q
25

What should be done about waterproofing?

See here as well!
Q24
Q27

A

The sensor itself is not waterproof. When incorporating the sensor into the device, design the structure to be waterproof. However, please use a material in front of the sensor such as glass or acrylic that allows the transmission of infrared rays.

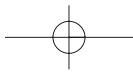

**Q
23****What is the non-sensitivity zone?**

See here as well!

Q14

Q15

Q27

A**This is the area extending from several millimetres in front of the sensor to several tens of millimetres where the sensor does not operate.**

The sensor detects the presence of an object based on the position of entry in the receiver element of the light reflected off the object. If the object is in immediate proximity to the sensor, the light emitted from the sensor does not return to the receiver element and the object is not detected. As the sensor will be incorporated into a device, it is frequently used with a front cover, and the non-sensitivity zone keeps the cover from being detected and helps the sensor operate normally.

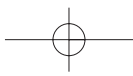
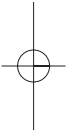
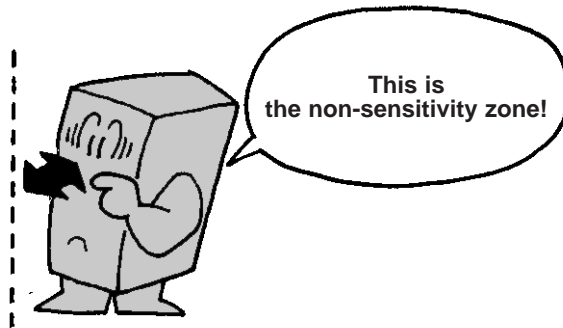

Terminology

Q
22

See here as well!

What is open collector output?

A

A transistor is used in the output. When the sensor detects a person or object, the transistor turns on and current flows from the collector to the emitter, outputting a signal.

When open collector output is used, the current flow and voltage applied to the load connected to the output can be set as desired. This enables wide range of use in sequencers and other devices.

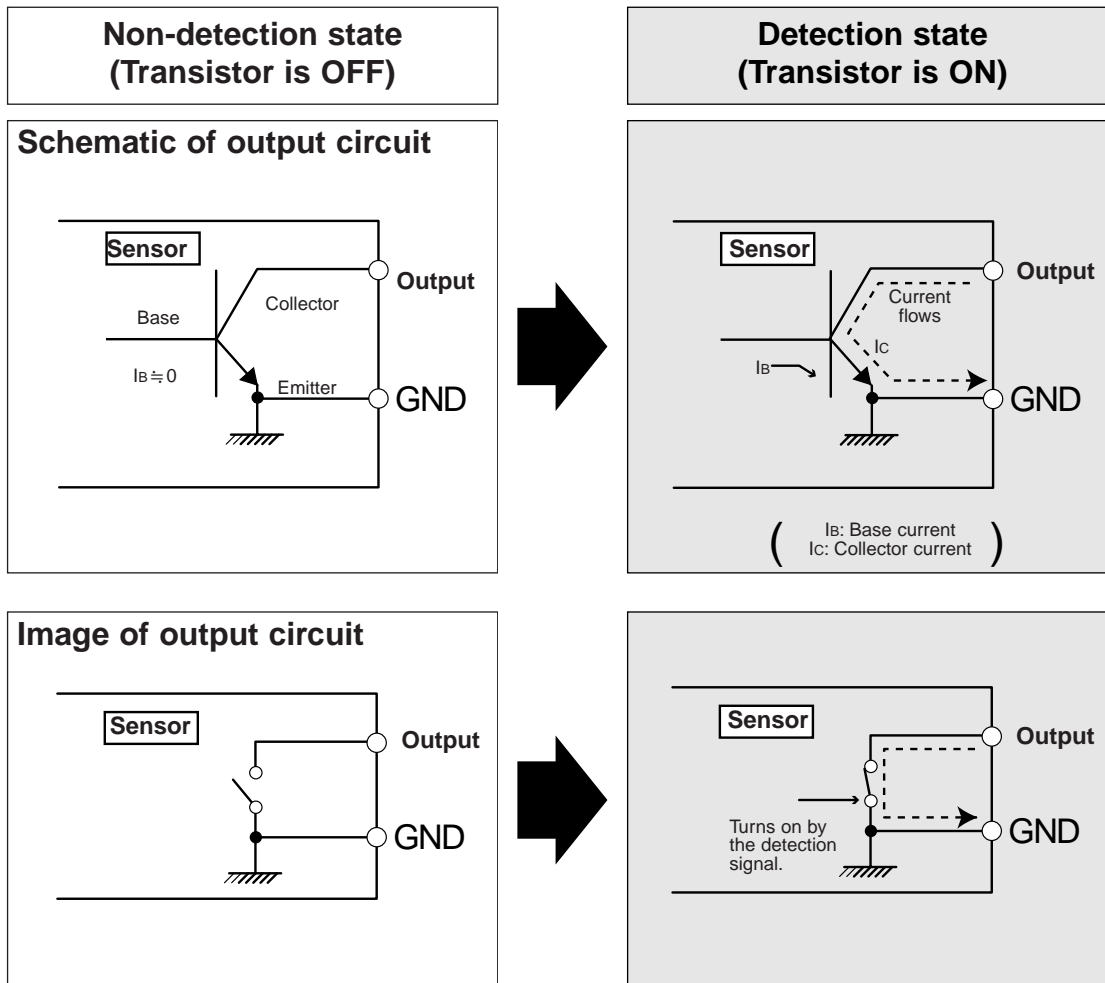
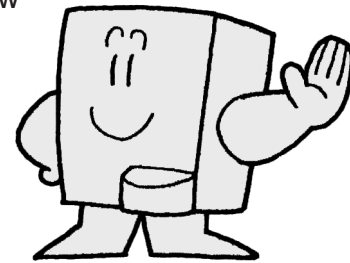

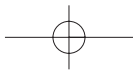

Q
19

What is your policy with respect to aging deterioration?

See here as well!

Q18

A

We estimate the life of the sensor based on testing in the operating environment of the components having the greatest effect on operation. In the case of the MA Motion Sensor, the light emitting diode has the most effect on operation. We estimate the life of the diode based on accelerated reliability tests (THB tests, etc.). The tests indicate that the sensor should operate without problem for 10 years or more, a result that past products have held up.

Q
20

How bright is 30,000 Lx?

See here as well!

Q30

A

The brightness inside a window on a clear summer day.

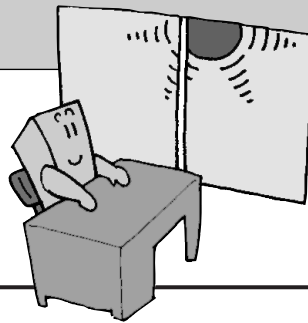

Q
21

Assuming battery power will be used, what is the life of the batteries?

See here as well!

A

Conditions

Typical current consumption over one month of use.

- 3240 mA H/month typ. (Built-in oscillation circuit type)
- 106 mA H/month typ. (External triggering type on 1 sec/time of trigger period)

<Comparative table of battery lives>

Battery type	Manufacturer	Model number	Size(one battery)	Voltage	Capacity	Life(months) of built-in oscillation circuit type	Life(months) of external triggering type
Lithium	Matsushita Battery Industrial	BR-CT2P	ø26x50	3 V (x 2 batteries)	5000 mAh	1.5	47.2
		BR-P2P	ø19.5x36x2	6 V (x 1 battery)	1200 mAh	0.4	11.3
Alkaline		LR20(PG)	ø34.2x61.5	1.5 V (x 4 batteries)	4030 mAh	1.2	38.0
Nickel cadmium	Sanyo Electric	N-4000D	ø34x61	1.2 V (x 5 batteries)	4000 mAh	1.2	37.7

If you need a low current consumption battery, please consult us.

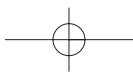

MA Motion Sensor Questions and Answers Performance

Q
16

How long does it take (response time) for the detection signal to be output after a person or object enters the detection area?

See here as well!

A

A maximum of 9 ms.

The built-in oscillation circuit type is set to measure at a maximum period of 9 ms, and thus the response time is a maximum of 9 ms. However, the average is about 8 ms.

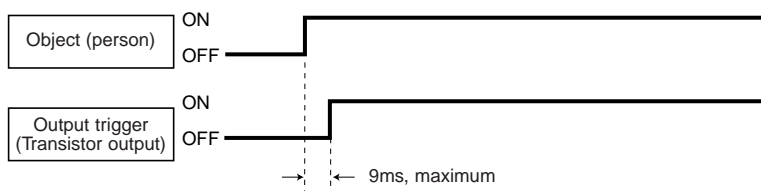

Q
17

If the detection state persists, what happens to the output?

See here as well!

A

The output remains in the ON state.

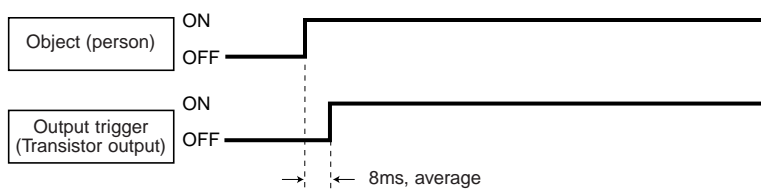

Q
18

Does the sensor have good weather resistance?

See here as well!

Q19
Q24

A

The front window of the MA Motion Sensor is made with polycarbonite. This plastic has particularly superb weather resistance even compared to other plastics.

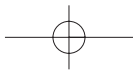

Q
15

What are the characteristics of the detection area?

See here as well!

Q13

Q14

Q23

A

The characteristics are shown in the following diagrams.

Reading the graph

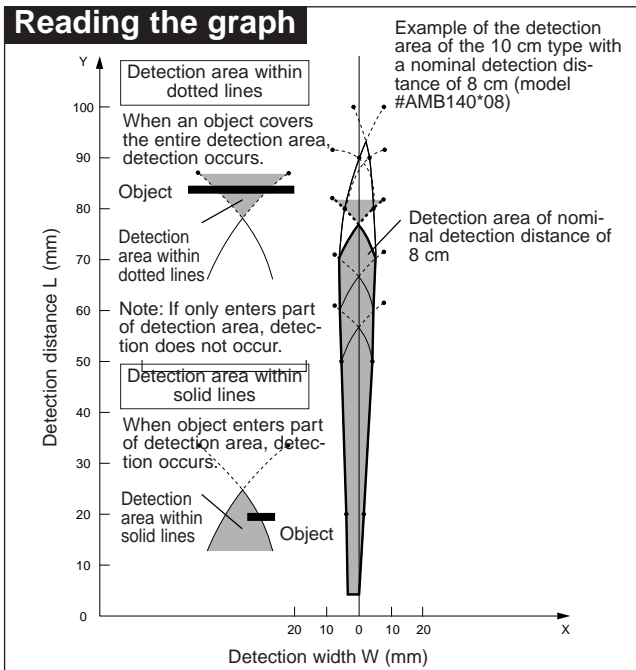

Short type (AMB14**)**

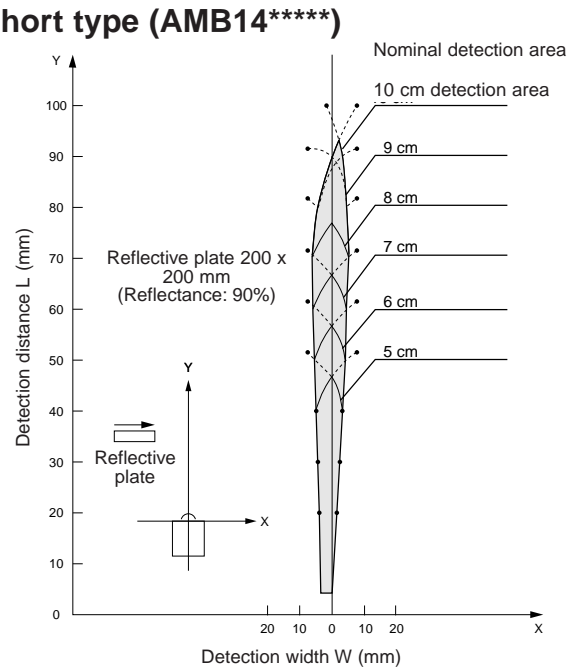

Middle type (AMB24**)**

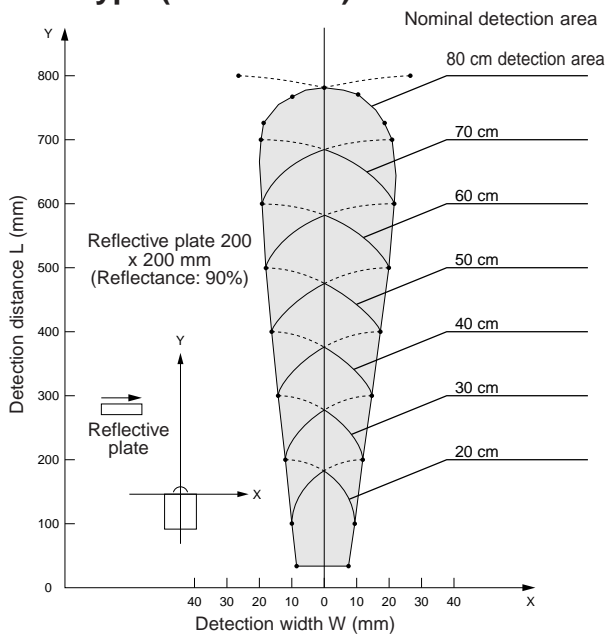

Long type (AMB34**)**

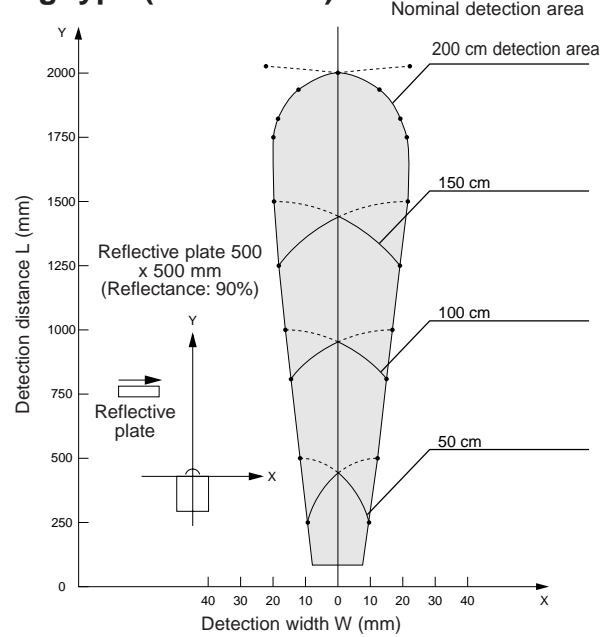

Q
14

Can detection take place when the object is closer than the rated detection distance?

See here as well!

Q13
Q15
Q23

A

Yes.

The sensor emits an infrared beam, measures the distance to the person (object) by means of the light reflected back, and determines whether or not the object is within the detection distance.

However, with the exception of the non-sensitive zone in the immediate proximity of the sensor where light reflected off the object cannot return to the receiver lens, the sensor detects objects anywhere within the rated detection distance.

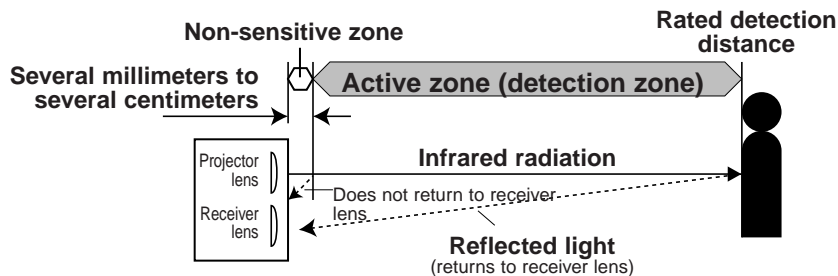

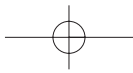

Q
12

Does temperature affect the detection distance?

See here as well!

Q13

A

Yes.

The area reflective type MA Motion Sensor detects an object based on the position of the infrared beam that reflects off of the object and returns to the sensor. When the temperature changes, differences in the coefficients of linear expansion of the sensor components can cause the distance between the lenses, and the distance between the projector and receiver elements, to expand or contract. This changes the position of the returning infrared beam and thus the detection distance.

The amount of the change is several percent over the operating temperature range of the sensor (-25°C to 75°C).

Q
13

Is it possible to select a new setting for the detection distance after receiving the sensor?

See here as well!

Q12

Q14

Q15

A

No, you cannot set the detection distance once the sensor has been shipped from the factory.

The rated detection distance is determined by the lens position adjustment. Since this procedure is done at the factory before shipping you cannot set this afterwards once the sensor has been shipped. Please select a sensor according to your application with the appropriate detection distance from the products provided below.

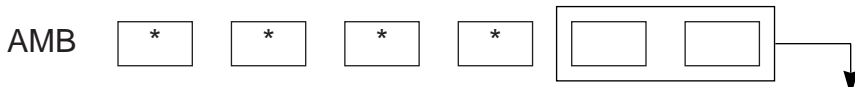

Rated detection distance

Area reflective type MA Motion Sensor				
Model number	Type	Short type	Middle type	Long type
02		-	20 cm	-
03		-	30 cm	30 cm
04		-	40 cm	40 cm
05		5 cm	50 cm	50 cm
06		6 cm	60 cm	60 cm
07		7 cm	70 cm	70 cm
08 (No display on middle type)		8 cm	80 cm	80 cm
09		9 cm	-	90 cm
10 (No display on short type)		10 cm	-	100 cm
11		11 cm (Note)	-	110 cm
12		12 cm (Note)	-	120 cm
13		13 cm (Note)	-	130 cm
14		14 cm (Note)	-	140 cm
15		15 cm (Note)	-	150 cm
16		-	-	160 cm
17		-	-	170 cm
18		-	-	180 cm
19		-	-	190 cm
20 (No display on long type)		-	-	200 cm

Note:
Not kept in stock.
Please consult us.

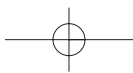

MA Motion Sensor Questions and Answers Performance

**Q
9**

Does dirt on the front cover (filter) affect performance?

See here as well!

Q24
Q27
Q28

A

Dirt has almost no effect.

The MA Motion Sensor takes the detected difference in distance between an object with 90% reflectance and an object with 18% reflectance as "distance measurement error". Even if the reflected light intensity decreases to 1/5 its original value due to dirt, the distance measurement error will still be under this value.

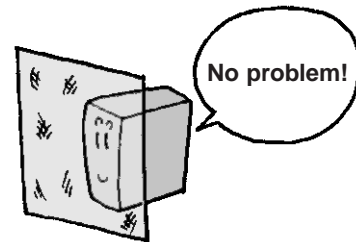

**Q
10**

What is the output wavelength of the sensor's infrared LED?

See here as well!

Q11

A

The output reaches a momentary (max. 10 μ s) power of 180 mW, and the wavelength is approximately 900 nm. This is about the same as a typical remote control.

**Q
11**

Does a remote control ever cause detection errors?

See here as well!

A

The sensor uses the same type of light emitting element as a remote control, and as such detection errors are possible. However, to produce a detection error the following conditions must be met:

- * The remote control must be within the field of detection of the sensor.
- * The timing of remote control operation must coincide with the interval of several tens of microseconds that the MA Motion Sensor accepts light.
- * Sufficient power is required.

Due to these conditions, random operation of a remote control pointed toward the MA Motion Sensor will result in erroneous detection only once every several tens of times.

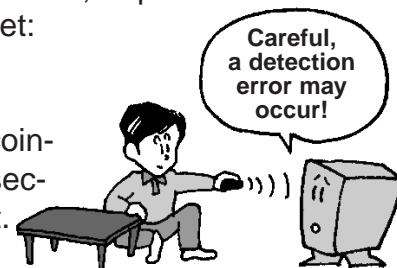

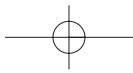

Q8

Why is a detection signal output even though no object is in the detection area?

See here as well!

- Q7 Q26
- Q9 Q27
- Q11 Q28
- Q12

A

1. Is there anything in front of the MA Motion Sensor with a reflective surface such as a mirror, metallic plate, or marble?

Just as light reflects in a mirror, the infrared light emitted by the sensor will reflect off of an object with a reflective surface and return to the sensor. If this occurs, change the angle of attachment of the sensor slightly (no more than several degrees) as shown below.

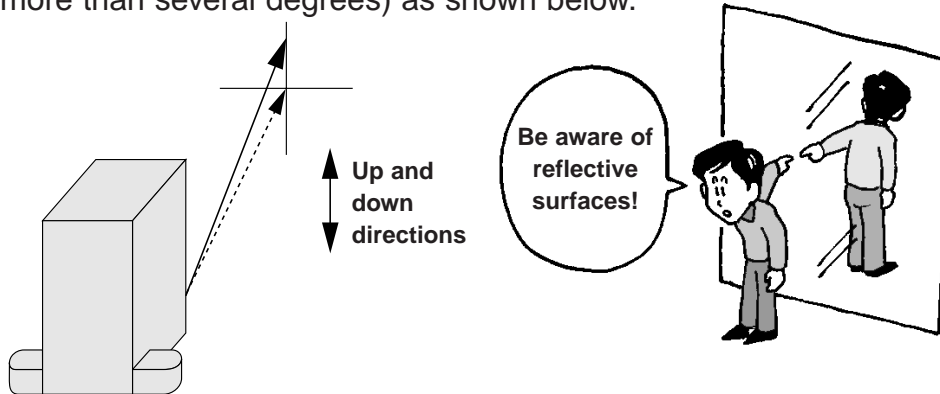

2. Is the sensor detecting the surface on which it is installed?

The sensor emits infrared light in the form of a spot beam that gradually expands. The beam projector element is in the bottom part of the sensor, and thus if the sensor is installed on a surface parallel to the beam (wall, floor or ceiling), the beam may hit the surface and reflect back into the sensor. We recommend that you raise the sensor slightly off of the installation surface (approx. 50mm).

Detection error

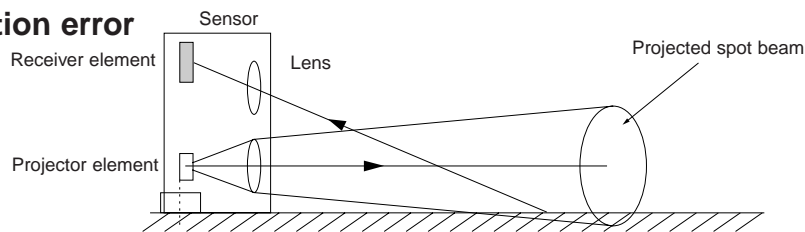

Recommended installation

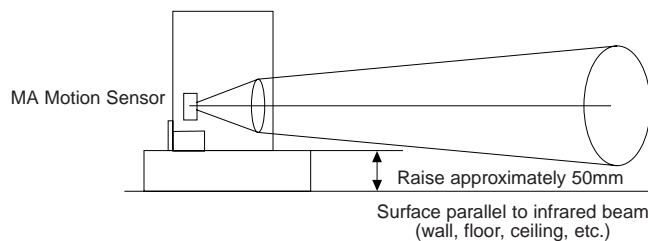

Performance

**Q
7**

Is detection performance affected by the type of clothing worn?

See here as well!
Q8

A

The effect of clothing is negligible.

Light intensity type sensors, which have been in common use, detect an object based on the amount of reflected light and for this reason tend to be affected by the type of clothing worn. The MA Motion Sensor is a distance measurement type sensor, and variations in the detected distance due to differences in clothing material or color are negligible.

Stable detection is possible of objects having a reflectance ranging from 90% to 18%.

The reflectance of clothing and body parts is indicated below.

<p>Detectable objects</p>	<ul style="list-style-type: none"> * Objects with a high reflectance White cloth, white shirts, white sport shirts * Intermediate objects Objects with a colored pattern * Objects with a low reflectance Black formal clothing, fluffy or furry materials such as black fur, lustrous materials such as black lame
<p>Objects that cannot be detected</p>	<p>Mirrors, objects with metallic coating, mirror-like objects in which you can see your reflection (black car body, metal plates)</p>

Reference:

Reflectance of human skin: Approximately 40%

Reflectance of hair: 3% to 40% (average 5%)

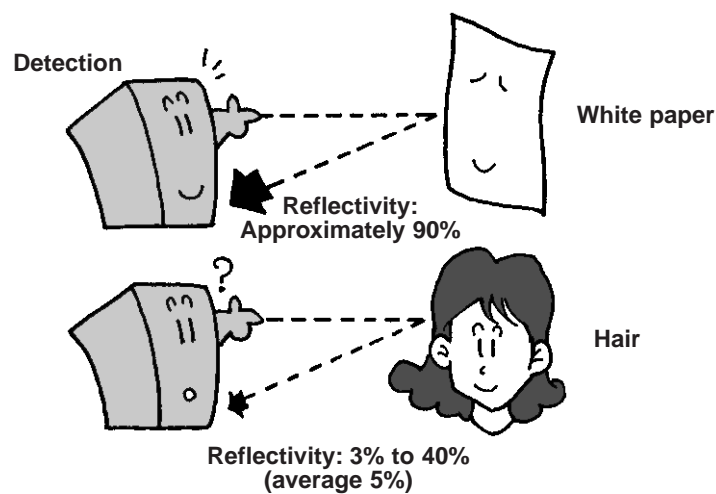
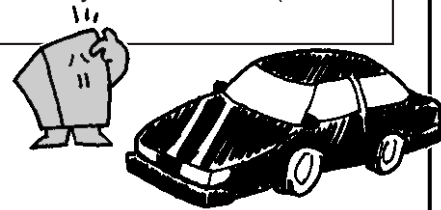

**Q
6**

I need to design pulse generating circuit using the external trigger type. Could you show an example drive circuit?

See here as well!

Q7

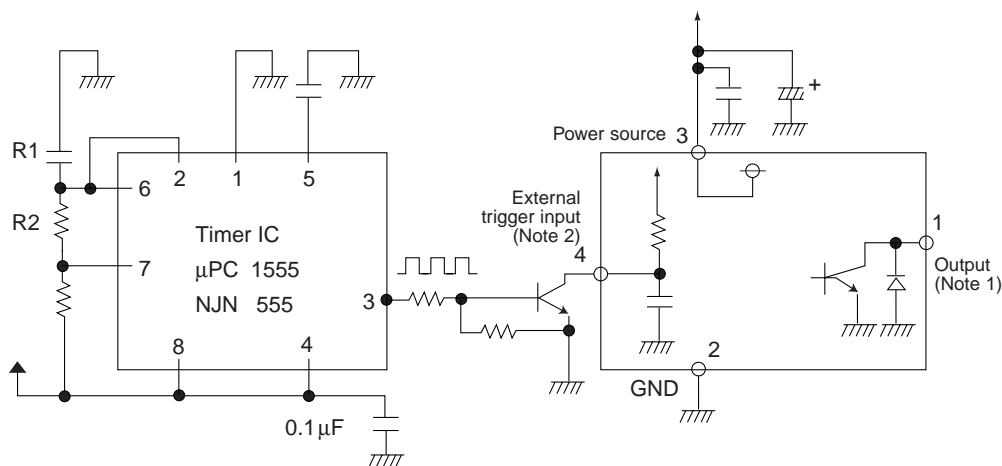
A**Example drive circuit**

Notes: 1. The output transistor has an open collector structure.
 Detection status: Output transistor ON (connected to GND)
 Non-detection status: Output transistor OFF (open state)

Notes: 2. The status of the external trigger input is as follows:
 Open at the high level
 GND (less than 0.8V) at the low level
 Under no circumstances must a high-level voltage be applied.

Notes:

This is a sample circuit for driving an MA Motion Sensor. Noise protection was not taken into consideration.

To increase reliability and protect against noise, add a noise filter to the input. In addition, add a circuit that accepts the output in synchronization with the start signal and issues a detection signal when the same output is repeated several times in succession.

Please note that we bear no responsibility for any damages or loss arising from the use of this circuit.

**Q
4**

Can a power source voltage other than 5 V be used?

See here as well!

A

Yes.

Two types are available:

- 1) 5V DC type (4.5 V to 6.5 V DC)
- 2) Free power source type (6.5 V to 27 V DC)

These two types provide compatibility with most common electronic devices.

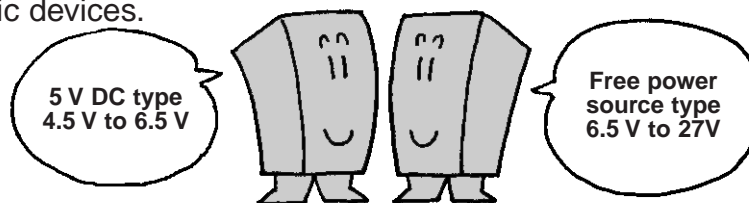
**Q
5**

I would like to extend the wiring to 3 meters. Is this possible?

See here as well!

Q26

A

In order to protect the internal circuit and reduce the influence of noise from the surrounding environment keep the wiring as short as possible within three meters. If inverters, motors, switching devices, or other devices are in close proximity, special caution is needed. If the sensor is going to be used in an environment with considerable noise, add a capacitor to the power input pin of the sensor.

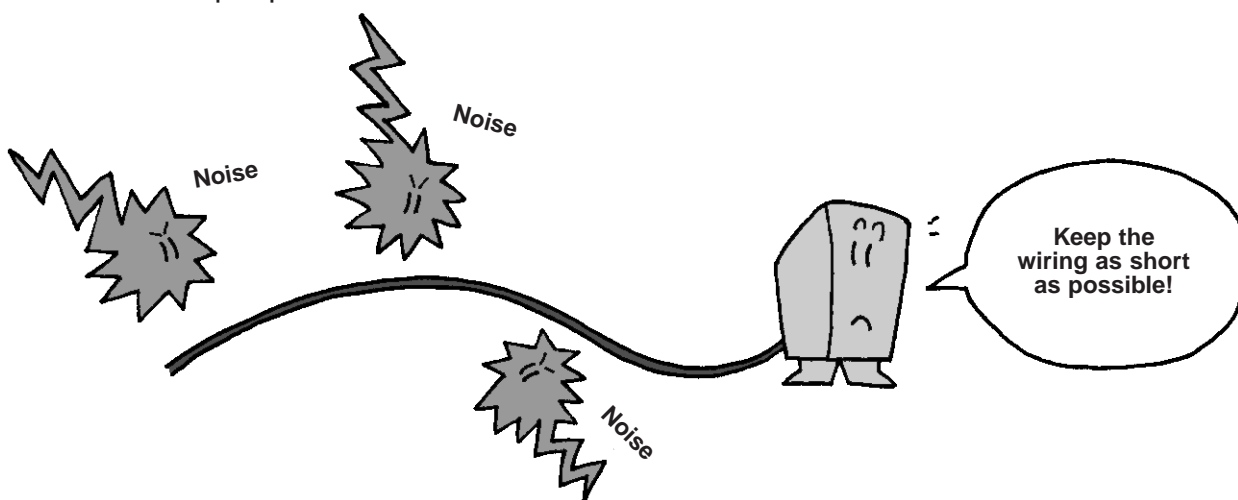

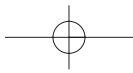

Q3

What kind of circuit should be used to set the time (timer time) of the output signal?

See here as well!
Q2

A

Refer to the following circuit.

Example of a relay drive circuit using a timer circuit

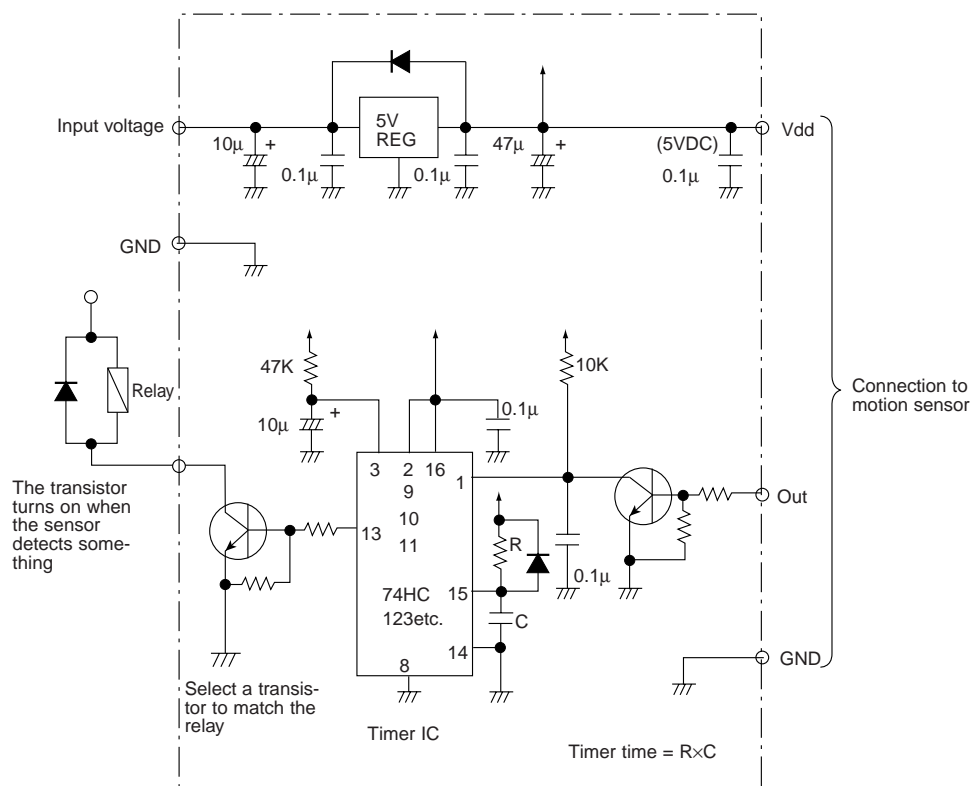

Note 1) Each timer IC manufacturer requires different values for the resistance (R) and capacitance (C) used for the time setting. Check with the manufacturer for these values before designing the circuit.

Note 2) This circuit is an example circuit for driving the MA Motion Sensor. Please note that we bear no responsibility for any damages or loss arising from the use of this circuit. To increase reliability and noise tolerance, add noise filter. Note that specification changes in the electronic components may prevent the circuit from operating correctly. Be sure to verify performance and reliability when designing the circuit.

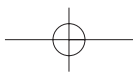

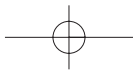

Area reflective type MA Motion Sensor

Circuitry

Q1

I would like to use two sensors simultaneously to expand the detection area. Will the sensors interfere with each other?

See here as well!

A

Yes. In order to avoid reciprocal interference when emissions occur simultaneously, install the MA motion sensors (built-in oscillation circuit type) with the following spacing, or use an external trigger type for which operation can be adjusted by the trigger signal input.

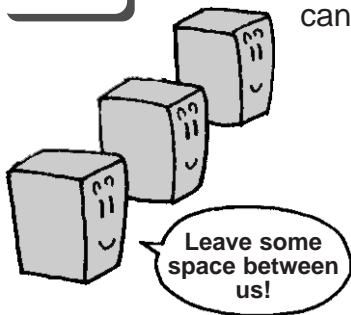

Product number	AMB1***	AMB2***	AMB3***
Standard detection distance	Short type	Middle type	Long type
Distance between sensors	5 cm	10 cm	20 cm

Q2

How should I design the circuit for output using a relay?

See here as well!
Q3

A

Refer to the following circuits

1. Mechanical relay drive

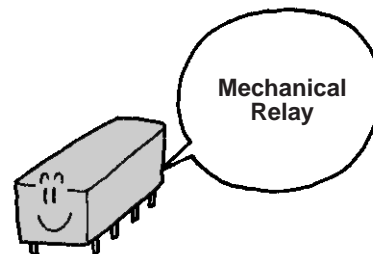
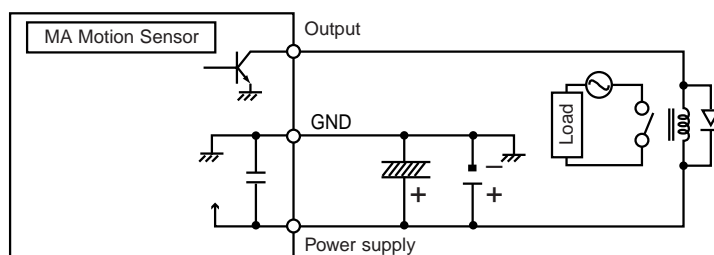

2. For SSR drive

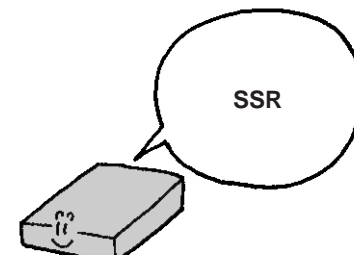
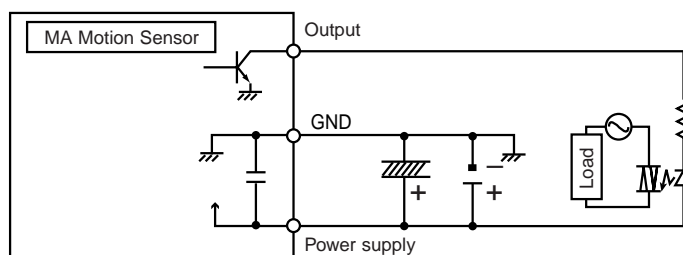

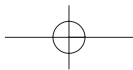

Q
46

Is detection performance affected by clothing?

See here as well!

Q20 Q43
Q21 Q44

A

Performance is slightly affected.

The MP Motion Sensor detects the difference between the ambient temperature and the surface temperature of a person that enters the sensor detection area; thus detection performance is slightly affected by the condition of the person and the ambient temperature. The human body emits more energy in the summer when people tend to wear clothing that exposes more of the body than in the winter, when only the face and hands may be exposed. However, actual detection performance is better in the winter because the lower ambient temperature has a greater effect on performance than the presence of more clothing. In general, changes in the ambient temperature are of greater concern than clothing.

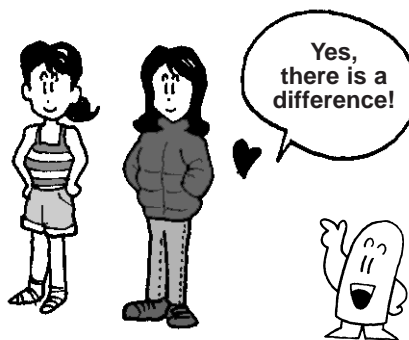

Q
47

Is there an easy way to verify sensor operation?

See here as well!

Q1
Q26

A

Connect the sensor as shown here to have an LED illuminate when the sensor detects a person.

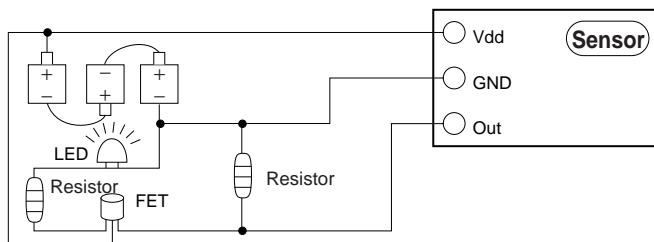

*1 Use a resistor value appropriate for the current that is to flow through the LED.

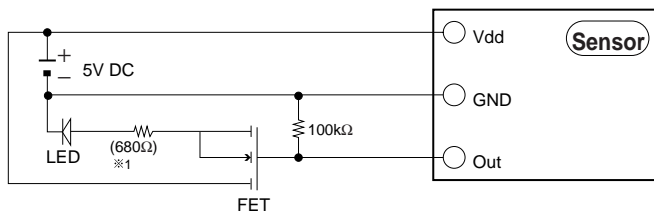



MP Motion Sensor 'N a P i O n' Questions and Answers Using Sensors

Q
43

Does the ambient temperature affect detection sensitivity?

See here as well!

Q20	Q23
Q21	Q46
Q22	

A

Yes.

Seasonal changes in the ambient temperature change the sensitivity of the sensor. Detection becomes more difficult in the summer because there is less difference between the ambient temperature and the surface of the human body. In winter, the reverse is true.

Q
44

Does detection take place when the ambient temperature is higher than the human body? How about when the ambient temperature is the same as the human body?

See here as well!

Q20	Q22
Q21	Q23

A

Yes.

The sensor operates by detecting temperature changes caused by the motion of a body of a different temperature than the ambient temperature. Therefore, detection takes place when the ambient temperature is higher than the human body. Detection is also possible even when the ambient temperature is the same as the human body because not all parts of the body are the same temperature and the differences are detected when the body moves.

Q
45

Does sunlight affect performance?

See here as well!

Q20
Q21
Q33

A

Yes.

When the sun suddenly shines or stops shining on the sensor, temperature changes occur. The sensor detects these changes and may output a detection signal. Be sure to install the sensor in a location not exposed to sunlight.

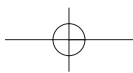
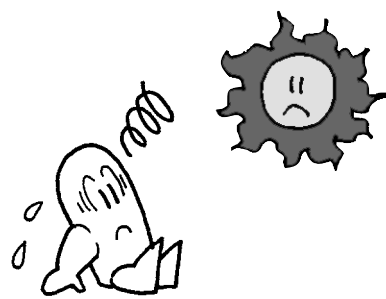

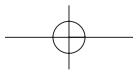

Q
41

I would like to detect small animals like mice. What is the smallest object that can be detected?

See here as well!

Q40

A

The minimum detection size is that of one multi-lens (a circle several millimetres in diameter) when the object is in immediate proximity to the MP Motion Sensor.

Detection takes place when the object blocks part of the detection area and a temperature difference occurs. As the distance from the sensor increases, the detection area grows, and a larger object is necessary to create the temperature difference needed for detection.

The minimum detection size depends on the distance from the object to the sensor and the magnitude of the temperature difference. Use the sizes indicated in the following x-y cross-section diagram as a reference.

Standard type

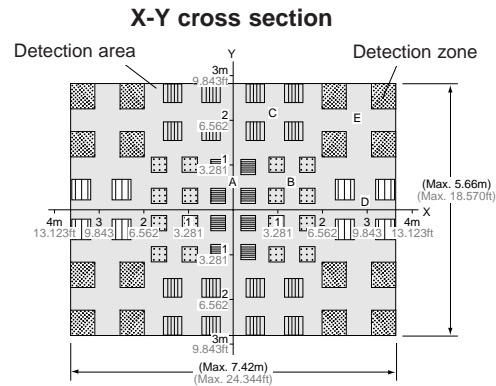
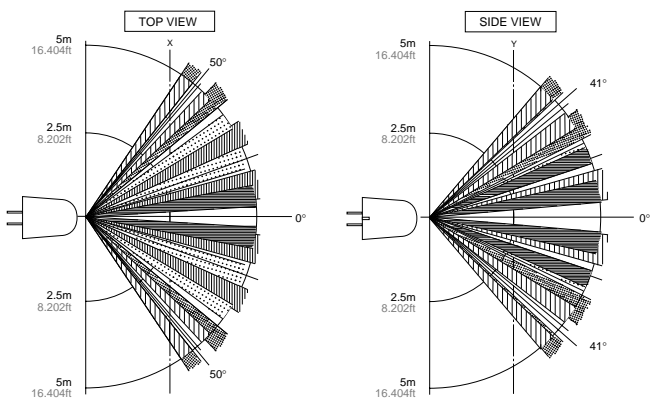

The sensor turns on (activates) when a temperature change occurs in one or more of the above detection zones.

Q
42

Will objects behind transparent panes such as glass or acrylic be detected?

See here as well!

Q10

Q11

Q36

A

No.

The sensor can only detect wavelengths that are 5 μm or longer.

Common materials such as glass can only transmit near infrared wavelengths up to 2 μm, thus a person moving behind a glass window will not be detected.

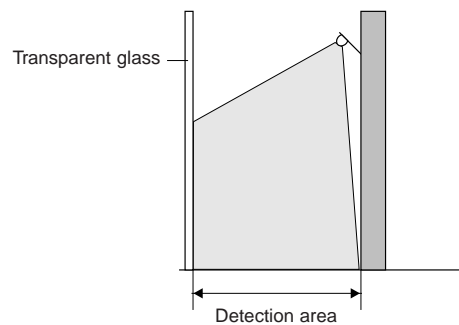

MP Motion Sensor 'N a P i O n' Questions and Answers Using Sensors

Q
38

Can a sleeping person be detected?

See here as well!

Q32
Q39

A

A person who remains completely still cannot be detected.

However, detection is possible in the following instances:

(Use the slight motion type)

- * Someone who frequently turns over in their sleep.
- * Someone sleeping in bed who occasionally moves his or her feet or hands.
- * The frequency of movement can be used to detect whether the person is awake or asleep.

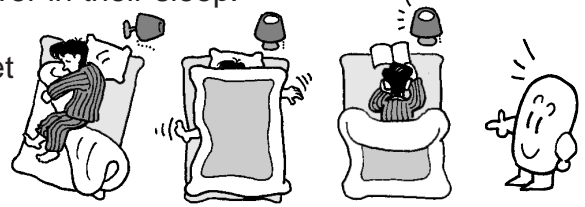

(To detect someone who is lying completely still, use an area reflective type MA motion sensor.)

Q
39

I need to detect both moving people and people standing still.

See here as well!

Q32
Q38

A

Use the high-sensitivity slight motion type.

Detection of a moving person is easy (standard function). Although it is not possible to detect someone who is standing completely still, people almost never remain completely still. Even the slightest movement can be detected by the sensor. The slight motion type is designed for the purpose of detecting slight movements of the hands and head.

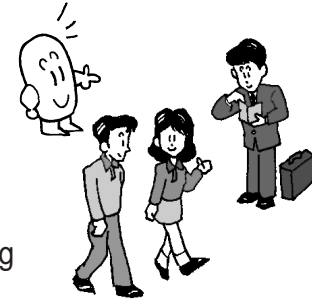

Q
40

Is detection possible when the distance between the person and the sensor is almost zero?

See here as well!

Q10
Q41

A

Yes.

If a person enters the detection area, detection occurs. However, if the person is very close to the sensor, the person may cover the detection area and prevent the occurrence of temperature changes. In this case, detection will not occur.



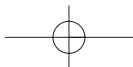

Q
36

How can I change the detection area?

See here as well!

Q9 Q11
Q10 Q42

A

The detection area can be changed by changing the angle of attachment of the sensor, and by placing a slit in front of the sensor that limits the area detected. If you find it difficult to calculate the desired detection area, please consult us.

Setting the sensor so it will not detect people who are far away

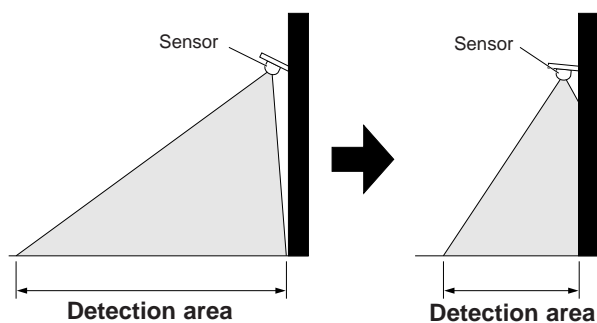

For detection in only a limited area

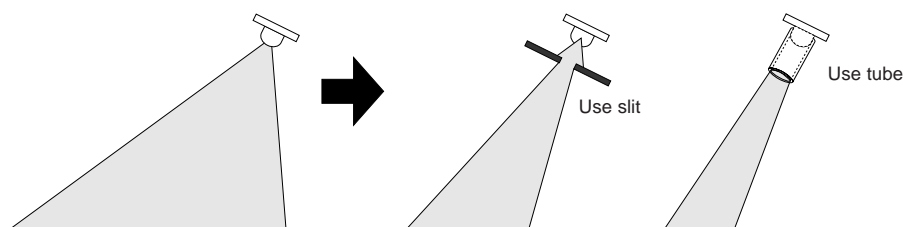

Q
37

Can the sensor be installed on a moving body?

See here as well!

Q20

A

No.

The MP Motion Sensor is normally installed in a static location. When an object enters the detection area, the sensor detects changes in the amount of infrared radiation in the detection area. If the sensor were to move, it might mistake changes in the wall and floor temperature for a moving object of a different temperature and activate.



MP Motion Sensor 'N a P i O n' Questions and Answers Using Sensors

Q
34

How should the sensor be waterproofed?

See here as well!

Q13 Q42
Q33 Q45
Q35

A

The sensor itself is not waterproof. The following is an example of how it can be waterproofed.

General waterproofing example

Cover the entire sensor with a box, and use a polyethylene sheet for the front face. The thickness of the polyethylene sheet should be no more than 0.5 mm. If any thicker, the sensitivity of the sensor will drop by more than half.

Caution:

Sensitivity will fall. Be sure to verify that the sensor performs as desired in the actual conditions of use.

Polyethylene sheet

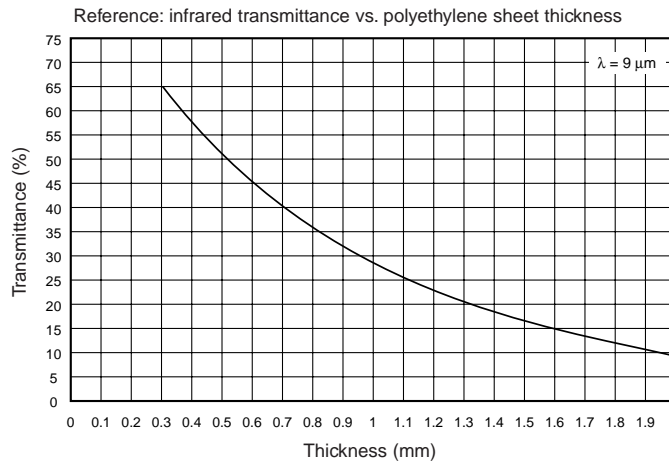
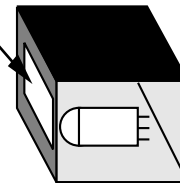

Q
35

Does condensation ever form inside the metal package of the sensor?

See here as well!

Q33
Q34

A

In general, no. However, be sure to perform performance and reliability tests in the operating environment before commencing design.

Dry air is sealed into the metal can package of the sensor, thus there is in general almost no moisture inside the metal can. However, if the sensor is to be used outdoors, take sufficient measures for waterproofing and protection against dust, condensation and freezing.

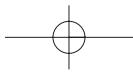

Using Sensors

Q
32

What is the difference between the standard type and the slight motion type?

See here as well!
Q38
Q39

A

In general the standard type is for detection of large-scale motion, such as a person walking. The slight motion type is for small-scale movement such as slight movements of the hands or head of a person sitting. When you need uniform detection sensitivity over a wide, far-reaching area, use the standard type. When you need to detect people that are sitting and barely move such as in a conference room or office, or people that move only slightly, use the slight motion type.

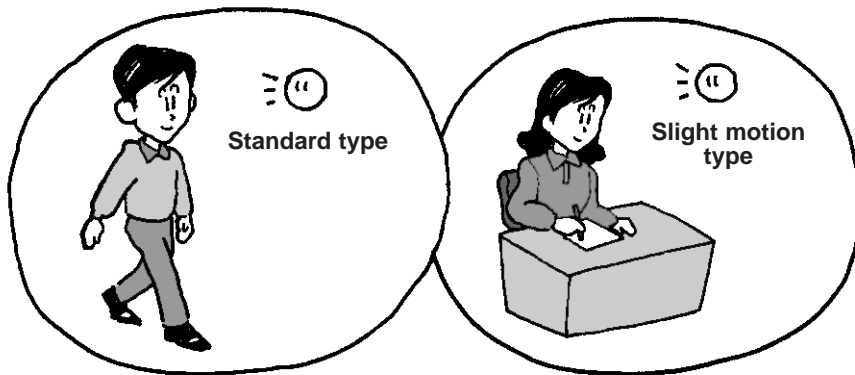

Q
33

Is outdoor use possible?

See here as well!
Q24 Q35
Q34 Q45

A

Basically, you should not.

MP motion sensors are designed for indoor use (for common indoor electronic devices). If you need to use a sensor outdoors, take measures to waterproof the sensor and protect it from dust, condensation, and freezing. There are many causes of temperature changes outdoors, and detection errors may result.

A typical outdoor application is entry light control. In this case the sensor is normally in close proximity to a wall and roof which help to limit temperature changes, and operation takes place at night when the temperature remains fairly uniform.

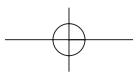
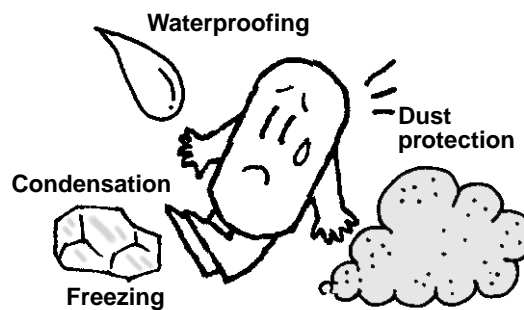

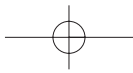

MP Motion Sensor 'N a P i o n' Questions and Answers Terminology

Q
30

See here as well!

What is a comparator?

A

The amount of infrared radiation emitted from the human body is very small, and the signal cannot be processed by the circuit as is. For this reason, the signal is amplified by the amplifier circuit. The amplified signal must then be compared to the reference level. If the amplified circuit is greater than the reference level, a person is considered to have entered the detection area and a signal is output. **The circuit that makes this comparison is called a comparator.**

<Timing chart> Standard type

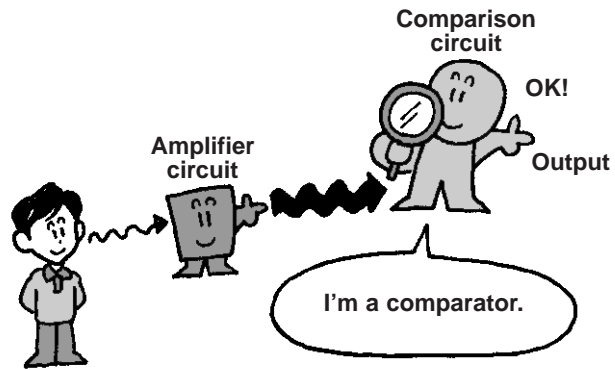
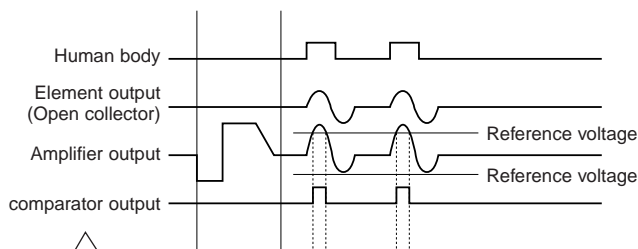

Q
31

See here as well!

When does current consumption standby occur?

A

When the time required for stabilization has elapsed and the sensor is ready for detection, two states are possible depending the condition of the detection area:

1. A person has entered the detection area (detection output ON)
2. Nobody is in the detection area (detection output OFF)

Number 2 above is the standby state. (Number 1 is the detection state.) The difference between the standby state and the detection state is that the output circuit is off in the standby state, and therefore current consumption is less than in the detection state.

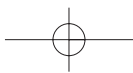
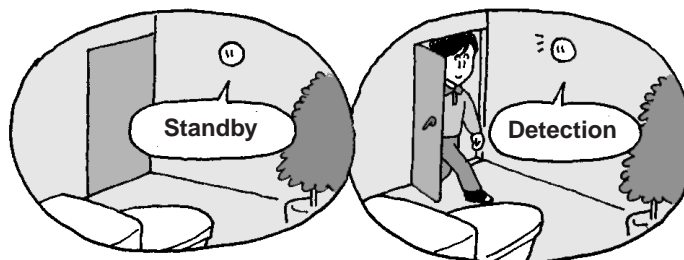

Terminology

Q
28

What is a passive infrared element?

See here as well!

A

This is a sensor element whose surface is pre-charged. The charge changes due to infrared radiation from the object detected, and the change is output as a voltage change.

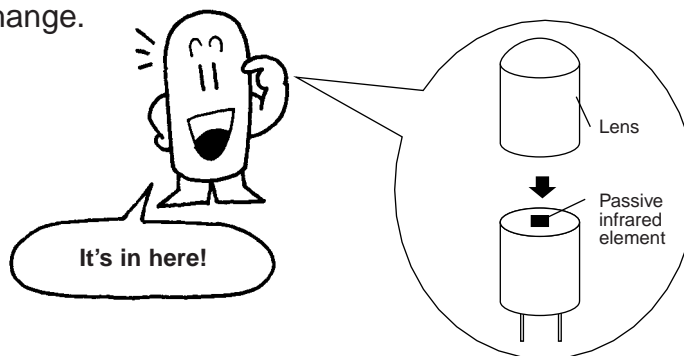

Q
29

What is a TO5 metal package?

See here as well!

A

As shown at right, a TO5 package consists of a metal semiconductor chip mounting 9 mm in diameter, a dooshshaped component called a stem that holds the external leads, and a metal cap that covers the semiconductor chip.

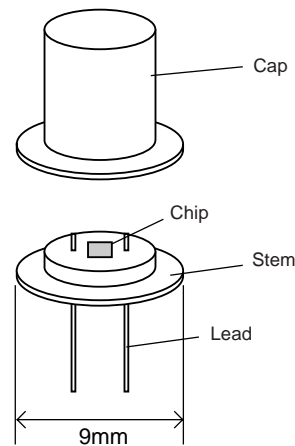

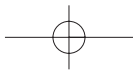

MP Motion Sensor 'N a P i O n' Questions and Answers Performance

Q
25

What is the tolerance to external surges and noise?

See here as well!

A

Noise (noise components) from the ambient environment and power supply will affect operation.

Use the sensor in an environment with as little noise as possible.

Reference:

Distance at which cellular telephone noise does not affect sensor: 1 to 2 cm or greater

Q
26

What is your policy with respect to age deterioration?

See here as well!

A

We estimate the age deterioration in the operating environment of the sensor based on testing of the components having the greatest effect on operation.

In the case of the NpPiOn sensor, the passive infrared elements have the most effect on operation. We estimate the age deterioration of the sensor based on accelerated reliability tests (THB tests, etc.). The test results indicate that the sensor should operate without problem at normal room temperature and humidity for 10 years or more.

Q
27

Assuming battery power will be used, what is the life of the batteries?

See here as well!

A

*Duration of battery use (per month): 24 hours per day, 30 days per month

*Sensor detection frequency: 4000 times per month (5 to 6 times per hour)

Detection output time: 1 minute per detection

*Using a 5000 mAh lithium battery: 3.2 years

*Using a 1200 mAh lithium battery: 9.3 months

Current consumption	
Standby	During detection
170µA (typ.)	270µA (typ.) Output (when at 100µA)



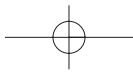

Q
22

The maximum operating ambient temperature is given as 60°C. The sensor cannot be used at a higher temperature?

See here as well!

Q23
Q43
Q44

A

No, the standard product cannot be used at a higher temperature.

The operating ambient temperature range is -20°C to +60°C.



Q
23

What will happen if a sensor is used outside of the operating ambient temperature range?

See here as well!

Q22
Q43
Q44

A

A detection signal may be output even though nothing is detected.

Or, a detection signal may not be output even though a person is detected. (Performance cannot be guaranteed.) The operating ambient temperature range is -20°C to +60°C.

Q
24

What will happen if dirt or dust gathers on the sensor surface?

See here as well!

Q33

A

Dust has hardly any effect on sensor operation.

However, a large piece of debris that covers part of the lens surface will interfere with operation.

No problem with dust or small debris!

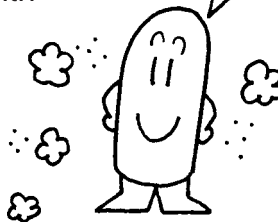

Reliability Data of MA Motion Sensor

Conditions of measurement: temperature = $25 \pm 5^\circ\text{C}$, humidity = 40 to 70%, air pressure = 86 to 106 kPa

Tested characteristic	Test conditions	Pass/fail criteria	Test result
Heat resistance	Temperature: $85 \pm 3^\circ\text{C}$ Test time: 96 hours	After test: Change in detection distance performance is no more than $\pm 30\%$ of initial value. Visual inspection reveals no structural abnormalities.	Number of pieces tested: n = 6 Defective pieces: c = 0 Passed
Resistance to thermal shock	Low temperature: $-30 \pm 3^\circ\text{C}$ High temperature: $85 \pm 3^\circ\text{C}$ Time of one cycle: 30 minutes each for high and low temperatures Number of cycles: 100	After test: Change in detection distance performance is no more than $\pm 30\%$ of initial value. Visual inspection reveals no structural abnormalities.	Number of pieces tested: n = 6 Defective pieces: c = 0 Passed
Low temperature resistance	Temperature: $-30 \pm 3^\circ\text{C}$ Test time: 96 hours	After test: Change in detection distance performance is no more than $\pm 30\%$ of initial value. Visual inspection reveals no structural abnormalities.	Number of pieces tested: n = 6 Defective pieces: c = 0 Passed
Operating temperature range	Low temperature limit: $-25 \pm 3^\circ\text{C}$ High temperature limit: $75 \pm 3^\circ\text{C}$	During test: no errors, operation failures, or damage. Change in detection distance performance is no more than $\pm 20\%$ of the value at 25°C .	Number of pieces tested: n = 6 Defective pieces: c = 0 Passed
Temperature/humidity cycle	Temperature: $-10 \pm 3^\circ\text{C}$ to $65 \pm 3^\circ\text{C}$ Humidity: 90% Time of one cycle: 24 hours Number of cycles: 10	After test: Change in detection distance performance is no more than $\pm 30\%$ of initial value. Visual inspection reveals no structural abnormalities.	Number of pieces tested: n = 6 Defective pieces: c = 0 Passed
Vibration resistance	Vibration frequency: 10 to 55 Hz Amplitude: 1.5 mm Direction of application: 3 directions Application time: 30 minutes each directions	After test: Change in detection distance performance is no more than $\pm 30\%$ of initial value. Visual inspection reveals no structural abnormalities.	Number of pieces tested: n = 6 Defective pieces: c = 0 Passed
Shock resistance	Shock value: 100 G Direction of application: 3 directions Application times: 3 times each	After test: Change in detection distance performance is no more than $\pm 30\%$ of initial value. Visual inspection reveals no structural abnormalities.	Number of pieces tested: n = 6 Defective pieces: c = 0 Passed
Output characteristics	Power source voltage: Nominal power source voltage Output load voltage: 30 V DC	Leakage current: 3 μA or less (Measured with micro-ammeter when output Tr is OFF)	Number of pieces tested: n = 3 Defective pieces: c = 0 Passed
Dropping tolerance (No Packing)	Height: 80 cm Direction of drop: 6 directions Number of times: Once each direction Drop surface: vinyl chloride tile	After test: No destruction. Visual inspection reveals no structural abnormalities.	Number of pieces tested: n = 6 Defective pieces: c = 0 Passed

Looking for pricing, stock, or lifecycle information?

Click below to explore more details on WIN SOURCE:

 [View AMN44122 on WIN SOURCE](#)

 [Panasonic Information](#)

Optimize Your Supply Chain with WIN SOURCE Solutions

-  Global Sourcing Solution
-  Obsolete Management
-  Cost Control Management
-  Shortage Management
-  Alternative Solution
-  Excess Inventory Management