



**THE DATASHEET OF  
SN74HC132PWRG4**



## SNx4HC132 Quadruple Positive-NAND Gates With Schmitt-Trigger Inputs

### 1 Features

- Wide Operating Voltage Range of 2 V to 6 V
- Outputs Can Drive up to 10 LSTTL Loads
- Low Power Consumption, 20- $\mu$ A Maximum  $I_{CC}$
- Typical  $t_{pd} = 14$  ns
- $\pm 4$ -mA Output Drive at 5 V
- Low Input Current of 1  $\mu$ A Maximum
- Operation from Very Slow Input Transitions
- Temperature-Compensated Threshold Levels
- High Noise Immunity
- Same Pinouts as SN74HC00

### 2 Applications

- Electronic Points-of-Sale
- Telecom Infrastructure
- Network Switches
- Tests and Measurements

### 3 Description

The SNx4HC132 device functions as a NAND gate, but because of the Schmitt action, it has different input threshold levels for positive and negative going signals. The SNx4HC132 devices perform the Boolean function

$$Y = A \cdot B \text{ or } Y = \bar{A} + \bar{B} \text{ in positive logic.}$$

These circuits are temperature compensated and can be triggered from the slowest of input ramps and still give clean jitter-free output signals.

#### Device Information<sup>(1)</sup>

| PART NUMBER | PACKAGE (PINS) | BODY SIZE (NOM)    |
|-------------|----------------|--------------------|
| SN54HC132J  | CDIP (14)      | 19.56 mm x 6.67 mm |
| SN74HC132D  | SOIC (14)      | 4.90 mm x 3.91 mm  |
| SN74HC132N  | PDIP (14)      | 19.30 mm x 6.35 mm |
| SN54HC132FK | LCCC (20)      | 8.89 mm x 8.89 mm  |
| SN54HC132W  | CFP (14)       | 9.21 mm x 5.97 mm  |
| SN74HC132PW | TSSOP (14)     | 5.00 mm x 4.40 mm  |
| SN74HC132NS | SO (14)        | 10.30 mm x 5.30 mm |
| SN74HC132DB | SSOP (14)      | 6.20 mm x 5.30 mm  |

(1) For all available packages, see the orderable addendum at the end of the data sheet.

#### Logic Diagram (Positive Logic)

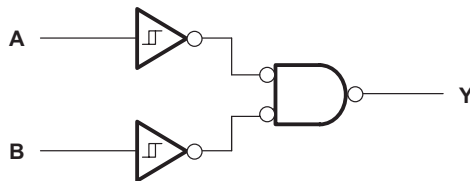

An IMPORTANT NOTICE at the end of this data sheet addresses availability, warranty, changes, use in safety-critical applications, intellectual property matters and other important disclaimers. PRODUCTION DATA.

On products compliant to MIL-PRF-38535, all parameters are tested unless otherwise noted. On all other products, production processing does not necessarily include testing of all parameters.

## Table of Contents

|  |          |  |           |
|--|----------|--|-----------|
| <b>1 Features</b> .....                          | <b>1</b> | 8.3 Feature Description .....                                    | <b>8</b>  |
| <b>2 Applications</b> .....                      | <b>1</b> | 8.4 Device Functional Modes .....                                | <b>8</b>  |
| <b>3 Description</b> .....                       | <b>1</b> | <b>9 Application and Implementation</b> .....                    | <b>9</b>  |
| <b>4 Revision History</b> .....                  | <b>2</b> | 9.1 Application Information .....                                | <b>9</b>  |
| <b>5 Pin Configuration and Functions</b> .....   | <b>3</b> | 9.2 Typical Application .....                                    | <b>9</b>  |
| <b>6 Specifications</b> .....                    | <b>4</b> | <b>10 Power Supply Recommendations</b> .....                     | <b>10</b> |
| 6.1 Absolute Maximum Ratings .....               | <b>4</b> | <b>11 Layout</b> .....   | <b>10</b> |
| 6.2 ESD Ratings .....                            | <b>4</b> | 11.1 Layout Guidelines .....                                     | <b>10</b> |
| 6.3 Recommended Operating Conditions .....       | <b>4</b> | 11.2 Layout Example .....  | <b>10</b> |
| 6.4 Thermal Information .....                    | <b>4</b> | <b>12 Device and Documentation Support</b> .....                 | <b>11</b> |
| 6.5 Electrical Characteristics .....             | <b>5</b> | 12.1 Documentation Support .....                                 | <b>11</b> |
| 6.6 Switching Characteristics .....              | <b>6</b> | 12.2 Related Links .....   | <b>11</b> |
| 6.7 Operating Characteristics .....              | <b>6</b> | 12.3 Receiving Notification of Documentation Updates .....       | <b>11</b> |
| 6.8 Typical Characteristics .....                | <b>6</b> | 12.4 Community Resources .....                                   | <b>11</b> |
| <b>7 Parameter Measurement Information</b> ..... | <b>7</b> | 12.5 Trademarks .....  | <b>11</b> |
| <b>8 Detailed Description</b> .....              | <b>8</b> | 12.6 Electrostatic Discharge Caution .....                       | <b>11</b> |
| 8.1 Overview .....                               | <b>8</b> | 12.7 Glossary .....  | <b>11</b> |
| 8.2 Functional Block Diagram .....               | <b>8</b> | <b>13 Mechanical, Packaging, and Orderable Information</b> ..... | <b>11</b> |

## 4 Revision History

NOTE: Page numbers for previous revisions may differ from page numbers in the current version.

| Changes from Revision F (November 2004) to Revision G  | Page     |
|--|----------|
| • Added <i>ESD Ratings</i> table, <i>Feature Description</i> section, <i>Device Functional Modes</i> , <i>Application and Implementation</i> section, <i>Power Supply Recommendations</i> section, <i>Layout</i> section, <i>Device and Documentation Support</i> section, and <i>Mechanical, Packaging, and Orderable Information</i> section. .... | <b>1</b> |
| • Removed Ordering Information table, see POA at the end of the data sheet. ....   | <b>1</b> |

## 5 Pin Configuration and Functions

D, DB, N, NS, J, W, or PW Package  
14-Pin SOIC, SSOP, PDIP, SO, or TSSOP  
Top View

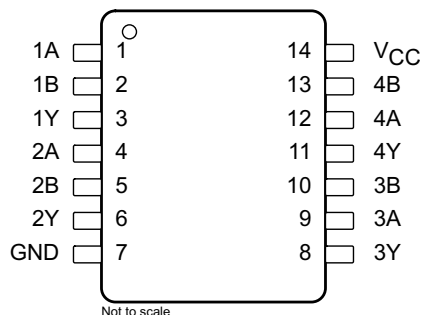

FK Package  
20-Pin LCCC  
Top View

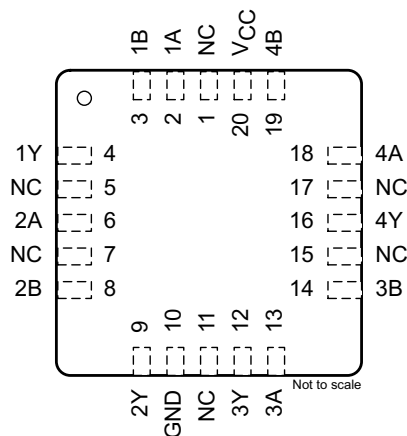

Pin Functions<sup>(1)</sup>

| NAME            | PIN                         |                     | I/O | DESCRIPTION   |
|-----------------|-----------------------------|---------------------|-----|---------------|
|                 | SOIC, SSOP, PDIP, SO, TSSOP | LCCC                |     |               |
| 1A              | 1                           | 2                   | I   | 1A Input      |
| 1B              | 2                           | 3                   | I   | 1B Input      |
| 1Y              | 3                           | 4                   | O   | 1Y Output     |
| 2A              | 4                           | 6                   | I   | 2A Input      |
| 2B              | 5                           | 8                   | I   | 2B Input      |
| 2Y              | 6                           | 9                   | O   | 2Y Output     |
| 3A              | 9                           | 13                  | I   | 3A Input      |
| 3B              | 10                          | 14                  | I   | 3B Input      |
| 3Y              | 8                           | 12                  | O   | 3Y Output     |
| 4A              | 12                          | 18                  | I   | 4A Input      |
| 4B              | 13                          | 19                  | I   | 4B Input      |
| 4Y              | 11                          | 16                  | O   | 4Y Output     |
| GND             | 7                           | 10                  | —   | Ground Pin    |
| NC              | —                           | 1, 5, 7, 11, 15, 17 | —   | No Connection |
| V <sub>CC</sub> | 14                          | 20                  | —   | Power Pin     |

(1) NC – no connection

## 6 Specifications

### 6.1 Absolute Maximum Ratings

over operating free-air temperature range (unless otherwise noted)<sup>(1)</sup>

|                  |   | MIN  | MAX | UNIT      |
|------------------|---|--|-----|-----------|
| V <sub>CC</sub>  | Supply voltage                                    | -0.5   | 7   | V         |
| I <sub>IK</sub>  | Input clamp current <sup>(2)</sup>                | V <sub>I</sub> < 0 or V <sub>I</sub> > V <sub>CC</sub> |     | ±20<br>mA |
| I <sub>OK</sub>  | Output clamp current <sup>(2)</sup>               | V <sub>O</sub> < 0 or V <sub>O</sub> > V <sub>CC</sub> |     | ±20<br>mA |
| I <sub>O</sub>   | Continuous output current                         | V <sub>O</sub> = 0 to V <sub>CC</sub>                  |     | ±25<br>mA |
|                  | Continuous current through V <sub>CC</sub> or GND |  | ±50 | mA        |
| T <sub>J</sub>   | Junction temperature                              |  | 150 | °C        |
| T <sub>stg</sub> | Storage temperature                               | -65  | 150 | °C        |

- (1) Stresses beyond those listed under *Absolute Maximum Ratings* may cause permanent damage to the device. These are stress ratings only, and functional operation of the device at these or any other conditions beyond those indicated under *Recommended Operating Conditions* is not implied. Exposure to absolute-maximum-rated conditions for extended periods may affect device reliability.
- (2) The input and output voltage ratings may be exceeded if the input and output current ratings are observed.

### 6.2 ESD Ratings

|                    |                         | VALUE  | UNIT  |
|--------------------|-------------------------|--|-------|
| V <sub>(ESD)</sub> | Electrostatic discharge | Human-body model (HBM), per ANSI/ESDA/JEDEC JS-001 <sup>(1)</sup>              | ±2000 |
|                    |                         | Charged-device model (CDM), per JEDEC specification JESD22-C101 <sup>(2)</sup> | ±1000 |

- (1) JEDEC document JEP155 states that 500-V HBM allows safe manufacturing with a standard ESD control process.
- (2) JEDEC document JEP157 states that 250-V CDM allows safe manufacturing with a standard ESD control process.

### 6.3 Recommended Operating Conditions

See <sup>(1)</sup>

|                 |                                | MIN       | NOM | MAX             | UNIT |
|-----------------|--------------------------------|-----------|-----|-----------------|------|
| V <sub>CC</sub> | Supply voltage                 | 2         | 5   | 6               | V    |
| V <sub>I</sub>  | Input voltage                  | 0         |     | V <sub>CC</sub> | V    |
| V <sub>O</sub>  | Output voltage                 | 0         |     | V <sub>CC</sub> | V    |
| T <sub>A</sub>  | Operating free-air temperature | SN54HC132 |     | 125             | °C   |
|                 |                                | SN74HC132 | -40 | 85              |      |

- (1) All unused inputs of the device must be held at V<sub>CC</sub> or GND to ensure proper device operation. Refer to the TI application report, [Implications of Slow or Floating CMOS Inputs](#).

### 6.4 Thermal Information

| THERMAL METRIC <sup>(1)</sup> | SN74HC132   |           |          |         |            | UNIT  |      |
|-------------------------------|---|-----------|----------|---------|------------|-------|------|
|                               | D (SOIC)  | DB (SSOP) | N (PDIP) | NS (SO) | PW (TSSOP) |       |      |
|                               | 14 PINS   | 14 PINS   | 14 PINS  | 14 PINS | 14 PINS    |       |      |
| R <sub>θJA</sub>              | Junction-to-ambient thermal resistance <sup>(2)</sup> | 84.3      | 99.1     | 50.9    | 84.3       | 113.3 | °C/W |
| R <sub>θJC(top)</sub>         | Junction-to-case (top) thermal resistance             | 44.8      | 51.3     | 38.2    | 42.2       | 42.8  | °C/W |
| R <sub>θJB</sub>              | Junction-to-board thermal resistance                  | 38.5      | 46.3     | 30.8    | 43.0       | 54.8  | °C/W |
| ψ <sub>JT</sub>               | Junction-to-top characterization parameter            | 13.9      | 17.7     | 23.1    | 13.5       | 4.0   | °C/W |
| ψ <sub>JB</sub>               | Junction-to-board characterization parameter          | 38.2      | 45.8     | 30.7    | 42.7       | 54.3  | °C/W |

- (1) For more information about traditional and new thermal metrics, see the application report, [Semiconductor and IC Package Thermal Metrics](#).
- (2) The package thermal impedance is calculated in accordance with JESD 51-7.

## 6.5 Electrical Characteristics

over recommended operating free-air temperature range (unless otherwise noted)

| PARAMETER                         | TEST CONDITIONS   |                           | V <sub>CC</sub>       | MIN  | TYP   | MAX  | UNIT  |      |  |
|-----------------------------------|---|---------------------------|-----------------------|------|-------|------|-------|------|--|
| V <sub>T+</sub>                   |   |                           | 2 V                   | 0.7  | 1.2   | 1.5  | V     |      |  |
|                                   |   |                           | 4.5 V                 | 1.55 | 2.5   | 3.15 |       |      |  |
|                                   |   |                           | 6 V                   | 2.1  | 3.3   | 4.2  |       |      |  |
| V <sub>T-</sub>                   |   |                           | 2 V                   | 0.3  | 0.6   | 1    | V     |      |  |
|                                   |   |                           | 4.5 V                 | 0.9  | 1.6   | 2.45 |       |      |  |
|                                   |   |                           | 6 V                   | 1.2  | 2     | 3.2  |       |      |  |
| V <sub>T+</sub> – V <sub>T-</sub> |   |                           | 2 V                   | 0.2  | 0.6   | 1.2  | V     |      |  |
|                                   |   |                           | 4.5 V                 | 0.4  | 0.9   | 2.1  |       |      |  |
|                                   |   |                           | 6 V                   | 0.5  | 1.3   | 2.5  |       |      |  |
| V <sub>OH</sub>                   | V <sub>I</sub> = V <sub>IH</sub> or V <sub>IL</sub>       | I <sub>OH</sub> = –20 μA  | 2 V                   | 1.9  | 1.998 |      | V     |      |  |
|                                   |   |                           | 4.5 V                 | 4.4  | 4.499 |      |       |      |  |
|                                   |   |                           | 6 V                   | 5.9  | 5.999 |      |       |      |  |
|                                   |   | I <sub>OH</sub> = –4 mA   | T <sub>A</sub> = 25°C |      | 4.5 V | 3.98 |       | 4.3  |  |
|                                   |   |                           | SN54HC132             |      |       |      |       | 3.7  |  |
|                                   |   |                           | SN74HC132             |      |       |      |       | 3.84 |  |
|                                   |   | I <sub>OH</sub> = –5.2 mA | T <sub>A</sub> = 25°C |      | 6 V   | 5.48 |       | 5.8  |  |
|                                   |   |                           | SN54HC132             |      |       |      |       | 5.2  |  |
|                                   |   |                           | SN74HC132             |      |       |      |       | 5.34 |  |
| V <sub>OL</sub>                   | V <sub>I</sub> = V <sub>IH</sub> or V <sub>IL</sub>       | I <sub>OL</sub> = 20 μA   | 2 V                   |      | 0.002 | 0.1  | V     |      |  |
|                                   |   |                           | 4.5 V                 |      | 0.001 | 0.1  |       |      |  |
|                                   |   |                           | 6 V                   |      | 0.001 | 0.1  |       |      |  |
|                                   |   | I <sub>OL</sub> = 4 mA    | T <sub>A</sub> = 25°C |      | 4.5 V | 0.17 |       | 0.26 |  |
|                                   |   |                           | SN54HC132             |      |       |      |       | 0.4  |  |
|                                   |   |                           | SN74HC132             |      |       |      |       | 0.33 |  |
|                                   |   | I <sub>OL</sub> = 5.2 mA  | T <sub>A</sub> = 25°C |      | 6 V   | 0.15 |       | 0.26 |  |
|                                   |   |                           | SN54HC132             |      |       |      |       | 0.4  |  |
|                                   |   |                           | SN74HC132             |      |       |      |       | 0.33 |  |
| I <sub>I</sub>                    | V <sub>I</sub> = V <sub>CC</sub> or 0                     | T <sub>A</sub> = 25°C     |                       | 6 V  | ±0.1  |      | ±100  |      |  |
|                                   |   | SN54HC132,<br>SN74HC132   |                       |      |       |      | ±1000 |      |  |
| I <sub>CC</sub>                   | V <sub>I</sub> = V <sub>CC</sub> or 0, I <sub>O</sub> = 0 | T <sub>A</sub> = 25°C     |                       | 6 V  |       |      | 2     |      |  |
|                                   |   | SN54HC132                 |                       |      |       |      | 40    |      |  |
|                                   |   | SN74HC132                 |                       |      |       |      | 20    |      |  |
| C <sub>i</sub>                    |   |                           | 2 V to 6 V            | 3    |       | 10   | pF    |      |  |

### 6.6 Switching Characteristics

over recommended operating free-air temperature range,  $C_L = 50\text{ pF}$  (unless otherwise noted) (see Figure 3)

| PARAMETER | FROM (INPUT) | TO (OUTPUT) | $V_{CC}$ | $T_A$                    | MIN | TYP | MAX | UNIT |
|-----------|--------------|-------------|----------|--------------------------|-----|-----|-----|------|
| $t_{pd}$  | A or B       | Y           | 2 V      | $T_A = 25^\circ\text{C}$ |     | 60  | 120 | ns   |
|           |              |             |          | SN54HC132                |     |     | 186 |      |
|           |              |             |          | SN74HC132                |     |     | 156 |      |
|           |              |             | 4.5 V    | $T_A = 25^\circ\text{C}$ |     | 18  | 25  |      |
|           |              |             |          | SN54HC132                |     |     | 37  |      |
|           |              |             |          | SN74HC132                |     |     | 31  |      |
|           |              |             | 6 V      | $T_A = 25^\circ\text{C}$ |     | 14  | 21  |      |
|           |              |             |          | SN54HC132                |     |     | 32  |      |
|           |              |             |          | SN74HC132                |     |     | 27  |      |
| $t_t$     | Any          | Any         | 2 V      | $T_A = 25^\circ\text{C}$ |     | 28  | 75  | ns   |
|           |              |             |          | SN54HC132                |     |     | 110 |      |
|           |              |             |          | SN74HC132                |     |     | 95  |      |
|           |              |             | 4.5 V    | $T_A = 25^\circ\text{C}$ |     | 8   | 15  |      |
|           |              |             |          | SN54HC132                |     |     | 22  |      |
|           |              |             |          | SN74HC132                |     |     | 19  |      |
|           |              |             | 6 V      | $T_A = 25^\circ\text{C}$ |     | 6   | 13  |      |
|           |              |             |          | SN54HC132                |     |     | 19  |      |
|           |              |             |          | SN74HC132                |     |     | 16  |      |

### 6.7 Operating Characteristics

$T_A = 25^\circ\text{C}$

| PARAMETER                                       | TEST CONDITIONS | TYP | UNIT |
|---|-----------------|-----|------|
| $C_{pd}$ Power dissipation capacitance per gate | No load         | 20  | pF   |

### 6.8 Typical Characteristics

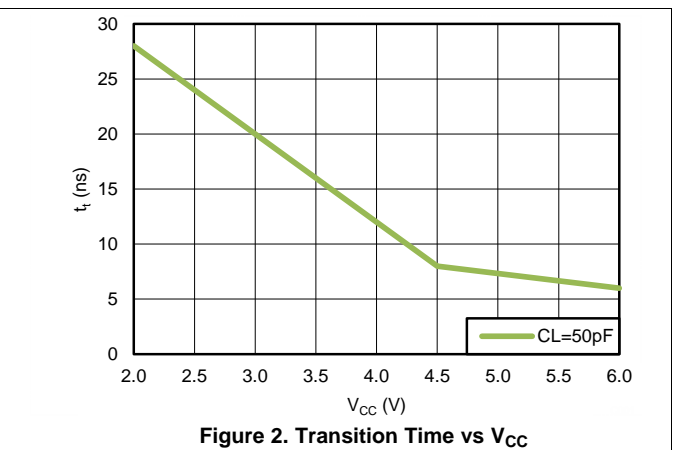
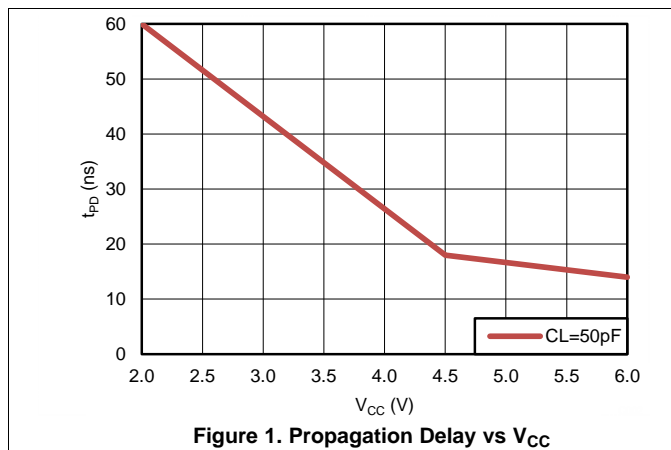

## 7 Parameter Measurement Information

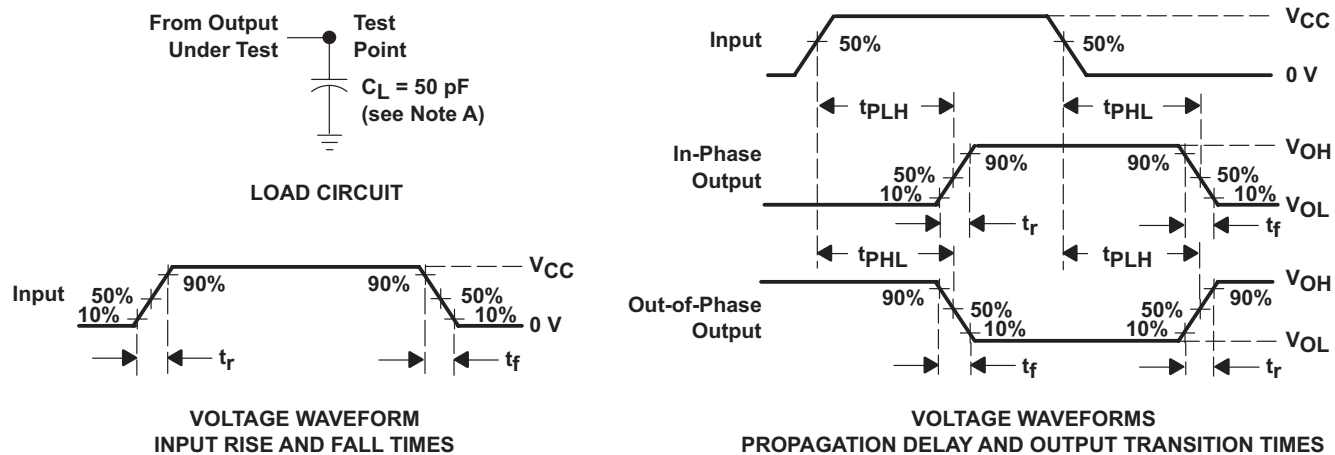

- NOTES: A.  $C_L$  includes probe and test-fixture capacitance.  
 B. Phase relationships between waveforms were chosen arbitrarily. All input pulses are supplied by generators having the following characteristics:  $PRR \leq 1$  MHz,  $Z_O = 50 \Omega$ ,  $t_r = 6$  ns,  $t_f = 6$  ns.  
 C. The outputs are measured one at a time, with one input transition per measurement.  
 D.  $t_{PLH}$  and  $t_{PHL}$  are the same as  $t_{pd}$ .

Figure 3. Load Circuit and Voltage Waveforms

## 8 Detailed Description

### 8.1 Overview

The SNx4HC132 is a quadruple 2-input positive-NAND gate with low drive that produces slow rise and fall times. This reduces ringing on the output signal.

Each circuit functions as a NAND gate, but because of the Schmitt action, it has different input threshold levels for positive- and negative-going signals.

These circuits are temperature compensated and can be triggered from the slowest of input ramps and still give clean, jitter-free output signals.

### 8.2 Functional Block Diagram

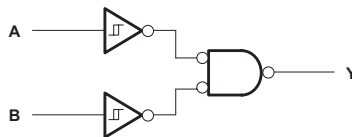

Figure 4. Logic Diagram (Positive Logic)

### 8.3 Feature Description

The SNx4HC132 has a wide operating range of 2 V to 6 V. The SNx4HC132 also has a low power consumption where the maximum ICC is 20  $\mu$ A.

### 8.4 Device Functional Modes

Table 1 lists the functional modes of the SNx4HC132.

Table 1. Function Table (Each Gate)

| INPUTS |   | OUTPUT<br>Y |
|--------|---|-------------|
| A      | B |             |
| H      | H | L           |
| L      | X | H           |
| X      | L | H           |

## 9 Application and Implementation

### NOTE

Information in the following applications sections is not part of the TI component specification, and TI does not warrant its accuracy or completeness. TI's customers are responsible for determining suitability of components for their purposes. Customers should validate and test their design implementation to confirm system functionality.

### 9.1 Application Information

The SN74HC132 is a low-drive CMOS device that can be used for a multitude of bus interface type applications where output ringing is a concern. The low drive and slow edge rates minimize overshoot and undershoot on the outputs. The inputs can accept voltages to  $V_{CC}$ . The current consumption of the device is low with maximum  $20\text{-}\mu\text{A } I_{CC}$ .

### 9.2 Typical Application

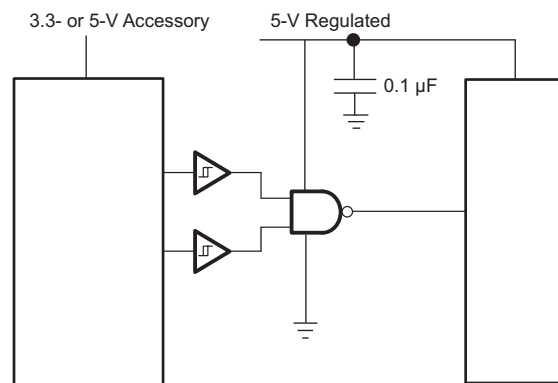

Figure 5. Typical Application Diagram

#### 9.2.1 Design Requirements

This device uses CMOS technology and has balanced output drive. Take care to avoid bus contention because it can drive currents that would exceed maximum limits. The high drive also creates fast edges into light loads, so consider routing and load conditions to prevent ringing.

#### 9.2.2 Detailed Design Procedure

1. Recommended Input Conditions:
  - For rise time and fall time specifications, see  $\Delta t/\Delta V$  in the [Recommended Operating Conditions](#) table.
  - For specified high and low levels, see  $V_{IH}$  and  $V_{IL}$  in the [Recommended Operating Conditions](#) table.
2. Recommend Output Conditions:
  - Load currents should not exceed 25 mA per output and 50 mA total for the part.
  - Outputs must not be pulled above  $V_{CC}$ .

## Typical Application (continued)

### 9.2.3 Application Curve

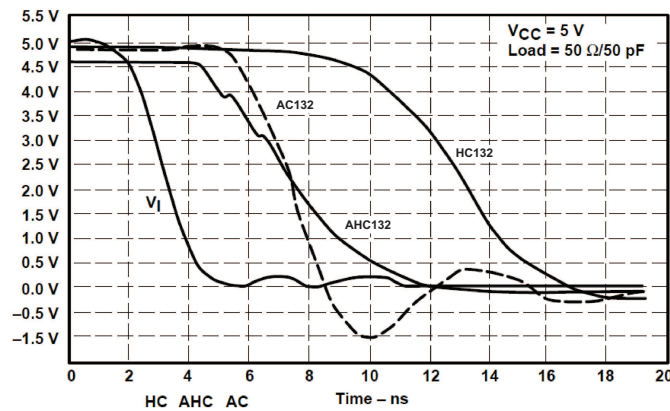

Figure 6. Switching Characteristics Comparison

## 10 Power Supply Recommendations

The power supply can be any voltage between the minimum and maximum supply-voltage rating located in the [Recommended Operating Conditions](#) table.

Each  $V_{CC}$  pin must have a good bypass capacitor to prevent power disturbance. For devices with a single supply, 0.1  $\mu\text{F}$  is recommended. If there are multiple  $V_{CC}$  pins then a 0.01  $\mu\text{F}$  or a 0.022  $\mu\text{F}$  is recommended for each power pin. It is acceptable to parallel multiple bypass caps to reject different frequencies of noise. A 0.1  $\mu\text{F}$  and a 1  $\mu\text{F}$  are commonly used in parallel. The bypass capacitor must be installed as close to the power pin as possible for best results.

## 11 Layout

### 11.1 Layout Guidelines

When using multiple bit logic devices, inputs must not float. In many cases, functions or parts of functions of digital logic devices are unused. Some examples are when only two inputs of a triple-input AND gate are used, or when only 3 of the 4-buffer gates are used. Such input pins must not be left unconnected because the undefined voltages at the outside connections result in undefined operational states.

Specified in [Figure 7](#) are rules that must be observed under all circumstances. All unused inputs of digital logic devices must be connected to a high or low bias to prevent them from floating. The logic level that should be applied to any particular unused input depends on the function of the device. Generally they are tied to GND or  $V_{CC}$ , whichever makes more sense or is more convenient. It is acceptable to float outputs unless the part is a transceiver. If the transceiver has an output enable pin, it disables the outputs section of the part when asserted. This does not disable the input section of the I/Os so they also cannot float when disabled.

### 11.2 Layout Example

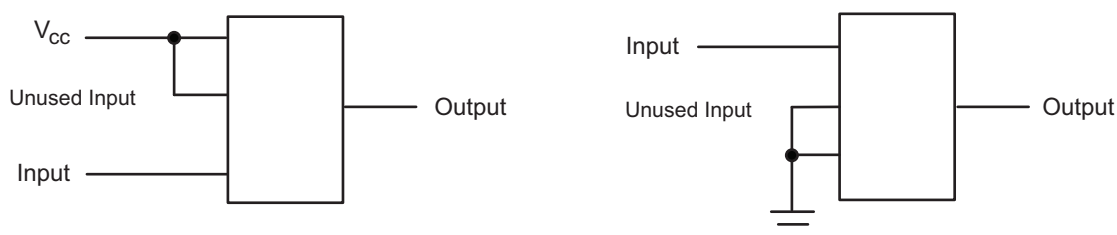

Figure 7. Layout Diagram

## 12 Device and Documentation Support

### 12.1 Documentation Support

#### 12.1.1 Related Documentation

For related documentation, see the following:

[Implications of Slow or Floating CMOS Inputs](#) (SCBA004)

### 12.2 Related Links

The table below lists quick access links. Categories include technical documents, support and community resources, tools and software, and quick access to sample or buy.

**Table 2. Related Links**

| PARTS     | PRODUCT FOLDER             | SAMPLE & BUY               | TECHNICAL DOCUMENTS        | TOOLS & SOFTWARE           | SUPPORT & COMMUNITY        |
|-----------|----------------------------|----------------------------|----------------------------|----------------------------|----------------------------|
| SN54HC132 | <a href="#">Click here</a> | <a href="#">Click here</a> | <a href="#">Click here</a> | <a href="#">Click here</a> | <a href="#">Click here</a> |
| SN74HC132 | <a href="#">Click here</a> | <a href="#">Click here</a> | <a href="#">Click here</a> | <a href="#">Click here</a> | <a href="#">Click here</a> |

### 12.3 Receiving Notification of Documentation Updates

To receive notification of documentation updates, navigate to the device product folder on ti.com. In the upper right corner, click on *Alert me* to register and receive a weekly digest of any product information that has changed. For change details, review the revision history included in any revised document.

### 12.4 Community Resources

The following links connect to TI community resources. Linked contents are provided "AS IS" by the respective contributors. They do not constitute TI specifications and do not necessarily reflect TI's views; see TI's [Terms of Use](#).

**TI E2E™ Online Community** *TI's Engineer-to-Engineer (E2E) Community*. Created to foster collaboration among engineers. At e2e.ti.com, you can ask questions, share knowledge, explore ideas and help solve problems with fellow engineers.

**Design Support** *TI's Design Support* Quickly find helpful E2E forums along with design support tools and contact information for technical support.

### 12.5 Trademarks

E2E is a trademark of Texas Instruments.

All other trademarks are the property of their respective owners.

### 12.6 Electrostatic Discharge Caution



This integrated circuit can be damaged by ESD. Texas Instruments recommends that all integrated circuits be handled with appropriate precautions. Failure to observe proper handling and installation procedures can cause damage.

ESD damage can range from subtle performance degradation to complete device failure. Precision integrated circuits may be more susceptible to damage because very small parametric changes could cause the device not to meet its published specifications.

### 12.7 Glossary

[SLYZ022](#) — *TI Glossary*.

This glossary lists and explains terms, acronyms, and definitions.

## 13 Mechanical, Packaging, and Orderable Information

The following pages include mechanical, packaging, and orderable information. This information is the most current data available for the designated devices. This data is subject to change without notice and revision of this document. For browser-based versions of this data sheet, refer to the left-hand navigation.

**PACKAGING INFORMATION**

| Orderable Device | Status<br>(1) | Package Type | Package<br>Drawing | Pins | Package<br>Qty | Eco Plan<br>(2)            | Lead/Ball Finish<br>(6) | MSL Peak Temp<br>(3) | Op Temp (°C) | Device Marking<br>(4/5)                | Samples                 |
|------------------|---------------|--------------|--------------------|------|----------------|----------------------------|-------------------------|----------------------|--------------|--|-------------------------|
| 5962-89845022A   | ACTIVE        | LCCC         | FK                 | 20   | 1              | TBD                        | POST-PLATE              | N / A for Pkg Type   | -55 to 125   | 5962-<br>89845022A<br>SNJ54HC<br>132FK | <a href="#">Samples</a> |
| 5962-8984502CA   | ACTIVE        | CDIP         | J                  | 14   | 1              | TBD                        | A42                     | N / A for Pkg Type   | -55 to 125   | 5962-8984502CA<br>SNJ54HC132J          | <a href="#">Samples</a> |
| 5962-8984502DA   | ACTIVE        | CFP          | W                  | 14   | 1              | TBD                        | A42                     | N / A for Pkg Type   | -55 to 125   | 5962-8984502DA<br>SNJ54HC132W          | <a href="#">Samples</a> |
| 5962-8984502VCA  | ACTIVE        | CDIP         | J                  | 14   | 1              | TBD                        | A42                     | N / A for Pkg Type   | -55 to 125   | 5962-8984502VC<br>A<br>SNV54HC132J     | <a href="#">Samples</a> |
| 5962-8984502VDA  | ACTIVE        | CFP          | W                  | 14   | 1              | TBD                        | A42                     | N / A for Pkg Type   | -55 to 125   | 5962-8984502VD<br>A<br>SNV54HC132W     | <a href="#">Samples</a> |
| SN54HC132J       | ACTIVE        | CDIP         | J                  | 14   | 1              | TBD                        | A42                     | N / A for Pkg Type   | -55 to 125   | SN54HC132J                             | <a href="#">Samples</a> |
| SN74HC132D       | ACTIVE        | SOIC         | D                  | 14   | 50             | Green (RoHS<br>& no Sb/Br) | CU NIPDAU               | Level-1-260C-UNLIM   | -40 to 85    | HC132                                  | <a href="#">Samples</a> |
| SN74HC132DBR     | ACTIVE        | SSOP         | DB                 | 14   | 2000           | Green (RoHS<br>& no Sb/Br) | CU NIPDAU               | Level-1-260C-UNLIM   | -40 to 85    | HC132                                  | <a href="#">Samples</a> |
| SN74HC132DBRG4   | ACTIVE        | SSOP         | DB                 | 14   | 2000           | Green (RoHS<br>& no Sb/Br) | CU NIPDAU               | Level-1-260C-UNLIM   | -40 to 85    | HC132                                  | <a href="#">Samples</a> |
| SN74HC132DE4     | ACTIVE        | SOIC         | D                  | 14   | 50             | Green (RoHS<br>& no Sb/Br) | CU NIPDAU               | Level-1-260C-UNLIM   | -40 to 85    | HC132                                  | <a href="#">Samples</a> |
| SN74HC132DR      | ACTIVE        | SOIC         | D                  | 14   | 2500           | Green (RoHS<br>& no Sb/Br) | CU NIPDAU               | Level-1-260C-UNLIM   | -40 to 85    | HC132                                  | <a href="#">Samples</a> |
| SN74HC132DRE4    | ACTIVE        | SOIC         | D                  | 14   | 2500           | Green (RoHS<br>& no Sb/Br) | CU NIPDAU               | Level-1-260C-UNLIM   | -40 to 85    | HC132                                  | <a href="#">Samples</a> |
| SN74HC132DRG4    | ACTIVE        | SOIC         | D                  | 14   | 2500           | Green (RoHS<br>& no Sb/Br) | CU NIPDAU               | Level-1-260C-UNLIM   | -40 to 85    | HC132                                  | <a href="#">Samples</a> |
| SN74HC132DT      | ACTIVE        | SOIC         | D                  | 14   | 250            | Green (RoHS<br>& no Sb/Br) | CU NIPDAU               | Level-1-260C-UNLIM   | -40 to 85    | HC132                                  | <a href="#">Samples</a> |
| SN74HC132DTE4    | ACTIVE        | SOIC         | D                  | 14   | 250            | Green (RoHS<br>& no Sb/Br) | CU NIPDAU               | Level-1-260C-UNLIM   | -40 to 85    | HC132                                  | <a href="#">Samples</a> |

| Orderable Device | Status<br>(1) | Package Type | Package Drawing | Pins | Package Qty | Eco Plan<br>(2)         | Lead/Ball Finish<br>(6) | MSL Peak Temp<br>(3) | Op Temp (°C) | Device Marking<br>(4/5)            | Samples                 |
|------------------|---------------|--------------|-----------------|------|-------------|-------------------------|-------------------------|----------------------|--------------|------------------------------------|-------------------------|
| SN74HC132N       | ACTIVE        | PDIP         | N               | 14   | 25          | Green (RoHS & no Sb/Br) | CU NIPDAU               | N / A for Pkg Type   | -40 to 85    | SN74HC132N                         | <a href="#">Samples</a> |
| SN74HC132NE4     | ACTIVE        | PDIP         | N               | 14   | 25          | Green (RoHS & no Sb/Br) | CU NIPDAU               | N / A for Pkg Type   | -40 to 85    | SN74HC132N                         | <a href="#">Samples</a> |
| SN74HC132NSR     | ACTIVE        | SO           | NS              | 14   | 2000        | Green (RoHS & no Sb/Br) | CU NIPDAU               | Level-1-260C-UNLIM   | -40 to 85    | HC132                              | <a href="#">Samples</a> |
| SN74HC132NSRG4   | ACTIVE        | SO           | NS              | 14   | 2000        | Green (RoHS & no Sb/Br) | CU NIPDAU               | Level-1-260C-UNLIM   | -40 to 85    | HC132                              | <a href="#">Samples</a> |
| SN74HC132PW      | ACTIVE        | TSSOP        | PW              | 14   | 90          | Green (RoHS & no Sb/Br) | CU NIPDAU               | Level-1-260C-UNLIM   | -40 to 85    | HC132                              | <a href="#">Samples</a> |
| SN74HC132PWR     | ACTIVE        | TSSOP        | PW              | 14   | 2000        | Green (RoHS & no Sb/Br) | CU NIPDAU               | Level-1-260C-UNLIM   | -40 to 85    | HC132                              | <a href="#">Samples</a> |
| SN74HC132PWRG4   | ACTIVE        | TSSOP        | PW              | 14   | 2000        | Green (RoHS & no Sb/Br) | CU NIPDAU               | Level-1-260C-UNLIM   | -40 to 85    | HC132                              | <a href="#">Samples</a> |
| SN74HC132PWT     | ACTIVE        | TSSOP        | PW              | 14   | 250         | Green (RoHS & no Sb/Br) | CU NIPDAU               | Level-1-260C-UNLIM   | -40 to 85    | HC132                              | <a href="#">Samples</a> |
| SNJ54HC132FK     | ACTIVE        | LCCC         | FK              | 20   | 1           | TBD                     | POST-PLATE              | N / A for Pkg Type   | -55 to 125   | 5962-89845022A<br>SNJ54HC<br>132FK | <a href="#">Samples</a> |
| SNJ54HC132J      | ACTIVE        | CDIP         | J               | 14   | 1           | TBD                     | A42                     | N / A for Pkg Type   | -55 to 125   | 5962-8984502CA<br>SNJ54HC132J      | <a href="#">Samples</a> |
| SNJ54HC132W      | ACTIVE        | CFP          | W               | 14   | 1           | TBD                     | A42                     | N / A for Pkg Type   | -55 to 125   | 5962-8984502DA<br>SNJ54HC132W      | <a href="#">Samples</a> |

(1) The marketing status values are defined as follows:

**ACTIVE:** Product device recommended for new designs.

**LIFEBUY:** TI has announced that the device will be discontinued, and a lifetime-buy period is in effect.

**NRND:** Not recommended for new designs. Device is in production to support existing customers, but TI does not recommend using this part in a new design.

**PREVIEW:** Device has been announced but is not in production. Samples may or may not be available.

**OBSELETE:** TI has discontinued the production of the device.

(2) **RoHS:** TI defines "RoHS" to mean semiconductor products that are compliant with the current EU RoHS requirements for all 10 RoHS substances, including the requirement that RoHS substance do not exceed 0.1% by weight in homogeneous materials. Where designed to be soldered at high temperatures, "RoHS" products are suitable for use in specified lead-free processes. TI may reference these types of products as "Pb-Free".

**RoHS Exempt:** TI defines "RoHS Exempt" to mean products that contain lead but are compliant with EU RoHS pursuant to a specific EU RoHS exemption.

**Green:** TI defines "Green" to mean the content of Chlorine (Cl) and Bromine (Br) based flame retardants meet JS709B low halogen requirements of <=1000ppm threshold. Antimony trioxide based flame retardants must also meet the <=1000ppm threshold requirement.

(3) MSL, Peak Temp. - The Moisture Sensitivity Level rating according to the JEDEC industry standard classifications, and peak solder temperature.

(4) There may be additional marking, which relates to the logo, the lot trace code information, or the environmental category on the device.

(5) Multiple Device Markings will be inside parentheses. Only one Device Marking contained in parentheses and separated by a "~" will appear on a device. If a line is indented then it is a continuation of the previous line and the two combined represent the entire Device Marking for that device.

(6) Lead/Ball Finish - Orderable Devices may have multiple material finish options. Finish options are separated by a vertical ruled line. Lead/Ball Finish values may wrap to two lines if the finish value exceeds the maximum column width.

**Important Information and Disclaimer:**The information provided on this page represents TI's knowledge and belief as of the date that it is provided. TI bases its knowledge and belief on information provided by third parties, and makes no representation or warranty as to the accuracy of such information. Efforts are underway to better integrate information from third parties. TI has taken and continues to take reasonable steps to provide representative and accurate information but may not have conducted destructive testing or chemical analysis on incoming materials and chemicals. TI and TI suppliers consider certain information to be proprietary, and thus CAS numbers and other limited information may not be available for release.

In no event shall TI's liability arising out of such information exceed the total purchase price of the TI part(s) at issue in this document sold by TI to Customer on an annual basis.

**OTHER QUALIFIED VERSIONS OF SN54HC132, SN54HC132-SP, SN74HC132 :**

- Catalog: [SN74HC132](#), [SN54HC132](#)
  
- Automotive: [SN74HC132-Q1](#), [SN74HC132-Q1](#)
  
- Military: [SN54HC132](#)
  
- Space: [SN54HC132-SP](#)

NOTE: Qualified Version Definitions:

- Catalog - TI's standard catalog product
  
- Automotive - Q100 devices qualified for high-reliability automotive applications targeting zero defects
  
- Military - QML certified for Military and Defense Applications
  
- Space - Radiation tolerant, ceramic packaging and qualified for use in Space-based application

## TAPE AND REEL INFORMATION



### QUADRANT ASSIGNMENTS FOR PIN 1 ORIENTATION IN TAPE



\*All dimensions are nominal

| Device       | Package Type | Package Drawing | Pins | SPQ  | Reel Diameter (mm) | Reel Width W1 (mm) | A0 (mm) | B0 (mm) | K0 (mm) | P1 (mm) | W (mm) | Pin1 Quadrant |
|--------------|--------------|-----------------|------|------|--------------------|--------------------|---------|---------|---------|---------|--------|---------------|
| SN74HC132DR  | SOIC         | D               | 14   | 2500 | 330.0              | 16.4               | 6.5     | 9.0     | 2.1     | 8.0     | 16.0   | Q1            |
| SN74HC132DR  | SOIC         | D               | 14   | 2500 | 330.0              | 16.4               | 6.5     | 9.0     | 2.1     | 8.0     | 16.0   | Q1            |
| SN74HC132DT  | SOIC         | D               | 14   | 250  | 330.0              | 16.4               | 6.5     | 9.0     | 2.1     | 8.0     | 16.0   | Q1            |
| SN74HC132PWR | TSSOP        | PW              | 14   | 2000 | 330.0              | 12.4               | 6.9     | 5.6     | 1.6     | 8.0     | 12.0   | Q1            |
| SN74HC132PWT | TSSOP        | PW              | 14   | 250  | 330.0              | 12.4               | 6.9     | 5.6     | 1.6     | 8.0     | 12.0   | Q1            |

**TAPE AND REEL BOX DIMENSIONS**

\*All dimensions are nominal

| Device       | Package Type | Package Drawing | Pins | SPQ  | Length (mm) | Width (mm) | Height (mm) |
|--------------|--------------|-----------------|------|------|-------------|------------|-------------|
| SN74HC132DR  | SOIC         | D               | 14   | 2500 | 367.0       | 367.0      | 38.0        |
| SN74HC132DR  | SOIC         | D               | 14   | 2500 | 333.2       | 345.9      | 28.6        |
| SN74HC132DT  | SOIC         | D               | 14   | 250  | 210.0       | 185.0      | 35.0        |
| SN74HC132PWR | TSSOP        | PW              | 14   | 2000 | 367.0       | 367.0      | 35.0        |
| SN74HC132PWT | TSSOP        | PW              | 14   | 250  | 367.0       | 367.0      | 35.0        |

FK (S-CQCC-N\*\*)

LEADLESS CERAMIC CHIP CARRIER

28 TERMINAL SHOWN



| NO. OF TERMINALS ** | A                |                  | B                |                  |
|---------------------|------------------|------------------|------------------|------------------|
|                     | MIN              | MAX              | MIN              | MAX              |
| 20                  | 0.342<br>(8,69)  | 0.358<br>(9,09)  | 0.307<br>(7,80)  | 0.358<br>(9,09)  |
| 28                  | 0.442<br>(11,23) | 0.458<br>(11,63) | 0.406<br>(10,31) | 0.458<br>(11,63) |
| 44                  | 0.640<br>(16,26) | 0.660<br>(16,76) | 0.495<br>(12,58) | 0.560<br>(14,22) |
| 52                  | 0.740<br>(18,78) | 0.761<br>(19,32) | 0.495<br>(12,58) | 0.560<br>(14,22) |
| 68                  | 0.938<br>(23,83) | 0.962<br>(24,43) | 0.850<br>(21,6)  | 0.858<br>(21,8)  |
| 84                  | 1.141<br>(28,99) | 1.165<br>(29,59) | 1.047<br>(26,6)  | 1.063<br>(27,0)  |



4040140/D 01/11

- NOTES:
- All linear dimensions are in inches (millimeters).
  - This drawing is subject to change without notice.
  - This package can be hermetically sealed with a metal lid.
  - Falls within JEDEC MS-004

## MECHANICAL DATA

**NS (R-PDSO-G\*\*)**

**PLASTIC SMALL-OUTLINE PACKAGE**

**14-PINS SHOWN**



- NOTES:
- A. All linear dimensions are in millimeters.
  - B. This drawing is subject to change without notice.
  - C. Body dimensions do not include mold flash or protrusion, not to exceed 0,15.

W (R-GDFP-F14)

CERAMIC DUAL FLATPACK



- NOTES:
- A. All linear dimensions are in inches (millimeters).
  - B. This drawing is subject to change without notice.
  - C. This package can be hermetically sealed with a ceramic lid using glass frit.
  - D. Index point is provided on cap for terminal identification only.
  - E. Falls within MIL STD 1835 GDFP1-F14

J 14

**GENERIC PACKAGE VIEW**  
**CDIP - 5.08 mm max height**  
CERAMIC DUAL IN LINE PACKAGE

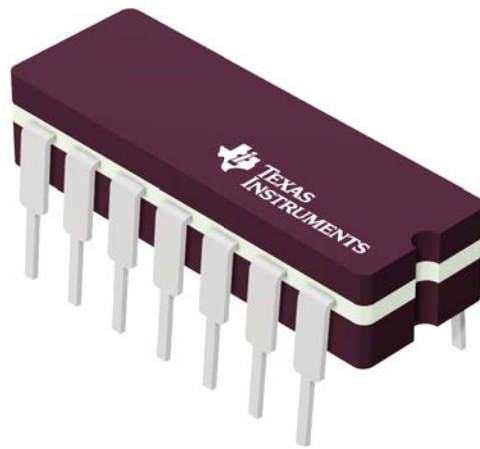

Images above are just a representation of the package family, actual package may vary.  
Refer to the product data sheet for package details.

4040083-5/G

J0014A



# PACKAGE OUTLINE

CDIP - 5.08 mm max height

CERAMIC DUAL IN LINE PACKAGE



4214771/A 05/2017

NOTES:

1. All controlling linear dimensions are in inches. Dimensions in brackets are in millimeters. Any dimension in brackets or parenthesis are for reference only. Dimensioning and tolerancing per ASME Y14.5M.
2. This drawing is subject to change without notice.
3. This package is hermetically sealed with a ceramic lid using glass frit.
4. Index point is provided on cap for terminal identification only and on press ceramic glass frit seal only.
5. Falls within MIL-STD-1835 and GDIP1-T14.

# EXAMPLE BOARD LAYOUT

J0014A

CDIP - 5.08 mm max height

CERAMIC DUAL IN LINE PACKAGE



LAND PATTERN EXAMPLE  
NON-SOLDER MASK DEFINED  
SCALE: 5X



4214771/A 05/2017

D (R-PDSO-G14)

PLASTIC SMALL OUTLINE



- NOTES:
- A. All linear dimensions are in inches (millimeters).
  - B. This drawing is subject to change without notice.
  -  Body length does not include mold flash, protrusions, or gate burrs. Mold flash, protrusions, or gate burrs shall not exceed 0.006 (0,15) each side.
  -  Body width does not include interlead flash. Interlead flash shall not exceed 0.017 (0,43) each side.
  - E. Reference JEDEC MS-012 variation AB.

D (R-PDSO-G14)

PLASTIC SMALL OUTLINE



- NOTES:
- A. All linear dimensions are in millimeters.
  - B. This drawing is subject to change without notice.
  - C. Publication IPC-7351 is recommended for alternate designs.
  - D. Laser cutting apertures with trapezoidal walls and also rounding corners will offer better paste release. Customers should contact their board assembly site for stencil design recommendations. Refer to IPC-7525 for other stencil recommendations.
  - E. Customers should contact their board fabrication site for solder mask tolerances between and around signal pads.



PW (R-PDSO-G14)

PLASTIC SMALL OUTLINE



- NOTES:
- All linear dimensions are in millimeters.
  - This drawing is subject to change without notice.
  - Publication IPC-7351 is recommended for alternate designs.
  - Laser cutting apertures with trapezoidal walls and also rounding corners will offer better paste release. Customers should contact their board assembly site for stencil design recommendations. Refer to IPC-7525 for other stencil recommendations.
  - Customers should contact their board fabrication site for solder mask tolerances between and around signal pads.

N (R-PDIP-T\*\*)

PLASTIC DUAL-IN-LINE PACKAGE

16 PINS SHOWN

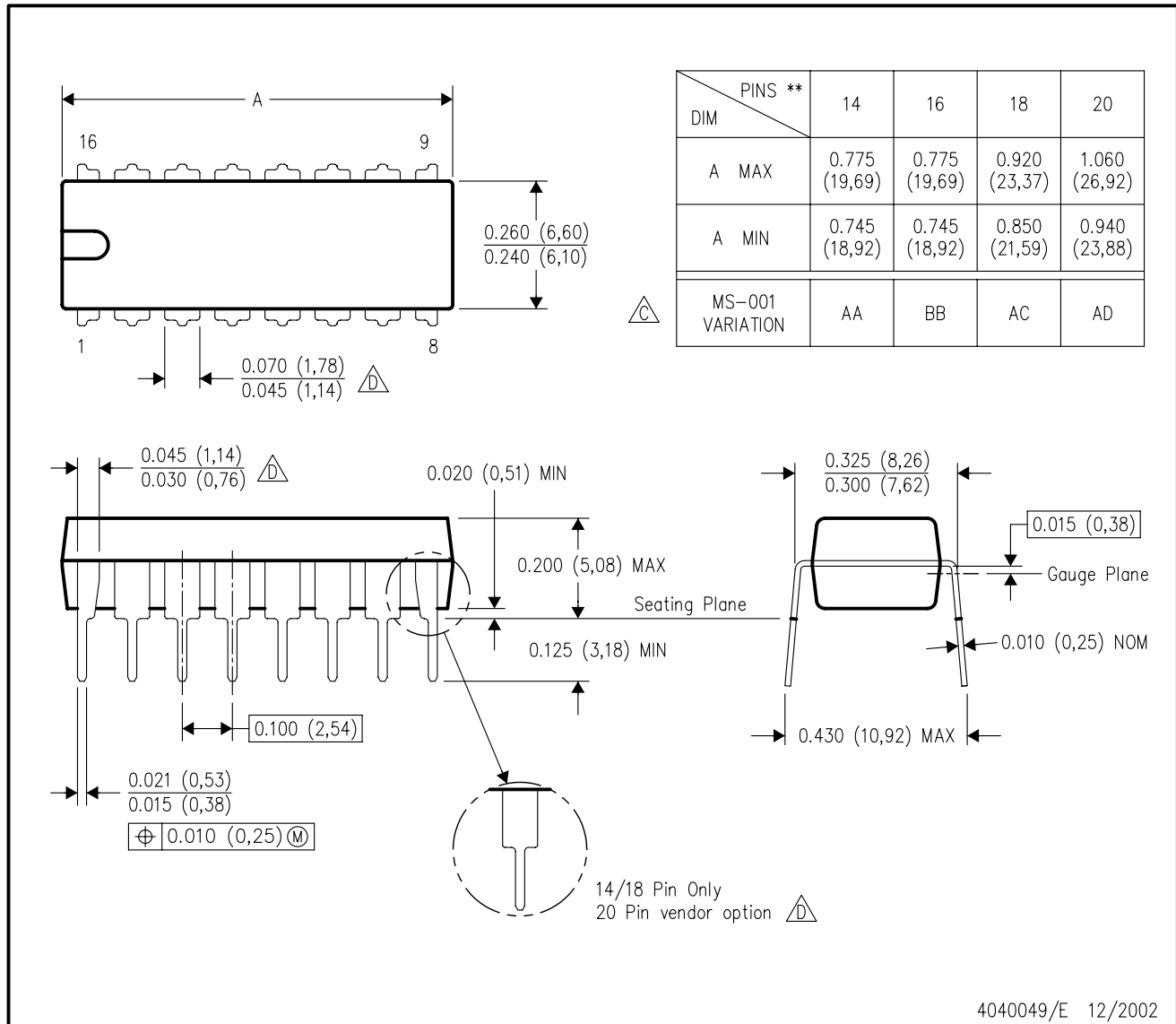

- NOTES:
- A. All linear dimensions are in inches (millimeters).
  - B. This drawing is subject to change without notice.
  - (C) Falls within JEDEC MS-001, except 18 and 20 pin minimum body length (Dim A).
  - (D) The 20 pin end lead shoulder width is a vendor option, either half or full width.

DB (R-PDSO-G\*\*)

PLASTIC SMALL-OUTLINE

28 PINS SHOWN



- NOTES: A. All linear dimensions are in millimeters.  
 B. This drawing is subject to change without notice.  
 C. Body dimensions do not include mold flash or protrusion not to exceed 0,15.  
 D. Falls within JEDEC MO-150

## IMPORTANT NOTICE AND DISCLAIMER

TI PROVIDES TECHNICAL AND RELIABILITY DATA (INCLUDING DATASHEETS), DESIGN RESOURCES (INCLUDING REFERENCE DESIGNS), APPLICATION OR OTHER DESIGN ADVICE, WEB TOOLS, SAFETY INFORMATION, AND OTHER RESOURCES "AS IS" AND WITH ALL FAULTS, AND DISCLAIMS ALL WARRANTIES, EXPRESS AND IMPLIED, INCLUDING WITHOUT LIMITATION ANY IMPLIED WARRANTIES OF MERCHANTABILITY, FITNESS FOR A PARTICULAR PURPOSE OR NON-INFRINGEMENT OF THIRD PARTY INTELLECTUAL PROPERTY RIGHTS.

These resources are intended for skilled developers designing with TI products. You are solely responsible for (1) selecting the appropriate TI products for your application, (2) designing, validating and testing your application, and (3) ensuring your application meets applicable standards, and any other safety, security, or other requirements. These resources are subject to change without notice. TI grants you permission to use these resources only for development of an application that uses the TI products described in the resource. Other reproduction and display of these resources is prohibited. No license is granted to any other TI intellectual property right or to any third party intellectual property right. TI disclaims responsibility for, and you will fully indemnify TI and its representatives against, any claims, damages, costs, losses, and liabilities arising out of your use of these resources.

TI's products are provided subject to TI's Terms of Sale ([www.ti.com/legal/termsofsale.html](http://www.ti.com/legal/termsofsale.html)) or other applicable terms available either on [ti.com](http://ti.com) or provided in conjunction with such TI products. TI's provision of these resources does not expand or otherwise alter TI's applicable warranties or warranty disclaimers for TI products.

Mailing Address: Texas Instruments, Post Office Box 655303, Dallas, Texas 75265  
Copyright © 2019, Texas Instruments Incorporated

## Looking for pricing, stock, or lifecycle information?

Click below to explore more details on WIN SOURCE:

 [View SN74HC132PWRG4 on WIN SOURCE](#)

 [Texas Instruments](#) Information

## Optimize Your Supply Chain with WIN SOURCE Solutions

-  Global Sourcing Solution
-  Obsolete Management
-  Cost Control Management
-  Shortage Management
-  Alternative Solution
-  Excess Inventory Management