

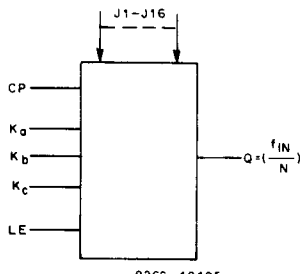

**THE DATASHEET OF
CD54HC540F3A**



High-Speed CMOS Logic



FUNCTIONAL DIAGRAM

CMOS Programmable
Divide-by-"N" Counter

Type Features:

- Synchronous programmable $\div N$ counter:
 $N = 3$ to 9999 or 15999
- Presetable down-counter
- Fully static operation
- Mode-select control of initial decade counting function ($\div 10, 8, 5, 4, 2$)
- Master preset initialization
- Latchable $\div N$ output

The RCA-CD54/74HC4059 and the CD54/74HCT4059 are high-speed silicon-gate devices that are pin-compatible with the CD4059B devices of the CD4000B series. These devices are divide-by- N down-counters that can be programmed to divide an input frequency by any number "N" from 3 to 15,999. The output signal is a pulse one clock cycle wide occurring at a rate equal to the input frequency divided by N . The down-counter is preset by means of 16 jam inputs.

The three Mode-Select Inputs K_a , K_b , and K_c determine the modulus ("divide-by" number) of the first and last counting sections in accordance with the truth table shown in Table I. Every time the first (fastest) counting section goes through one cycle, it reduces by 1 the number that has been preset (jammed) into the three decades of the intermediate counting section and into the last counting section, which consists of flip-flops that are not needed for operating the first counting section. For example, in the $\div 2$ mode, only one flip-flop is needed in the first counting section. Therefore the last counting section has three flip-flops that can be preset to a maximum count of seven with a place value of thousands. If $\div 10$ is desired for the first section, K_a is set "high", K_b "high" and K_c "low". Jam inputs J_1 , J_2 , J_3 , and J_4 are used to preset the first counting section and there is no last counting section. The intermediate counting section consists of three cascaded BCD decade ($\div 10$) counters presettable by means of Jam Inputs J_5 through J_{16} .

The Mode-Select Inputs permit frequency-synthesizer channel separations of 10, 12.5, 20, 25, or 50 parts. These inputs set the maximum value of N at 9999 (when the first counting section divides by 5 or 10) or 15,999 (when the first counting section divides by 8, 4, or 2).

The three decades of the intermediate counter can be preset to a binary 15 instead of a binary 9, while their place values are still 1, 10, and 100, multiplied by the number of the $\div N$ mode. For example, in the $\div 8$ mode, the number

Family Features:

- Fanout (over temperature range):
Standard outputs - 10 LSTTL loads
Bus driver outputs - 15 LSTTL loads
- Wide operating temperature range:
CD74HC/HCT: -40 to $+85^\circ\text{C}$
- Balanced propagation delay and transition times
- Significant power reduction compared to LSTTL logic ICs
- Alternate source is Philips/Signetics
- CD54HC/CD74HC types:
2 to 6 V operation
High noise immunity:
 $N_{IL} = 30\%$, $N_{IH} = 30\%$ of V_{CC} ; @ $V_{CC} = 5\text{ V}$
- CD54HCT/CD74HCT types:
4.5 to 5.5 V operation
Direct LSTTL input logic compatibility
 $V_{IL} = 0.8\text{ V max.}$, $V_{IH} = 2\text{ V min.}$
CMOS input compatibility
 $I_i \leq 1\ \mu\text{A}$ @ V_{OL} , V_{OH}

Applications:

- Communications digital frequency synthesizers: VHF, UHF, FM, AM, etc.
- Fixed or programmable frequency division
- "Time out" timer for consumer-application industrial controls
- Companion Application Note, ICAN-6374, "Application of the CMOS CD4059A Programmable Divide-by- N Counter in FM and Citizens Band Transceiver Digital Tuners"

CD54/74HC4059 CD54/74HCT4059

from which counting down begins can be preset to:

- 3rd decade: 1500
- 2nd decade: 150
- 1st decade: 15

Last counting section 1000

The total of these numbers (2665) times 8 equals 21,320. The first counting section can be preset to 7. Therefore, 21,327 is the maximum possible count in the ÷ 8 mode.

The highest count of the various modes is shown in the column entitled Extended Counter Range of Table I. Control inputs Kb and Kc can be used to initiate and lock the counter in the "master preset" state. In this condition the flip-flops in the counter are preset in accordance with the jam inputs and the counter remains in that state as long as Kb and Kc both remain low. The counter begins to count down from the preset state when a counting mode other than the master preset mode is selected.

The counter should always be put in the master preset mode before the ÷ 5 mode is selected. Whenever the master preset mode is used, control signals Kb = "low" and Kc = "low" must be applied for at least 3 full clock pulses.

After the Master Preset Mode inputs have been changed to one of the ÷ modes, the next positive-going clock transition changes an internal flip-flop so that the countdown can begin at the second positive-going clock transition. Thus, after an MP (Master Preset) mode, there is always one extra count before the output goes high. Fig. 1 illustrates a total count of 3 (÷ 8 mode). If the Master Preset mode is started two clock cycles or less before an output pulse, the output pulse will appear at the time due. If the Master Preset Mode is not used, the counter jumps back to the "Jam" count when the output pulse appears.

A "high" on the Latch Enable input will cause the counter output to remain high once an output pulse occurs, and to remain in the high state until the latch input returns to "low". If the Latch Enable is "low", the output pulse will remain high for only 1 cycle of the clock-input signal.

The CD54HC4059 and CD54HCT4059 are supplied in 24-lead dual-in-line frit-seal ceramic packages (F suffix). The CD74HC4059 and CD74HCT4059 are supplied in 24-lead dual-in-line, narrow-body plastic packages (EN suffix), in 24-lead dual-in-line, wide-body plastic packages (E suffix), and in 24-lead dual-in-line surface-mount plastic packages (M suffix). Both types are also available in chip form (H suffix).

Table I

Mode Select Input			First Counting Section			Last Counting Section			Counter Range	
									Design	Extended
Ka	Kb	Kc	Mode	Can be preset to a max. of:	Jam* inputs used:	Mode	Can be preset to a max. of:	Jam* inputs used:	Max.	Max.
			Di-vides by:			Di-vides by:				
H	H	H	2	1	J1	8	7	J2,J3,J4	15,999	17,331
L	H	H	4	3	J1,J2	4	3	J3,J4	15,999	18,663
H	L	H	5#	4	J1,J2,J3	2	1	J4	9,999	13,329
L	L	H	8	7	J1,J2,J3	2	1	J4	15,999	21,327
H	H	L	10	9	J1,J2,J3,J4	1	0	—	9,999	16,659
X	L	L	Master Preset			Master Preset			—	—

X = Don't Care

*J1 = Least significant bit.

J4 = Most significant bit.

#Operation in the ÷ 5 mode (1st counting section) requires going through the Master Preset mode prior to going into the ÷ 5 mode. At power turn-on, Kc must be "low" for a period of 3 input clock pulses after Vcc reaches a minimum of 3 volts.

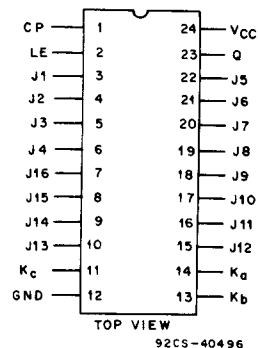

TERMINAL ASSIGNMENT

CD54/74HC4059 CD54/74HCT4059

How to Preset the CD54/74HC/HCT4059 to Desired ÷ N

The value N is determined as follows:

$$N = (\text{MODE}^*) (1000 \times \text{Decade 5 Preset} + 100 \times \text{Decade 4 Preset} + 10 \times \text{Decade 3 Preset} + 1 \times \text{Decade 2 Preset}) + \text{Decade 1 Preset} \tag{1}$$

*MODE = First counting section divider (10, 8, 5, 4, or 2)

To calculate preset values for any N count, divide the N count by the Mode. The resultant is the corresponding preset values of the 5th through 2nd decade with the remainder being equal to the 1st decade value.

$$\text{Preset Value} = \frac{N}{\text{Mode}} \tag{2}$$

Example:

N = 8479, Mode = 5

Mode Select = 5		
Ka	Kb	Kc
H	L	H



Program Jam Inputs (BCD)

4			1	5				9				6			
J1	J2	J3	J4	J5	J6	J7	J8	J9	J10	J11	J12	J13	J14	J15	J16
L	L	H	H	H	L	H	L	H	L	L	H	L	H	H	L

To verify the results, use Equation 1:

$$N = 5 (1000 \times 1 + 100 \times 6 + 10 \times 9 + 1 \times 5) + 4$$

$$N = 8479$$

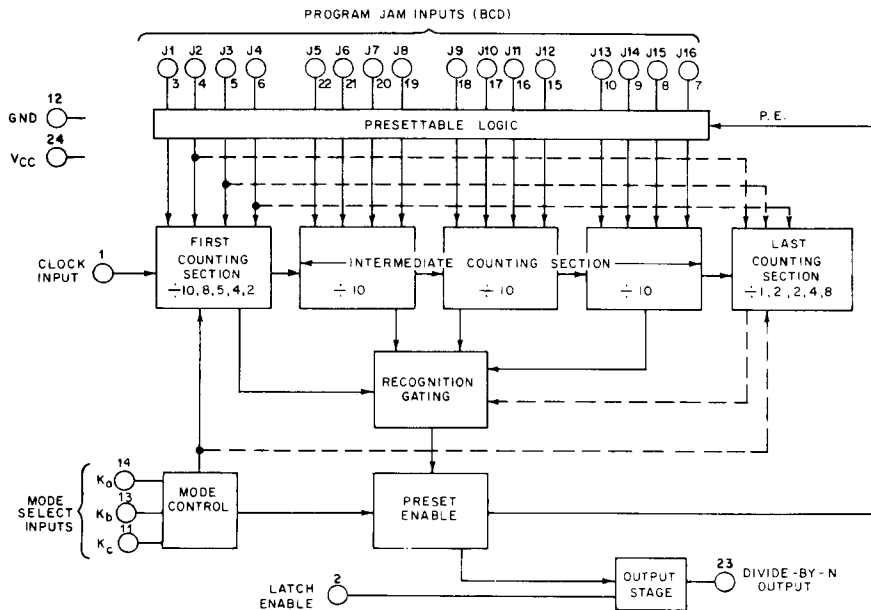

92CM-22213R1

Fig. 1 - Functional block diagram.

CD54/74HC4059 CD54/74HCT4059

MAXIMUM RATINGS, Absolute-Maximum Values:

DC SUPPLY-VOLTAGE, (V _{CC}):	
(Voltages referenced to ground)	-0.5 to +7 V
DC INPUT DIODE CURRENT, I _{IK} (FOR V _i < -0.5 V OR V _i > V _{CC} +0.5 V)	±20 mA
DC OUTPUT DIODE CURRENT, I _{OK} (FOR V _o < -0.5 V OR V _o > V _{CC} +0.5 V)	±20 mA
DC DRAIN CURRENT, PER OUTPUT (I _o) (FOR -0.5 V < V _o < V _{CC} +0.5 V)	±25 mA
DC V _{CC} OR GROUND CURRENT (I _{CC})	±50 mA
POWER DISSIPATION PER PACKAGE (P _D):	
For T _A = -40 to +60°C (PACKAGE TYPE E)	500 mW
For T _A = +60 to +85°C (PACKAGE TYPE E)	Derate Linearly at 8 mW/°C to 300 mW
For T _A = -55 to +100°C (PACKAGE TYPE F,H)	500 mW
For T _A = +100 to +125°C (PACKAGE TYPE F,H)	Derate Linearly at 8 mW/°C to 300 mW
For T _A = -40 to +70°C (PACKAGE TYPE M)	400 mW
For T _A = +70 to +125°C (PACKAGE TYPE M)	Derate Linearly at 6 mW/°C to 70 mW
OPERATING-TEMPERATURE RANGE (T _A):	
PACKAGE TYPE F,H	-55 to +125°C
PACKAGE TYPE E,M	-40 to +85°C
STORAGE TEMPERATURE (T _{stg})	-65 to +150°C
LEAD TEMPERATURE (DURING SOLDERING):	
At distance 1/16 ± 1/32 in. (1.59 ± 0.79 mm) from case for 10 s max.	+265°C
Unit inserted into a PC Board (min. thickness 1/16 in., 1.59 mm) with solder contacting lead tips only	+300°C

RECOMMENDED OPERATING CONDITIONS

For maximum reliability, nominal operating conditions should be selected so that operation is always within the following ranges:

CHARACTERISTIC	LIMITS		UNITS
	MIN.	MAX.	
Supply-Voltage Range (For T _A =Full Package Temperature Range) V _{CC} .*			
CD54/74HC Types	2	6	V
CD54/74HCT Types	4.5	5.5	
DC Input or Output Voltage, V _i , V _o	0	V _{CC}	V
Operating Temperature, T _A :			
CD74 Types	-40	+85	°C
CD54 Types	-55	+125	
Input Rise and Fall Times, t _r , t _f :			
at 2 V	0	1000	ns
at 4.5 V	0	500	
at 6 V	0	400	

*Unless otherwise specified, all voltages are referenced to Ground.

CD54/74HC4059 CD54/74HCT4059

STATIC ELECTRICAL CHARACTERISTICS

CHARACTERISTIC	CD74HC4059/CD54HC4059										CD74HCT4059/CD54HCT4059								UNITS				
	TEST CONDITIONS			74HC/54HC TYPES			74HC TYPES		54HC TYPES			TEST CONDITIONS		74HCT/54HCT TYPES			74HCT TYPES			54HCT TYPES			
	V _I V	I _O mA	V _{CC} V	+25° C			-40/ +85° C		-55/ +125° C			V _I V	V _{CC} V	+25° C			-40/ +85° C			-55/ +125° C			
				Min	Typ	Max	Min	Max	Min	Max	Min			Max	Min	Typ	Max	Min		Max	Min	Max	
High-Level Input Voltage	V _{IH}			2	1.5	—	—	1.5	—	1.5	—	—	4.5			2	—	—	2	—	2	—	V
				4.5	3.15	—	—	3.15	—	3.15	—	—	5.5										
				6	4.2	—	—	4.2	—	4.2	—												
Low-Level Input Voltage	V _{IL}			2	—	—	0.5	—	0.5	—	0.5	—	4.5					0.8	—	0.8	—	0.8	V
				4.5	—	—	1.35	—	1.35	—	1.35	—	to										
				6	—	—	1.8	—	1.8	—	1.8	—	5.5										
High-Level Output Voltage	V _{OH}	V _{IL} or V _{IH}	-0.02	2	1.9	—	—	1.9	—	1.9	—	V _{IL} or V _{IH}	4.5	4.4	—	—	4.4	—	4.4	—	4.4	—	V
CMOS Loads				4.5	4.4	—	—	4.4	—	4.4	—												
				6	5.9	—	—	5.9	—	5.9	—												
TTL Loads		V _{IL} or V _{IH}		-4	4.5	3.98	—	—	3.84	—	3.7	—	V _{IL} or V _{IH}	4.5	3.98	—	—	3.84	—	3.7	—		V
				-5.2	6	5.48	—	—	5.34	—	5.2	—											
Low-Level Output Voltage	V _{OL}	V _{IL} or V _{IH}	0.02	2	—	—	0.1	—	0.1	—	0.1	V _{IL} or V _{IH}	4.5	—	—	0.1	—	0.1	—	0.1	—	0.1	V
CMOS Loads				6	—	—	0.1	—	0.1	—	0.1												
TTL Loads		V _{IL} or V _{IH}		4	4.5	—	—	0.26	—	0.33	—	0.4	V _{IL} or V _{IH}	4.5	—	—	0.26	—	0.33	—	0.4	—	V
				5.2	6	—	—	0.26	—	0.33	—	0.4											
Input Leakage Current	I _I	V _{CC} or Gnd		6	—	—	±0.1	—	±1	—	±1	Any Voltage Between V _{CC} & Gnd	5.5	—	—	±0.1	—	±1	—	±1	—	±1	μA
Quiescent Device Current	I _{CC}	V _{CC} or Gnd	0	6	—	—	8	—	80	—	160	V _{CC} or Gnd	5.5	—	—	8	—	80	—	160	—	160	μA
Additional Quiescent Device Current per input pin: 1 unit load	ΔI _{CC} *											V _{CC} -2.1	4.5 to 5.5	—	100	360	—	450	—	490	—	490	μA

*For dual-supply systems theoretical worst case (V_I = 2.4 V, V_{CC} = 5.5 V) specification is 1.8 mA.

HCT Input Loading Table

Input	Unit Loads*
All J Inputs	0.5
CP	0.65
LE	1.65
Ka	1
Kb	1.5
Kc	0.85

*Unit Load is ΔI_{CC} limit specified in Static Characteristics Chart, e.g., 360 μA max. @ 25° C.

CD54/74HC4059 CD54/74HCT4059

SWITCHING CHARACTERISTICS (V_{CC}=5 V, T_A=25° C, Input t_r=6 ns)

CHARACTERISTIC		C _L (pF)	TYPICAL VALUES		UNITS
			HC	HCT	
Propagation Delay: CP to Q	t _{PLH}	15	17	19	ns
	t _{PHL}		14	19	
CP Frequency	f _{MAX}	15	54	50	MHz
Power Dissipation Capacitance*	C _{PD}	—	36	36	pF

*C_{PD} is used to determine the dynamic power consumption, per package.

$$P_D = C_{PD} V_{CC}^2 f_i + \sum C_L V_{CC}^2 f_o$$

where f_i = input frequency
 f_o = output frequency
 C_L = output load capacitance
 V_{CC} = supply voltage.

PRE-REQUISITE FOR SWITCHING FUNCTION

CHARACTERISTIC	TEST CONDITIONS	LIMITS										UNITS			
		25° C				-40° C to +85° C				-55° C to +125° C					
		HC		HCT		74HC		74HCT		54HC			54HCT		
V _{CC} (V)	Min.	Max.	Min.	Max.	Min.	Max.	Min.	Max.	Min.	Max.	Min.	Max.			
Pulse Width CP	t _w	2	90	—	—	—	115	—	—	—	135	—	—	—	ns
		4.5	18	—	20	—	23	—	25	—	27	—	30	—	
		6	15	—	—	—	20	—	—	—	23	—	—	—	
Setup Time Kb, Kc to CP	t _{su}	2	75	—	—	—	95	—	—	—	110	—	—	—	ns
		4.5	15	—	15	—	19	—	19	—	22	—	22	—	
		6	13	—	—	—	16	—	—	—	19	—	—	—	
CP Frequency	f _{MAX}	2	5	—	—	—	4	—	—	—	4	—	—	—	MHz
		4.5	27	—	25	—	22	—	20	—	18	—	17	—	
		6	32	—	—	—	26	—	—	—	21	—	—	—	

CD54/74HC4059 CD54/74HCT4059

SWITCHING CHARACTERISTICS (C_L=50 pF, Input t_r,t_f=6 ns)

CHARACTERISTIC	VCC (V)	LIMITS										UNITS			
		25° C				-40° C to +85° C				-55° C to +125° C					
		HC		HCT		74HC		74HCT		54HC			54HCT		
		Min.	Max.	Min.	Max.	Min.	Max.	Min.	Max.	Min.	Max.		Min.	Max.	
Propagation Delay	t _{PLH}	2	—	200	—	—	—	250	—	—	—	300	—	—	ns
	t _{PHL}	4.5	—	40	—	46	—	50	—	58	—	60	—	69	
	CP to Q	6	—	34	—	—	—	43	—	—	—	51	—	—	
LE to Q	2	—	175	—	—	—	220	—	—	—	265	—	—	ns	
	4.5	—	35	—	46	—	44	—	58	—	53	—	69		
	6	—	30	—	—	—	37	—	—	—	45	—	—		
Output Transition Time	t _{TLH}	2	—	75	—	—	—	95	—	—	—	110	—	—	
	t _{THL}	4.5	—	15	—	15	—	19	—	19	—	22	—	22	
	6	—	13	—	—	—	16	—	—	—	19	—	—		
Input Capacitance	C _i	—	—	10	—	10	—	10	—	10	—	10	—	pF	

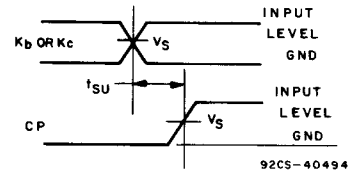
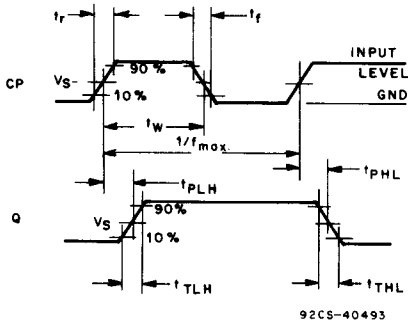



	54/74HC	54/74HCT
Input Level	V _{CC}	3 V
Switching Voltage, V _s	50% V _{CC}	1.3 V

Fig. 2 - Transition times, propagation delay times, and setup times.

Looking for pricing, stock, or lifecycle information?

Click below to explore more details on WIN SOURCE:

-  [View CD54HC540F3A](#) on WIN SOURCE
-  [Harris Corporation](#) Information

Optimize Your Supply Chain with WIN SOURCE Solutions

-  Global Sourcing Solution
-  Obsolete Management
-  Cost Control Management
-  Shortage Management
-  Alternative Solution
-  Excess Inventory Management