



**THE DATASHEET OF  
CY2308SXI-5H**



## Features

- Zero input-output propagation delay, adjustable by capacitive load on FBK input
- Multiple configurations, see [Available CY2308 Configurations](#) on page 3
- Multiple low skew outputs
- Two banks of four outputs, three-stateable by two select inputs
- 10 MHz to 133 MHz operating range
- 75 ps typical cycle-to-cycle jitter (15 pF, 66 MHz)
- Space saving 16-pin 150 mil SOIC package or 16-pin TSSOP
- 3.3V operation
- Industrial temperature available

## Functional Description

The CY2308 is a 3.3V Zero Delay Buffer designed to distribute high speed clocks in PC, workstation, datacom, telecom, and other high performance applications.

The part has an on-chip PLL that locks to an input clock presented on the REF pin. The PLL feedback is driven into the FBK pin and obtained from one of the outputs. The input-to-output skew is less than 350 ps and output-to-output skew is less than 200 ps.

The CY2308 has two banks of four outputs each that is controlled by the select inputs as shown in the table [Select Input Decoding](#) on page 2. If all output clocks are not required, Bank B is three-stated. The input clock is directly applied to the output for chip and system testing purposes by the select inputs.

The CY2308 PLL enters a power down state when there are no rising edges on the REF input. In this mode, all outputs are three-stated and the PLL is turned off resulting in less than 50  $\mu$ A of current draw. The PLL shuts down in two additional cases as shown in the table [Select Input Decoding](#) on page 2.

Multiple CY2308 devices accept the same input clock and distribute it in a system. In this case, the skew between the outputs of two devices is less than 700 ps.

The CY2308 is available in five different configurations as shown in the table [Available CY2308 Configurations](#) on page 3. The CY2308-1 is the base part where the output frequencies equal the reference if there is no counter in the feedback path. The CY2308-1H is the high drive version of the -1 and rise and fall times on this device are much faster.

The CY2308-2 enables the user to obtain 2X and 1X frequencies on each output bank. The exact configuration and output frequencies depend on the output that drives the feedback pin. The CY2308-3 enables the user to obtain 4X and 2X frequencies on the outputs.

The CY2308-4 enables the user to obtain 2X clocks on all outputs. Thus, the part is extremely versatile and is used in a variety of applications.

The CY2308-5H is a high drive version with REF/2 on both banks.

## Logic Block Diagram

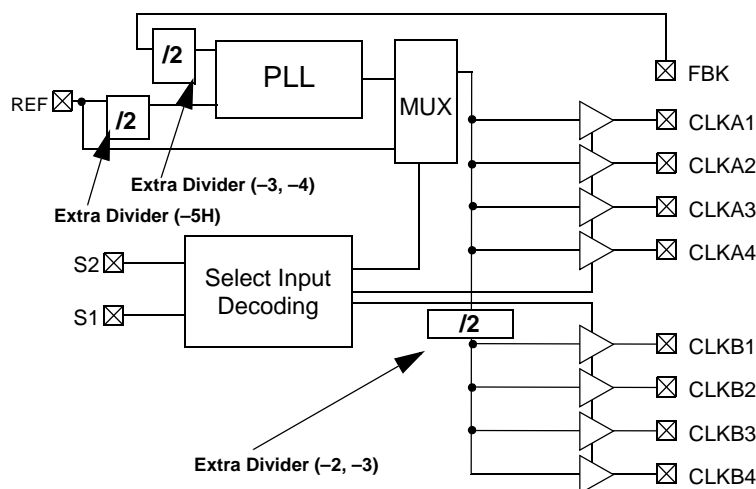

## Pinouts

Figure 1. Pin Diagram - 16 Pin SOIC (Top view)

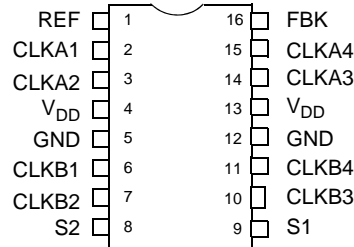

Table 1. Pin Definitions - 16 Pin SOIC

| Pin | Signal               | Description                                  |
|-----|----------------------|--|
| 1   | REF <sup>[1]</sup>   | Input reference frequency, 5V tolerant input |
| 2   | CLKA1 <sup>[2]</sup> | Clock output, Bank A                         |
| 3   | CLKA2 <sup>[2]</sup> | Clock output, Bank A                         |
| 4   | V <sub>DD</sub>      | 3.3V supply                                  |
| 5   | GND                  | Ground                                       |
| 6   | CLKB1 <sup>[2]</sup> | Clock output, Bank B                         |
| 7   | CLKB2 <sup>[2]</sup> | Clock output, Bank B                         |
| 8   | S2 <sup>[3]</sup>    | Select input, bit 2                          |
| 9   | S1 <sup>[3]</sup>    | Select input, bit 1                          |
| 10  | CLKB3 <sup>[2]</sup> | Clock output, Bank B                         |
| 11  | CLKB4 <sup>[2]</sup> | Clock output, Bank B                         |
| 12  | GND                  | Ground                                       |
| 13  | V <sub>DD</sub>      | 3.3V supply                                  |
| 14  | CLKA3 <sup>[2]</sup> | Clock output, Bank A                         |
| 15  | CLKA4 <sup>[2]</sup> | Clock output, Bank A                         |
| 16  | FBK                  | PLL feedback input                           |

## Select Input Decoding

| S2 | S1 | CLOCK A1–A4           | CLOCK B1–B4           | Output Source | PLL Shutdown |
|----|----|-----------------------|-----------------------|---------------|--------------|
| 0  | 0  | Tri-State             | Tri-State             | PLL           | Y            |
| 0  | 1  | Driven                | Tri-State             | PLL           | N            |
| 1  | 0  | Driven <sup>[4]</sup> | Driven <sup>[4]</sup> | Reference     | Y            |
| 1  | 1  | Driven                | Driven                | PLL           | N            |

### Notes

1. Weak pull down.
2. Weak pull down on all outputs.
3. Weak pull ups on these inputs.
4. Outputs inverted on 2308–2 and 2308–3 in bypass mode, S2 = 1 and S1 = 0.

### Available CY2308 Configurations

| Device    | Feedback From    | Bank A Frequency | Bank B Frequency                      |
|-----------|------------------|------------------|---------------------------------------|
| CY2308-1  | Bank A or Bank B | Reference        | Reference                             |
| CY2308-1H | Bank A or Bank B | Reference        | Reference                             |
| CY2308-2  | Bank A           | Reference        | Reference/2                           |
| CY2308-2  | Bank B           | 2 X Reference    | Reference                             |
| CY2308-3  | Bank A           | 2 X Reference    | Reference or Reference <sup>[5]</sup> |
| CY2308-3  | Bank B           | 4 X Reference    | 2 X Reference                         |
| CY2308-4  | Bank A or Bank B | 2 X Reference    | 2 X Reference                         |
| CY2308-5H | Bank A or Bank B | Reference /2     | Reference /2                          |

### Zero Delay and Skew Control

Figure 2. REF. Input to CLKA/CLKB Delay Versus Difference in Loading between FBK Pin and CLKA/CLKB Pins

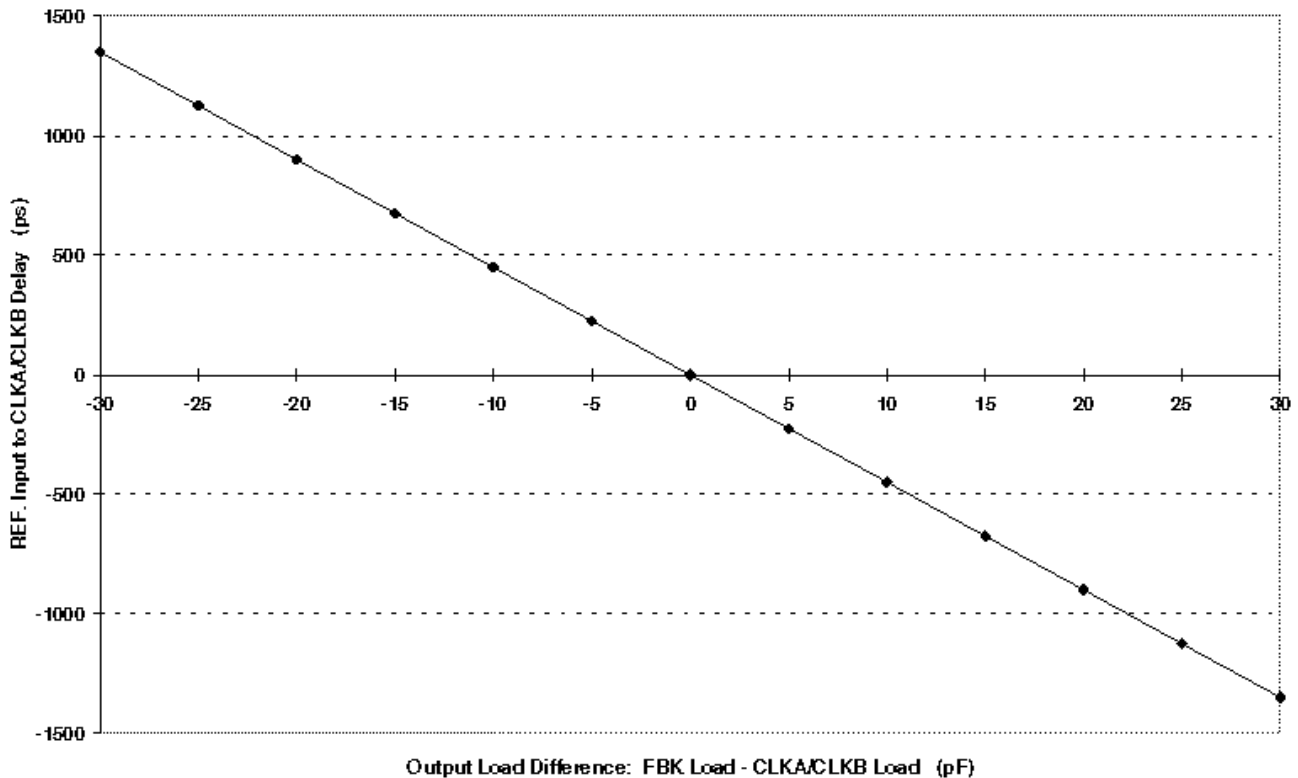

To close the feedback loop of the CY2308, the FBK pin is driven from any of the eight available output pins. The output driving the FBK pin drives a total load of 7 pF plus any additional load that it drives. The relative loading of this output to the remaining outputs adjusts the input-output delay. This is shown in the Figure 2.

For applications requiring zero input-output delay, all outputs including the one providing feedback is equally loaded.

If input-output delay adjustments are required, use the [Zero Delay and Skew Control](#) graph to calculate loading differences between the feedback output and remaining outputs.

For zero output-output skew, outputs are loaded equally. For further information on using CY2308, refer to the application note "CY2308: Zero Delay Buffer."

**Note**

5. Output phase is indeterminant (0° or 180° from input clock). If phase integrity is required, use the CY2308-2.

## Maximum Ratings

|   |                          |   |        |
|---|--------------------------|---|--------|
| Supply Voltage to Ground Potential..... | -0.5V to +7.0V           | Junction Temperature.....                                   | 150°C  |
| DC Input Voltage (Except Ref) .....     | -0.5V to $V_{DD} + 0.5V$ | Static Discharge Voltage<br>(MIL-STD-883, Method 3015)..... | >2000V |
| DC Input Voltage REF .....              | -0.5 to 7V               |   |        |
| Storage Temperature .....               | -65°C to +150°C          |   |        |

## Operating Conditions for Commercial Temperature Devices

| Parameter | Description   | Min  | Max | Unit |
|-----------|---|------|-----|------|
| $V_{DD}$  | Supply Voltage  | 3.0  | 3.6 | V    |
| $T_A$     | Operating Temperature (Ambient Temperature)   | 0    | 70  | °C   |
| $C_L$     | Load Capacitance, below 100 MHz   | -    | 30  | pF   |
|           | Load Capacitance, from 100 MHz to 133 MHz   | -    | 15  | pF   |
| $C_{IN}$  | Input Capacitance <sup>[6]</sup>  | -    | 7   | pF   |
| $t_{PU}$  | Power up time for all $V_{DD}$ s to reach minimum specified voltage (power ramps must be monotonic) | 0.05 | 50  | ms   |

## Electrical Characteristics for Commercial Temperature Devices

| Parameter          | Description                        | Test Conditions   | Min | Max                | Unit |
|--------------------|------------------------------------|---|-----|--------------------|------|
| $V_{IL}$           | Input LOW Voltage                  |   | -   | 0.8                | V    |
| $V_{IH}$           | Input HIGH Voltage                 |   | 2.0 | -                  | V    |
| $I_{IL}$           | Input LOW Current                  | $V_{IN} = 0V$   | -   | 50.0               | μA   |
| $I_{IH}$           | Input HIGH Current                 | $V_{IN} = V_{DD}$   | -   | 100.0              | μA   |
| $V_{OL}$           | Output LOW Voltage <sup>[7]</sup>  | $I_{OL} = 8\text{ mA} (-1, -2, -3, -4)$<br>$I_{OL} = 12\text{ mA} (-1H, -5H)$   | -   | 0.4                | V    |
| $V_{OH}$           | Output HIGH Voltage <sup>[7]</sup> | $I_{OH} = -8\text{ mA} (-1, -2, -3, -4)$<br>$I_{OH} = -12\text{ mA} (-1H, -5H)$ | 2.4 | -                  | V    |
| $I_{DD}$ (PD mode) | Power Down Supply Current          | REF = 0 MHz   | -   | 12.0               | μA   |
| $I_{DD}$           | Supply Current                     | Unloaded outputs, 100 MHz REF,<br>Select inputs at $V_{DD}$ or GND              | -   | 45.0               | mA   |
|                    |                                    |   | -   | 70.0<br>(-1H, -5H) | mA   |
|                    |                                    | Unloaded outputs, 66 MHz REF<br>(-1, -2, -3, -4)                                | -   | 32.0               | mA   |
|                    |                                    | Unloaded outputs, 33 MHz REF<br>(-1, -2, -3, -4)                                | -   | 18.0               | mA   |

## Switching Characteristics for Commercial Temperature Devices

| Parameter <sup>[8]</sup> | Name  | Test Conditions  | Min  | Typ. | Max   | Unit |
|--------------------------|---|--|------|------|-------|------|
| $t_1$                    | Output Frequency  | 30 pF load, All devices                                      | 10   | -    | 100   | MHz  |
| $t_1$                    | Output Frequency  | 20 pF load, -1H, -5H devices <sup>[9]</sup>                  | 10   | -    | 133.3 | MHz  |
| $t_1$                    | Output Frequency  | 15 pF load, -1, -2, -3, -4 devices                           | 10   | -    | 133.3 | MHz  |
| $t_{PD}$                 | Duty Cycle <sup>[7, 8]</sup> = $t_2 \div t_1$<br>(-1, -2, -3, -4, -1H, -5H) | Measured at 1.4V, $F_{OUT} = 66.66\text{ MHz}$<br>30 pF load | 40.0 | 50.0 | 60.0  | %    |
| $t_{PD}$                 | Duty Cycle <sup>[7, 8]</sup> = $t_2 \div t_1$<br>(-1, -2, -3, -4, -1H, -5H) | Measured at 1.4V, $F_{OUT} < 50\text{ MHz}$<br>15 pF load    | 45.0 | 50.0 | 55.0  | %    |

### Notes

- Applies to both Ref Clock and FBK.
- Parameter is guaranteed by design and characterization. Not 100% tested in production.
- All parameters are specified with loaded outputs.
- CY2308-5H has maximum input frequency of 133.33 MHz and maximum output of 66.67 MHz.

**Switching Characteristics for Commercial Temperature Devices** (continued)

| Parameter <sup>[8]</sup> | Name  | Test Conditions   | Min | Typ. | Max  | Unit |
|--------------------------|---|---|-----|------|------|------|
| t <sub>3</sub>           | Rise Time <sup>[7, 8]</sup><br>(-1, -2, -3, -4)                             | Measured between 0.8V and 2.0V,<br>30 pF load                             | -   | -    | 2.20 | ns   |
| t <sub>3</sub>           | Rise Time <sup>[7, 8]</sup><br>(-1, -2, -3, -4)                             | Measured between 0.8V and 2.0V,<br>15 pF load                             | -   | -    | 1.50 | ns   |
| t <sub>3</sub>           | Rise Time <sup>[7, 8]</sup><br>(-1H, -5H)                                   | Measured between 0.8V and 2.0V,<br>30 pF load                             | -   | -    | 1.50 | ns   |
| t <sub>4</sub>           | Fall Time <sup>[7, 8]</sup><br>(-1, -2, -3, -4)                             | Measured between 0.8V and 2.0V,<br>30 pF load                             | -   | -    | 2.20 | ns   |
| t <sub>4</sub>           | Fall Time <sup>[7, 8]</sup><br>(-1, -2, -3, -4)                             | Measured between 0.8V and 2.0V,<br>15 pF load                             | -   | -    | 1.50 | ns   |
| t <sub>4</sub>           | Fall Time <sup>[7, 8]</sup><br>(-1H, -5H)                                   | Measured between 0.8V and 2.0V,<br>30 pF load                             | -   | -    | 1.25 | ns   |
| t <sub>5</sub>           | Output to Output Skew on<br>same Bank<br>(-1, -2, -3, -4) <sup>[7, 8]</sup> | All outputs equally loaded  | -   | -    | 200  | ps   |
|                          | Output to Output Skew (-1H,<br>-5H)   | All outputs equally loaded  | -   | -    | 200  | ps   |
|                          | Output Bank A to Output<br>Bank B Skew (-1, -4, -5H)                        | All outputs equally loaded  | -   | -    | 200  | ps   |
|                          | Output Bank A to Output<br>Bank B Skew (-2, -3)                             | All outputs equally loaded  | -   | -    | 400  | ps   |
| t <sub>6</sub>           | Delay, REF Rising Edge to<br>FBK Rising Edge <sup>[7, 8]</sup>              | Measured at V <sub>DD</sub> /2  | -   | 0    | ±250 | ps   |
| t <sub>7</sub>           | Device to Device Skew <sup>[7, 8]</sup>                                     | Measured at V <sub>DD</sub> /2 on the FBK pins<br>of devices              | -   | 0    | 700  | ps   |
| t <sub>8</sub>           | Output Slew Rate <sup>[7, 8]</sup>  | Measured between 0.8V and 2.0V on<br>-1H, -5H device using Test Circuit 2 | 1   | -    |      | V/ns |
| t <sub>J</sub>           | Cycle to Cycle Jitter <sup>[7, 8]</sup><br>(-1, -1H, -4, -5H)               | Measured at 66.67 MHz, loaded<br>outputs,<br>15 pF load                   | -   | 75   | 200  | ps   |
|                          |   | Measured at 66.67 MHz, loaded<br>outputs,<br>30 pF load                   | -   | -    | 200  | ps   |
|                          |   | Measured at 133.3 MHz, loaded<br>outputs,<br>15 pF load                   | -   | -    | 100  | ps   |
| t <sub>J</sub>           | Cycle to Cycle Jitter <sup>[7, 8]</sup><br>(-2, -3)                         | Measured at 66.67 MHz, loaded<br>outputs<br>30 pF load                    | -   | -    | 400  | ps   |
|                          |   | Measured at 66.67 MHz, loaded<br>outputs<br>15 pF load                    | -   | -    | 400  | ps   |
| t <sub>LOCK</sub>        | PLL Lock Time <sup>[7, 8]</sup>   | Stable power supply, valid clocks<br>presented on REF and FBK pins        | -   | -    | 1.0  | ms   |

## Operating Conditions for Industrial Temperature Devices

| Parameter       | Description  | Min  | Max | Unit |
|-----------------|--|------|-----|------|
| V <sub>DD</sub> | Supply Voltage   | 3.0  | 3.6 | V    |
| T <sub>A</sub>  | Operating Temperature (Ambient Temperature)  | -40  | 85  | °C   |
| C <sub>L</sub>  | Load Capacitance, below 100 MHz  | –    | 30  | pF   |
|                 | Load Capacitance, from 100 MHz to 133 MHz  | –    | 15  | pF   |
| C <sub>IN</sub> | Input Capacitance <sup>[6]</sup>   | –    | 7   | pF   |
| t <sub>PU</sub> | Power up time for all V <sub>DD</sub> s to reach minimum specified voltage (power ramps must be monotonic) | 0.05 | 50  | ms   |

## Electrical Characteristics for Industrial Temperature Devices

| Parameter                 | Description                           | Test Conditions   | Min | Max          | Unit |
|---------------------------|---------------------------------------|---|-----|--------------|------|
| V <sub>IL</sub>           | Input LOW Voltage                     |   | –   | 0.8          | V    |
| V <sub>IH</sub>           | Input HIGH Voltage                    |   | 2.0 | –            | V    |
| I <sub>IL</sub>           | Input LOW Current                     | V <sub>IN</sub> = 0V  | –   | 50.0         | μA   |
| I <sub>IH</sub>           | Input HIGH Current                    | V <sub>IN</sub> = V <sub>DD</sub>   | –   | 100.0        | μA   |
| V <sub>OL</sub>           | Output LOW Voltage <sup>[7, 8]</sup>  | I <sub>OL</sub> = 8 mA (-1, -2, -3, -4)<br>I <sub>OL</sub> = 12 mA (-1H, -5H)   | –   | 0.4          | V    |
| V <sub>OH</sub>           | Output HIGH Voltage <sup>[7, 8]</sup> | I <sub>OH</sub> = -8 mA (-1, -2, -3, -4)<br>I <sub>OH</sub> = -12 mA (-1H, -5H) | 2.4 | –            | V    |
| I <sub>DD</sub> (PD mode) | Power Down Supply Current             | REF = 0 MHz   | –   | 25.0         | μA   |
| I <sub>DD</sub>           | Supply Current                        | Unloaded outputs, 100 MHz, Select inputs at V <sub>DD</sub> or GND              | –   | 45.0         | mA   |
|                           |                                       |   | –   | 70(-1H, -5H) | mA   |
|                           |                                       | Unloaded outputs, 66 MHz REF (-1, -2, -3, -4)                                   | –   | 35.0         | mA   |
|                           |                                       | Unloaded outputs, 66 MHz REF (-1, -2, -3, -4)                                   | –   | 20.0         | mA   |

## Switching Characteristics for Industrial Temperature Devices

| Parameter <sup>[8]</sup> | Name   | Test Conditions  | Min  | Typ  | Max   | Unit |
|--------------------------|--|--|------|------|-------|------|
| t <sub>1</sub>           | Output Frequency   | 30 pF load, All devices                                      | 10   | –    | 100   | MHz  |
| t <sub>1</sub>           | Output Frequency   | 20 pF load, -1H, -5H devices <sup>[9]</sup>                  | 10   | –    | 133.3 | MHz  |
| t <sub>1</sub>           | Output Frequency   | 15 pF load, -1, -2, -3, -4 devices                           | 10   | –    | 133.3 | MHz  |
| t <sub>PD</sub>          | Duty Cycle <sup>[7, 8]</sup> = t <sub>2</sub> ÷ t <sub>1</sub><br>(-1, -2, -3, -4, -1H, -5H) | Measured at 1.4V, F <sub>OUT</sub> = 66.66 MHz<br>30 pF load | 40.0 | 50.0 | 60.0  | %    |
| t <sub>PD</sub>          | Duty Cycle <sup>[7, 8]</sup> = t <sub>2</sub> ÷ t <sub>1</sub><br>(-1, -2, -3, -4, -1H, -5H) | Measured at 1.4V, F <sub>OUT</sub> < 50 MHz<br>15 pF load    | 45.0 | 50.0 | 55.0  | %    |
| t <sub>3</sub>           | Rise Time <sup>[7, 8]</sup><br>(-1, -2, -3, -4)  | Measured between 0.8V and 2.0V,<br>30 pF load                | –    | –    | 2.50  | ns   |
| t <sub>3</sub>           | Rise Time <sup>[7, 8]</sup><br>(-1, -2, -3, -4)  | Measured between 0.8V and 2.0V,<br>15 pF load                | –    | –    | 1.50  | ns   |
| t <sub>3</sub>           | Rise Time <sup>[7, 8]</sup><br>(-1H, -5H)  | Measured between 0.8V and 2.0V,<br>30 pF load                | –    | –    | 1.50  | ns   |
| t <sub>4</sub>           | Fall Time <sup>[7, 8]</sup><br>(-1, -2, -3, -4)  | Measured between 0.8V and 2.0V,<br>30 pF load                | –    | –    | 2.50  | ns   |
| t <sub>4</sub>           | Fall Time <sup>[7, 8]</sup><br>(-1, -2, -3, -4)  | Measured between 0.8V and 2.0V,<br>15 pF load                | –    | –    | 1.50  | ns   |

**Switching Characteristics for Industrial Temperature Devices** (continued)

| Parameter <sup>[8]</sup> | Name   | Test Conditions   | Min | Typ | Max  | Unit |
|--------------------------|--|---|-----|-----|------|------|
| t <sub>4</sub>           | Fall Time <sup>[7, 8]</sup><br>(-1H, -5H)                                | Measured between 0.8V and 2.0V,<br>30 pF load                             | -   | -   | 1.25 | ns   |
| t <sub>5</sub>           | Output to Output Skew on<br>same Bank (-1, -2, -3, -4) <sup>[7, 8]</sup> | All outputs equally loaded  | -   | -   | 200  | ps   |
|                          | Output to Output Skew<br>(-1H, -5H)                                      | All outputs equally loaded  | -   | -   | 200  | ps   |
|                          | Output Bank A to Output Bank<br>B Skew (-1, -4, -5H)                     | All outputs equally loaded  | -   | -   | 200  | ps   |
|                          | Output Bank A to Output Bank<br>B Skew (-2, -3)                          | All outputs equally loaded  | -   | -   | 400  | ps   |
| t <sub>6</sub>           | Delay, REF Rising Edge to<br>FBK Rising Edge <sup>[7, 8]</sup>           | Measured at V <sub>DD</sub> /2  | -   | 0   | ±250 | ps   |
| t <sub>7</sub>           | Device to Device Skew <sup>[7, 8]</sup>                                  | Measured at V <sub>DD</sub> /2 on the FBK pins of<br>devices              | -   | 0   | 700  | ps   |
| t <sub>8</sub>           | Output Slew Rate <sup>[7, 8]</sup>                                       | Measured between 0.8V and 2.0V on<br>-1H, -5H device using Test Circuit 2 | 1   | -   | -    | V/ns |
| t <sub>J</sub>           | Cycle to Cycle Jitter <sup>[7, 8]</sup><br>(-1, -1H, -4, -5H)            | Measured at 66.67 MHz, loaded<br>outputs, 15 pF load                      | -   | 75  | 200  | ps   |
|                          |  | Measured at 66.67 MHz, loaded<br>outputs, 30 pF load                      | -   | -   | 200  | ps   |
|                          |  | Measured at 133.3 MHz, loaded<br>outputs, 15 pF load                      | -   | -   | 100  | ps   |
| t <sub>J</sub>           | Cycle to Cycle Jitter <sup>[7, 8]</sup><br>(-2, -3)                      | Measured at 66.67 MHz, loaded<br>outputs<br>30 pF load                    | -   | -   | 400  | ps   |
|                          |  | Measured at 66.67 MHz, loaded<br>outputs<br>15 pF load                    | -   | -   | 400  | ps   |
| t <sub>LOCK</sub>        | PLL Lock Time <sup>[7, 8]</sup>  | Stable power supply, valid clocks<br>presented on REF and FBK pins        | -   | -   | 1.0  | ms   |

**Switching Waveforms**

**Figure 3. Duty Cycle Timing**

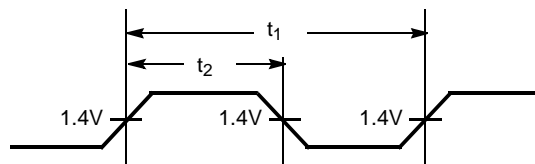

**Figure 4. All Outputs Rise/Fall Time**

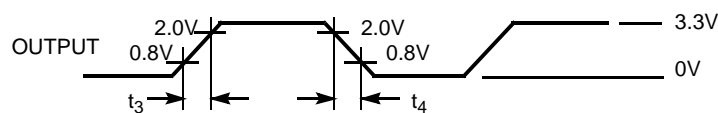

Switching Waveforms (continued)

Figure 5. Output-Output Skew

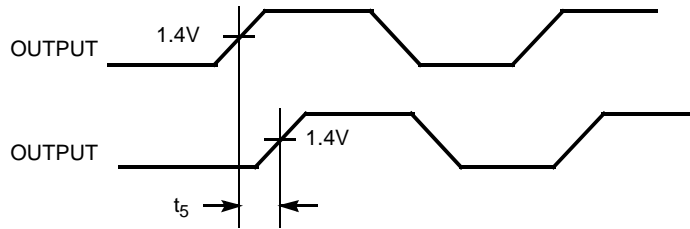

Figure 6. Input-Output Propagation Delay

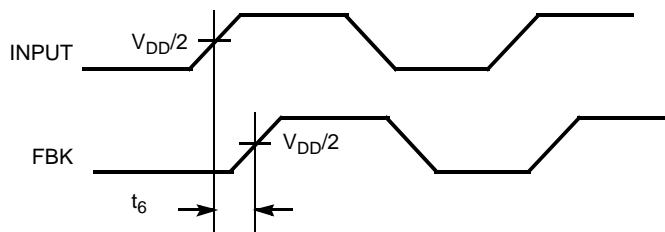
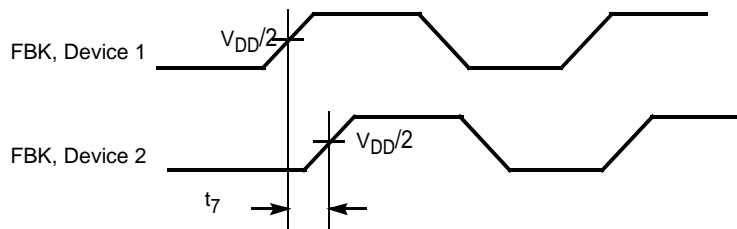
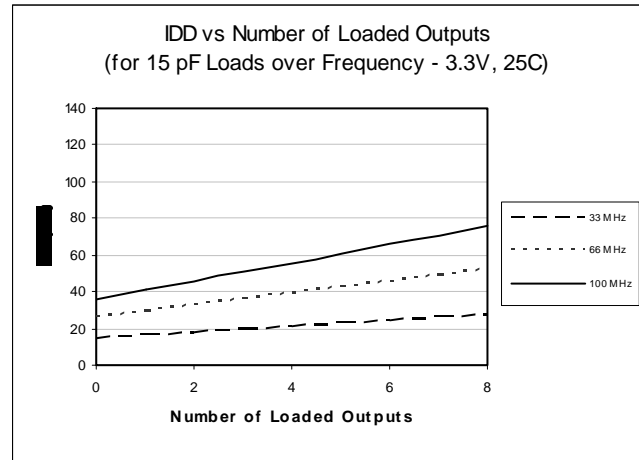
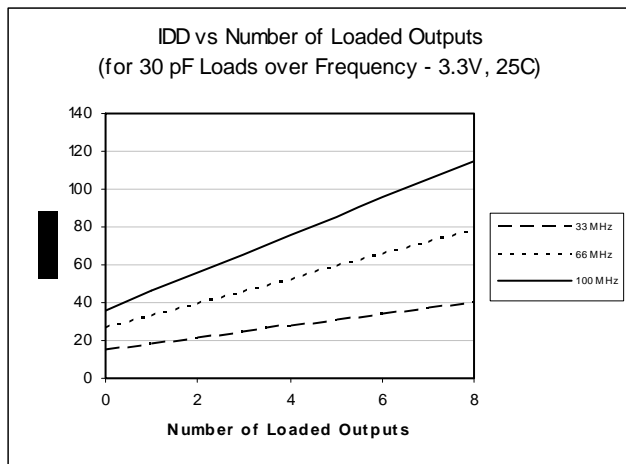
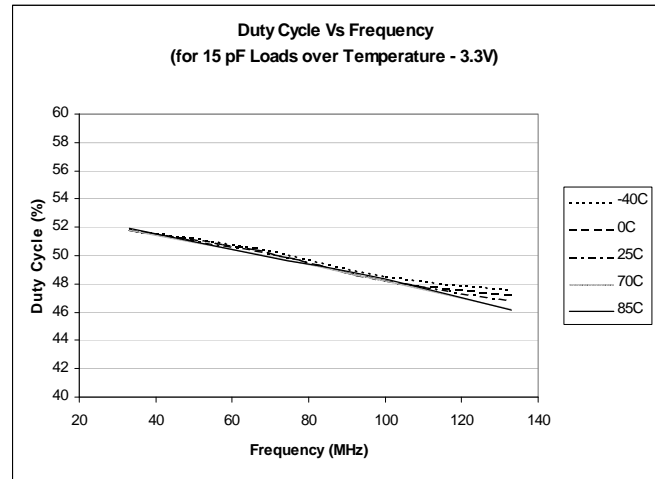
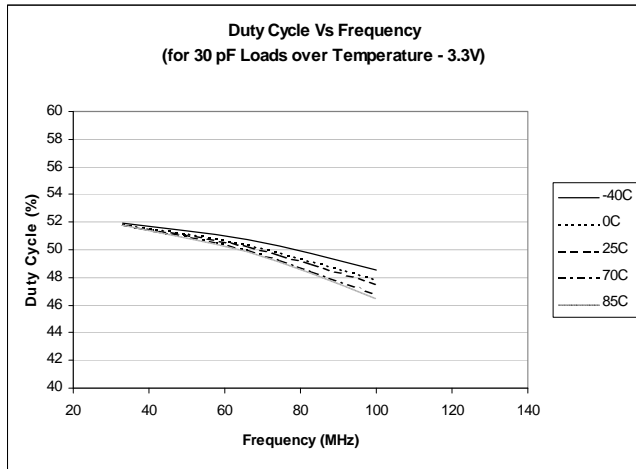
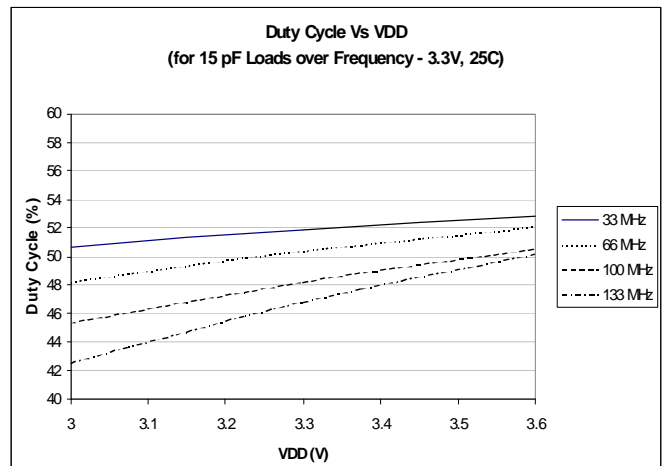
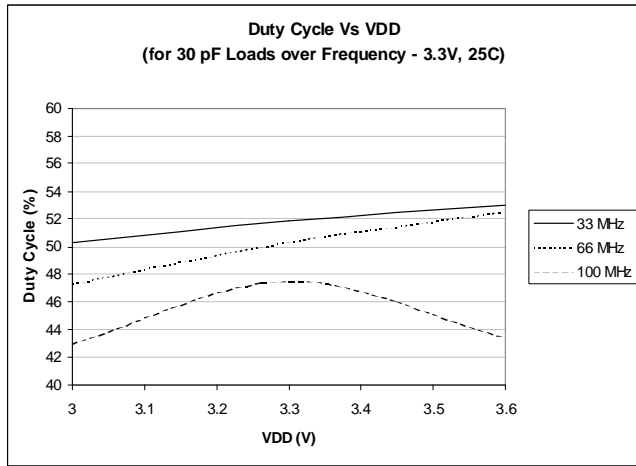

Figure 7. Device-Device Skew



Typical Duty Cycle<sup>[10]</sup> and I<sub>DD</sub> Trends<sup>[11]</sup> for CY2308-1,2,3,4



Notes

10. Duty cycle is taken from typical chip measured at 1.4V.

11. I<sub>DD</sub> data is calculated from  $I_{DD} = I_{CORE} + nCVf$ , where  $I_{CORE}$  is the unloaded current.  
 (n = number of outputs; C = Capacitance load per output (F); V = Voltage Supply (V); f = frequency (Hz)).

Typical Duty Cycle<sup>[10]</sup> and I<sub>DD</sub> Trends<sup>[11]</sup> for CY2308–1H, 5H

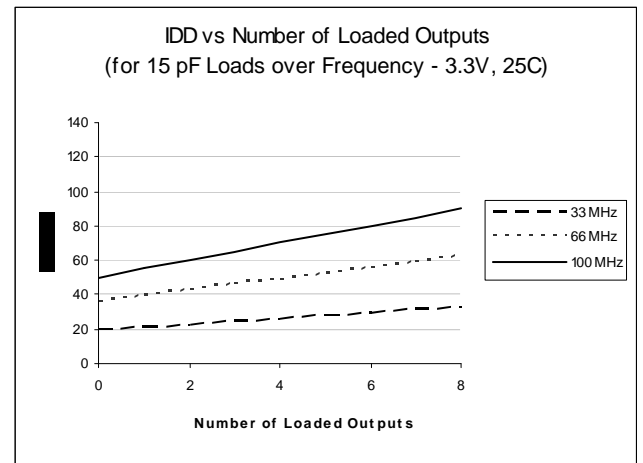
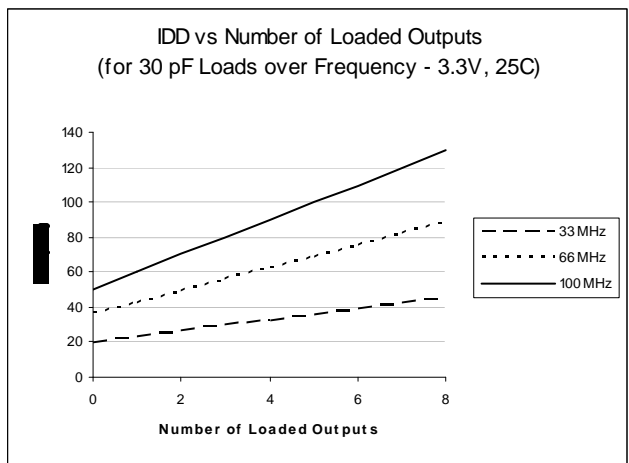
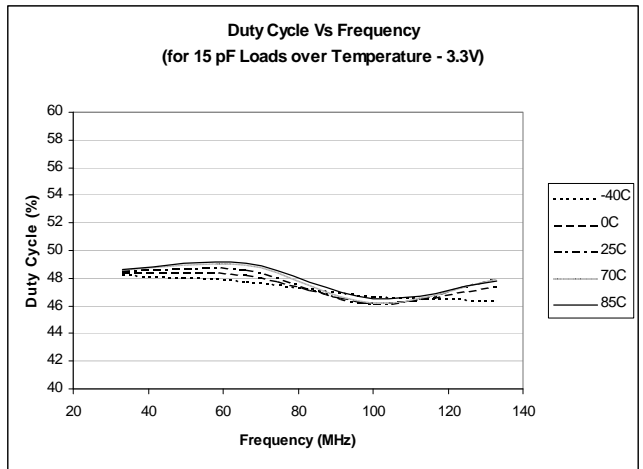
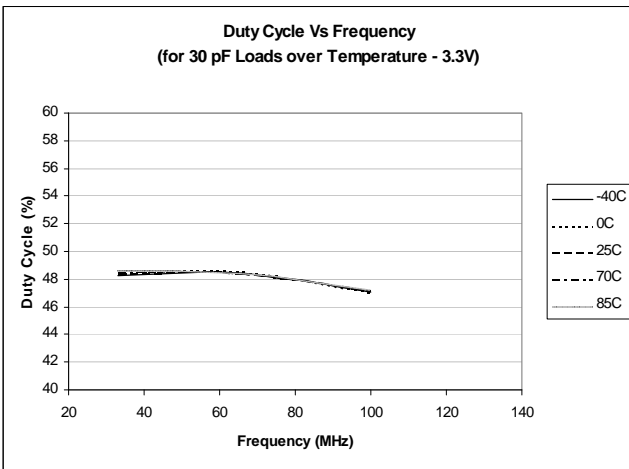
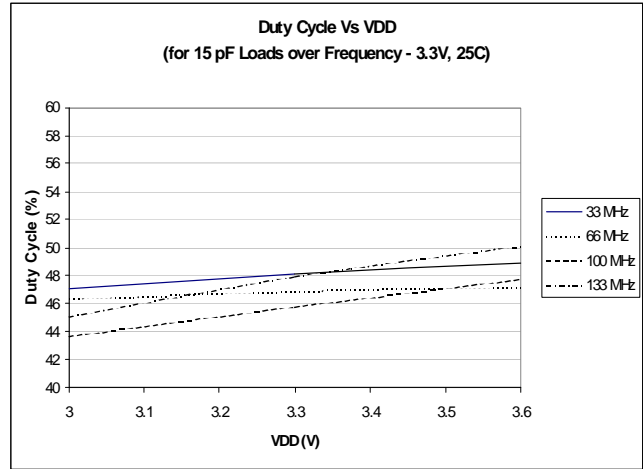
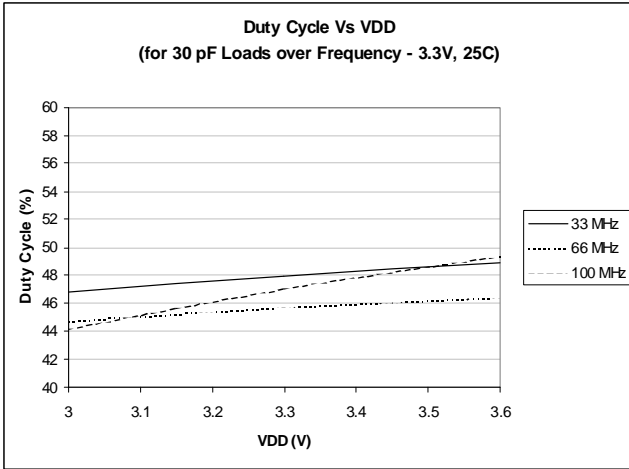

**Test Circuits**

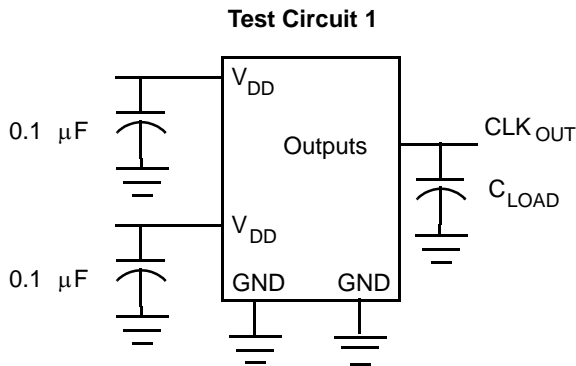

Test Circuit for all parameters except  $t_g$

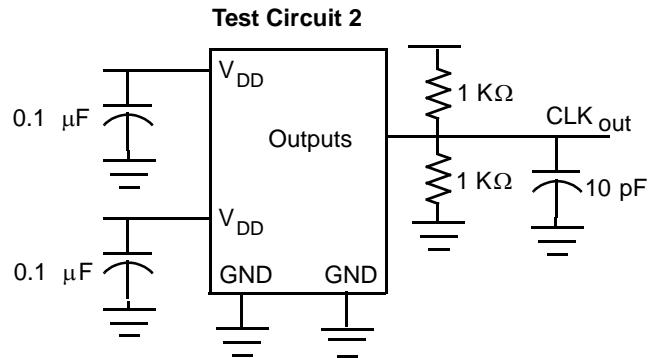

Test Circuit for  $t_g$ , Output slew rate on -1H, -5 device

**Ordering Information**

| Ordering Code                | Package Type                        | Operating Range |
|------------------------------|-------------------------------------|-----------------|
| CY2308SC-1 <sup>[12]</sup>   | 16-pin 150 mil SOIC                 | Commercial      |
| CY2308SC-1T <sup>[12]</sup>  | 16-pin 150 mil SOIC - Tape and Reel | Commercial      |
| CY2308SI-1 <sup>[12]</sup>   | 16-pin 150 mil SOIC                 | Industrial      |
| CY2308SI-1T <sup>[12]</sup>  | 16-pin 150 mil SOIC - Tape and Reel | Industrial      |
| CY2308SC-1H <sup>[12]</sup>  | 16-pin 150 mil SOIC                 | Commercial      |
| CY2308SC-1HT <sup>[12]</sup> | 16-pin 150 mil SOIC - Tape and Reel | Commercial      |
| CY2308SI-1H <sup>[12]</sup>  | 16-pin 150 mil SOIC                 | Industrial      |
| CY2308SI-1HT <sup>[12]</sup> | 16-pin 150 mil SOIC - Tape and Reel | Industrial      |
| CY2308ZC-1H <sup>[12]</sup>  | 16-pin 4.4mm TSSOP                  | Commercial      |
| CY2308ZC-1HT <sup>[12]</sup> | 16-pin 4.4mm TSSOP - Tape and Reel  | Commercial      |
| CY2308ZI-1H <sup>[12]</sup>  | 16-pin 4.4mm TSSOP                  | Industrial      |
| CY2308ZI-1HT <sup>[12]</sup> | 16-pin 4.4mm TSSOP - Tape and Reel  | Industrial      |
| CY2308SC-2 <sup>[12]</sup>   | 16-pin 150 mil SOIC                 | Commercial      |
| CY2308SC-2T <sup>[12]</sup>  | 16-pin 150 mil SOIC - Tape and Reel | Commercial      |
| CY2308SI-2 <sup>[12]</sup>   | 16-pin 150 mil SOIC                 | Industrial      |
| CY2308SI-2T <sup>[12]</sup>  | 16-pin 150 mil SOIC - Tape and Reel | Industrial      |
| CY2308SC-3 <sup>[12]</sup>   | 16-pin 150 mil SOIC                 | Commercial      |
| CY2308SC-3T <sup>[12]</sup>  | 16-pin 150 mil SOIC - Tape and Reel | Commercial      |
| CY2308SC-4 <sup>[12]</sup>   | 16-pin 150 mil SOIC                 | Commercial      |
| CY2308SC-4T <sup>[12]</sup>  | 16-pin 150 mil SOIC - Tape and Reel | Commercial      |

**Note**

12. Not recommended for new designs.

**Ordering Information** (continued)

| Ordering Code             | Package Type                        | Operating Range |
|---------------------------|-------------------------------------|-----------------|
| <b>Pb-Free</b>            |                                     |                 |
| CY2308SXC-1               | 16-pin 150 mil SOIC                 | Commercial      |
| CY2308SXC-1T              | 16-pin 150 mil SOIC - Tape and Reel | Commercial      |
| CY2308SXI-1               | 16-pin 150 mil SOIC                 | Industrial      |
| CY2308SXI-1T              | 16-pin 150 mil SOIC - Tape and Reel | Industrial      |
| CY2308SXC-1H              | 16-pin 150 mil SOIC                 | Commercial      |
| CY2308SXC-1HT             | 16-pin 150 mil SOIC - Tape and Reel | Commercial      |
| CY2308SXI-1H              | 16-pin 150 mil SOIC                 | Industrial      |
| CY2308SXI-1HT             | 16-pin 150 mil SOIC - Tape and Reel | Industrial      |
| CY2308ZXC-1H              | 16-pin 4.4mm TSSOP                  | Commercial      |
| CY2308ZXC-1HT             | 16-pin 4.4mm TSSOP - Tape and Reel  | Commercial      |
| CY2308ZXI-1H              | 16-pin 4.4mm TSSOP                  | Industrial      |
| CY2308ZXI-1HT             | 16-pin 4.4mm TSSOP - Tape and Reel  | Industrial      |
| CY2308SXC-2               | 16-pin 150 mil SOIC                 | Commercial      |
| CY2308SXC-2T              | 16-pin 150 mil SOIC - Tape and Reel | Commercial      |
| CY2308SXI-2               | 16-pin 150 mil SOIC                 | Industrial      |
| CY2308SXI-2T              | 16-pin 150 mil SOIC - Tape and Reel | Industrial      |
| CY2308SXC-3               | 16-pin 150 mil SOIC                 | Commercial      |
| CY2308SXC-3T              | 16-pin 150 mil SOIC - Tape and Reel | Commercial      |
| CY2308SXI-3               | 16-pin 150 mil SOIC                 | Industrial      |
| CY2308SXI-3T              | 16-pin 150 mil SOIC -Tape and Reel  | Industrial      |
| CY2308SXC-4               | 16-pin 150 mil SOIC                 | Commercial      |
| CY2308SXC-4T              | 16-pin 150 mil SOIC - Tape and Reel | Commercial      |
| CY2308SXI-4               | 16-pin 150 mil SOIC                 | Industrial      |
| CY2308SXI-4T              | 16-pin 150 mil SOIC - Tape and Reel | Industrial      |
| CY2308SXC-5H <sup>1</sup> | 16-pin 150 mil SOIC                 | Commercial      |
| CY2308SXC-5HT             | 16-pin 150 mil SOIC - Tape and Reel | Commercial      |
| CY2308SXI-5H              | 16-pin 150 mil SOIC                 | Industrial      |
| CY2308SXI-5HT             | 16-pin 150 mil SOIC - Tape and Reel | Industrial      |

Package Drawings and Dimensions

Figure 7. 16-Pin (150 Mil) SOIC S16.15

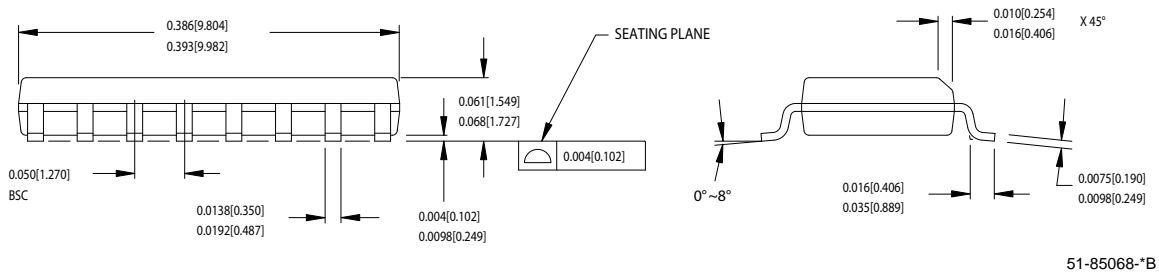
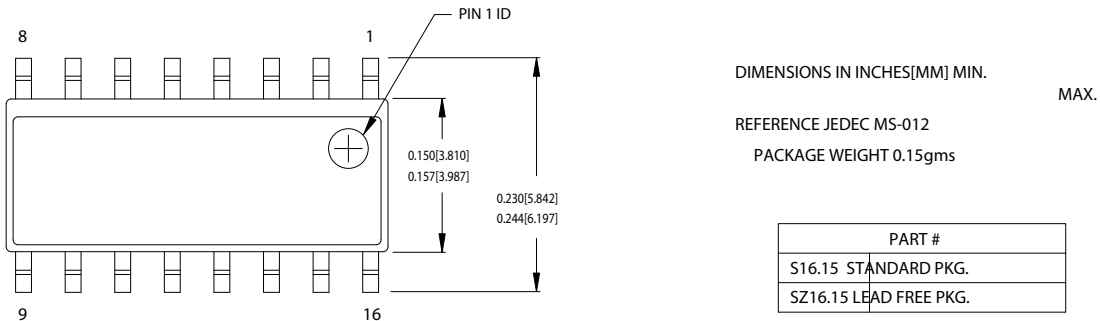
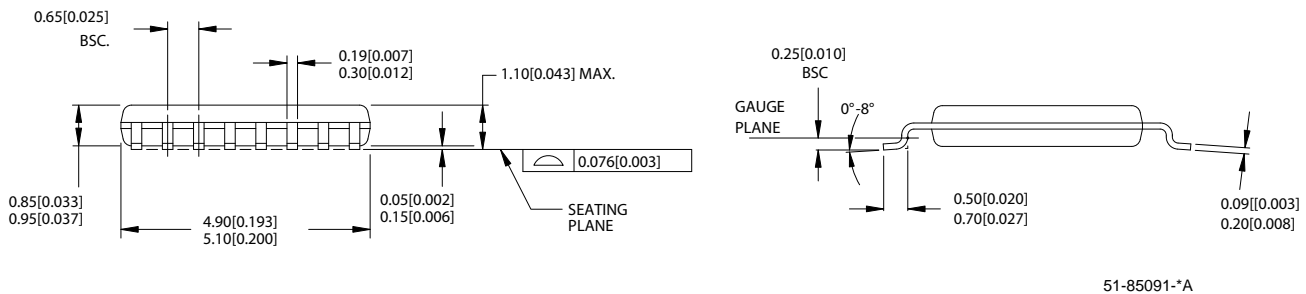
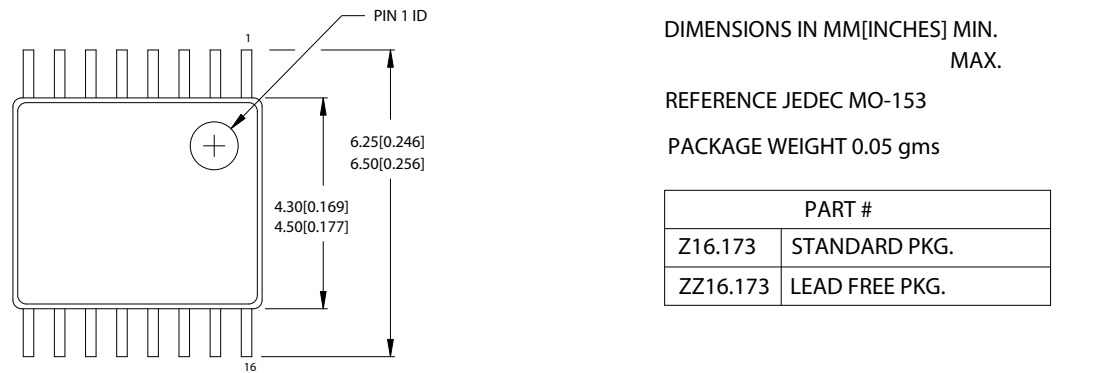

Figure 8. 16-Pin TSSOP 4.40 mm Body Z16.173



Document History Page

| Document Title: CY2308 3.3V Zero Delay Buffer<br>Document Number: 38-07146 |         |                 |                 |   |
|--|---------|-----------------|-----------------|---|
| Rev.   | ECN     | Orig. of Change | Submission Date | Description of Change   |
| **   | 110255  | SZV             | 12/17/01        | Changed from Specification number: 38-00528 to 38-07146   |
| *A   | 118722  | RGL             | 10/31/02        | Added Note 1 in page 2.   |
| *B   | 121832  | RBI             | 12/14/02        | Power up requirements added to Operating Conditions Information   |
| *C   | 235854  | RGL             | 06/24/04        | Added Pb-Free Devices   |
| *D   | 310594  | RGL             | 02/09/05        | Removed obsolete parts in the ordering information table<br>Specified typical value for cycle-to-cycle jitter   |
| *E   | 1344343 | KVM/VED         | 08/20/07        | Brought the Ordering Information Table up to date: removed three obsolete parts and added two parts<br>Changed titles to tables that are specific to commercial and industrial temperature ranges   |
| *F   | 2568575 | AESA            | 09/19/08        | Updated template. Added Note "Not recommended for new designs."<br>Changed IDD (PD mode) from 12.0 to 25.0 $\mu$ A for Commercial and Industrial Temperature Devices<br>Deleted Duty Cycle parameters for $F_{out} < 50$ MHz<br>Removed CY2308SI-4, CY2308SI-4T and CY2308SC-5HT. |
| *G   | 2632364 | KVM             | 01/08/09        | Corrected TSSOP package size (from 150 mil to 4.4 mm) in Ordering Information table   |
| *H   | 2673353 | KVM/PYRS        | 03/13/09        | Reverted IDD (PD mode) and Duty Cycle parameters back to the values in revision *E:<br>Changed IDD (PD mode) from 25 to 12 $\mu$ A for commercial temperature devices<br>Added Duty Cycle parameters for $F_{out} < 50$ MHz for commercial and industrial devices.                |

## Sales, Solutions, and Legal Information

### Worldwide Sales and Design Support

Cypress maintains a worldwide network of offices, solution centers, manufacturer's representatives, and distributors. To find the office closest to you, visit us at [cypress.com/sales](http://cypress.com/sales).

#### Products

|                  |  |
|------------------|--|
| PSoC             | <a href="http://psoc.cypress.com">psoc.cypress.com</a>         |
| Clocks & Buffers | <a href="http://clocks.cypress.com">clocks.cypress.com</a>     |
| Wireless         | <a href="http://wireless.cypress.com">wireless.cypress.com</a> |
| Memories         | <a href="http://memory.cypress.com">memory.cypress.com</a>     |
| Image Sensors    | <a href="http://image.cypress.com">image.cypress.com</a>       |

#### PSoC Solutions

|                       |  |
|-----------------------|--|
| General               | <a href="http://psoc.cypress.com/solutions">psoc.cypress.com/solutions</a>               |
| Low Power/Low Voltage | <a href="http://psoc.cypress.com/low-power">psoc.cypress.com/low-power</a>               |
| Precision Analog      | <a href="http://psoc.cypress.com/precision-analog">psoc.cypress.com/precision-analog</a> |
| LCD Drive             | <a href="http://psoc.cypress.com/lcd-drive">psoc.cypress.com/lcd-drive</a>               |
| CAN 2.0b              | <a href="http://psoc.cypress.com/can">psoc.cypress.com/can</a>                           |
| USB                   | <a href="http://psoc.cypress.com/usb">psoc.cypress.com/usb</a>                           |

---

© Cypress Semiconductor Corporation, 2001-2009. The information contained herein is subject to change without notice. Cypress Semiconductor Corporation assumes no responsibility for the use of any circuitry other than circuitry embodied in a Cypress product. Nor does it convey or imply any license under patent or other rights. Cypress products are not warranted nor intended to be used for medical, life support, life saving, critical control or safety applications, unless pursuant to an express written agreement with Cypress. Furthermore, Cypress does not authorize its products for use as critical components in life-support systems where a malfunction or failure may reasonably be expected to result in significant injury to the user. The inclusion of Cypress products in life-support systems application implies that the manufacturer assumes all risk of such use and in doing so indemnifies Cypress against all charges.



Any Source Code (software and/or firmware) is owned by Cypress Semiconductor Corporation (Cypress) and is protected by and subject to worldwide patent protection (United States and foreign), United States copyright laws and international treaty provisions. Cypress hereby grants to licensee a personal, non-exclusive, non-transferable license to copy, use, modify, create derivative works of, and compile the Cypress Source Code and derivative works for the sole purpose of creating custom software and or firmware in support of licensee product to be used only in conjunction with a Cypress integrated circuit as specified in the applicable agreement. Any reproduction, modification, translation, compilation, or representation of this Source Code except as specified above is prohibited without the express written permission of Cypress.

Disclaimer: CYPRESS MAKES NO WARRANTY OF ANY KIND, EXPRESS OR IMPLIED, WITH REGARD TO THIS MATERIAL, INCLUDING, BUT NOT LIMITED TO, THE IMPLIED WARRANTIES OF MERCHANTABILITY AND FITNESS FOR A PARTICULAR PURPOSE. Cypress reserves the right to make changes without further notice to the materials described herein. Cypress does not assume any liability arising out of the application or use of any product or circuit described herein. Cypress does not authorize its products for use as critical components in life-support systems where a malfunction or failure may reasonably be expected to result in significant injury to the user. The inclusion of Cypress' product in a life-support systems application implies that the manufacturer assumes all risk of such use and in doing so indemnifies Cypress against all charges.

Use may be limited by and subject to the applicable Cypress software license agreement.

## Looking for pricing, stock, or lifecycle information?

Click below to explore more details on WIN SOURCE:

-  [View CY2308SXI-5H on WIN SOURCE](#)
-  [Cypress Semiconductor Corp](#) Information

## Optimize Your Supply Chain with WIN SOURCE Solutions

-  Global Sourcing Solution
-  Obsolete Management
-  Cost Control Management
-  Shortage Management
-  Alternative Solution
-  Excess Inventory Management