



**THE DATASHEET OF  
NCP1400ASN50T1**



# ON Semiconductor

## Is Now

The logo for onsemi, featuring the word "onsemi" in a dark teal, lowercase, sans-serif font. The letter "i" is stylized with a white dot and a teal vertical bar. A small orange triangle is positioned above the top right of the "i". A trademark symbol (TM) is located to the right of the logo.

To learn more about onsemi™, please visit our website at  
[www.onsemi.com](http://www.onsemi.com)

---

**onsemi** and **onsemi** and other names, marks, and brands are registered and/or common law trademarks of Semiconductor Components Industries, LLC dba "**onsemi**" or its affiliates and/or subsidiaries in the United States and/or other countries. **onsemi** owns the rights to a number of patents, trademarks, copyrights, trade secrets, and other intellectual property. A listing of **onsemi** product/patent coverage may be accessed at [www.onsemi.com/site/pdf/Patent-Marking.pdf](http://www.onsemi.com/site/pdf/Patent-Marking.pdf). **onsemi** reserves the right to make changes at any time to any products or information herein, without notice. The information herein is provided "as-is" and **onsemi** makes no warranty, representation or guarantee regarding the accuracy of the information, product features, availability, functionality, or suitability of its products for any particular purpose, nor does **onsemi** assume any liability arising out of the application or use of any product or circuit, and specifically disclaims any and all liability, including without limitation special, consequential or incidental damages. Buyer is responsible for its products and applications using **onsemi** products, including compliance with all laws, regulations and safety requirements or standards, regardless of any support or applications information provided by **onsemi**. "Typical" parameters which may be provided in **onsemi** data sheets and/or specifications can and do vary in different applications and actual performance may vary over time. All operating parameters, including "Typicals" must be validated for each customer application by customer's technical experts. **onsemi** does not convey any license under any of its intellectual property rights nor the rights of others. **onsemi** products are not designed, intended, or authorized for use as a critical component in life support systems or any FDA Class 3 medical devices or medical devices with a same or similar classification in a foreign jurisdiction or any devices intended for implantation in the human body. Should Buyer purchase or use **onsemi** products for any such unintended or unauthorized application, Buyer shall indemnify and hold **onsemi** and its officers, employees, subsidiaries, affiliates, and distributors harmless against all claims, costs, damages, and expenses, and reasonable attorney fees arising out of, directly or indirectly, any claim of personal injury or death associated with such unintended or unauthorized use, even if such claim alleges that **onsemi** was negligent regarding the design or manufacture of the part. **onsemi** is an Equal Opportunity/Affirmative Action Employer. This literature is subject to all applicable copyright laws and is not for resale in any manner. Other names and brands may be claimed as the property of others.

# NCP1400A

## 100 mA, Fixed Frequency PWM Step-Up Micropower Switching Regulator

The NCP1400A series are micropower step-up DC to DC converters that are specifically designed for powering portable equipment from one or two cell battery packs. These devices are designed to startup with a cell voltage of 0.8 V and operate down to less than 0.2 V. With only four external components, this series allows a simple means to implement highly efficient converters that are capable of up to 100 mA of output current.

Each device consists of an on-chip fixed frequency oscillator, pulse width modulation controller, phase compensated error amplifier that ensures converter stability with discontinuous mode operation, soft-start, voltage reference, driver, and power MOSFET switch with current limit protection. Additionally, a chip enable feature is provided to power down the converter for extended battery life.

The NCP1400A device series are available in the TSOP-5 package with seven standard regulated output voltages. Additional voltages that range from 1.8 V to 4.9 V in 100 mV steps can be manufactured.

### Features

- Extremely Low Startup Voltage of 0.8 V
- Operation Down to Less than 0.2 V
- Only Four External Components for Simple Highly Efficient Converters
- Up to 100 mA Output Current Capability
- Fixed Frequency Pulse Width Modulation Operation
- Phase Compensated Error Amplifier for Stable Converter Operation
- Chip Enable Power Down Capability for Extended Battery Life
- These Devices are Pb-Free and are RoHS Compliant

### Typical Applications

- Cellular Telephones
- Pagers
- Personal Digital Assistants
- Electronic Games
- Digital Cameras
- Camcorders
- Handheld Instruments
- White LED Torch Light



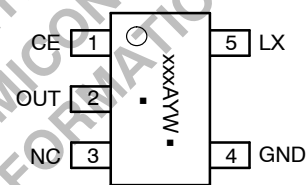
ON Semiconductor®

[www.onsemi.com](http://www.onsemi.com)



TSOP-5  
SN SUFFIX  
CASE 483

### PIN CONNECTIONS AND MARKING DIAGRAM



(Top View)

xxx = Marking  
A = Assembly Location  
Y = Year  
W = Work Week  
▪ = Pb-Free Package

(Note: Microdot may be in either location)

### ORDERING INFORMATION

See detailed ordering and shipping information in the ordering information section on page 2 of this data sheet.

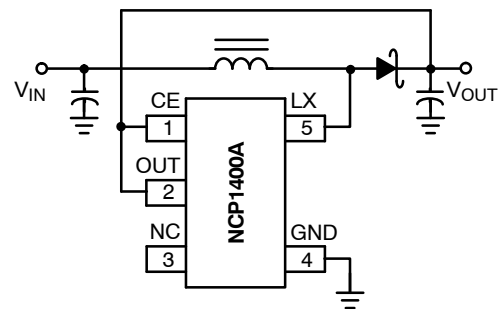


Figure 1. Typical Step-Up Converter Application

# NCP1400A

## ORDERING INFORMATION

Device	Output Voltage	Switching Frequency	Marking	Package	Shipping†
NCP1400ASN19T1G	1.9 V	180 KHz	DAI	TSOP-5 (Pb-Free)	3000 / Tape & Reel (7 Inch Reel)
NCP1400ASN22T1G	2.2 V		DCN		
NCP1400ASN25T1G	2.5 V		DAV		
NCP1400ASN27T1G	2.7 V		DAA		
NCP1400ASN30T1G	3.0 V		DAB		
NCP1400ASN33T1G	3.3 V		DAJ		
NCP1400ASN38T1G	3.8 V		DBK		
NCP1400ASN45T1G	4.5 V		DBL		
NCP1400ASN50T1G	5.0 V		DAD		

NOTE: The ordering information lists seven standard output voltage device options. Additional devices with output voltage ranging from 1.8 V to 5.0 V in 100 mV increments can be manufactured. Contact your ON Semiconductor representative for availability.

†For information on tape and reel specifications, including part orientation and tape sizes, please refer to our Tape and Reel Packaging Specifications Brochure, BRD8011/D.

**OBSOLETE**  
THIS DEVICE IS OBSOLETE  
PLEASE CONTACT YOUR ON SEMICONDUCTOR  
REPRESENTATIVE FOR INFORMATION

# NCP1400A

## ABSOLUTE MAXIMUM RATINGS

Rating	Symbol	Value	Unit
Power Supply Voltage (Pin 2)	$V_{OUT}$	-0.3 to 6.0	V
Input/Output Pins LX (Pin 5) LX Peak Sink Current	$V_{LX}$ $I_{LX}$	-0.3 to 6.0 400	V mA
CE (Pin 1) Input Voltage Range Input Current Range	$V_{CE}$ $I_{CE}$	-0.3 to 6.0 -150 to 150	V mA
Thermal Resistance Junction to Air	$R_{\theta JA}$	250	°C/W
Operating Ambient Temperature Range (Note 2)	$T_A$	-40 to +85	°C
Operating Junction Temperature Range	$T_J$	-40 to +125	°C
Storage Temperature Range	$T_{stg}$	-55 to +150	°C

Stresses exceeding those listed in the Maximum Ratings table may damage the device. If any of these limits are exceeded, device functionality should not be assumed, damage may occur and reliability may be affected.

- This device series contains ESD protection and exceeds the following tests:  
Human Body Model (HBM)  $\pm 2.0$  kV per JEDEC standard: JESD22-A114.  
Machine Model (MM)  $\pm 150$  V per JEDEC standard: JESD22-A115.
- The maximum package power dissipation limit must not be exceeded.

$$P_D = \frac{T_{J(max)} - T_A}{R_{\theta JA}}$$

- Latchup Current Maximum Rating:  $\pm 150$  mA per JEDEC standard: JESD78.
- Moisture Sensitivity Level (MSL): 1 per IPC/JEDEC standard: J-STD-020A.

## ELECTRICAL CHARACTERISTICS (For all values $T_A = 25^\circ\text{C}$ , unless otherwise noted.)

Characteristic	Symbol	Min	Typ	Max	Unit
<b>OSCILLATOR</b>					
Frequency ( $V_{OUT} = V_{SET} \times 0.96$ , Note 5)	$f_{OSC}$	144	180	216	kHz
Frequency Temperature Coefficient ( $T_A = -40^\circ\text{C}$ to $85^\circ\text{C}$ )	$\Delta f$	-	0.11	-	%/°C
Maximum PWM Duty Cycle ( $V_{OUT} = V_{SET} \times 0.96$ )	$D_{MAX}$	68	75	82	%
Minimum Startup Voltage ( $I_O = 0$ mA)	$V_{start}$	-	0.8	0.95	V
Minimum Startup Voltage Temperature Coefficient ( $T_A = -40^\circ\text{C}$ to $85^\circ\text{C}$ )	$\Delta V_{start}$	-	-1.6	-	mV/°C
Minimum Operation Hold Voltage ( $I_O = 0$ mA)	$V_{hold}$	0.3	-	-	V
Soft-Start Time ( $V_{OUT} > 0.8$ V)	$t_{SS}$	0.5	2.0	-	ms

## LX (PIN 5)

LX Pin On-State Sink Current ( $V_{LX} = 0.4$ V) Device Suffix:	$I_{LX}$				mA
19T1		80	90	-	
22T1		80	90	-	
25T1		80	120	-	
27T1		100	125	-	
30T1		100	130	-	
33T1		100	135	-	
38T1		100	145	-	
45T1		100	155	-	
50T1		100	160	-	
Voltage Limit ( $V_{OUT} = V_{CE} = V_{SET} \times 0.96$ , $V_{LX}$ "L" Side)	$V_{LXLIM}$	0.65	0.8	1.0	V
Off-State Leakage Current ( $V_{LX} = 5.0$ V, $T_A = -40^\circ\text{C}$ to $85^\circ\text{C}$ )	$I_{LKG}$	-	0.5	1.0	$\mu\text{A}$

- $V_{SET}$  means setting of output voltage.
- CE pin is integrated with an internal 150 nA pullup current source.

# NCP1400A

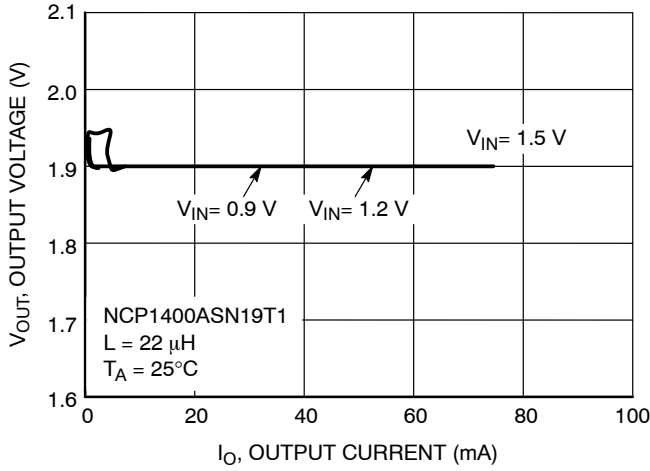
## ELECTRICAL CHARACTERISTICS (continued) (For all values $T_A = 25^\circ\text{C}$ , unless otherwise noted.)

Characteristic	Symbol	Min	Typ	Max	Unit
<b>CE (PIN 1)</b>					
CE Input Voltage ( $V_{OUT} = V_{SET} \times 0.96$ ) High State, Device Enabled Low State, Device Disabled	$V_{CE(high)}$ $V_{CE(low)}$	0.9 –	– –	– 0.3	V
CE Input Current (Note 6) High State, Device Enabled ( $V_{OUT} = V_{CE} = 5.0\text{ V}$ ) Low State, Device Disabled ( $V_{OUT} = 5.0\text{ V}$ , $V_{CE} = 0\text{ V}$ )	$I_{CE(high)}$ $I_{CE(low)}$	–0.5 –0.5	0 0.15	0.5 0.5	$\mu\text{A}$
<b>TOTAL DEVICE</b>					
Output Voltage ( $V_{IN} = 0.7 \times V_{OUT}$ , $I_O = 10\text{ mA}$ ) Device Suffix:	$V_{OUT}$				V
19T1		1.853	1.9	1.948	
22T1		2.145	2.2	2.255	
25T1		2.438	2.5	2.563	
27T1		2.633	2.7	2.768	
30T1		2.925	3.0	3.075	
33T1		3.218	3.3	3.383	
38T1		3.705	3.8	3.895	
45T1		4.3875	4.5	4.6125	
50T1		4.875	5.0	5.125	
Output Voltage Temperature Coefficient ( $T_A = -40^\circ\text{C}$ to $+85^\circ\text{C}$ ) Device Suffix:	$\Delta V_{OUT}$				ppm/ $^\circ\text{C}$
19T1		–	100	–	
22T1		–	100	–	
25T1		–	100	–	
27T1		–	100	–	
30T1		–	100	–	
33T1		–	100	–	
38T1		–	150	–	
45T1		–	150	–	
50T1		–	150	–	
Operating Current 2 ( $V_{OUT} = V_{CE} = V_{SET} + 0.5\text{ V}$ , Note 5)	$I_{DD2}$	–	7.0	15	$\mu\text{A}$
Off-State Current ( $V_{OUT} = 5.0\text{ V}$ , $V_{CE} = 0\text{ V}$ , $T_A = -40^\circ\text{C}$ to $+85^\circ\text{C}$ , Note 6)	$I_{OFF}$	–	0.6	1.5	$\mu\text{A}$
Operating Current 1 ( $V_{OUT} = V_{CE} = V_{SET} \times 0.96$ , $f_{OSC} = 180\text{ kHz}$ ) Device Suffix:	$I_{DD1}$				$\mu\text{A}$
19T1		–	23	50	
22T1		–	27	60	
25T1		–	32	60	
27T1		–	32	60	
30T1		–	37	60	
33T1		–	37	60	
38T1		–	44	65	
45T1		–	53	75	
50T1		–	70	100	

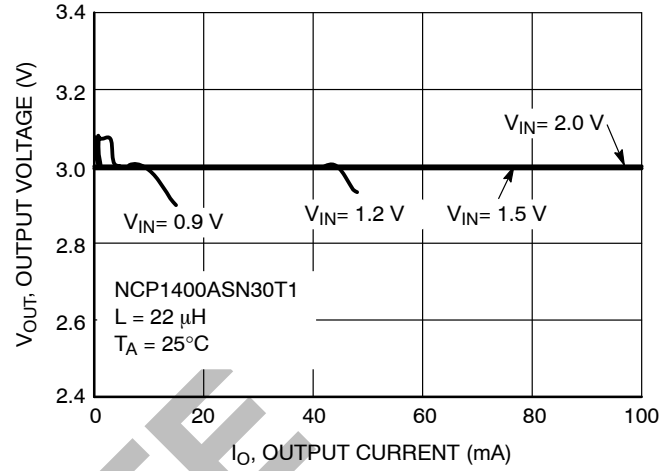
5.  $V_{SET}$  means setting of output voltage.

6. CE pin is integrated with an internal 150 nA pullup current source.

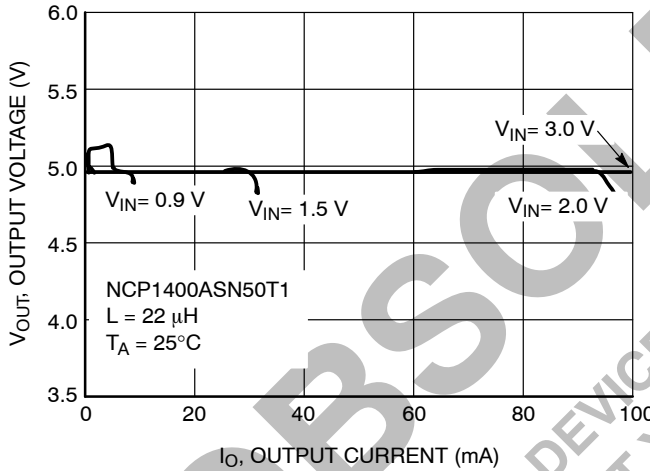
# NCP1400A



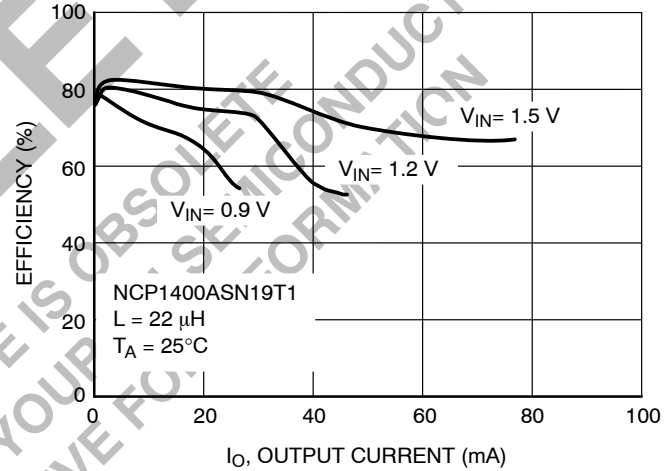
**Figure 2. NCP1400ASN19T1 Output Voltage vs. Output Current**



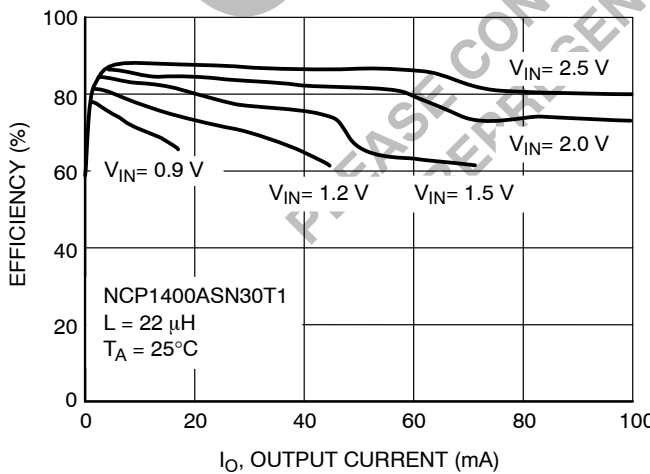
**Figure 3. NCP1400ASN30T1 Output Voltage vs. Output Current**



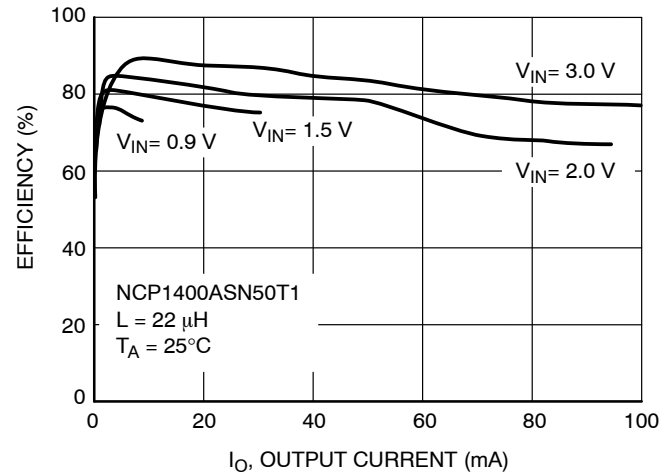
**Figure 4. NCP1400ASN50T1 Output Voltage vs. Output Current**



**Figure 5. NCP1400ASN19T1 Efficiency vs. Output Current**

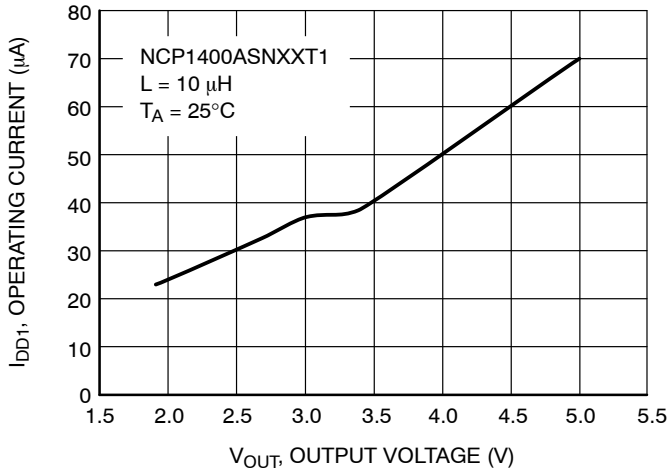


**Figure 6. NCP1400ASN30T1 Efficiency vs. Output Current**

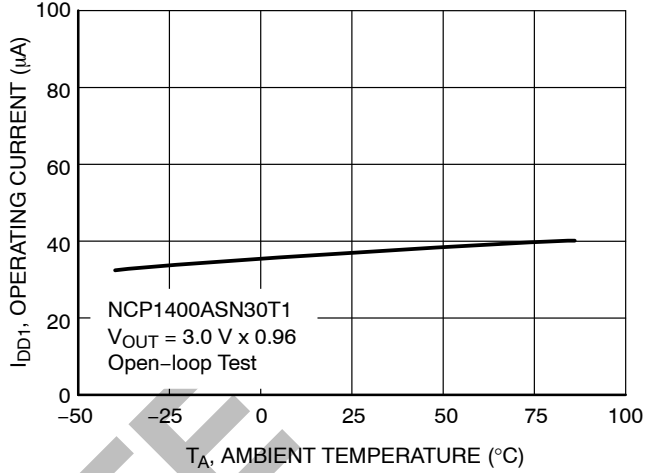


**Figure 7. NCP1400ASN50T1 Efficiency vs. Output Current**

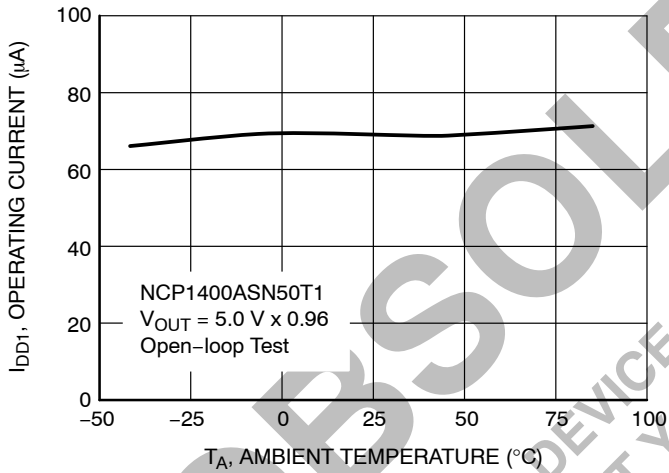
# NCP1400A



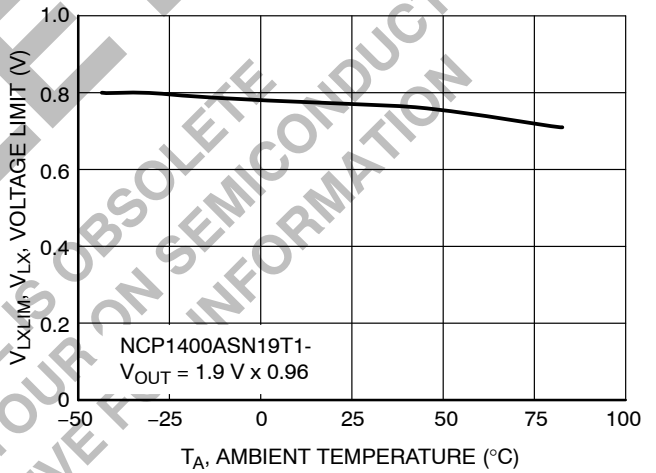
**Figure 8. NCP1400ASNXXT1 Operating Current ( $I_{DD1}$ ) vs. Output Voltage**



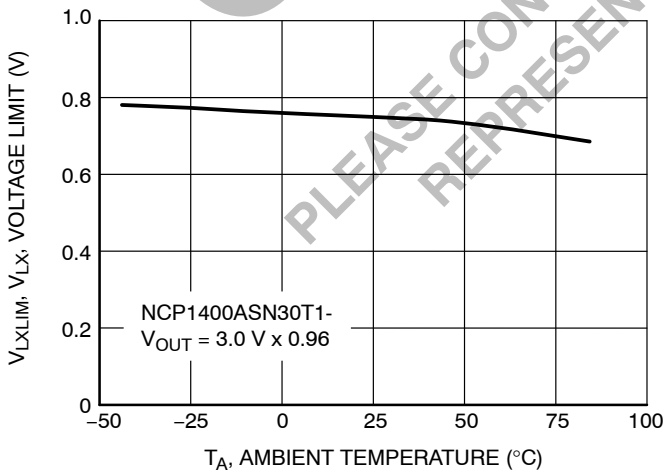
**Figure 9. NCP1400ASN30T1 Current Consumption vs. Temperature**



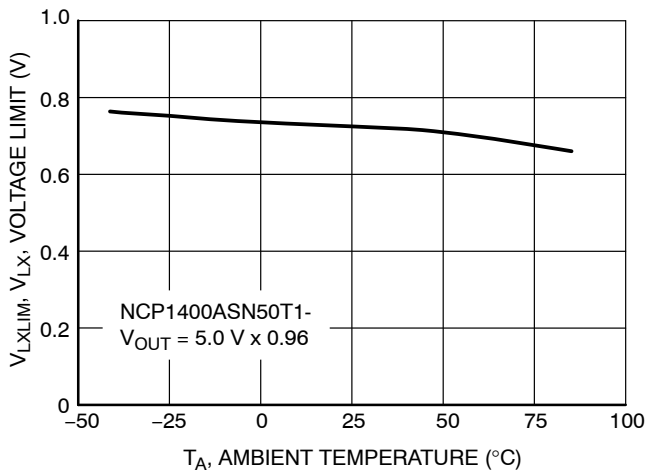
**Figure 10. NCP1400ASN50T1 Current Consumption vs. Temperature**



**Figure 11. NCP1400ASN19T1  $V_{LX}$  Voltage Limit vs. Temperature**



**Figure 12. NCP1400ASN30T1  $V_{LX}$  Voltage Limit vs. Temperature**



**Figure 13. NCP1400ASN50T1  $V_{LX}$  Voltage Limit vs. Temperature**

# NCP1400A

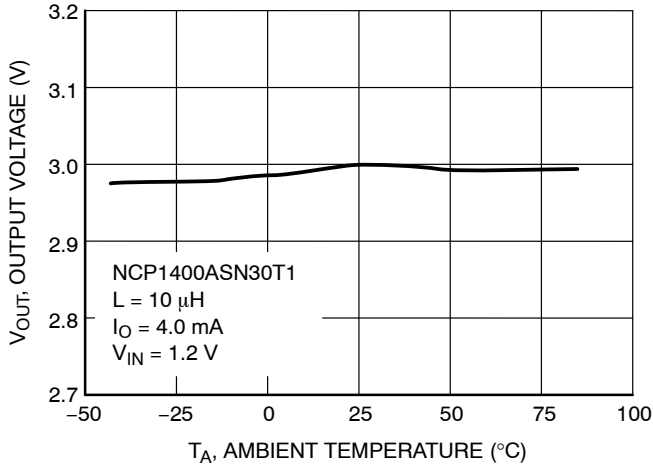


Figure 14. NCP1400ASN30T1 Output Voltage vs. Temperature

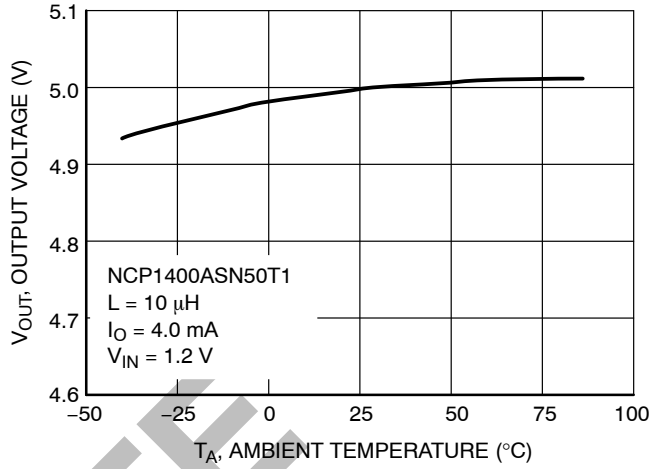


Figure 15. NCP1400ASN50T1 Output Voltage vs. Temperature

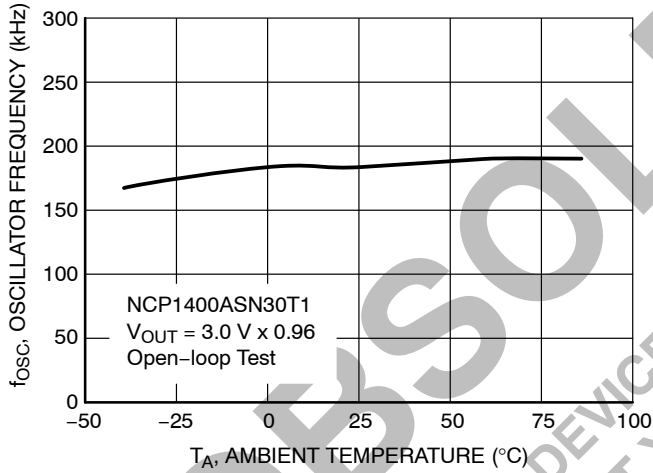


Figure 16. NCP1400ASN30T1 Oscillator Frequency vs. Temperature

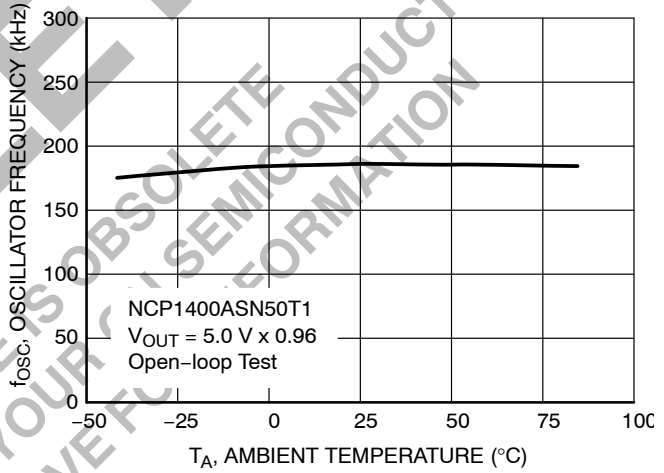


Figure 17. NCP1400ASN50T1 Oscillator Frequency vs. Temperature

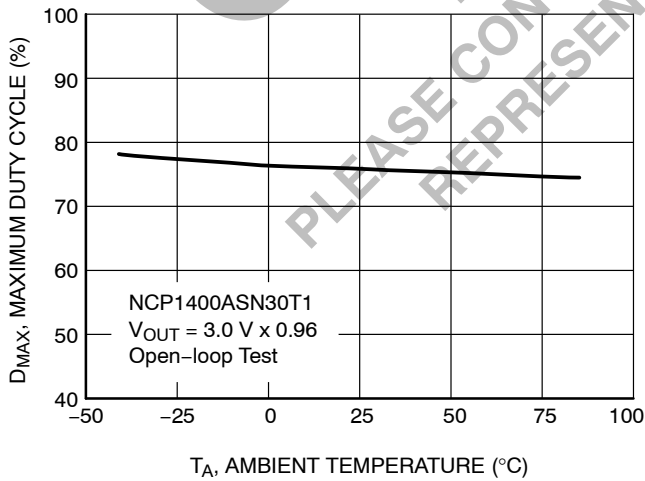


Figure 18. NCP1400ASN30T1 Maximum Duty Cycle vs. Temperature

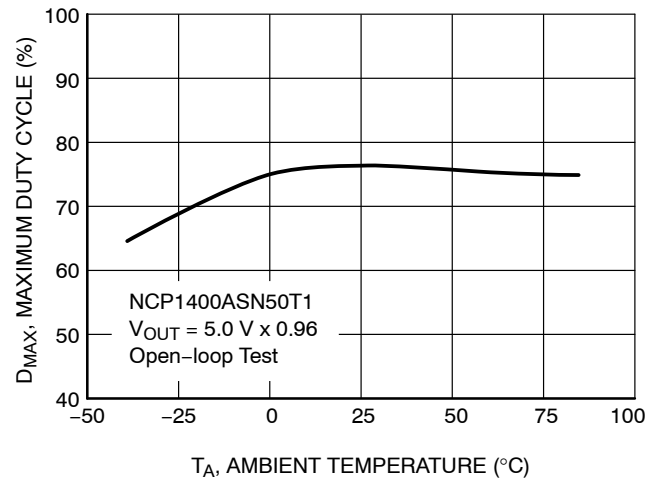


Figure 19. NCP1400ASN50T1 Maximum Duty Cycle vs. Temperature

# NCP1400A

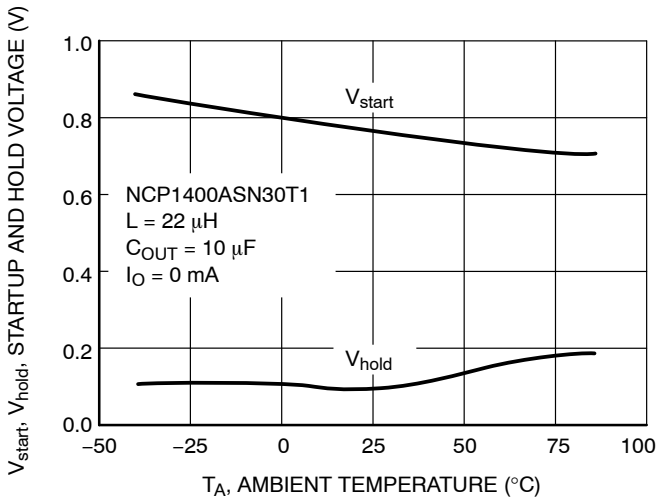


Figure 20. NCP1400ASN30T1 Startup/Hold Voltage vs. Temperature

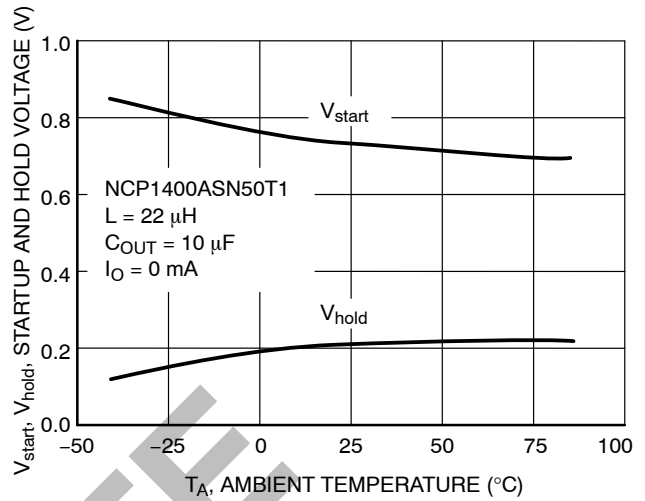


Figure 21. NCP1400ASN50T1 Startup/Hold Voltage vs. Temperature

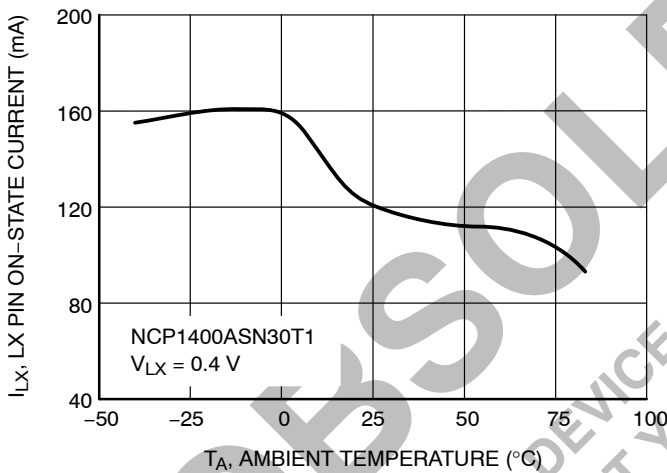


Figure 22. NCP1400ASN30T1 LX Pin On-State Current vs. Temperature

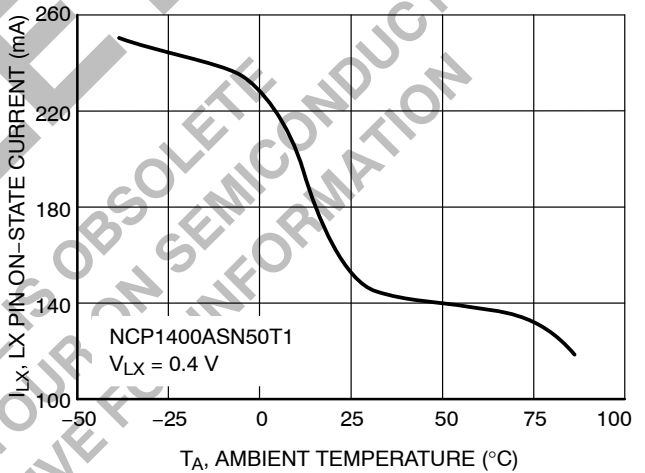


Figure 23. NCP1400ASN50T1 LX Pin On-State Current vs. Temperature

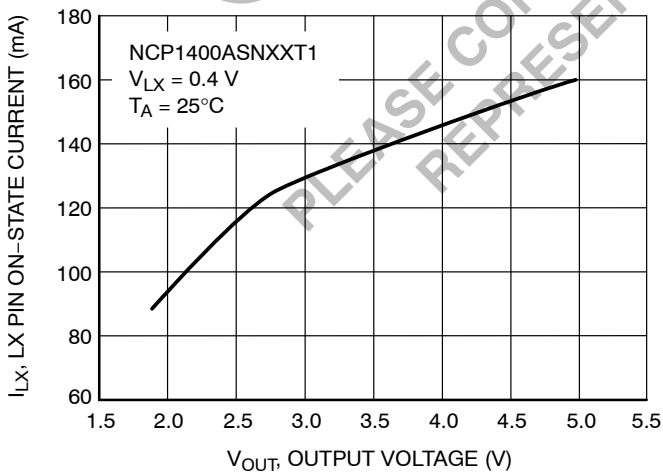


Figure 24. NCP1400ASNXXT1 LX Pin On-State Current vs. Output Voltage

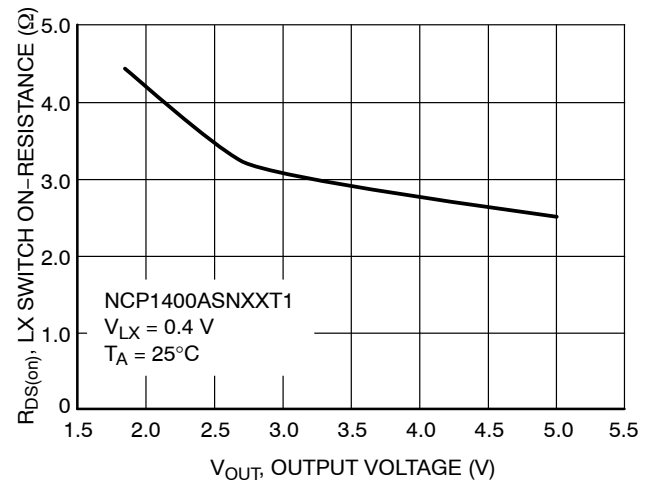
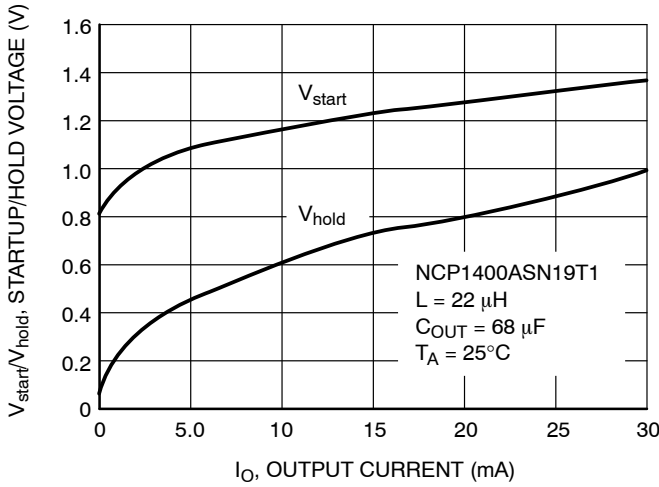
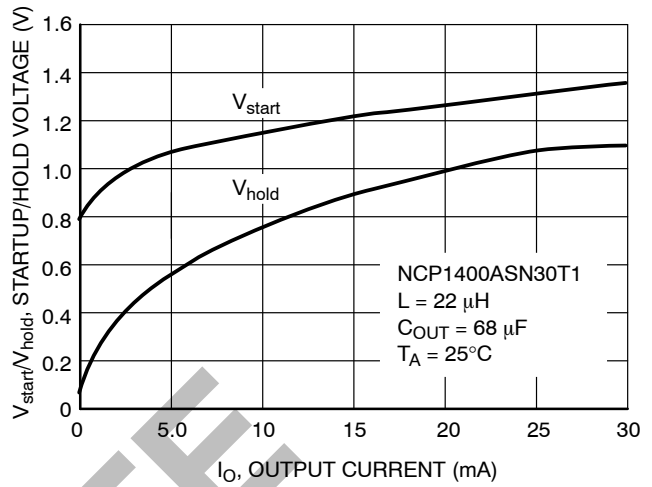


Figure 25. NCP1400ASNXXT1 LX Switch On-Resistance vs. Output Voltage

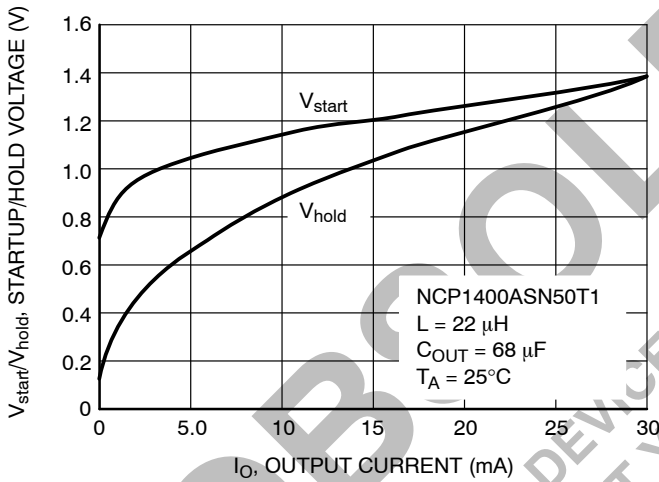
# NCP1400A



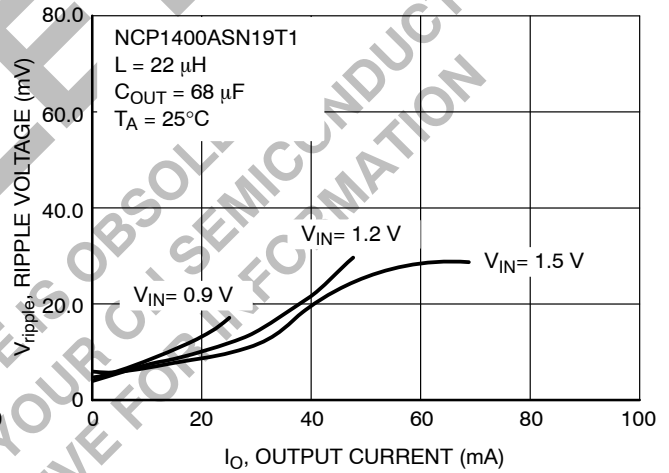
**Figure 26. NCP1400ASN19T1 Operation Startup/Hold Voltage vs. Output Current**



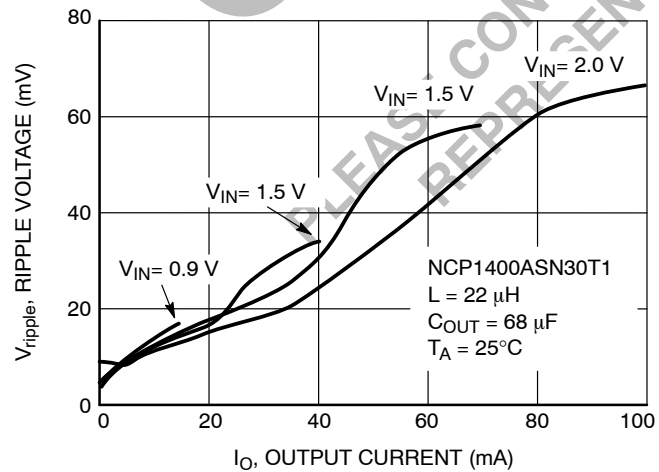
**Figure 27. NCP1400ASN30T1 Operation Startup/Hold Voltage vs. Output Current**



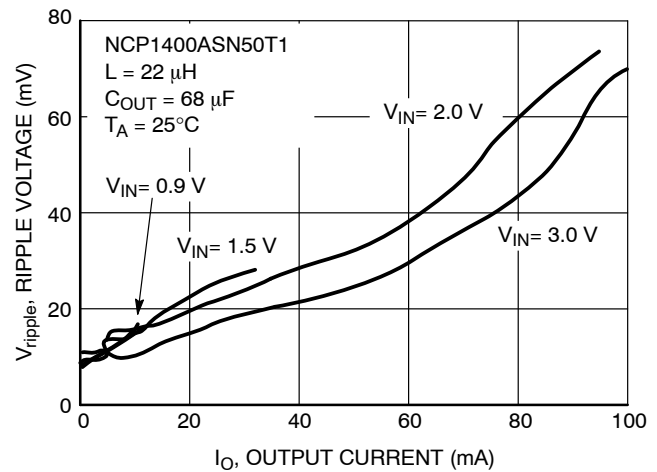
**Figure 28. NCP1400ASN50T1 Operation Startup/Hold Voltage vs. Output Current**



**Figure 29. NCP1400ASN19T1 Ripple Voltage vs. Output Current**

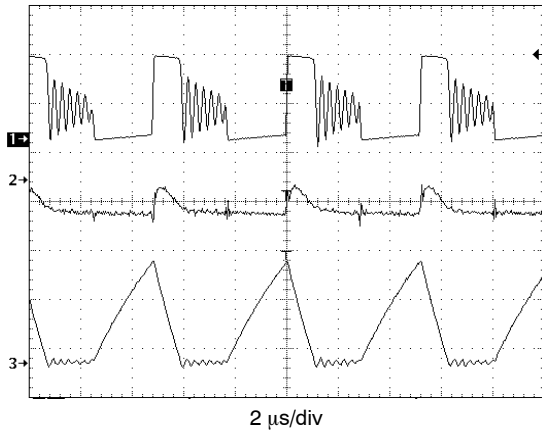


**Figure 30. NCP1400ASN30T1 Ripple Voltage vs. Output Current**



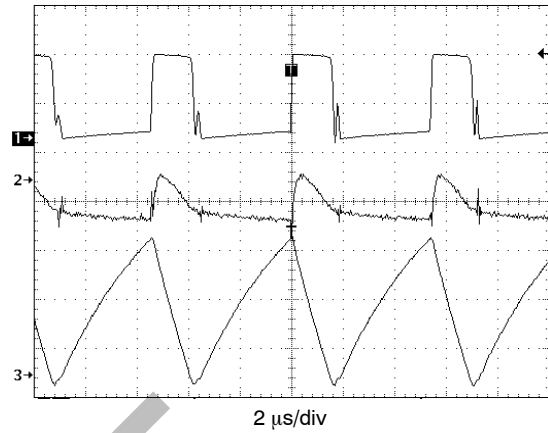
**Figure 31. NCP1400ASN50T1 Ripple Voltage vs. Output Current**

# NCP1400A



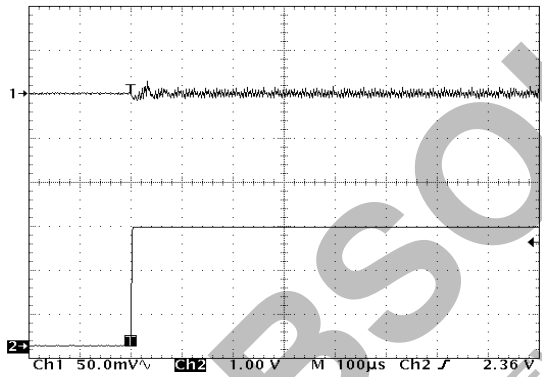
$V_{OUT} = 3.0\text{ V}$ ,  $V_{IN} = 1.2\text{ V}$ ,  $I_O = 10\text{ mA}$ ,  $L = 22\text{ }\mu\text{H}$ ,  $C_{OUT} = 68\text{ }\mu\text{F}$   
 1.  $V_{LX}$ , 2.0 V/div  
 2.  $V_{OUT}$ , 20 mV/div, AC coupled  
 3.  $I_L$ , 100 mA/div

**Figure 32. Operating Waveforms (Medium Load)**



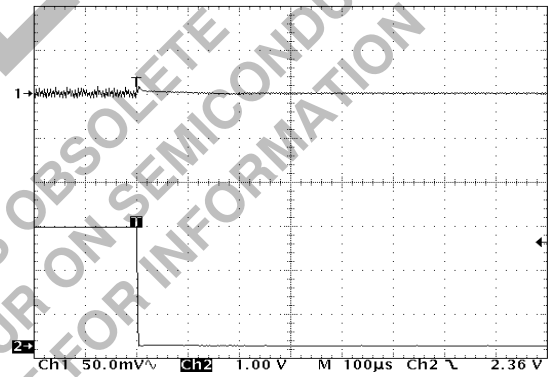
$V_{OUT} = 3.0\text{ V}$ ,  $V_{IN} = 1.2\text{ V}$ ,  $I_O = 25\text{ mA}$ ,  $L = 22\text{ }\mu\text{H}$ ,  $C_{OUT} = 68\text{ }\mu\text{F}$   
 1.  $V_{LX}$ , 2.0 V/div  
 2.  $V_{OUT}$ , 20 mV/div, AC coupled  
 3.  $I_L$ , 100 mA/div

**Figure 33. Operating Waveforms (Heavy Load)**



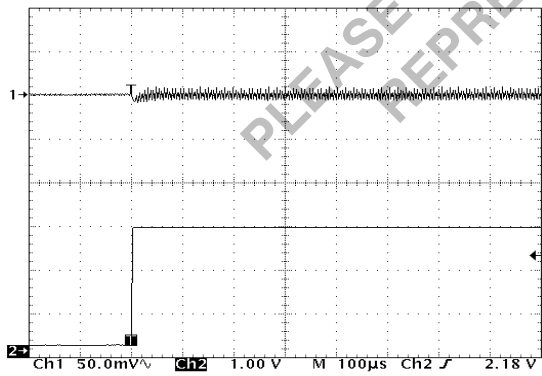
$V_{IN} = 1.2\text{ V}$ ,  $L = 22\text{ }\mu\text{H}$   
 1.  $V_{OUT} = 1.9\text{ V}$  (AC coupled), 50 mV/div  
 2.  $I_O = 3.0\text{ mA}$  to 30 mA

**Figure 34. NCP1400ASN19T1  
 Load Transient Response**



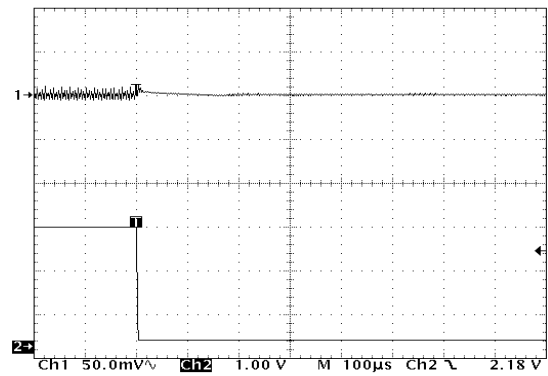
$V_{IN} = 1.2\text{ V}$ ,  $L = 22\text{ }\mu\text{H}$   
 1.  $V_{OUT} = 1.9\text{ V}$  (AC coupled), 50 mV/div  
 2.  $I_O = 30\text{ mA}$  to 3.0 mA

**Figure 35. NCP1400ASN19T1  
 Load Transient Response**



$V_{IN} = 1.5\text{ V}$ ,  $L = 22\text{ }\mu\text{H}$   
 1.  $V_{OUT} = 3.0\text{ V}$  (AC coupled), 50 mV/div  
 2.  $I_O = 3.0\text{ mA}$  to 30 mA

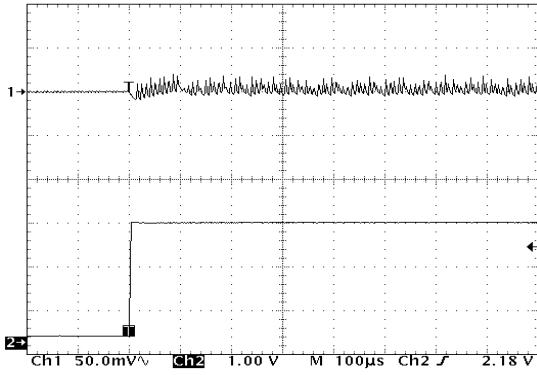
**Figure 36. NCP1400ASN30T1  
 Load Transient Response**



$V_{IN} = 1.5\text{ V}$ ,  $L = 22\text{ }\mu\text{H}$   
 1.  $V_{OUT} = 3.0\text{ V}$  (AC coupled), 50 mV/div  
 2.  $I_O = 30\text{ mA}$  to 3.0 mA

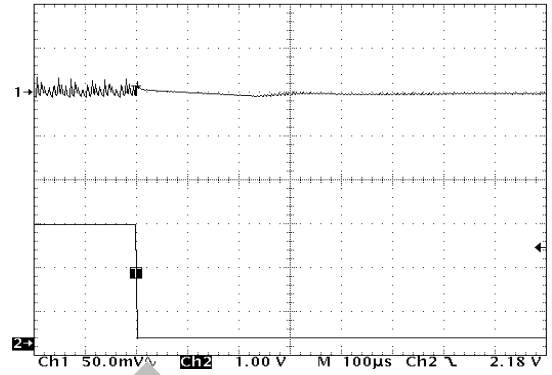
**Figure 37. NCP1400ASN30T1  
 Load Transient Response**

# NCP1400A



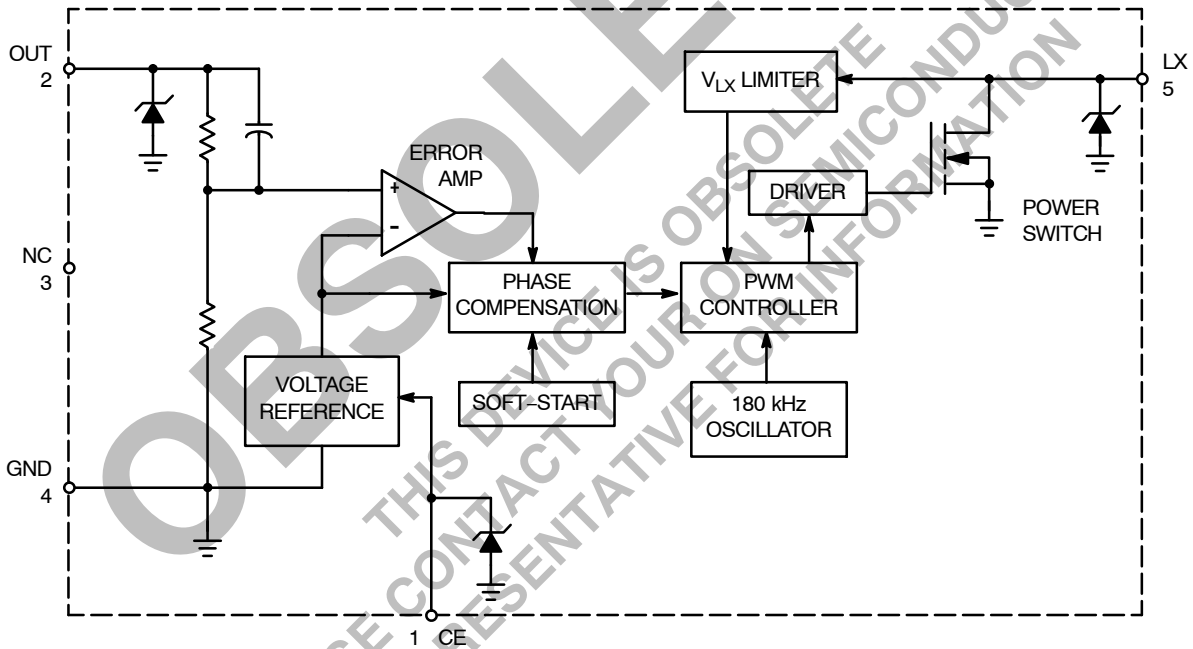
$V_{IN} = 1.5 \text{ V}$ ,  $L = 22 \mu\text{H}$   
 1.  $V_{OUT} = 5.0 \text{ V}$  (AC coupled), 50 mV/div  
 2.  $I_O = 3.0 \text{ mA}$  to 30 mA

**Figure 38. NCP1400ASN50T1  
 Load Transient Response**



$V_{IN} = 1.5 \text{ V}$ ,  $L = 22 \mu\text{H}$   
 1.  $V_{OUT} = 5.0 \text{ V}$  (AC coupled), 50 mV/div  
 2.  $I_O = 30 \text{ mA}$  to 3.0 mA

**Figure 39. NCP1400ASN50T1  
 Load Transient Response**



**Figure 40. Representative Block Diagram**

## PIN FUNCTION DESCRIPTION

Pin #	Symbol	Pin Description
1	CE	Chip Enable Pin (1) The chip is enabled if a voltage equal to or greater than 0.9 V is applied. (2) The chip is disabled if a voltage less than 0.3 V is applied. (3) The chip is enabled if this pin is left floating.
2	OUT	Output voltage monitor pin and also the power supply pin for the device.
3	NC	No internal connection to this pin.
4	GND	Ground pin.
5	LX	External inductor connection pin to power switch drain.

## DETAILED OPERATING DESCRIPTION

### Operation

The NCP1400A series are monolithic power switching regulators optimized for applications where power drain must be minimized. These devices operate as fixed frequency, voltage mode boost regulator and is designed to operate in the discontinuous conduction mode. Potential applications include low powered consumer products and battery powered portable products.

The NCP1400A series are low noise fixed frequency voltage-mode PWM DC-DC converters, and consist of soft-start circuit, feedback resistor, reference voltage, oscillator, loop compensation network, PWM control circuit, current limit circuit and power switch. Due to the on-chip feedback resistor and loop compensation network, the system designer can get the regulated output voltage from 1.8 V to 5.0 V with a small number of external components. The quiescent current is typically 32  $\mu\text{A}$  ( $V_{\text{OUT}} = 2.7 \text{ V}$ ), and can be further reduced to about 1.5  $\mu\text{A}$  when the chip is disabled ( $V_{\text{CE}} < 0.3 \text{ V}$ ).

### Soft-Start

There is a soft-start circuit in NCP1400A. When power is applied to the device, the soft-start circuit pumps up the output voltage to approximately 1.5 V at a fixed duty cycle, the level at which the converter can operate normally. What is more, the startup capability with heavy loads is also improved.

### Oscillator

The oscillator frequency is internally set to 180 kHz at an accuracy of  $\pm 20\%$  and with low temperature coefficient of  $0.11\%/^{\circ}\text{C}$ . Figures 16 and 17 illustrate oscillator frequency versus temperature.

### Regulated Converter Voltage ( $V_{\text{OUT}}$ )

The  $V_{\text{OUT}}$  is set by an internal feedback resistor network. This is trimmed to a selected voltage from 1.8 V to 5.0 V range in 100 mV steps with an accuracy of  $\pm 2.5\%$ . Note: When the duty cycle is less than about 12%, the regulator will skip switching cycles to maintain high efficiency at light loads. The regulated output will be raised by 3 to 4% under this condition.

### Compensation

The device is designed to operate in discontinuous conduction mode. An internal compensation circuit was designed to guarantee stability over the full input/output voltage and full output load range. Stability cannot be guaranteed in continuous conduction mode.

### Current Limit

The NCP1400A series utilizes cycle-by-cycle current limiting as a means of protecting the output switch MOSFET from overstress and preventing the small value inductor from saturation. Current limiting is implemented by monitoring the output MOSFET current build-up during conduction, and upon sensing an overcurrent conduction immediately turning off the switch for the duration of the oscillator cycle.

The voltage across the output MOSFET is monitored and compared against a reference by the VLX limiter. When the threshold is reached, a signal is sent to the PWM controller block to terminate the output switch conduction. The current limit threshold is typically set at 350 mA.

### Enable/Disable Operation

The NCP1400A series offer IC shutdown mode by chip enable pin (CE pin) to reduce current consumption. An internal 150 nA pull-up current source tied the CE pin to OUT pin by default, i.e., user can float the pin CE for permanent "On". When voltage at pin CE is equal or greater than 0.9 V, the chip will be enabled, which means the regulator is in normal operation. When voltage at pin CE is less than 0.3 V, the chip is disabled, which means IC is shutdown.

**Important: DO NOT apply a voltage between 0.3 V to 0.9 V to pin CE as this voltage will place the IC into an undefined state and the IC may drain excessive current from the supply.**

# NCP1400A

## APPLICATION CIRCUIT INFORMATION

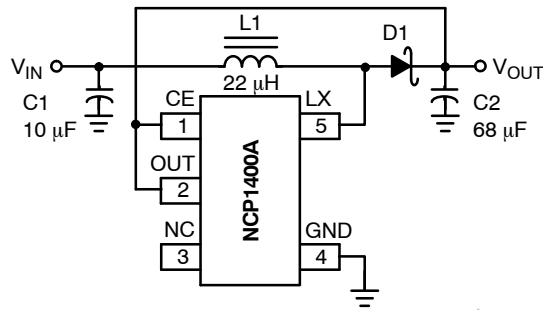


Figure 41. Typical Step-Up Converter Application

### Step-up Converter Design Equations

General step-up DC-DC converter designed to operate in discontinuous conduction mode can be defined by:

Calculation	Equation
D	$\frac{t_{on}}{T}$
$I_{PK}$	$\frac{V_{in} t_{on}}{L}$
$I_O$	$\frac{(V_{in})^2 (t_{on})^2 f}{2L(V_{out} + V_F - V_{in})}$

- D - Duty cycle
  - $I_{PK}$  - Peak inductor current
  - $I_O$  - Desired dc output current
  - $V_{IN}$  - Nominal operating dc input voltage
  - $V_{OUT}$  - Desired dc output voltage
  - $V_F$  - Diode forward voltage
- Assume saturation voltage of the internal FET switch is negligible.

### External Component Selection

#### Inductor

Inductance values between 18 µH and 27 µH are the best suitable values for NCP1400A. In general, smaller inductance values can provide larger peak inductor current and output current capability, and lower conversion efficiency, and vice versa. Select an inductor with smallest possible DCR, usually less than 1.0 Ω, to minimize loss. It is necessary to choose an inductor with saturation current greater than the peak current which the inductor will encounter in the application. The inductor selected should be able to handle the worst case peak inductor current without saturation.

#### Diode

The diode is the largest source of loss in DC-DC converters. The most importance parameters which affect their efficiency are the forward voltage drop,  $V_F$ , and the reverse recovery time,  $t_{rr}$ . The forward voltage drop creates a loss just by having a voltage across the device while a current flowing through it. The reverse recovery time generates a loss when the diode is reverse biased, and the current appears to actually flow backwards through the diode due to the minority carriers being swept from the P-N junction. A Schottky diode with the following characteristics is recommended:

- Small forward voltage,  $V_F < 0.3 \text{ V}$
- Small reverse leakage current
- Fast reverse recovery time/switching speed
- Rated current larger than peak inductor current,  $I_{rated} > I_{PK}$
- Reverse voltage larger than output voltage,  $V_{reverse} > V_{OUT}$

#### Input Capacitor

The input capacitor can stabilize the input voltage and minimize peak current ripple from the source. The value of the capacitor depends on the impedance of the input source used. Small Equivalent Series Resistance (ESR) Tantalum or ceramic capacitor with value of 10 µF should be suitable.

#### Output Capacitor

The output capacitor is used for sustaining the output voltage when the internal MOSFET is switched on and smoothing the ripple voltage. Low ESR capacitor should be used to reduce output ripple voltage. In general, a 47 µF to 68 µF low ESR (0.15 Ω to 0.30 Ω) Tantalum capacitor should be appropriate.

## NCP1400A

An evaluation board of NCP1400A has been made in the small size of 23 mm x 20 mm and is shown in Figures 42 and 43. Please contact your ON Semiconductor

representative for availability. The evaluation board schematic diagram, the artwork and the silkscreen of the surface mount PCB are shown below:

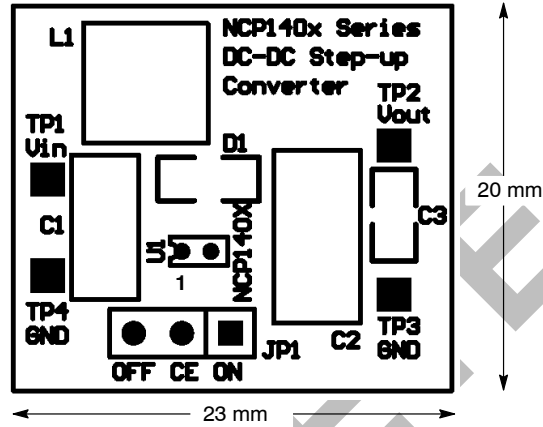


Figure 42. NCP1400A PWM Step-up DC-DC Converter Evaluation Board Silkscreen

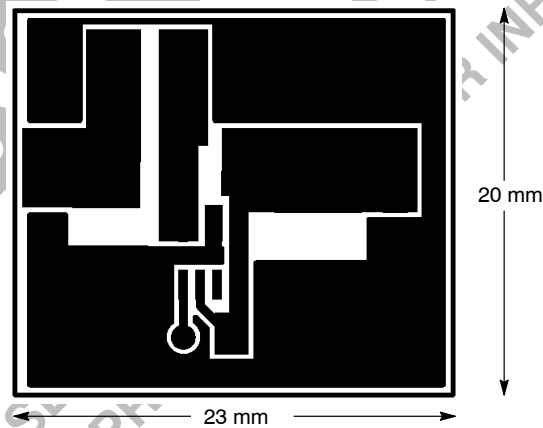


Figure 43. NCP1400A PWM Step-up DC-DC Converter Evaluation Board Artwork (Component Side)

# NCP1400A

## Components Supplier

Parts	Supplier	Part Number	Description	Phone
Inductor, L1	Sumida Electric Co. Ltd.	CR54-220MC	Inductor 22 $\mu$ H/1.11 A	(852) 2880-6688
Schottky Diode, D1	ON Semiconductor Corp.	MBR0520LT1	Schottky Power Rectifier	(852) 2689-0088
Output Capacitor, C2	KEMET Electronics Corp.	T494D686K010AS	Low ESR Tantalum Capacitor 68 $\mu$ F/10 V	(852) 2305-1168
Input Capacitor, C1	KEMET Electronics Corp.	T491C106K016AS	Low Profile Tantalum Capacitor 10 $\mu$ F/16 V	(852) 2305-1168

## PCB Layout Hints

### Grounding

One point grounding should be used for the output power return ground, the input power return ground, and the device switch ground to reduce noise as shown in Figure 44, e.g.: C2 GND, C1 GND, and U1 GND are connected at one point in the evaluation board. The input ground and output ground traces must be thick enough for current to flow through and for reducing ground bounce.

### Power Signal Traces

Low resistance conducting paths should be used for the power carrying traces to reduce power loss so as to improve

efficiency (short and thick traces for connecting the inductor L can also reduce stray inductance), e.g. short and thick traces listed below are used in the evaluation board:

1. Trace from TP1 to L1
2. Trace from L1 to Lx pin of U1
3. Trace from L1 to anode pin of D1
4. Trace from cathode pin of D1 to TP2

### Output Capacitor

The output capacitor should be placed close to the output terminals to obtain better smoothing effect on the output ripple.

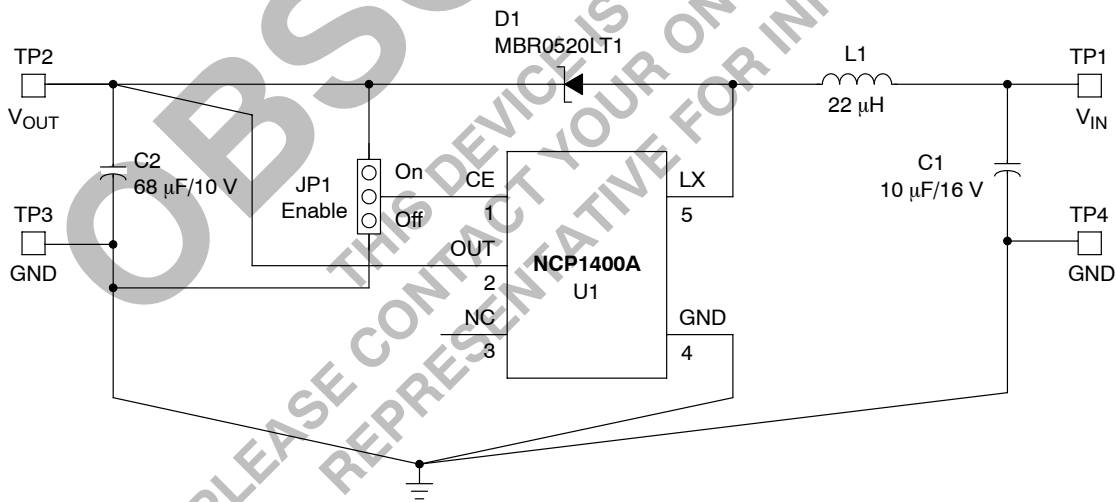
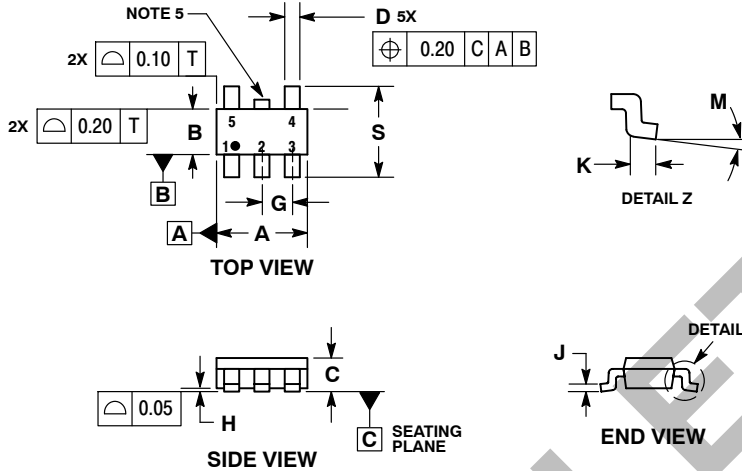


Figure 44. NCP1400A Evaluation Board Schematic Diagram

# NCP1400A

## PACKAGE DIMENSIONS

TSOP-5  
SN SUFFIX  
CASE 483-02  
ISSUE K

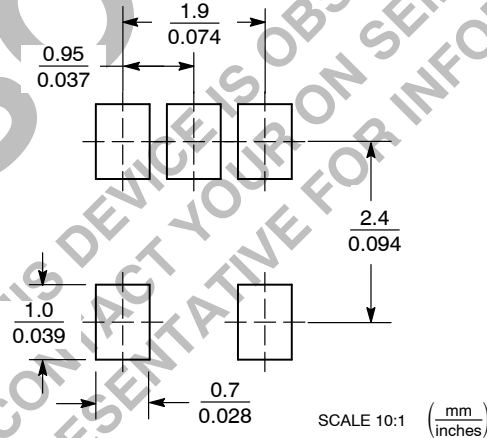


NOTES:

1. DIMENSIONING AND TOLERANCING PER ASME Y14.5M, 1994.
2. CONTROLLING DIMENSION: MILLIMETERS.
3. MAXIMUM LEAD THICKNESS INCLUDES LEAD FINISH THICKNESS. MINIMUM LEAD THICKNESS IS THE MINIMUM THICKNESS OF BASE MATERIAL.
4. DIMENSIONS A AND B DO NOT INCLUDE MOLD FLASH, PROTRUSIONS, OR GATE BURRS. MOLD FLASH, PROTRUSIONS, OR GATE BURRS SHALL NOT EXCEED 0.15 PER SIDE. DIMENSION A.
5. OPTIONAL CONSTRUCTION: AN ADDITIONAL TRIMMED LEAD IS ALLOWED IN THIS LOCATION. TRIMMED LEAD NOT TO EXTEND MORE THAN 0.2 FROM BODY.

DIM	MILLIMETERS	
	MIN	MAX
A	3.00 BSC	
B	1.50 BSC	
C	0.90	1.10
D	0.25	0.50
G	0.95 BSC	
H	0.01	0.10
J	0.10	0.26
K	0.20	0.60
M	0°	10°
S	2.50	3.00

### SOLDERING FOOTPRINT\*



\*For additional information on our Pb-Free strategy and soldering details, please download the ON Semiconductor Soldering and Mounting Techniques Reference Manual, SOLDERRM/D.

ON Semiconductor and are registered trademarks of Semiconductor Components Industries, LLC (SCILLC). SCILLC owns the rights to a number of patents, trademarks, copyrights, trade secrets, and other intellectual property. A listing of SCILLC's product/patent coverage may be accessed at [www.onsemi.com/site/pdf/Patent-Marking.pdf](http://www.onsemi.com/site/pdf/Patent-Marking.pdf). SCILLC reserves the right to make changes without further notice to any products herein. SCILLC makes no warranty, representation or guarantee regarding the suitability of its products for any particular purpose, nor does SCILLC assume any liability arising out of the application or use of any product or circuit, and specifically disclaims any and all liability, including without limitation special, consequential or incidental damages. "Typical" parameters which may be provided in SCILLC data sheets and/or specifications can and do vary in different applications and actual performance may vary over time. All operating parameters, including "Typicals" must be validated for each customer application by customer's technical experts. SCILLC does not convey any license under its patent rights nor the rights of others. SCILLC products are not designed, intended, or authorized for use as components in systems intended for surgical implant into the body, or other applications intended to support or sustain life, or for any other application in which the failure of the SCILLC product could create a situation where personal injury or death may occur. Should Buyer purchase or use SCILLC products for any such unintended or unauthorized application, Buyer shall indemnify and hold SCILLC and its officers, employees, subsidiaries, affiliates, and distributors harmless against all claims, costs, damages, and expenses, and reasonable attorney fees arising out of, directly or indirectly, any claim of personal injury or death associated with such unintended or unauthorized use, even if such claim alleges that SCILLC was negligent regarding the design or manufacture of the part. SCILLC is an Equal Opportunity/Affirmative Action Employer. This literature is subject to all applicable copyright laws and is not for resale in any manner.

### PUBLICATION ORDERING INFORMATION

**LITERATURE FULFILLMENT:**  
Literature Distribution Center for ON Semiconductor  
P.O. Box 5163, Denver, Colorado 80217 USA  
Phone: 303-675-2175 or 800-344-3860 Toll Free USA/Canada  
Fax: 303-675-2176 or 800-344-3867 Toll Free USA/Canada  
Email: [orderlit@onsemi.com](mailto:orderlit@onsemi.com)

**N. American Technical Support:** 800-282-9855 Toll Free  
USA/Canada  
**Europe, Middle East and Africa Technical Support:**  
Phone: 421 33 790 2910  
**Japan Customer Focus Center**  
Phone: 81-3-5817-1050

**ON Semiconductor Website:** [www.onsemi.com](http://www.onsemi.com)  
**Order Literature:** <http://www.onsemi.com/orderlit>

For additional information, please contact your local Sales Representative

## Looking for pricing, stock, or lifecycle information?

Click below to explore more details on WIN SOURCE:

- ⊖ [View NCP1400ASN50T1 on WIN SOURCE](#)
- ⊖ [ON Semiconductor Information](#)

## Optimize Your Supply Chain with WIN SOURCE Solutions

- ✓ Global Sourcing Solution
- ✓ Obsolete Management
- ✓ Cost Control Management
- ✓ Shortage Management
- ✓ Alternative Solution
- ✓ Excess Inventory Management