

AN77Lxx/AN77LxxM Series

3-pin, positive output, low dropout voltage regulator (100 mA type)

■ Overview

The AN77Lxx series and the AN77LxxM series are stabilized constant voltage power supplies with a low input/output voltage difference (0.22V typ. for AN77L03). It is suitable for the low-voltage equipment using batteries and consumer/industrial equipment with great fluctuation of the supply voltage.

■ Features

- Minimum input/output voltage difference: 0.22V typ. (3V type)
- Built-in overcurrent limit circuit
- Built-in rush current prevention circuit at input voltage rise
- Built-in overheat protection circuit
- Built-in input short-circuit protection circuit
- Output voltage: 3V, 3.5V, 4V, 4.5V, 5V, 6V, 7V, 8V, 9V, 10V, 12V

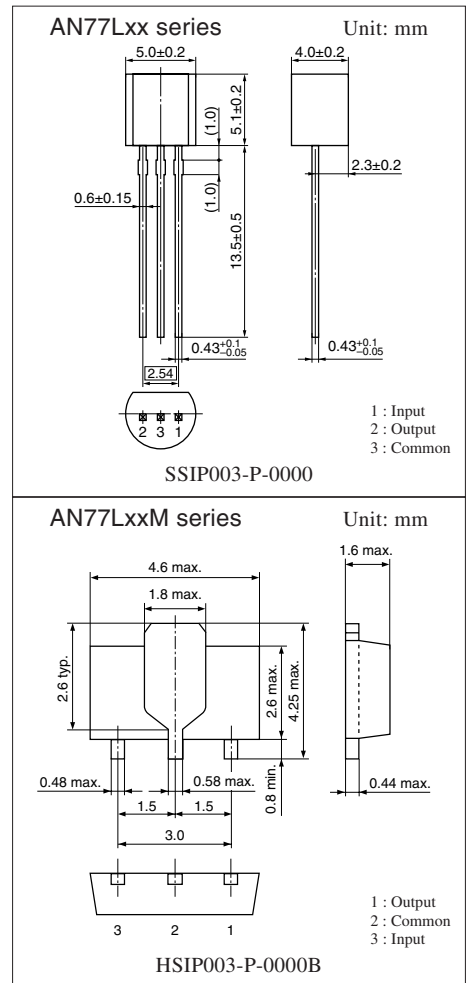

Note) The packages (SSIP003-P-0000 and HSIP003-P-0000B) of this product will be changed to lead-free type (SSIP003-P-0000S and HSIP003-P-0000Q). See the new package dimensions section later of this datasheet.

■ Block Diagram (AN77LxxM series)

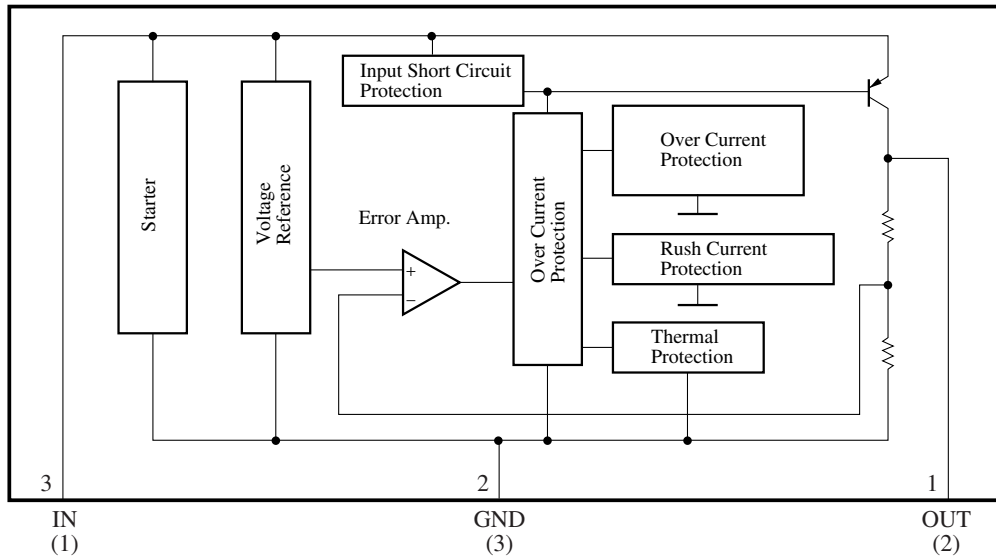

Note) The number in () shows the pin number for the AN77Lxx series.

■ Absolute Maximum Ratings at $T_a = 25^\circ\text{C}$

Parameter	Symbol	Rating	Unit
Supply voltage	V_{IN}	30	V
Supply current	I_{IN}	200	mA
Power dissipation *	P_D	650	mW
Operating ambient temperature	T_{opr}	-30 to +85	$^\circ\text{C}$
Storage temperature	T_{stg}	-55 to +150	$^\circ\text{C}$

* HSIP003-P-0000B is mounted on a standard board (glass epoxy: 20mm × 20mm × t1.7mm with Cu foil of 1cm² or more).

■ Recommended Operating Range at $T_a = 25^\circ\text{C}$

Part No.	Output voltage (V_O)	Operation supply voltage range (V_I)	Unit
AN77L03, AN77L03M	3	$V_O + 0.3$ to 13.62	V
AN77L035, AN77L035M	3.5	$V_O + 0.41$ to 14.14	V
AN77L04, AN77L04M	4	$V_O + 0.3$ to 14.66	V
AN77L045, AN77L045M	4.5	$V_O + 0.43$ to 15.18	V
AN77L05, AN77L05M	5	$V_O + 0.3$ to 15.7	V
AN77L06, AN77L06M	6	$V_O + 0.46$ to 16.74	V
AN77L07, AN77L07M	7	$V_O + 0.48$ to 17.78	V
AN77L08, AN77L08M	8	$V_O + 0.51$ to 18.82	V
AN77L09, AN77L09M	9	$V_O + 0.53$ to 19.86	V
AN77L10, AN77L10M	10	$V_O + 0.55$ to 20.9	V
AN77L12, AN77L12M	12	$V_O + 0.6$ to 22.98	V

■ Electrical Characteristics at $T_a = 25^\circ\text{C}$

• AN77L03, AN77L03M (3V, 100mA type)

Parameter	Symbol	Conditions	Min	Typ	Max	Unit
Output voltage	V_O	$T_j = 25^\circ\text{C}$	2.88	3	3.12	V
Line regulation	REG_{IN}	$V_1 = 3.62$ to 13.62V , $T_j = 25^\circ\text{C}$	—	2	60	mV
Load regulation	REG_{L}	$I_O = 0$ to 100mA , $T_j = 25^\circ\text{C}$	—	8	60	mV
Bias current under no load	I_{Bias}	$I_O = 0\text{mA}$, $T_j = 25^\circ\text{C}$	—	0.9	1.5	mA
Bias current fluctuation to load	ΔI_{Bias}	$I_O = 0$ to 100mA , $T_j = 25^\circ\text{C}$	—	3	5	mA
Bias current before regulation start	I_{rush}	$V_1 = 2.7\text{V}$, $I_O = 0\text{mA}$, $T_j = 25^\circ\text{C}$	—	1.5	5	mA
Ripple rejection ratio	RR	$V_1 = 3.62$ to 5.62V , $f = 120\text{Hz}$	60	70	—	dB
Minimum input/output voltage difference 1	$V_{\text{DIF}(\text{min})1}$	$V_1 = 2.7\text{V}$, $I_O = 50\text{mA}$, $T_j = 25^\circ\text{C}$	—	0.12	0.25	V
Minimum input/output voltage difference 2	$V_{\text{DIF}(\text{min})2}$	$V_1 = 2.7\text{V}$, $I_O = 100\text{mA}$, $T_j = 25^\circ\text{C}$	—	0.22	0.3	V
Output noise voltage	V_{no}	$f = 10\text{Hz}$ to 100kHz	—	70	—	μV
Output voltage temperature coefficient	$\Delta V_O/T_a$	$T_j = -30$ to $+125^\circ\text{C}$	—	0.2	—	$\text{mV}/^\circ\text{C}$

Note 1) The specified condition $T_j = 25^\circ\text{C}$ means that the test should be carried out within so short a test time (within 10ms) that the characteristic value drift due to the chip junction temperature rise can be ignored.

Note 2) Unless otherwise specified, $V_1 = 4\text{V}$, $I_O = 50\text{mA}$ and $C_O = 10\mu\text{F}$

• AN77L035, AN77L035M (3.5V, 100mA type)

Parameter	Symbol	Conditions	Min	Typ	Max	Unit
Output voltage	V_O	$T_j = 25^\circ\text{C}$	3.36	3.5	3.64	V
Line regulation	REG_{IN}	$V_1 = 4.14$ to 14.14V , $T_j = 25^\circ\text{C}$	—	3	60	mV
Load regulation	REG_{L}	$I_O = 0$ to 100mA , $T_j = 25^\circ\text{C}$	—	9	60	mV
Bias current under no load	I_{Bias}	$I_O = 0\text{mA}$, $T_j = 25^\circ\text{C}$	—	0.9	1.5	mA
Bias current fluctuation to load	ΔI_{Bias}	$I_O = 0$ to 100mA , $T_j = 25^\circ\text{C}$	—	3	5	mA
Bias current before regulation start	I_{rush}	$V_1 = 3.15\text{V}$, $I_O = 0\text{mA}$, $T_j = 25^\circ\text{C}$	—	1.5	5	mA
Ripple rejection ratio	RR	$V_1 = 4.14$ to 6.14V , $f = 120\text{Hz}$	59	69	—	dB
Minimum input/output voltage difference 1	$V_{\text{DIF}(\text{min})1}$	$V_1 = 3.15\text{V}$, $I_O = 50\text{mA}$, $T_j = 25^\circ\text{C}$	—	0.12	0.25	V
Minimum input/output voltage difference 2	$V_{\text{DIF}(\text{min})2}$	$V_1 = 3.15\text{V}$, $I_O = 100\text{mA}$, $T_j = 25^\circ\text{C}$	—	0.22	0.41	V
Output noise voltage	V_{no}	$f = 10\text{Hz}$ to 100kHz	—	75	—	μV
Output voltage temperature coefficient	$\Delta V_O/T_a$	$T_j = -30$ to $+125^\circ\text{C}$	—	0.23	—	$\text{mV}/^\circ\text{C}$

Note 1) The specified condition $T_j = 25^\circ\text{C}$ means that the test should be carried out within so short a test time (within 10ms) that the characteristic value drift due to the chip junction temperature rise can be ignored.

Note 2) Unless otherwise specified, $V_1 = 4.5\text{V}$, $I_O = 50\text{mA}$ and $C_O = 10\mu\text{F}$

• AN77L04, AN77L04M (4V, 100mA type)

Parameter	Symbol	Conditions	Min	Typ	Max	Unit
Output voltage	V_O	$T_j = 25^\circ\text{C}$	3.84	4	4.16	V
Line regulation	REG_{IN}	$V_1 = 4.66$ to 14.66V , $T_j = 25^\circ\text{C}$	—	3	60	mV
Load regulation	REG_{L}	$I_O = 0$ to 100mA , $T_j = 25^\circ\text{C}$	—	9	60	mV
Bias current under no load	I_{Bias}	$I_O = 0\text{mA}$, $T_j = 25^\circ\text{C}$	—	0.9	1.5	mA
Bias current fluctuation to load	ΔI_{Bias}	$I_O = 0$ to 100mA , $T_j = 25^\circ\text{C}$	—	3	5	mA
Bias current before regulation start	I_{rush}	$V_1 = 3.6\text{V}$, $I_O = 0\text{mA}$, $T_j = 25^\circ\text{C}$	—	1.5	5	mA
Ripple rejection ratio	RR	$V_1 = 4.66$ to 6.66V , $f = 120\text{Hz}$	59	69	—	dB
Minimum input/output voltage difference 1	$V_{\text{DIF}(\text{min})1}$	$V_1 = 3.6\text{V}$, $I_O = 50\text{mA}$, $T_j = 25^\circ\text{C}$	—	0.12	0.25	V
Minimum input/output voltage difference 2	$V_{\text{DIF}(\text{min})2}$	$V_1 = 3.6\text{V}$, $I_O = 100\text{mA}$, $T_j = 25^\circ\text{C}$	—	0.23	0.3	V
Output noise voltage	V_{no}	$f = 10\text{Hz}$ to 100kHz	—	80	—	μV
Output voltage temperature coefficient	$\Delta V_O/T_a$	$T_j = -30$ to $+125^\circ\text{C}$	—	0.26	—	$\text{mV}/^\circ\text{C}$

Note 1) The specified condition $T_j = 25^\circ\text{C}$ means that the test should be carried out within so short a test time (within 10ms) that the characteristic value drift due to the chip junction temperature rise can be ignored.

Note 2) Unless otherwise specified, $V_1 = 5\text{V}$, $I_O = 50\text{mA}$ and $C_O = 10\mu\text{F}$

■ Electrical Characteristics at $T_a = 25^\circ\text{C}$ (continued)

• AN77L045, AN77L045M (4.5V, 100mA type)

Parameter	Symbol	Conditions	Min	Typ	Max	Unit
Output voltage	V_O	$T_j = 25^\circ\text{C}$	4.32	4.5	4.68	V
Line regulation	REG_{IN}	$V_1 = 5.18 \text{ to } 15.18\text{V}, T_j = 25^\circ\text{C}$	—	3	60	mV
Load regulation	REG_{L}	$I_O = 0 \text{ to } 100\text{mA}, T_j = 25^\circ\text{C}$	—	10	60	mV
Bias current under no load	I_{Bias}	$I_O = 0\text{mA}, T_j = 25^\circ\text{C}$	—	0.9	1.5	mA
Bias current fluctuation to load	ΔI_{Bias}	$I_O = 0 \text{ to } 100\text{mA}, T_j = 25^\circ\text{C}$	—	3	5	mA
Bias current before regulation start	I_{rush}	$V_1 = 4.05\text{V}, I_O = 0\text{mA}, T_j = 25^\circ\text{C}$	—	1.5	5	mA
Ripple rejection ratio	RR	$V_1 = 7.18 \text{ to } 6.18\text{V}, f = 120\text{Hz}$	58	68	—	dB
Minimum input/output voltage difference 1	$V_{\text{DIF}(\text{min})1}$	$V_1 = 4.05\text{V}, I_O = 50\text{mA}, T_j = 25^\circ\text{C}$	—	0.12	0.25	V
Minimum input/output voltage difference 2	$V_{\text{DIF}(\text{min})2}$	$V_1 = 4.05\text{V}, I_O = 100\text{mA}, T_j = 25^\circ\text{C}$	—	0.23	0.43	V
Output noise voltage	V_{no}	$f = 10\text{Hz to } 100\text{kHz}$	—	85	—	μV
Output voltage temperature coefficient	$\Delta V_O/T_a$	$T_j = -30 \text{ to } +125^\circ\text{C}$	—	0.3	—	$\text{mV}/^\circ\text{C}$

Note 1) The specified condition $T_j = 25^\circ\text{C}$ means that the test should be carried out within so short a test time (within 10ms) that the characteristic value drift due to the chip junction temperature rise can be ignored.

Note 2) Unless otherwise specified, $V_1 = 5.5\text{V}$, $I_O = 50\text{mA}$ and $C_O = 10\mu\text{F}$

• AN77L05, AN77L05M (5V, 100mA type)

Parameter	Symbol	Conditions	Min	Typ	Max	Unit
Output voltage	V_O	$T_j = 25^\circ\text{C}$	4.8	5	5.2	V
Line regulation	REG_{IN}	$V_1 = 5.7 \text{ to } 15.7\text{V}, T_j = 25^\circ\text{C}$	—	4	60	mV
Load regulation	REG_{L}	$I_O = 0 \text{ to } 100\text{mA}, T_j = 25^\circ\text{C}$	—	10	60	mV
Bias current under no load	I_{Bias}	$I_O = 0\text{mA}, T_j = 25^\circ\text{C}$	—	0.9	1.5	mA
Bias current fluctuation to load	ΔI_{Bias}	$I_O = 0 \text{ to } 100\text{mA}, T_j = 25^\circ\text{C}$	—	3	5	mA
Bias current before regulation start	I_{rush}	$V_1 = 4.5\text{V}, I_O = 0\text{mA}, T_j = 25^\circ\text{C}$	—	1.5	5	mA
Ripple rejection ratio	RR	$V_1 = 5.7 \text{ to } 7.7\text{V}, f = 120\text{Hz}$	58	68	—	dB
Minimum input/output voltage difference 1	$V_{\text{DIF}(\text{min})1}$	$V_1 = 4.5\text{V}, I_O = 50\text{mA}, T_j = 25^\circ\text{C}$	—	0.12	0.25	V
Minimum input/output voltage difference 2	$V_{\text{DIF}(\text{min})2}$	$V_1 = 4.5\text{V}, I_O = 100\text{mA}, T_j = 25^\circ\text{C}$	—	0.24	0.3	V
Output noise voltage	V_{no}	$f = 10\text{Hz to } 100\text{kHz}$	—	90	—	μV
Output voltage temperature coefficient	$\Delta V_O/T_a$	$T_j = -30 \text{ to } +125^\circ\text{C}$	—	0.33	—	$\text{mV}/^\circ\text{C}$

Note 1) The specified condition $T_j = 25^\circ\text{C}$ means that the test should be carried out within so short a test time (within 10ms) that the characteristic value drift due to the chip junction temperature rise can be ignored.

Note 2) Unless otherwise specified, $V_1 = 6\text{V}$, $I_O = 50\text{mA}$ and $C_O = 10\mu\text{F}$

• AN77L06, AN77L06M (6V, 100mA type)

Parameter	Symbol	Conditions	Min	Typ	Max	Unit
Output voltage	V_O	$T_j = 25^\circ\text{C}$	5.76	6	6.24	V
Line regulation	REG_{IN}	$V_1 = 6.74 \text{ to } 16.74\text{V}, T_j = 25^\circ\text{C}$	—	4	60	mV
Load regulation	REG_{L}	$I_O = 0 \text{ to } 100\text{mA}, T_j = 25^\circ\text{C}$	—	11	60	mV
Bias current under no load	I_{Bias}	$I_O = 0\text{mA}, T_j = 25^\circ\text{C}$	—	0.9	1.5	mA
Bias current fluctuation to load	ΔI_{Bias}	$I_O = 0 \text{ to } 100\text{mA}, T_j = 25^\circ\text{C}$	—	3	5	mA
Bias current before regulation start	I_{rush}	$V_1 = 5.4\text{V}, I_O = 0\text{mA}, T_j = 25^\circ\text{C}$	—	1.5	5	mA
Ripple rejection ratio	RR	$V_1 = 6.74 \text{ to } 8.74\text{V}, f = 120\text{Hz}$	56	66	—	dB
Minimum input/output voltage difference 1	$V_{\text{DIF}(\text{min})1}$	$V_1 = 5.4\text{V}, I_O = 50\text{mA}, T_j = 25^\circ\text{C}$	—	0.12	0.25	V
Minimum input/output voltage difference 2	$V_{\text{DIF}(\text{min})2}$	$V_1 = 5.4\text{V}, I_O = 100\text{mA}, T_j = 25^\circ\text{C}$	—	0.25	0.46	V
Output noise voltage	V_{no}	$f = 10\text{Hz to } 100\text{kHz}$	—	105	—	μV
Output voltage temperature coefficient	$\Delta V_O/T_a$	$T_j = -30 \text{ to } +125^\circ\text{C}$	—	0.4	—	$\text{mV}/^\circ\text{C}$

Note 1) The specified condition $T_j = 25^\circ\text{C}$ means that the test should be carried out within so short a test time (within 10ms) that the characteristic value drift due to the chip junction temperature rise can be ignored.

Note 2) Unless otherwise specified, $V_1 = 7\text{V}$, $I_O = 50\text{mA}$ and $C_O = 10\mu\text{F}$

■ Electrical Characteristics at $T_a = 25^\circ\text{C}$ (continued)

• AN77L07, AN77L07M (7V, 100mA type)

Parameter	Symbol	Conditions	Min	Typ	Max	Unit
Output voltage	V_O	$T_j = 25^\circ\text{C}$	6.72	7.0	7.28	V
Line regulation	REG_{IN}	$V_I = 7.78$ to 17.78V , $T_j = 25^\circ\text{C}$	—	5	70	mV
Load regulation	REG_{L}	$I_O = 0$ to 100mA , $T_j = 25^\circ\text{C}$	—	11	70	mV
Bias current under no load	I_{Bias}	$I_O = 0\text{mA}$, $T_j = 25^\circ\text{C}$	—	1.1	1.6	mA
Bias current fluctuation to load	ΔI_{Bias}	$I_O = 0$ to 100mA , $T_j = 25^\circ\text{C}$	—	3	5	mA
Bias current before regulation start	I_{rush}	$V_I = 6.3\text{V}$, $I_O = 0\text{mA}$, $T_j = 25^\circ\text{C}$	—	1.5	5	mA
Ripple rejection ratio	RR	$V_I = 7.78$ to 9.78V , $f = 120\text{Hz}$	55	65	—	dB
Minimum input/output voltage difference 1	$V_{\text{DIF}(\text{min})1}$	$V_I = 6.3\text{V}$, $I_O = 50\text{mA}$, $T_j = 25^\circ\text{C}$	—	0.12	0.25	V
Minimum input/output voltage difference 2	$V_{\text{DIF}(\text{min})2}$	$V_I = 6.3\text{V}$, $I_O = 100\text{mA}$, $T_j = 25^\circ\text{C}$	—	0.26	0.48	V
Output noise voltage	V_{no}	$f = 10\text{Hz}$ to 100kHz	—	120	—	μV
Output voltage temperature coefficient	$\Delta V_O/T_a$	$T_j = -30$ to $+125^\circ\text{C}$	—	0.46	—	$\text{mV}/^\circ\text{C}$

Note 1) The specified condition $T_j = 25^\circ\text{C}$ means that the test should be carried out within so short a test time (within 10ms) that the characteristic value drift due to the chip junction temperature rise can be ignored.

Note 2) Unless otherwise specified, $V_I = 8\text{V}$, $I_O = 50\text{mA}$ and $C_O = 10\mu\text{F}$

• AN77L08, AN77L08M (8V, 100mA type)

Parameter	Symbol	Conditions	Min	Typ	Max	Unit
Output voltage	V_O	$T_j = 25^\circ\text{C}$	7.68	8	8.32	V
Line regulation	REG_{IN}	$V_I = 8.82$ to 18.82V , $T_j = 25^\circ\text{C}$	—	5	80	mV
Load regulation	REG_{L}	$I_O = 0$ to 100mA , $T_j = 25^\circ\text{C}$	—	12	80	mV
Bias current under no load	I_{Bias}	$I_O = 0\text{mA}$, $T_j = 25^\circ\text{C}$	—	1.1	1.6	mA
Bias current fluctuation to load	ΔI_{Bias}	$I_O = 0$ to 100mA , $T_j = 25^\circ\text{C}$	—	3	5	mA
Bias current before regulation start	I_{rush}	$V_I = 7.2\text{V}$, $I_O = 0\text{mA}$, $T_j = 25^\circ\text{C}$	—	1.5	5	mA
Ripple rejection ratio	RR	$V_I = 8.82$ to 10.82V , $f = 120\text{Hz}$	53	63	—	dB
Minimum input/output voltage difference 1	$V_{\text{DIF}(\text{min})1}$	$V_I = 7.2\text{V}$, $I_O = 50\text{mA}$, $T_j = 25^\circ\text{C}$	—	0.12	0.25	V
Minimum input/output voltage difference 2	$V_{\text{DIF}(\text{min})2}$	$V_I = 7.2\text{V}$, $I_O = 100\text{mA}$, $T_j = 25^\circ\text{C}$	—	0.27	0.51	V
Output noise voltage	V_{no}	$f = 10\text{Hz}$ to 100kHz	—	135	—	μV
Output voltage temperature coefficient	$\Delta V_O/T_a$	$T_j = -30$ to $+125^\circ\text{C}$	—	0.53	—	$\text{mV}/^\circ\text{C}$

Note 1) The specified condition $T_j = 25^\circ\text{C}$ means that the test should be carried out within so short a test time (within 10ms) that the characteristic value drift due to the chip junction temperature rise can be ignored.

Note 2) Unless otherwise specified, $V_I = 9\text{V}$, $I_O = 50\text{mA}$ and $C_O = 10\mu\text{F}$

• AN77L09, AN77L09M (9V, 100mA type)

Parameter	Symbol	Conditions	Min	Typ	Max	Unit
Output voltage	V_O	$T_j = 25^\circ\text{C}$	8.64	9	9.36	V
Line regulation	REG_{IN}	$V_I = 9.86$ to 19.86V , $T_j = 25^\circ\text{C}$	—	6	90	mV
Load regulation	REG_{L}	$I_O = 0$ to 100mA , $T_j = 25^\circ\text{C}$	—	13	90	mV
Bias current under no load	I_{Bias}	$I_O = 0\text{mA}$, $T_j = 25^\circ\text{C}$	—	1.2	1.7	mA
Bias current fluctuation to load	ΔI_{Bias}	$I_O = 0$ to 100mA , $T_j = 25^\circ\text{C}$	—	3	5	mA
Bias current before regulation start	I_{rush}	$V_I = 8.1\text{V}$, $I_O = 0\text{mA}$, $T_j = 25^\circ\text{C}$	—	1.5	5	mA
Ripple rejection ratio	RR	$V_I = 9.86$ to 11.86V , $f = 120\text{Hz}$	52	62	—	dB
Minimum input/output voltage difference 1	$V_{\text{DIF}(\text{min})1}$	$V_I = 8.1\text{V}$, $I_O = 50\text{mA}$, $T_j = 25^\circ\text{C}$	—	0.13	0.25	V
Minimum input/output voltage difference 2	$V_{\text{DIF}(\text{min})2}$	$V_I = 8.1\text{V}$, $I_O = 100\text{mA}$, $T_j = 25^\circ\text{C}$	—	0.28	0.53	V
Output noise voltage	V_{no}	$f = 10\text{Hz}$ to 100kHz	—	150	—	μV
Output voltage temperature coefficient	$\Delta V_O/T_a$	$T_j = -30$ to $+125^\circ\text{C}$	—	0.6	—	$\text{mV}/^\circ\text{C}$

Note 1) The specified condition $T_j = 25^\circ\text{C}$ means that the test should be carried out within so short a test time (within 10ms) that the characteristic value drift due to the chip junction temperature rise can be ignored.

Note 2) Unless otherwise specified, $V_I = 10\text{V}$, $I_O = 50\text{mA}$ and $C_O = 10\mu\text{F}$

■ Electrical Characteristics at $T_a = 25^\circ\text{C}$ (continued)

• AN77L10, AN77L10M (10V, 100mA type)

Parameter	Symbol	Conditions	Min	Typ	Max	Unit
Output voltage	V_O	$T_j = 25^\circ\text{C}$	9.6	10	10.4	V
Line regulation	REG_{IN}	$V_1 = 10.9$ to 20.9V , $T_j = 25^\circ\text{C}$	—	7	100	mV
Load regulation	REG_{L}	$I_O = 0$ to 100mA , $T_j = 25^\circ\text{C}$	—	14	100	mV
Bias current under no load	I_{Bias}	$I_O = 0\text{mA}$, $T_j = 25^\circ\text{C}$	—	1.2	1.7	mA
Bias current fluctuation to load	ΔI_{Bias}	$I_O = 0$ to 100mA , $T_j = 25^\circ\text{C}$	—	3	5	mA
Bias current before regulation start	I_{rush}	$V_1 = 9.0\text{V}$, $I_O = 0\text{mA}$, $T_j = 25^\circ\text{C}$	—	1.5	5	mA
Ripple rejection ratio	RR	$V_1 = 10.9$ to 12.9V , $f = 120\text{Hz}$	50	60	—	dB
Minimum input/output voltage difference 1	$V_{\text{DIF}(\text{min})1}$	$V_1 = 9.0\text{V}$, $I_O = 50\text{mA}$, $T_j = 25^\circ\text{C}$	—	0.13	0.25	V
Minimum input/output voltage difference 2	$V_{\text{DIF}(\text{min})2}$	$V_1 = 9.0\text{V}$, $I_O = 100\text{mA}$, $T_j = 25^\circ\text{C}$	—	0.29	0.55	V
Output noise voltage	V_{no}	$f = 10\text{Hz}$ to 100kHz	—	165	—	μV
Output voltage temperature coefficient	$\Delta V_O/T_a$	$T_j = -30$ to $+125^\circ\text{C}$	—	0.67	—	$\text{mV}/^\circ\text{C}$

Note 1) The specified condition $T_j = 25^\circ\text{C}$ means that the test should be carried out within so short a test time (within 10ms) that the characteristic value drift due to the chip junction temperature rise can be ignored.

Note 2) Unless otherwise specified, $V_1 = 11\text{V}$, $I_O = 50\text{mA}$ and $C_O = 10\mu\text{F}$

• AN77L12, AN77L12M (12V, 100mA type)

Parameter	Symbol	Conditions	Min	Typ	Max	Unit
Output voltage	V_O	$T_j = 25^\circ\text{C}$	11.52	12	12.48	V
Line regulation	REG_{IN}	$V_1 = 12.98$ to 22.98V , $T_j = 25^\circ\text{C}$	—	8	120	mV
Load regulation	REG_{L}	$I_O = 0$ to 100mA , $T_j = 25^\circ\text{C}$	—	15	120	mV
Bias current under no load	I_{Bias}	$I_O = 0\text{mA}$, $T_j = 25^\circ\text{C}$	—	1.4	1.9	mA
Bias current fluctuation to load	ΔI_{Bias}	$I_O = 0$ to 100mA , $T_j = 25^\circ\text{C}$	—	3	5	mA
Bias current before regulation start	I_{rush}	$V_1 = 10.8\text{V}$, $I_O = 0\text{mA}$, $T_j = 25^\circ\text{C}$	—	1.5	5	mA
Ripple rejection ratio	RR	$V_1 = 12.98$ to 14.98V , $f = 120\text{Hz}$	48	58	—	dB
Minimum input/output voltage difference 1	$V_{\text{DIF}(\text{min})1}$	$V_1 = 10.8\text{V}$, $I_O = 50\text{mA}$, $T_j = 25^\circ\text{C}$	—	0.13	0.25	V
Minimum input/output voltage difference 2	$V_{\text{DIF}(\text{min})2}$	$V_1 = 10.8\text{V}$, $I_O = 100\text{mA}$, $T_j = 25^\circ\text{C}$	—	0.31	0.6	V
Output noise voltage	V_{no}	$f = 10\text{Hz}$ to 100kHz	—	190	—	μV
Output voltage temperature coefficient	$\Delta V_O/T_a$	$T_j = -30$ to $+125^\circ\text{C}$	—	0.8	—	$\text{mV}/^\circ\text{C}$

Note 1) The specified condition $T_j = 25^\circ\text{C}$ means that the test should be carried out within so short a test time (within 10ms) that the characteristic value drift due to the chip junction temperature rise can be ignored.

Note 2) Unless otherwise specified, $V_1 = 13\text{V}$, $I_O = 50\text{mA}$ and $C_O = 10\mu\text{F}$

■ Main Characteristics

Input/output characteristic
 $V_O — V_I$

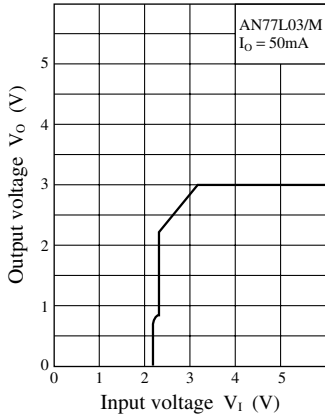

Line regulation
 $V_O — V_I$

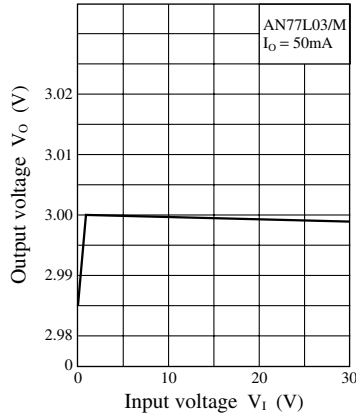

Rush current (under no load)
 $I_I — V_I$

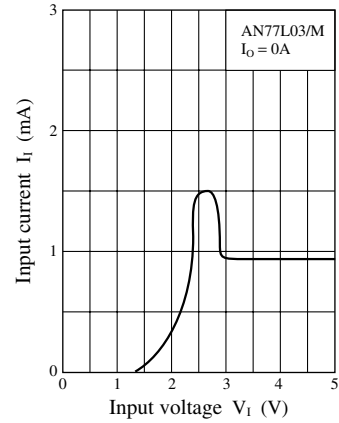

Bias current
 $I_{Bias} — I_O$

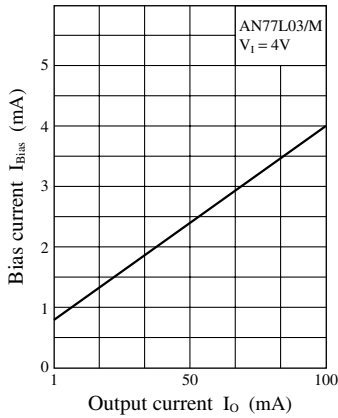

Load regulation
 $V_O — I_O$

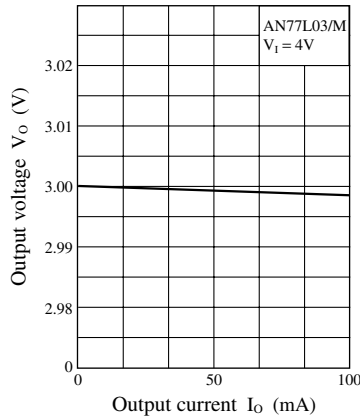

Overcurrent limit characteristic
 $V_O — I_O$

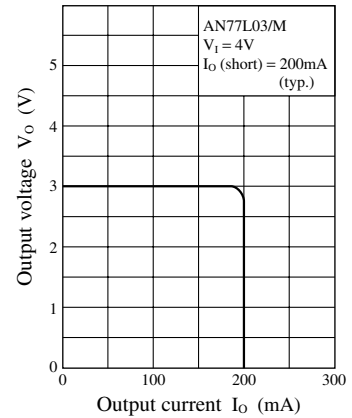

Minimum input/output voltage difference
 $V_{DIF(\text{min})} — I_{OUT}$

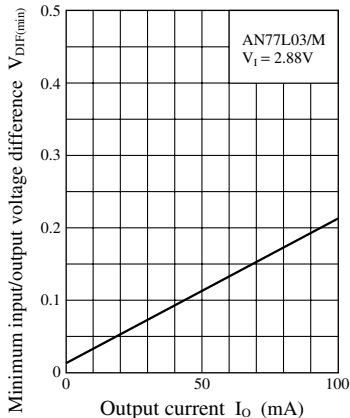

Ripple rejection ratio
 $RR — f$

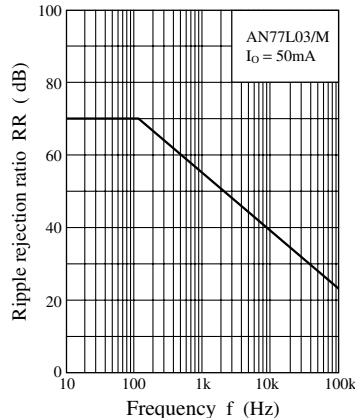

Output voltage temperature characteristic
 $V_O — T_a$

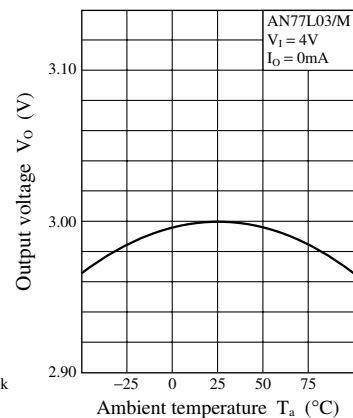

■ Main Characteristics (continued)

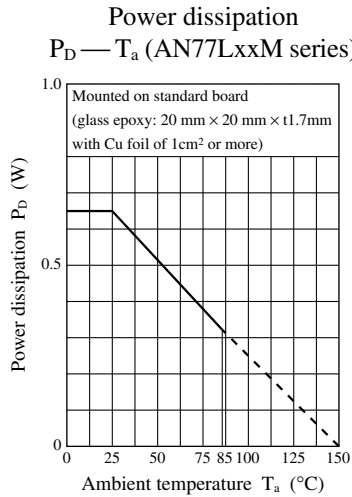
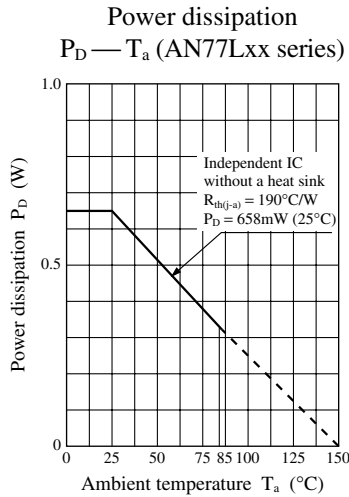

■ Usage Notes

1. Input short-circuit protection circuit

For the conventional Matsushita 3-pin regulators (such as of the AN80xx series), when DC input pin (pin 3) is short-circuited with GND pin (pin 2) in the normal operation condition, the potential of output pin (pin 1) becomes higher than that of DC input pin and the electric charges which is charged in output capacitor C_O flows in the input side, having resulted in the breakage of elements.

In the above case, the common silicon diode is connected as shown in the right figure (the dotted line). However, for the AN77Lxx/AN77LxxM series, since the protection circuit, which protects the elements from the discharging current, is incorporated in the internal circuit, the protection diode is not required.

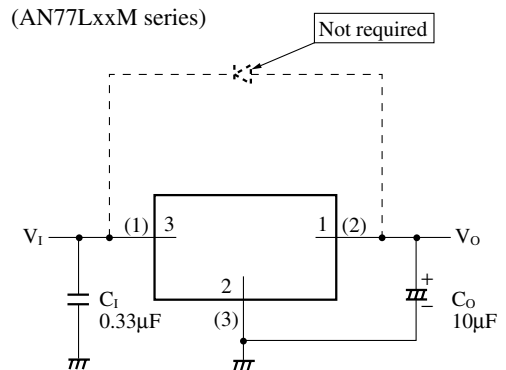

Note) The number in () shows the pin number for the AN77Lxx series.

2. Short-circuit between the output pin and the GND pin

Because there is no in-built protection circuit in the AN77Lxx/AN77LxxM series, they have the drooping characteristics as shown in the "■ Main Characteristics, Overcurrent limit characteristics". When your use under a high voltage happens to cause any short-circuit between the output pin (pin 1) and the GND pin (pin 2), the IC is likely to be broken.

3. Capacitor for external compensation

In order to secure the stability, the capacitor of 10µF is required in the output side and it should be added as near to output pin (pin 1) and GND pin (pin 2) as possible. When it is used under low temperature, oscillation may occur due to the decrease of the aluminum electrolytic capacitor's capacitance and an increase of ESR.

For the AN77Lxx/AN77LxxM series, it is recommended that the tantalum capacitor or aluminum electrolytic capacitor whose equivalent serial resistance with temperature characteristics within the recommended range specified in the right figure should be used.

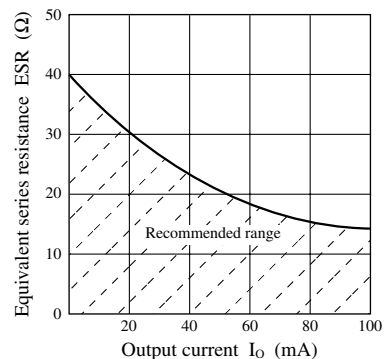

■ Application Circuit Example

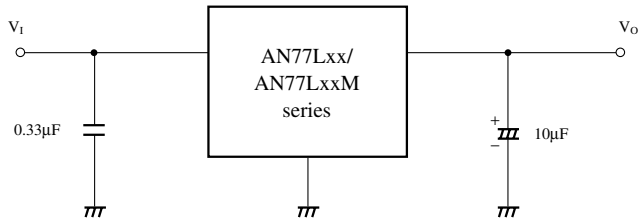

- For the AN77Lxx/AN77LxxM series, the gain inside the IC is set high to improve the performance. For the reason, use the capacitor of 10µF or more when the power line in the output side is long. In addition, install the capacitor in the output side as near as possible to the IC.

■ New Package Dimensions (Unit: mm)

- SSIP003-P-0000S (Lead-free package)

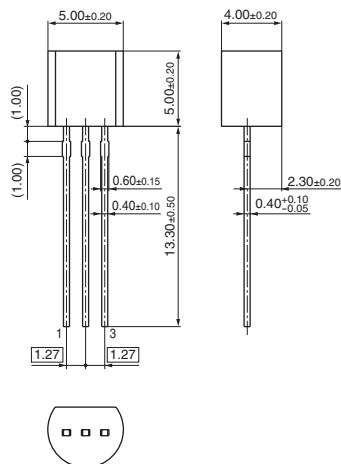

- HSIP003-P-0000Q (Lead-free package)

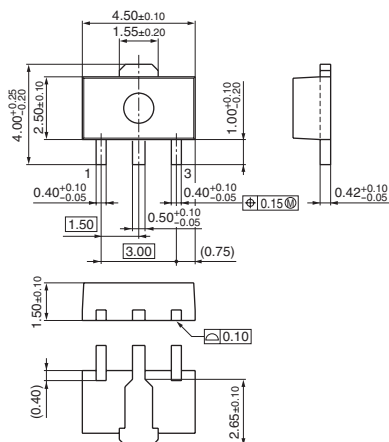

Request for your special attention and precautions in using the technical information and semiconductors described in this material

- (1) An export permit needs to be obtained from the competent authorities of the Japanese Government if any of the products or technologies described in this material and controlled under the "Foreign Exchange and Foreign Trade Law" is to be exported or taken out of Japan.
- (2) The technical information described in this material is limited to showing representative characteristics and applied circuits examples of the products. It neither warrants non-infringement of intellectual property right or any other rights owned by our company or a third party, nor grants any license.
- (3) We are not liable for the infringement of rights owned by a third party arising out of the use of the product or technologies as described in this material.
- (4) The products described in this material are intended to be used for standard applications or general electronic equipment (such as office equipment, communications equipment, measuring instruments and household appliances).
Consult our sales staff in advance for information on the following applications:
 - Special applications (such as for airplanes, aerospace, automobiles, traffic control equipment, combustion equipment, life support systems and safety devices) in which exceptional quality and reliability are required, or if the failure or malfunction of the products may directly jeopardize life or harm the human body.
 - Any applications other than the standard applications intended.
- (5) The products and product specifications described in this material are subject to change without notice for modification and/or improvement. At the final stage of your design, purchasing, or use of the products, therefore, ask for the most up-to-date Product Standards in advance to make sure that the latest specifications satisfy your requirements.
- (6) When designing your equipment, comply with the guaranteed values, in particular those of maximum rating, the range of operating power supply voltage, and heat radiation characteristics. Otherwise, we will not be liable for any defect which may arise later in your equipment.
Even when the products are used within the guaranteed values, take into the consideration of incidence of break down and failure mode, possible to occur to semiconductor products. Measures on the systems such as redundant design, arresting the spread of fire or preventing glitch are recommended in order to prevent physical injury, fire, social damages, for example, by using the products.
- (7) When using products for which damp-proof packing is required, observe the conditions (including shelf life and amount of time let standing of unsealed items) agreed upon when specification sheets are individually exchanged.
- (8) This material may be not reprinted or reproduced whether wholly or partially, without the prior written permission of Matsushita Electric Industrial Co., Ltd.







Looking for pricing, stock, or lifecycle information?

Click below to explore more details on WIN SOURCE:

 [View AN77L07M on WIN SOURCE](#)

 [Panasonic Information](#)

Optimize Your Supply Chain with WIN SOURCE Solutions

-  Global Sourcing Solution
-  Obsolete Management
-  Cost Control Management
-  Shortage Management
-  Alternative Solution
-  Excess Inventory Management