



**THE DATASHEET OF
AD9613BCPZ-170**



FEATURES

- SNR = 69.6 dBFS at 185 MHz f_{IN} and 250 MSPS
- SFDR = 86 dBc at 185 MHz f_{IN} and 250 MSPS
- 149.9 dBFS/Hz input noise at 185 MHz, –1 dBFS A_{IN} and 250 MSPS
- Total power consumption: 770 mW at 250 MSPS
- 1.8 V supply voltages
- LVDS (ANSI-644 levels) outputs
- Integer 1-to-8 input clock divider (625 MHz maximum input)
- Sample rates of up to 250 MSPS
- IF sampling frequencies of up to 400 MHz
- Internal ADC voltage reference
- Flexible analog input range
1.4 V p-p to 2.0 V p-p (1.75 V p-p nominal)
- ADC clock duty cycle stabilizer
- 95 dB channel isolation/crosstalk
- Serial port control
- Energy-saving power-down modes

APPLICATIONS

- Communications
- Diversity radio systems
- Multimode digital receivers (3G)
TD-SCDMA, WiMAX, W-CDMA, CDMA2000, GSM, EDGE, LTE
- I/Q demodulation systems
- Smart antenna systems
- General-purpose software radios
- Ultrasound equipment
- Broadband data applications

GENERAL DESCRIPTION

The **AD9613** is a dual 12-bit, analog-to-digital converter (ADC) with sampling speeds of up to 250 MSPS. The **AD9613** is designed to support communications applications where low cost, small size, wide bandwidth, and versatility are desired.

The dual ADC cores feature a multistage, differential pipelined architecture with integrated output error correction logic. Each ADC features wide bandwidth inputs supporting a variety of user-selectable input ranges. An integrated voltage reference eases design considerations. A duty cycle stabilizer (DCS) is provided to compensate for variations in the ADC clock duty cycle, allowing the converters to maintain excellent performance.

The ADC output data is routed directly to the two external 12-bit LVDS output ports and formatted as either interleaved or channel multiplexed.

Flexible power-down options allow significant power savings, when desired.

Rev. D

[Document Feedback](#)

Information furnished by Analog Devices is believed to be accurate and reliable. However, no responsibility is assumed by Analog Devices for its use, nor for any infringements of patents or other rights of third parties that may result from its use. Specifications subject to change without notice. No license is granted by implication or otherwise under any patent or patent rights of Analog Devices. Trademarks and registered trademarks are the property of their respective owners.

FUNCTIONAL BLOCK DIAGRAM

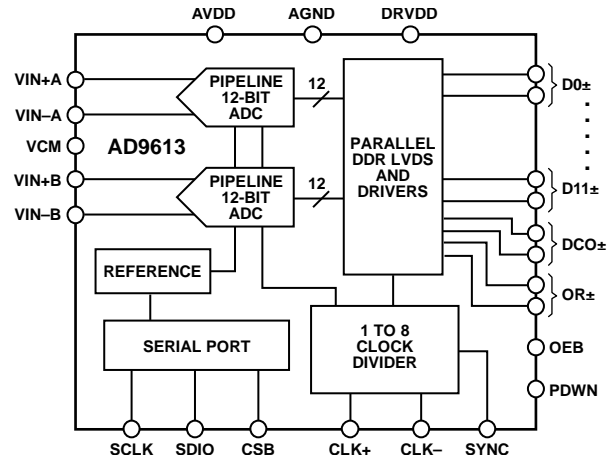

NOTES

1. THE D0± TO D11± PINS REPRESENT BOTH THE CHANNEL A AND CHANNEL B LVDS OUTPUT DATA.

Figure 1.

09837-001

Programming for setup and control is accomplished using a 3-wire SPI-compatible serial interface.

The **AD9613** is available in a 64-lead LFCSP and is specified over the industrial temperature range of –40°C to +85°C. This product is protected by a U.S. patent.

PRODUCT HIGHLIGHTS

1. Integrated dual, 12-bit, 170 MSPS/210 MSPS/250 MSPS ADCs.
2. Fast overrange and threshold detect.
3. Proprietary differential input maintains excellent SNR performance for input frequencies of up to 400 MHz.
4. SYNC input allows synchronization of multiple devices.
5. 3-pin, 1.8 V SPI port for register programming and register readback.
6. Pin compatibility with the **AD9643**, allowing a simple migration up to 14 bits, and with the **AD6649** and the **AD6643**.

TABLE OF CONTENTS

Features	1	Analog Input Considerations	23
Applications	1	Voltage Reference	25
General Description	1	Clock Input Considerations	25
Functional Block Diagram	1	Power Dissipation and Standby Mode	27
Product Highlights	1	Digital Outputs	27
Revision History	2	ADC Overrange (OR)	27
Specifications	3	Channel/Chip Synchronization	28
ADC DC Specifications	3	Serial Port Interface (SPI)	29
ADC AC Specifications	4	Configuration Using the SPI	29
Digital Specifications	6	Hardware Interface	29
Switching Specifications	8	SPI Accessible Features	30
Timing Specifications	9	Memory Map	31
Absolute Maximum Ratings	11	Reading the Memory Map Register Table	31
Thermal Characteristics	11	Memory Map Register Table	32
ESD Caution	11	Memory Map Register Description	34
Pin Configurations and Function Descriptions	12	Applications Information	35
Typical Performance Characteristics	16	Design Guidelines	35
Equivalent Circuits	22	Outline Dimensions	36
Theory of Operation	23	Ordering Guide	36
ADC Architecture	23		

REVISION HISTORY

2/2017—Rev. C to Rev. D

Changes to Table 9	14
--------------------------	----

1/2013—Rev. B to Rev. C

Changes to Features	1
Changes to Table 1	3
Changes to Table 2	5
Change to Logic Inputs (SDIO) Parameter, Table 3	6
Changes to Table 4	8
Change to Reading the Memory Map Register Table Section	31
Changes to Table 14	33
Change to Memory Map Register Description Section	34
Updated Outline Dimensions	36

9/2011—Rev. A to Rev. B

Changes to Figure 1	1
Changes to Temperature Drift Parameters	3
Changes Output Offset Voltage (V_{OS}), ANSI Mode Typ Parameter and Output Offset Voltage (V_{OS}), Reduced Swing Mode Parameter	7
Changes DCO to Data Skew (t_{SKEW}) Parameters	8

Changes to Output Enable Bar and Power-Down Pin Type and Pin 47 Description	13
Changes to Figure 5 and Pin 7 and Pin 8 Descriptions	14
Changes to Pin 42 and Pin 43, Output Enable Bar and Power-Down Pin Type, and Pin 47 Descriptions	15
Changes to Typical Performance Characteristics Conditions ..	16
Changes to Figure 43	22
Added ADC Overrange (OR) Section	27
Changes to Channel/Chip Synchronization Section	28
Changes to Reading the Memory Map Register Table Section and Transfer Register Map Section	31
Changes to Register 0x02, Bits[5:4]	32
Changes to Register 0x16, Bit 5	33
Added Register 0x3A	34
Deleted Register 0x59	34
Changes to Bit 0—Master Sync Buffer Enable Section	34
Deleted SYNC Pin Control (Register 0x59) Section	34

5/2011—Rev. 0 to Rev. A

Changes to Table 2, AD9613-170: Worst Second or Third Harmonic and Worst Other (Harmonic or Spur) Max Values and Spurious Free Dynamic Range Min Value	4
--	---

4/2011—Revision 0: Initial Version

SPECIFICATIONS

ADC DC SPECIFICATIONS

AVDD = 1.8 V, DRVDD = 1.8 V, maximum sample rate, VIN = -1.0 dBFS differential input, 1.75 V p-p full scale input range, DCS enabled, unless otherwise noted.

Table 1.

Parameter	Temp	AD9613-170			AD9613-210			AD9613-250			Unit
		Min	Typ	Max	Min	Typ	Max	Min	Typ	Max	
RESOLUTION	Full	12			12			12			Bits
ACCURACY		Guaranteed			Guaranteed			Guaranteed			
No Missing Codes	Full										
Offset Error	Full	±10			±10			±10			mV
Gain Error	Full	+2/-6			+3/-5			±4			%FSR
Differential Nonlinearity (DNL)	Full	±0.5			±0.5			±0.5			LSB
Integral Nonlinearity (INL) ¹	25°C	±0.25			±0.25			±0.25			LSB
	Full	±0.5			±0.6			±0.8			LSB
	25°C	±0.20			±0.25			±0.28			LSB
MATCHING CHARACTERISTIC											
Offset Error	Full	±13			±13			±13			mV
Gain Error	Full	±2.5			+3.5/-2			+3.5/-2.5			%FSR
TEMPERATURE DRIFT											
Offset Error	Full	±5			±5			±5			ppm/°C
Gain Error	Full	±70			±80			±100			ppm/°C
INPUT-REFERRED NOISE											
VREF = 1.75 V	25°C	0.39			0.39			0.39			LSB rms
ANALOG INPUT											
Input Span	Full	1.75			1.75			1.75			V p-p
Input Capacitance ²	Full	2.5			2.5			2.5			pF
Input Resistance ³	Full	20			20			20			kΩ
Input Common-Mode Voltage	Full	0.9			0.9			0.9			V
POWER SUPPLIES											
Supply Voltage											
AVDD	Full	1.7	1.8	1.9	1.7	1.8	1.9	1.7	1.8	1.9	V
DRVDD	Full	1.7	1.8	1.9	1.7	1.8	1.9	1.7	1.8	1.9	V
Supply Current											
I _{AVDD} ¹	Full	230 250			241 265			252 275			mA
I _{DRVDD} ¹	Full	142 160			159 185			176 210			mA
POWER CONSUMPTION											
Sine Wave Input ¹ (DRVDD = 1.8 V)	Full	670 738			720 810			770 873			mW
Standby Power ⁴	Full	90			90			90			mW
Power-Down Power	Full	10			10			10			mW

¹ Measured with a low input frequency, full-scale sine wave.

² Input capacitance refers to the effective capacitance between one differential input pin and its complement.

³ Input resistance refers to the effective resistance between one differential input pin and its complement.

⁴ Standby power is measured with a dc input and the CLK± pin inactive (that is, set to AVDD or AGND).

ADC AC SPECIFICATIONS

AVDD = 1.8 V, DRVDD = 1.8 V, maximum sample rate, VIN = -1.0 dBFS differential input, 1.75 V p-p full scale input range, unless otherwise noted.

Table 2.

Parameter ¹	Temp	AD9613-170			AD9613-210			AD9613-250			Unit
		Min	Typ	Max	Min	Typ	Max	Min	Typ	Max	
SIGNAL-TO-NOISE-RATIO (SNR)											
f _{IN} = 30 MHz	25°C		70.1			70.1			70.0		dBFS
f _{IN} = 90 MHz	25°C		70.0			70.0			69.8		dBFS
	Full	69.3			69.2						dBFS
f _{IN} = 140 MHz	25°C		69.8			69.8			69.6		dBFS
f _{IN} = 185 MHz	25°C		69.5			69.5			69.2		dBFS
	Full							67.8			dBFS
f _{IN} = 220 MHz	25°C		69.4			69.3			69.0		dBFS
SIGNAL-TO-NOISE AND DISTORTION (SINAD)											
f _{IN} = 30 MHz	25°C		69.1			69.1			69.0		dBFS
f _{IN} = 90 MHz	25°C		69.0			69.0			68.8		dBFS
	Full	68.2			68						dBFS
f _{IN} = 140 MHz	25°C		68.8			68.8			68.6		dBFS
f _{IN} = 185 MHz	25°C		68.5			68.5			68.2		dBFS
	Full							66.5			dBFS
f _{IN} = 220 MHz	25°C		68.4			68.3			68.0		dBFS
EFFECTIVE NUMBER OF BITS (ENOB)											
f _{IN} = 30 MHz	25°C		11.2			11.2			11.2		Bits
f _{IN} = 90 MHz	25°C		11.2			11.2			11.1		Bits
f _{IN} = 140 MHz	25°C		11.1			11.1			11.1		Bits
f _{IN} = 185 MHz	25°C		11.1			11.1			11.0		Bits
f _{IN} = 220 MHz	25°C		11.1			11.0			11.0		Bits
WORST SECOND OR THIRD HARMONIC											
f _{IN} = 30 MHz	25°C		-94			-94			-90		dBc
f _{IN} = 90 MHz	25°C		-92			-94			-89		dBc
	Full			-78			-80				dBc
f _{IN} = 140 MHz	25°C		-87			-88			-86		dBc
f _{IN} = 185 MHz	25°C		-89			-83			-86		dBc
	Full								-80		dBc
f _{IN} = 220 MHz	25°C		-80			-83			-85		dBc
SPURIOUS-FREE DYNAMIC RANGE (SFDR)											
f _{IN} = 30 MHz	25°C		94			90			92		dBc
f _{IN} = 90 MHz	25°C		92			90			89		dBc
	Full	78			80						dBc
f _{IN} = 140 MHz	25°C		87			88			86		dBc
f _{IN} = 185 MHz	25°C		89			83			86		dBc
	Full							80			dBc
f _{IN} = 220 MHz	25°C		83			83			85		dBc
WORST OTHER (HARMONIC OR SPUR)											
f _{IN} = 30 MHz	25°C		-97			-95			-93		dBc
f _{IN} = 90 MHz	25°C		-96			-95			-92		dBc
	Full			-78			-80				dBc
f _{IN} = 140 MHz	25°C		-97			-97			-91		dBc
f _{IN} = 185 MHz	25°C		-91			-96			-91		dBc
	Full								-80		dBc
f _{IN} = 220 MHz	25°C		-93			-94			-89		dBc

Parameter ¹	Temp	AD9613-170			AD9613-210			AD9613-250			Unit
		Min	Typ	Max	Min	Typ	Max	Min	Typ	Max	
TWO-TONE SFDR f _{IN} = 184.12 MHz (−7 dBFS), 187.12 MHz (−7 dBFS)	25°C		88			88			88		dBc
CROSSTALK ²	Full		95			95			95		dB
FULL POWER BANDWIDTH ³	25°C		1000			1000			1000		MHz

¹ See the [AN-835](#) Application Note, *Understanding High Speed ADC Testing and Evaluation*, for a complete set of definitions.

² Crosstalk is measured at 100 MHz with −1.0 dBFS on one channel and no input on the alternate channel.

³ Full power bandwidth is the bandwidth of operation where typical ADC performance can be achieved.

DIGITAL SPECIFICATIONS

AVDD = 1.8 V, DRVDD = 1.8 V, maximum sample rate, VIN = -1.0 dBFS differential input, 1.75 V p-p full-scale input range, DCS enabled, unless otherwise noted.

Table 3.

Parameter	Temp	Min	Typ	Max	Unit
DIFFERENTIAL CLOCK INPUTS (CLK+, CLK-)					
Logic Compliance		CMOS/LVDS/LVPECL			
Internal Common-Mode Bias	Full		0.9		V
Differential Input Voltage	Full	0.3		3.6	V p-p
Input Voltage Range	Full	AGND		AVDD	V
Input Common-Mode Range	Full	0.9		1.4	V
High Level Input Current	Full	10		22	μA
Low Level Input Current	Full	-22		-10	μA
Input Capacitance	Full		4		pF
Input Resistance	Full	8	10	12	kΩ
SYNC INPUT					
Logic Compliance		CMOS/LVDS			
Internal Bias	Full		0.9		V
Input Voltage Range	Full	AGND		AVDD	V
High Level Input Voltage	Full	1.2		AVDD	V
Low Level Input Voltage	Full	AGND		0.6	V
High Level Input Current	Full	-5		+5	μA
Low Level Input Current	Full	-5		+5	μA
Input Capacitance	Full		1		pF
Input Resistance	Full	12	16	20	kΩ
LOGIC INPUT (CSB)¹					
High Level Input Voltage	Full	1.22		2.1	V
Low Level Input Voltage	Full	0		0.6	V
High Level Input Current	Full	-5		+5	μA
Low Level Input Current	Full	-80		+45	μA
Input Resistance	Full		26		kΩ
Input Capacitance	Full		2		pF
LOGIC INPUT (SCLK)²					
High Level Input Voltage	Full	1.22		2.1	V
Low Level Input Voltage	Full	0		0.6	V
High Level Input Current	Full	45		70	μA
Low Level Input Current	Full	-5		+5	μA
Input Resistance	Full		26		kΩ
Input Capacitance	Full		2		pF
LOGIC INPUTS (SDIO)²					
High Level Input Voltage	Full	1.22		2.1	V
Low Level Input Voltage	Full	0		0.6	V
High Level Input Current	Full	45		70	μA
Low Level Input Current	Full	-5		+5	μA
Input Resistance	Full		26		kΩ
Input Capacitance	Full		5		pF

Parameter	Temp	Min	Typ	Max	Unit
LOGIC INPUTS (OEB, PDWN) ²					
High Level Input Voltage	Full	1.22		2.1	V
Low Level Input Voltage	Full	0		0.6	V
High Level Input Current	Full	45		70	μA
Low Level Input Current	Full	-5		+5	μA
Input Resistance	Full		26		kΩ
Input Capacitance	Full		5		pF
DIGITAL OUTPUTS					
LVDS Data and OR Outputs					
Differential Output Voltage (V_{OD}), ANSI Mode	Full	250	350	450	mV
Output Offset Voltage (V_{OS}), ANSI Mode	Full	1.15	1.22	1.35	V
Differential Output Voltage (V_{OD}), Reduced Swing Mode	Full	150	200	280	mV
Output Offset Voltage (V_{OS}), Reduced Swing Mode	Full	1.15	1.22	1.35	V

¹ Pull up.

² Pull down.

SWITCHING SPECIFICATIONS

Table 4.

Parameter	Temp	AD9613-170			AD9613-210			AD9613-250			Unit
		Min	Typ	Max	Min	Typ	Max	Min	Typ	Max	
CLOCK INPUT PARAMETERS											
Input Clock Rate	Full			625			625			625	MHz
Conversion Rate ¹	Full	40		170	40		210	40		250	MSPS
CLK Period, Divide-by-1 Mode (t _{CLK})	Full	5.8			4.8			4			ns
CLK Pulse Width High (t _{CH})											
Divide-by-1 Mode, DCS Enabled	Full	2.61	2.9	3.19	2.16	2.4	2.64	1.8	2.0	2.2	ns
Divide-by-1 Mode, DCS Disabled	Full	2.76	2.9	3.05	2.28	2.4	2.52	1.9	2.0	2.1	ns
Divide-by-2 Mode Through Divide-by-8 Mode	Full	0.8			0.8			0.8			ns
Aperture Delay (t _A)	Full		1.0			1.0			1.0		ns
Aperture Uncertainty (Jitter, t _J)	Full		0.1			0.1			0.1		ps rms
DATA OUTPUT PARAMETERS											
LVDS Mode											
Data Propagation Delay (t _{PD})	Full		6.0			6.0			6.0		ns
DCO Propagation Delay (t _{DCO})	Full		6.7			6.7			6.7		ns
DCO to Data Skew (t _{SKEW})	Full	0.4	0.7	1.0	0.4	0.7	1.0	0.4	0.7	1.0	ns
Pipeline Delay (Latency)	Full		10			10			10		Cycles
Aperture Delay (t _A)	Full		1.0			1.0			1.0		ns
Aperture Uncertainty (Jitter, t _J)	Full		0.1			0.1			0.1		ps rms
Wake-Up Time (from Standby)	Full		10			10			10		μs
Wake-Up Time (from Power Down)	Full		250			250			250		μs
Out-of-Range Recovery Time	Full			3		3			3		Cycles

¹ Conversion rate is the clock rate after the divider.

TIMING SPECIFICATIONS

Table 5.

Parameter	Test Conditions/Comments	Min	Typ	Max	Unit
SYNC TIMING REQUIREMENTS	See Figure 3 for timing details				
t _{SSYNC}	SYNC to the rising edge of CLK setup time		0.3		ns
t _{HSYNC}	SYNC to the rising edge of CLK hold time		0.4		ns
SPI TIMING REQUIREMENTS	See Figure 58 for SPI timing diagram				
t _{DS}	Setup time between the data and the rising edge of SCLK	2			ns
t _{DH}	Hold time between the data and the rising edge of SCLK	2			ns
t _{CLK}	Period of the SCLK	40			ns
t _S	Setup time between CSB and SCLK	2			ns
t _H	Hold time between CSB and SCLK	2			ns
t _{HIGH}	Minimum period that SCLK should be in a logic high state	10			ns
t _{LOW}	Minimum period that SCLK should be in a logic low state	10			ns
t _{EN_SDIO}	Time required for the SDIO pin to switch from an input to an output relative to the SCLK falling edge (not shown in Figure 58)	10			ns
t _{DIS_SDIO}	Time required for the SDIO pin to switch from an output to an input relative to the SCLK rising edge (not shown in Figure 58)	10			ns

Timing Diagrams

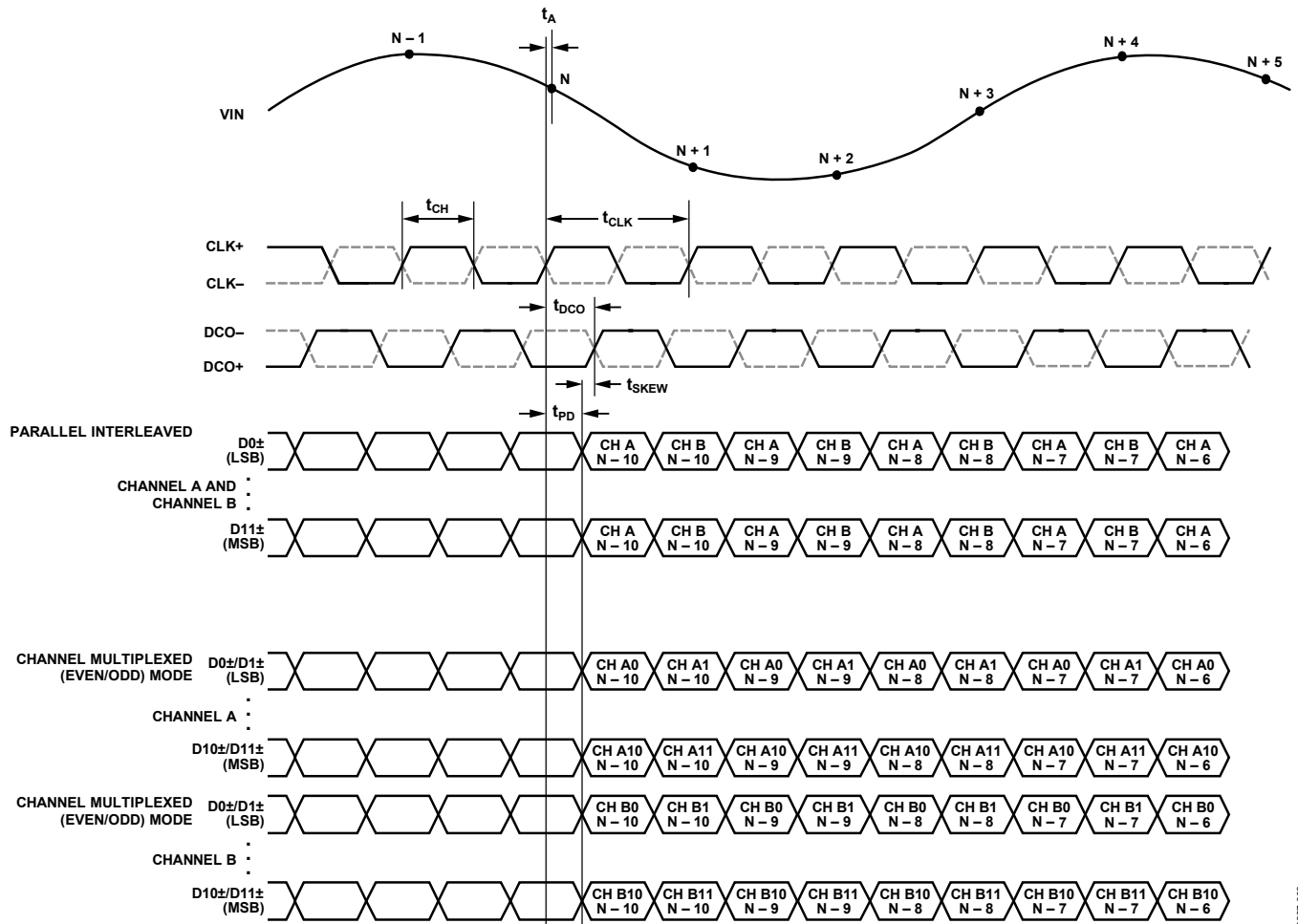

Figure 2. Interleaved LVDS Mode Data Output Timing

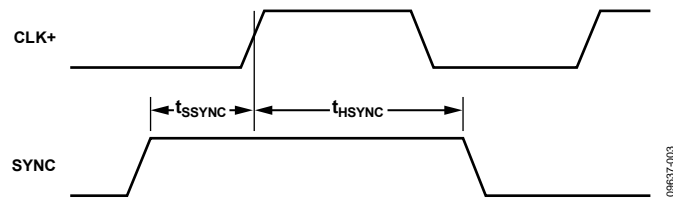

Figure 3. SYNC Timing Inputs

ABSOLUTE MAXIMUM RATINGS

Table 6.

Parameter	Rating
Electrical	
AVDD to AGND	−0.3 V to +2.0 V
DRVDD to AGND	−0.3 V to +2.0 V
VIN+A/VIN+B, VIN−A/VIN−B to AGND	−0.3 V to AVDD + 0.2 V
CLK+, CLK− to AGND	−0.3 V to AVDD + 0.2 V
SYNC to AGND	−0.3 V to AVDD + 0.2 V
VCM to AGND	−0.3 V to AVDD + 0.2 V
CSB to AGND	−0.3 V to DRVDD + 0.3 V
SCLK to AGND	−0.3 V to DRVDD + 0.3 V
SDIO to AGND	−0.3 V to DRVDD + 0.3 V
OEB to AGND	−0.3 V to DRVDD + 0.3 V
PDWN to AGND	−0.3 V to DRVDD + 0.3 V
OR+/OR− to AGND	−0.3 V to DRVDD + 0.3 V
D0−/D0+ Through D11−/D11+ to AGND	−0.3 V to DRVDD + 0.3 V
DCO+/DCO− to AGND	−0.3 V to DRVDD + 0.3 V
Environmental	
Operating Temperature Range (Ambient)	−40°C to +85°C
Maximum Junction Temperature Under Bias	150°C
Storage Temperature Range (Ambient)	−65°C to +125°C

Stresses at or above those listed under Absolute Maximum Ratings may cause permanent damage to the product. This is a stress rating only; functional operation of the product at these or any other conditions above those indicated in the operational section of this specification is not implied. Operation beyond the maximum operating conditions for extended periods may affect product reliability.

THERMAL CHARACTERISTICS

The exposed paddle must be soldered to the ground plane for the LFCSP package. Soldering the exposed paddle to the printed circuit board (PCB) increases the reliability of the solder joints, maximizing the thermal capability of the package.

Typical θ_{JA} is specified for a 4-layer PCB with solid ground plane. As shown in Figure 40, airflow increases heat dissipation, which reduces θ_{JA} . In addition, metal in direct contact with the package leads from metal traces, through holes, ground, and power planes reduces the θ_{JA} .

Table 7. Thermal Resistance

Package Type	Airflow Velocity (m/sec)	$\theta_{JA}^{1,2}$	$\theta_{JC}^{1,3}$	$\theta_{JB}^{1,4}$	Unit
64-Lead LFCSP 9 mm × 9 mm (CP-64-4)	0	26.8	1.14	10.4	°C/W
	1.0	21.6			°C/W
	2.0	20.2			°C/W

¹ Per JEDEC 51-7, plus JEDEC 25-5 2S2P test board.

² Per JEDEC JESD51-2 (still air) or JEDEC JESD51-6 (moving air).

³ Per MIL-Std 883, Method 1012.1.

⁴ Per JEDEC JESD51-8 (still air).

ESD CAUTION



ESD (electrostatic discharge) sensitive device. Charged devices and circuit boards can discharge without detection. Although this product features patented or proprietary protection circuitry, damage may occur on devices subjected to high energy ESD. Therefore, proper ESD precautions should be taken to avoid performance degradation or loss of functionality.

PIN CONFIGURATIONS AND FUNCTION DESCRIPTIONS

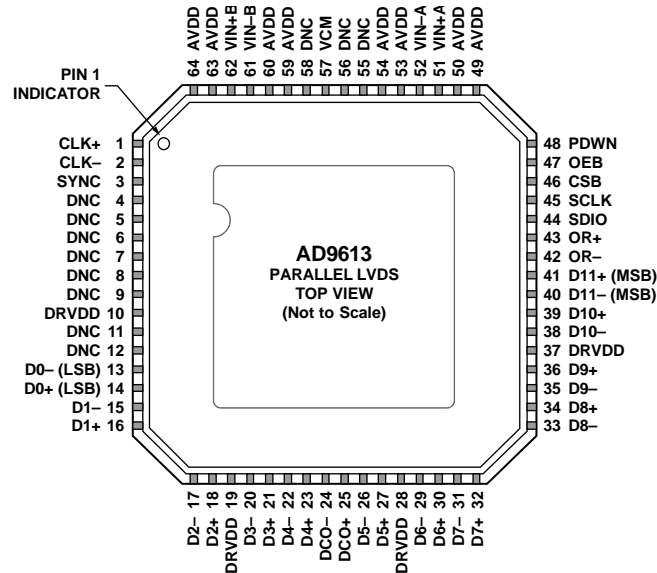

NOTES

1. DNC = DO NOT CONNECT. DO NOT CONNECT TO THIS PIN.
2. THE EXPOSED THERMAL PADDLE ON THE BOTTOM OF THE PACKAGE PROVIDES THE ANALOG GROUND FOR THE PART. THIS EXPOSED PADDLE MUST BE CONNECTED TO GROUND FOR PROPER OPERATION.

09837-004

Figure 4. Pin Configuration (Top View) for the LFCSP Interleaved Parallel LVDS Mode

Table 8. Pin Function Descriptions for the LFCSP Interleaved Parallel LVDS Mode

Pin No.	Mnemonic	Type	Description
ADC Power Supplies			
0	AGND, Exposed Paddle	Ground	Analog Ground. The exposed thermal paddle on the bottom of the package provides the analog ground for the part. This exposed paddle must be connected to ground for proper operation.
4 to 9, 11, 12, 55, 56, 58	DNC		Do not connect. Do not connect to these pins.
10, 19, 28, 37	DRVDD	Supply	Digital Output Driver Supply (1.8 V Nominal).
49, 50, 53, 54, 59, 60, 63, 64	AVDD	Supply	Analog Power Supply (1.8 V Nominal).
ADC Analog			
1	CLK+	Input	ADC Clock Input—True.
2	CLK-	Input	ADC Clock Input—Complement.
51	VIN+A	Input	Differential Analog Input Pin (+) for Channel A.
52	VIN-A	Input	Differential Analog Input Pin (-) for Channel A.
57	VCM	Output	Common-Mode Level Bias Output for Analog Inputs. This pin should be decoupled to ground using a 0.1 μ F capacitor.
61	VIN-B	Input	Differential Analog Input Pin (-) for Channel B.
62	VIN+B	Input	Differential Analog Input Pin (+) for Channel B.
Digital Input			
3	SYNC	Input	Digital Synchronization Pin. Slave mode only.

Pin No.	Mnemonic	Type	Description
Digital Outputs			
14	D0+ (LSB)	Output	Channel A/Channel B LVDS Output Data 0—True.
13	D0– (LSB)	Output	Channel A/Channel B LVDS Output Data 0—Complement.
16	D1+	Output	Channel A/Channel B LVDS Output Data 1—True.
15	D1–	Output	Channel A/Channel B LVDS Output Data 1—Complement.
18	D2+	Output	Channel A/Channel B LVDS Output Data 2—True.
17	D2–	Output	Channel A/Channel B LVDS Output Data 2—Complement.
21	D3+	Output	Channel A/Channel B LVDS Output Data 3—True.
20	D3–	Output	Channel A/Channel B LVDS Output Data 3—Complement.
23	D4+	Output	Channel A/Channel B LVDS Output Data 4—True.
22	D4–	Output	Channel A/Channel B LVDS Output Data 4—Complement.
27	D5+	Output	Channel A/Channel B LVDS Output Data 5—True.
26	D5–	Output	Channel A/Channel B LVDS Output Data 5—Complement.
30	D6+	Output	Channel A/Channel B LVDS Output Data 6—True.
29	D6–	Output	Channel A/Channel B LVDS Output Data 6—Complement.
32	D7+	Output	Channel A/Channel B LVDS Output Data 7—True.
31	D7–	Output	Channel A/Channel B LVDS Output Data 7—Complement.
34	D8+	Output	Channel A/Channel B LVDS Output Data 8—True.
33	D8–	Output	Channel A/Channel B LVDS Output Data 8—Complement.
36	D9+	Output	Channel A/Channel B LVDS Output Data 9—True.
35	D9–	Output	Channel A/Channel B LVDS Output Data 9—Complement.
39	D10+	Output	Channel A/Channel B LVDS Output Data 10—True.
38	D10–	Output	Channel A/Channel B LVDS Output Data 10—Complement.
41	D11+ (MSB)	Output	Channel A/Channel B LVDS Output Data 11—True.
40	D11– (MSB)	Output	Channel A/Channel B LVDS Output Data 11—Complement.
43	OR+	Output	Channel A/Channel B LVDS Overage—True.
42	OR–	Output	Channel A/Channel B LVDS Overage—Complement.
25	DCO+	Output	Channel A/Channel B LVDS Data Clock Output—True.
24	DCO–	Output	Channel A/Channel B LVDS Data Clock Output—Complement.
SPI Control			
45	SCLK	Input	SPI Serial Clock.
44	SDIO	Input/Output	SPI Serial Data I/O.
46	CSB	Input	SPI Chip Select (Active Low).
Output Enable Bar and Power-Down			
47	OEB	Input/Output	Output Enable Bar Input (Active Low).
48	PDWN	Input/Output	Power-Down Input (Active High). Operation depends upon SPI mode; this input can be configured as power-down or standby. For further description, refer to Table 14.

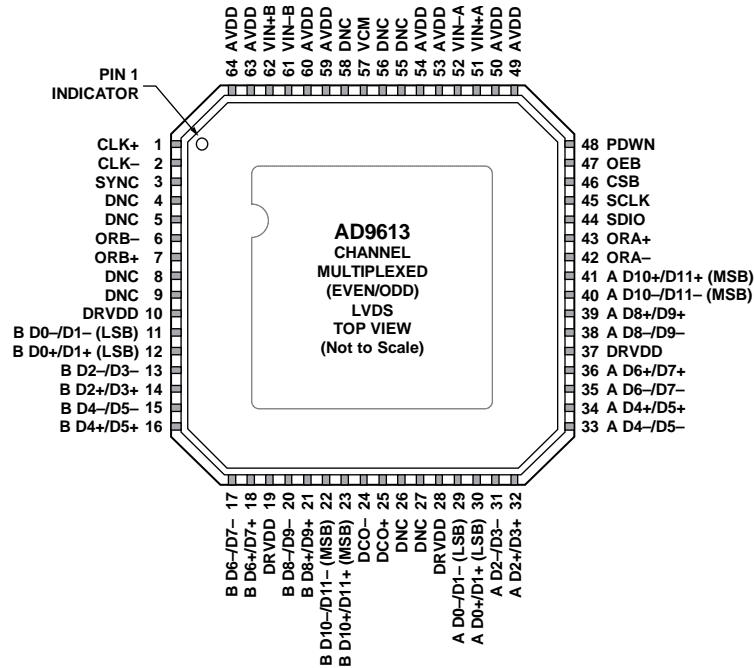

- NOTES**
1. DNC = DO NOT CONNECT. DO NOT CONNECT TO THIS PIN.
 2. THE EXPOSED THERMAL PADDLE ON THE BOTTOM OF THE PACKAGE PROVIDES THE ANALOG GROUND FOR THE PART. THIS EXPOSED PADDLE MUST BE CONNECTED TO GROUND FOR PROPER OPERATION.

09637-005

Figure 5. Pin Configuration (Top View) for the LFCSP Channel Multiplexed (Even/Odd) LVDS Mode

Table 9. Pin Function Descriptions for the LFCSP Channel Multiplexed (Even/Odd) LVDS Mode

Pin No.	Mnemonic	Type	Description
ADC Power Supplies 10, 19, 28, 37 49, 50, 53, 54, 59, 60, 63, 64 4, 5, 8, 9, 26, 27, 55, 56, 58 0	DRVDD AVDD DNC AGND, Exposed Paddle	Supply Supply Ground	Digital Output Driver Supply (1.8 V Nominal). Analog Power Supply (1.8 V Nominal). Do Not Connect. Do not connect to these pins. The exposed thermal paddle on the bottom of the package provides the analog ground for the part. This exposed paddle must be connected to ground for proper operation.
ADC Analog 51 52 62 61 57 1 2	VIN+A VIN-A VIN+B VIN-B VCM CLK+ CLK-	Input Input Input Input Output Input Input	Differential Analog Input Pin (+) for Channel A. Differential Analog Input Pin (-) for Channel A. Differential Analog Input Pin (+) for Channel B. Differential Analog Input Pin (-) for Channel B. Common-Mode Level Bias Output for Analog Inputs. This pin should be decoupled to ground using a 0.1 μ F capacitor. ADC Clock Input—True. ADC Clock Input—Complement.
Digital Input 3	SYNC	Input	Digital Synchronization Pin. Slave mode only.
Digital Outputs 7 6	ORB+ ORB-	Output Output	Channel B LVDS Overrange Output—True. The overrange indication is valid on the rising edge of the DCO. Channel B LVDS Overrange Output—Complement. The overrange indication is valid on the rising edge of the DCO.

Pin No.	Mnemonic	Type	Description
11	B D0-/D1- (LSB)	Output	Channel B LVDS Output Data 1/Data 0—Complement.
12	B D0+/D1+ (LSB)	Output	Channel B LVDS Output Data 1/Data 0—True.
13	B D2-/D3-	Output	Channel B LVDS Output Data 3/Data 2—Complement.
14	B D2+/D3+	Output	Channel B LVDS Output Data 3/Data 2—True.
15	B D4-/D5-	Output	Channel B LVDS Output Data 5/Data 4—Complement.
16	B D4+/D5+	Output	Channel B LVDS Output Data 5/Data 4—True.
17	B D6-/D7-	Output	Channel B LVDS Output Data 7/Data 6—Complement.
18	B D6+/D7+	Output	Channel B LVDS Output Data 7/Data 6—True.
20	B D8-/D9-	Output	Channel B LVDS Output Data 9/Data 8—Complement.
21	B D8+/D9+	Output	Channel B LVDS Output Data 9/Data 8—True.
22	B D10-/D11-	Output	Channel B LVDS Output Data 11/Data 10—Complement.
23	B D10+/D11+	Output	Channel B LVDS Output Data 11/Data 10—True.
29	A D0-/D1- (LSB)	Output	Channel A LVDS Output Data 1/Data 0—Complement.
30	A D0+/D1+ (LSB)	Output	Channel A LVDS Output Data 1/Data 0—True.
31	A D2-/D3-	Output	Channel A LVDS Output Data 3/Data 2—Complement.
32	A D2+/D3+	Output	Channel A LVDS Output Data 3/Data 2—True.
33	A D4-/D5-	Output	Channel A LVDS Output Data 5/Data 4—Complement.
34	A D4+/D5+	Output	Channel A LVDS Output Data 5/Data 4—True.
35	A D6-/D7-	Output	Channel A LVDS Output Data 7/Data 6—Complement.
36	A D6+/D7+	Output	Channel A LVDS Output Data 7/Data 6—True.
38	A D8-/D9-	Output	Channel A LVDS Output Data 9/Data 8—Complement.
39	A D8+/D9+	Output	Channel A LVDS Output Data 9/Data 8—True.
40	A D10-/D11-	Output	Channel A LVDS Output Data 11/Data 10—Complement.
41	A D10+/D11+	Output	Channel A LVDS Output Data 11/Data 10—True.
43	ORA+	Output	Channel A LVDS Overage Output—True. The overrange indication is valid on the rising edge of the DCO.
42	ORA-	Output	Channel A LVDS Overage Output—Complement. The overrange indication is valid on the rising edge of the DCO.
25	DCO+	Output	Channel A/Channel B LVDS Data Clock Output—True.
24	DCO-	Output	Channel A/Channel B LVDS Data Clock Output—Complement.
SPI Control			
45	SCLK	Input	SPI Serial Clock.
44	SDIO	Input/Output	SPI Serial Data I/O.
46	CSB	Input	SPI Chip Select (Active Low).
Output Enable Bar and Power-Down			
47	OEB	Input	Output Enable Bar Input (Active Low).
48	PDWN	Input	Power-Down Input (Active High). Operation depends upon SPI mode; this input can be configured as power-down or standby. For further description, refer to Table 14.

TYPICAL PERFORMANCE CHARACTERISTICS

AVDD = 1.8 V, DRVDD = 1.8 V, sample rate = maximum sample rate per speed grade, DCS enabled, 1.75 V p-p differential input, VIN = -1.0 dBFS, 32k sample, TA = 25°C, unless otherwise noted.

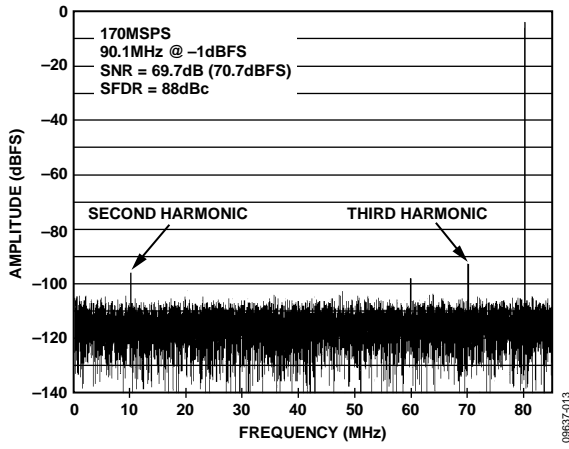

Figure 6. AD9613-170 Single-Tone FFT with $f_{IN} = 90.1$ MHz

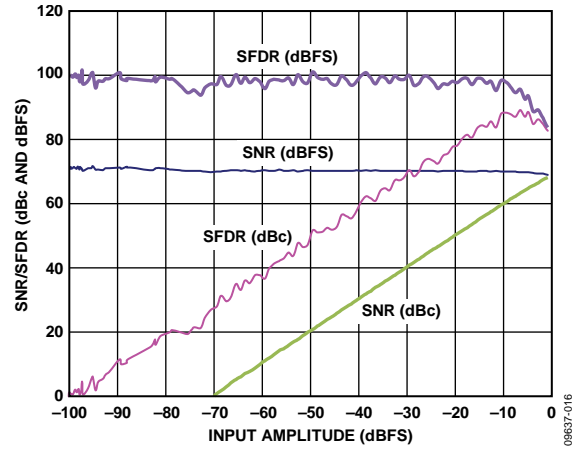

Figure 9. AD9613-170 Single-Tone SNR/SFDR vs. Input Amplitude (A_{IN}) with $f_{IN} = 90.1$ MHz

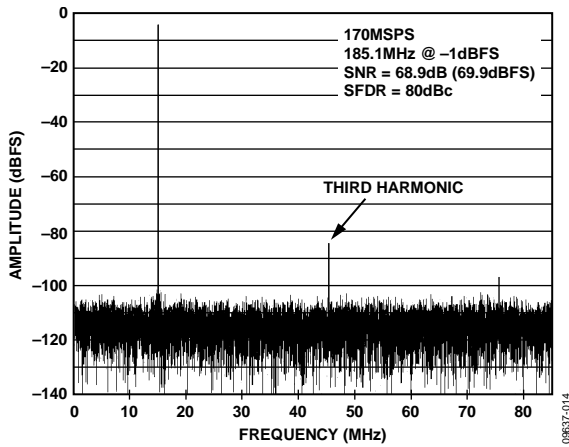

Figure 7. AD9613-170 Single-Tone FFT with $f_{IN} = 185.1$ MHz

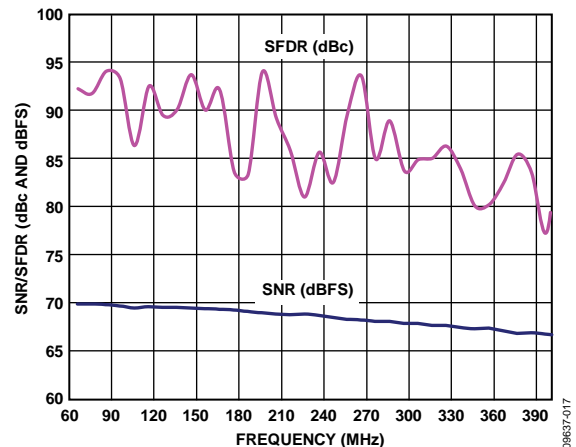

Figure 10. AD9613-170 Single-Tone SNR/SFDR vs. Input Frequency (f_{IN})

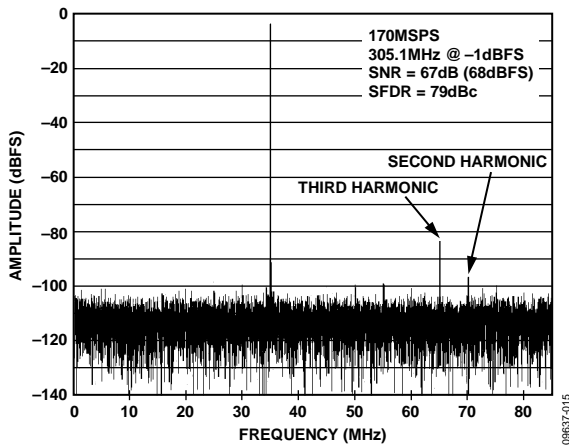

Figure 8. AD9613-170 Single-Tone FFT with $f_{IN} = 305.1$ MHz

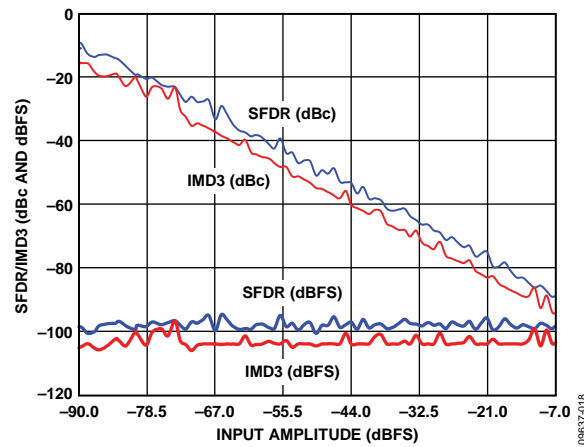

Figure 11. AD9613-170 Two-Tone SFDR/IMD3 vs. Input Amplitude (A_{IN}) with $f_{IN1} = 89.12$, $f_{IN2} = 92.12$ MHz, $f_s = 170$ MSPS

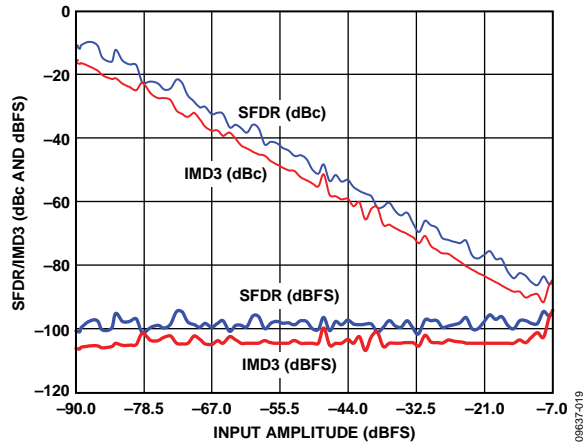

Figure 12. AD9613-170 Two-Tone SFDR/IMD3 vs. Input Amplitude (A_{IN}) with $f_{IN1} = 184.12$, $f_{IN2} = 187.12$ MHz, $f_s = 170$ MSPS

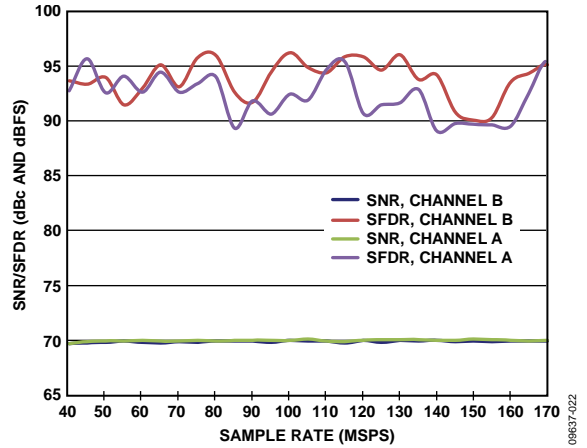

Figure 15. AD9613-170 Single-Tone SNR/SFDR vs. Sample Rate (f_s) with $f_{IN} = 90$ MHz

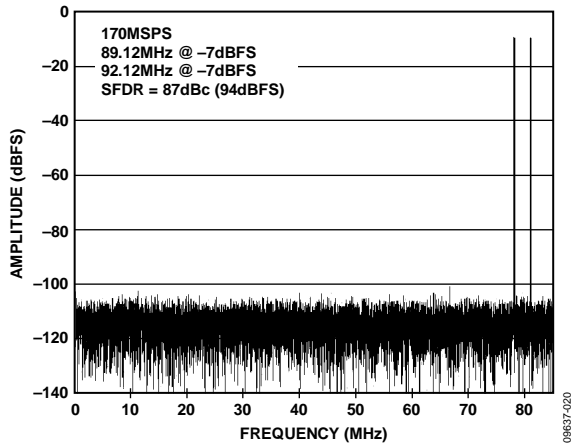

Figure 13. AD9613-170 Two-Tone FFT with $f_{IN1} = 89.12$, $f_{IN2} = 92.12$ MHz, $f_s = 170$ MSPS

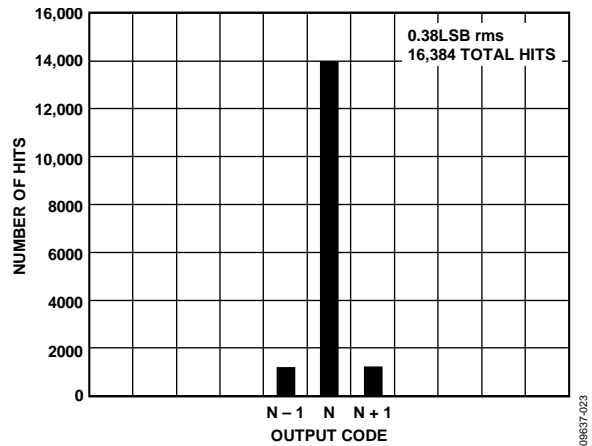

Figure 16. AD9613-170 Grounded Input Histogram

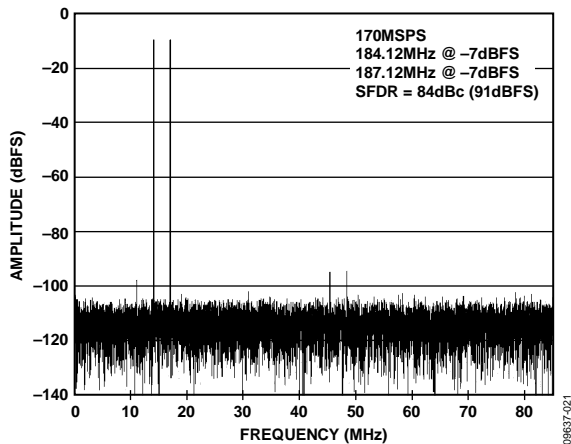

Figure 14. AD9613-170 Two-Tone FFT with $f_{IN1} = 184.12$, $f_{IN2} = 187.12$ MHz, $f_s = 170$ MSPS

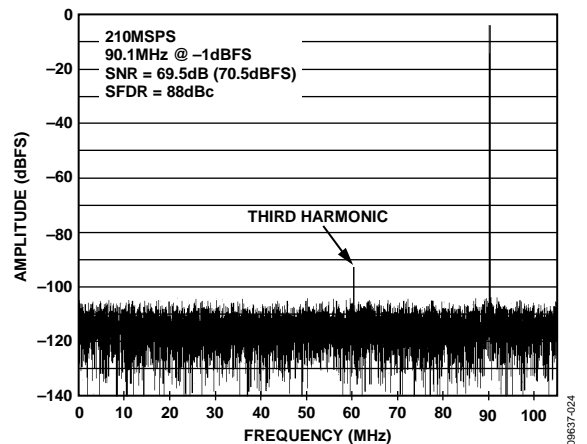

Figure 17. AD9613-210 Single-Tone FFT with $f_{IN} = 90.1$ MHz

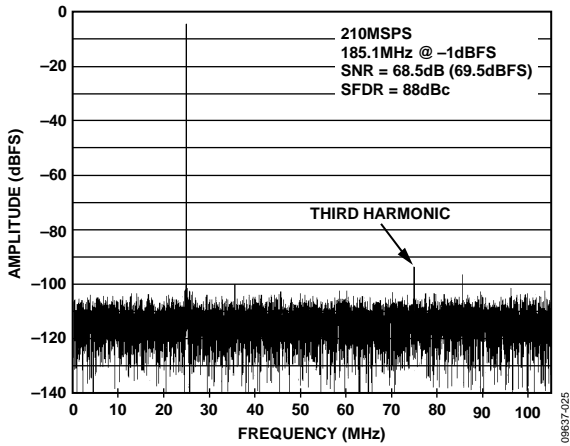

Figure 18. AD9613-210 Single-Tone FFT with $f_{IN} = 185.1$ MHz

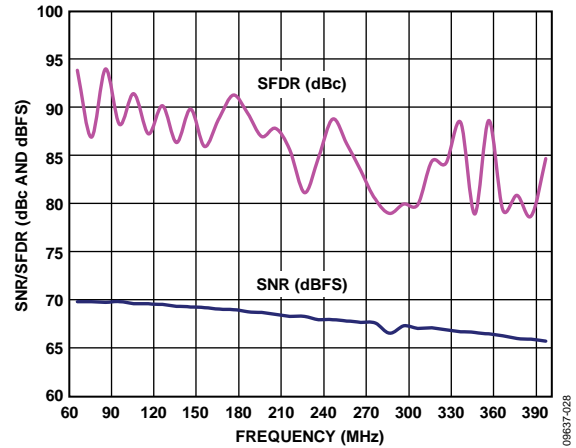

Figure 21. AD9613-210 Single-Tone SNR/SFDR vs. Input Frequency (f_{IN})

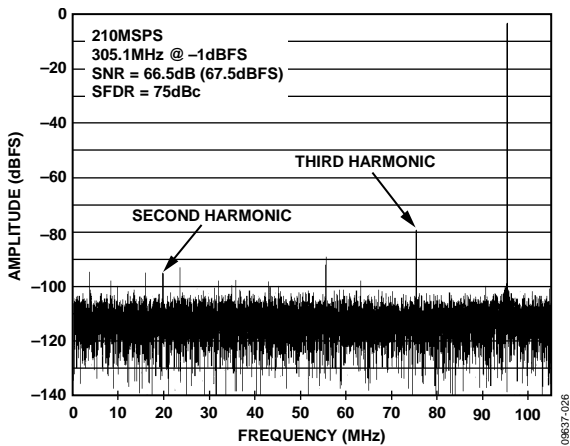

Figure 19. AD9613-210 Single-Tone FFT with $f_{IN} = 305.1$ MHz

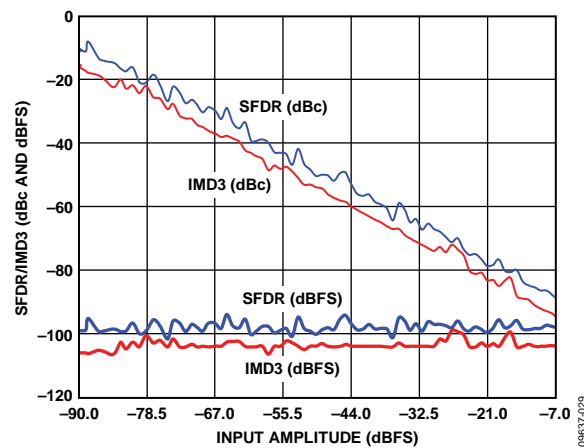

Figure 22. AD9613-210 Two-Tone SFDR/IMD3 vs. Input Amplitude (A_{IN}) with $f_{IN1} = 89.12$, $f_{IN2} = 92.12$ MHz, $f_s = 210$ MSPS

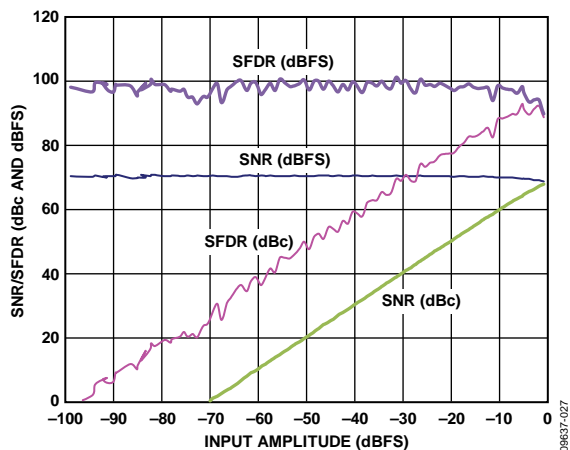

Figure 20. AD9613-210 Single-Tone SNR/SFDR vs. Input Amplitude (A_{IN}) with $f_{IN} = 90.1$ MHz

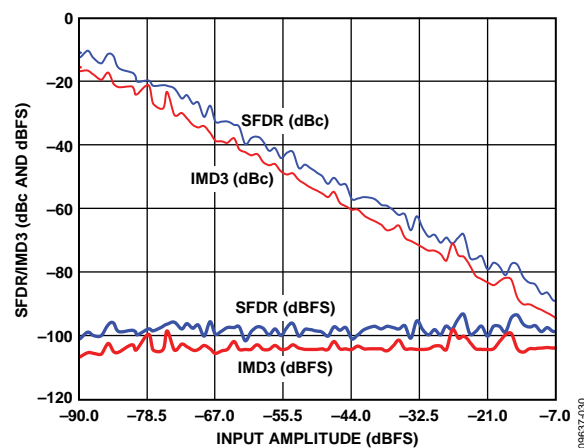

Figure 23. AD9613-210 Two-Tone SFDR/IMD3 vs. Input Amplitude (A_{IN}) with $f_{IN1} = 184.12$, $f_{IN2} = 187.12$ MHz, $f_s = 210$ MSPS

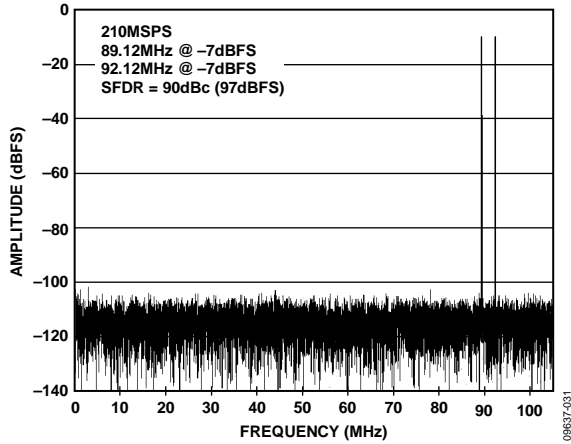

Figure 24. AD9613-210 Two-Tone FFT with $f_{IN1} = 89.12$, $f_{IN2} = 92.12$ MHz, $f_s = 210$ MSPS

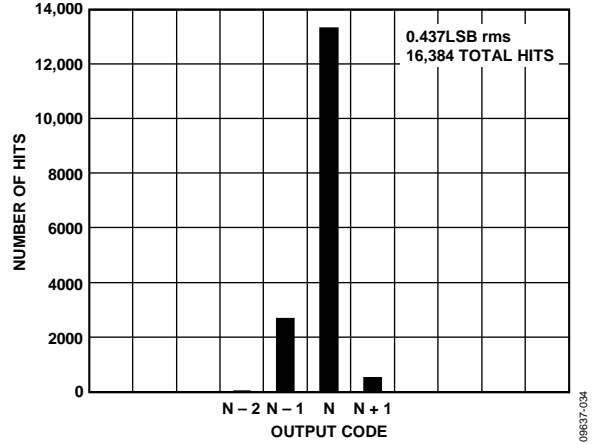

Figure 27. AD9613-210 Grounded Input Histogram

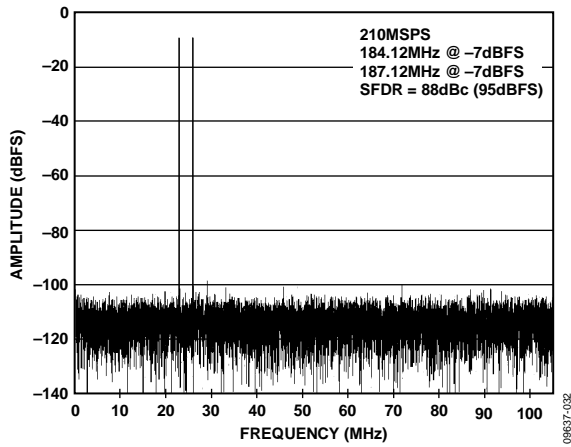

Figure 25. AD9613-210 Two-Tone FFT with $f_{IN1} = 184.12$, $f_{IN2} = 187.12$ MHz, $f_s = 210$ MSPS

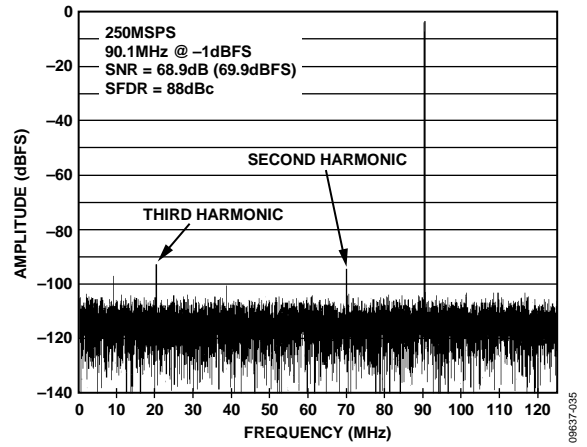

Figure 28. AD9613-250 Single-Tone FFT with $f_{IN} = 90.1$ MHz

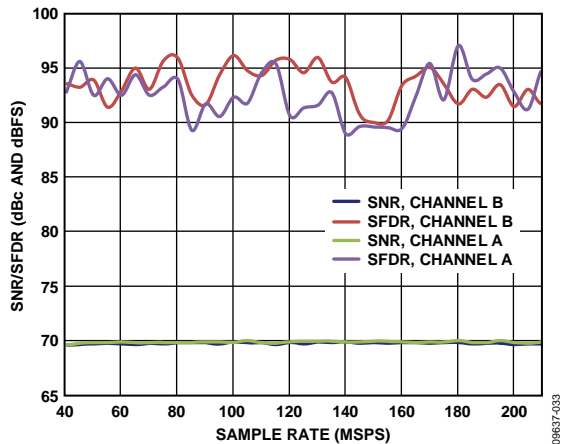

Figure 26. AD9613-210 Single-Tone SNR/SFDR vs. Sample Rate (f_s) with $f_{IN} = 90$ MHz

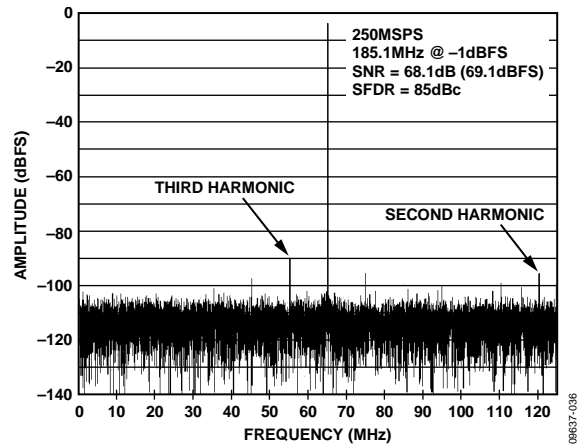

Figure 29. AD9613-250 Single-Tone FFT with $f_{IN} = 185.1$ MHz

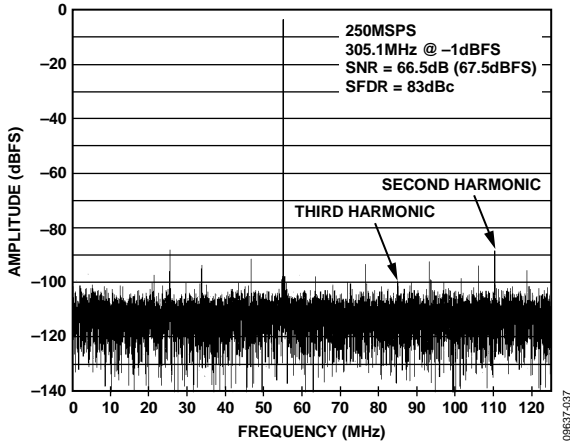

Figure 30. AD9613-250 Single-Tone FFT with $f_{IN} = 305.1$ MHz

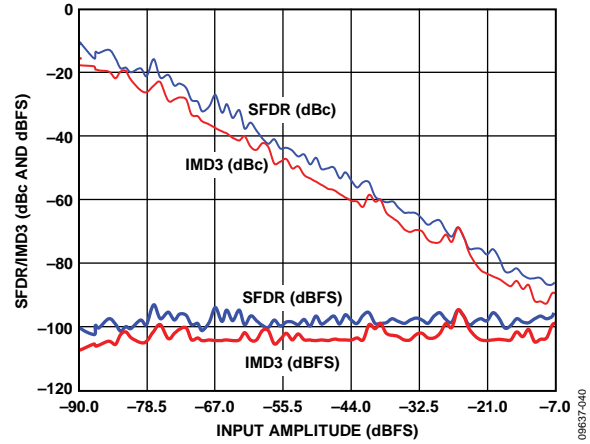

Figure 33. AD9613-250 Two-Tone SFDR/IMD3 vs. Input Amplitude (A_{IN}) with $f_{IN1} = 89.12$, $f_{IN2} = 92.12$ MHz, $f_s = 250$ MSPS

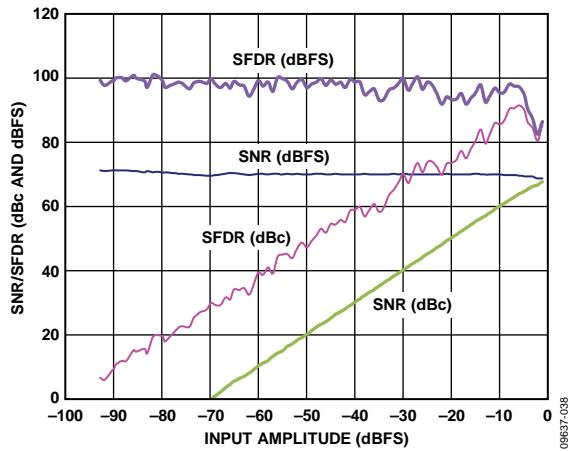

Figure 31. AD9613-250 Single-Tone SNR/SFDR vs. Input Amplitude (A_{IN}) with $f_{IN} = 90.1$ MHz

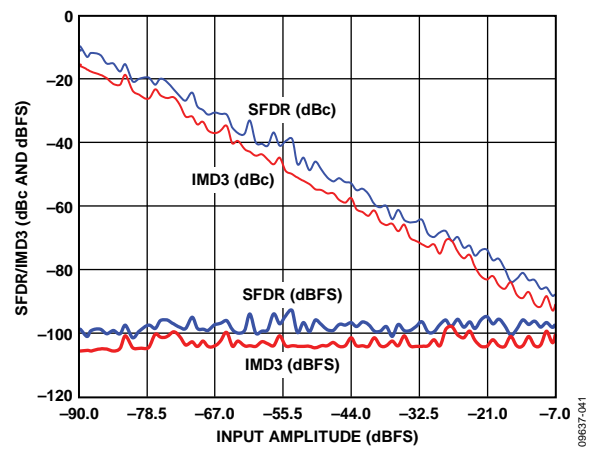

Figure 34. AD9613-250 Two-Tone SFDR/IMD3 vs. Input Amplitude (A_{IN}) with $f_{IN1} = 184.12$, $f_{IN2} = 187.12$ MHz, $f_s = 250$ MSPS

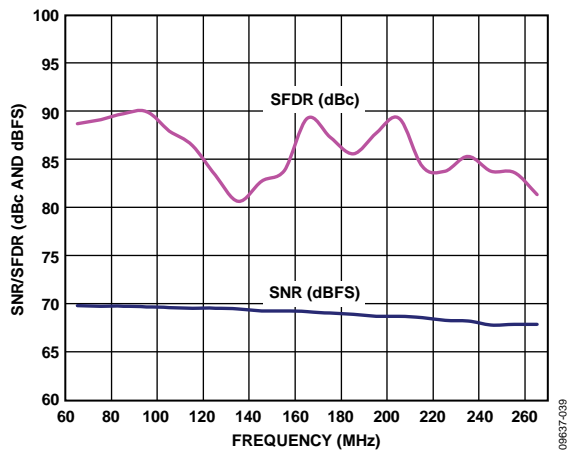

Figure 32. AD9613-250 Single-Tone SNR/SFDR vs. Input Frequency (f_{IN})

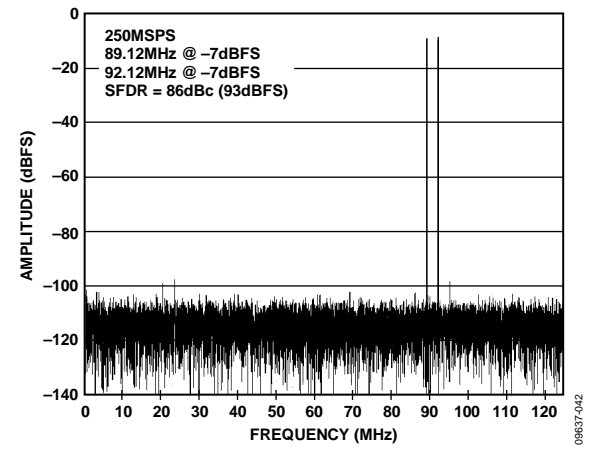

Figure 35. AD9613-250 Two-Tone FFT with $f_{IN1} = 89.12$, $f_{IN2} = 92.12$ MHz, $f_s = 250$ MSPS

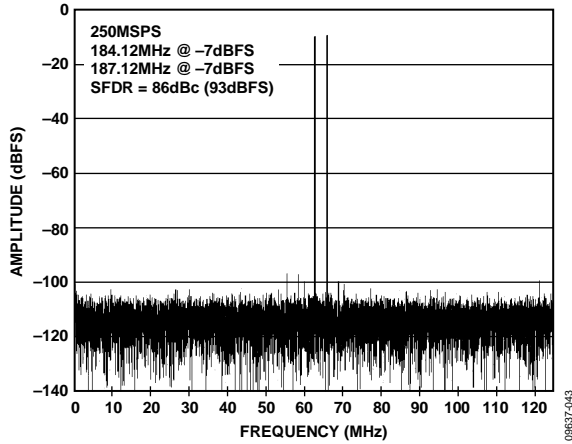

Figure 36. AD9613-250 Two-Tone FFT with $f_{IN1} = 184.12$, $f_{IN2} = 187.12$ MHz, $f_s = 250$ MSPS

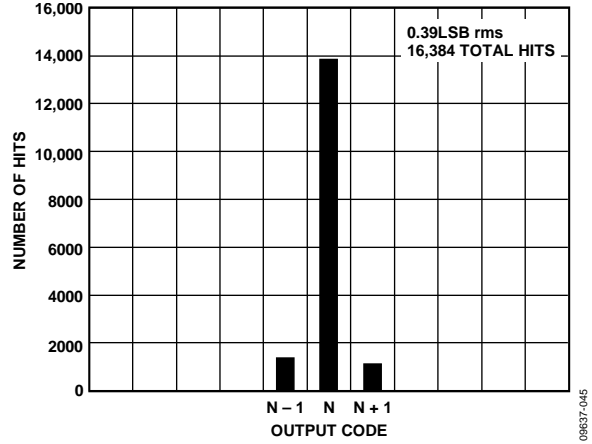

Figure 38. AD9613-250 Grounded Input Histogram

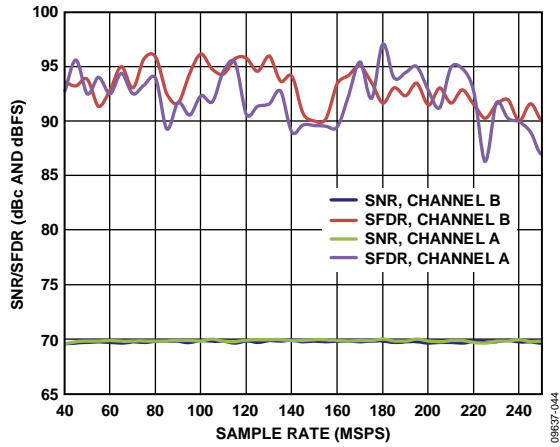

Figure 37. AD9613-250 Single-Tone SNR/SFDR vs. Sample Rate (f_s) with $f_{IN} = 90.1$ MHz

EQUIVALENT CIRCUITS

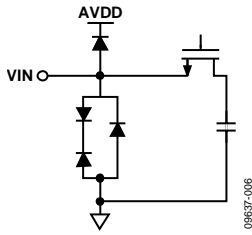

Figure 39. Equivalent Analog Input Circuit

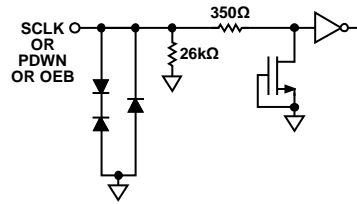

Figure 43. Equivalent SCLK, PDWN, or OEB Input Circuit

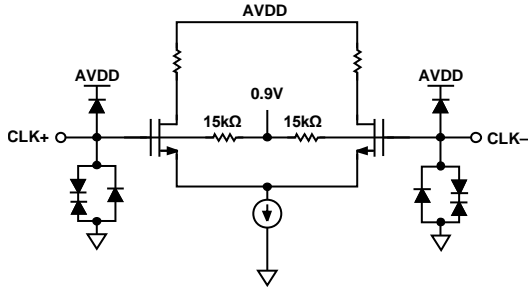

Figure 40. Equivalent Clock Input Circuit

09837-007

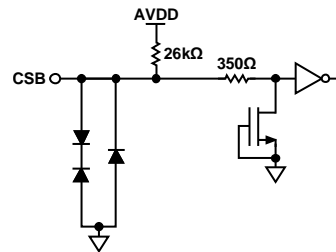

Figure 44. Equivalent CSB Input Circuit

09837-011

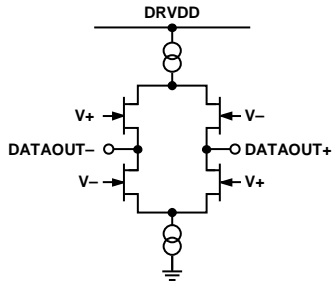

Figure 41. Equivalent LVDS Output Circuit

09837-063

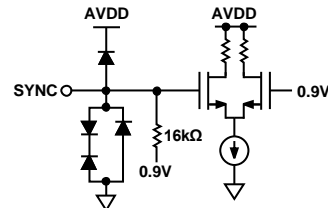

Figure 45. Equivalent SYNC Input Circuit

09837-012

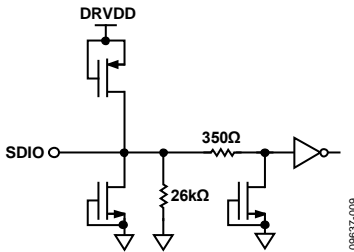

Figure 42. Equivalent SDIO Circuit

09837-009

THEORY OF OPERATION

The AD9613 has two analog input channels, two filter channels, and two digital output channels. The intermediate frequency (IF) input signal passes through several stages before appearing at the output port(s) as a filtered, and optionally, decimated digital signal.

The dual ADC design can be used for diversity reception of signals, where the ADCs operate identically on the same carrier but from two separate antennae. The ADCs can also be operated with independent analog inputs. The user can sample frequencies from dc to 300 MHz using appropriate low-pass or band-pass filtering at the ADC inputs with little loss in ADC performance. Operation to 400 MHz analog input is permitted but occurs at the expense of increased ADC noise and distortion.

Synchronization capability is provided to allow synchronized timing between multiple devices.

Programming and control of the AD9613 are accomplished using a 3-pin, SPI-compatible serial interface.

ADC ARCHITECTURE

The AD9613 architecture consists of a dual front-end sample-and-hold circuit, followed by a pipelined, switched-capacitor ADC. The quantized outputs from each stage are combined into a final 12-bit result in the digital correction logic. The pipelined architecture permits the first stage to operate on a new input sample and the remaining stages to operate on the preceding samples. Sampling occurs on the rising edge of the clock.

Each stage of the pipeline, excluding the last, consists of a low resolution flash ADC connected to a switched-capacitor digital-to-analog converter (DAC) and an interstage residue amplifier (MDAC). The MDAC magnifies the difference between the reconstructed DAC output and the flash input for the next stage in the pipeline. One bit of redundancy is used in each stage to facilitate digital correction of flash errors. The last stage simply consists of a flash ADC.

The input stage of each channel contains a differential sampling circuit that can be ac- or dc-coupled in differential or single-ended modes. The output staging block aligns the data, corrects errors, and passes the data to the output buffers. The output buffers are powered from a separate supply, allowing digital output noise to be separated from the analog core. During power-down, the output buffers go into a high impedance state.

ANALOG INPUT CONSIDERATIONS

The analog input to the AD9613 is a differential switched-capacitor circuit that has been designed for optimum performance while processing a differential input signal.

The clock signal alternatively switches the input between sample mode and hold mode (see the configuration shown in Figure 46). When the input is switched into sample mode, the signal source must be capable of charging the sampling capacitors and settling within 1/2 clock cycle.

A small resistor in series with each input can help reduce the peak transient current required from the output stage of the driving source. A shunt capacitor can be placed across the inputs to provide dynamic charging currents. This passive network creates a low-pass filter at the ADC input; therefore, the precise values are dependent on the application.

In intermediate frequency (IF) undersampling applications, the shunt capacitors should be reduced. In combination with the driving source impedance, the shunt capacitors limit the input bandwidth. Refer to the AN-742 Application Note, *Frequency Domain Response of Switched-Capacitor ADCs*; the AN-827 Application Note, *A Resonant Approach to Interfacing Amplifiers to Switched-Capacitor ADCs*; and the *Analog Dialogue* article, “[Transformer-Coupled Front-End for Wideband A/D Converters](#),” for more information on this subject.

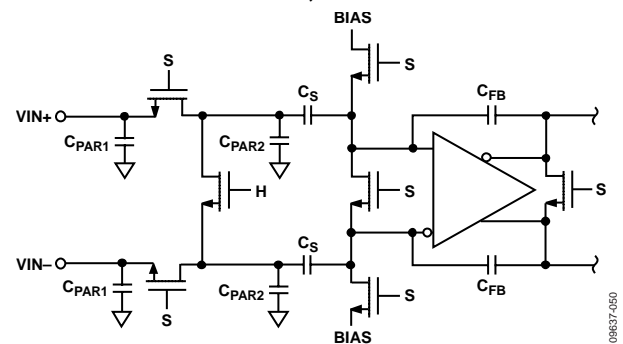

Figure 46. Switched-Capacitor Input

For best dynamic performance, the source impedances driving VIN+ and VIN- should be matched, and the inputs should be differentially balanced.

Input Common Mode

The analog inputs of the AD9613 are not internally dc biased. In ac-coupled applications, the user must provide this bias externally. Setting the device so that $V_{CM} = 0.5 \times AVDD$ (or 0.9 V) is recommended for optimum performance. An on-board common-mode voltage reference is included in the design and is available from the VCM pin. Using the VCM output to set the input common mode is recommended. Optimum performance is achieved when the common-mode voltage of the analog input is set by the VCM pin voltage (typically $0.5 \times AVDD$). The VCM pin must be decoupled to ground by a 0.1 μF capacitor, as described in the Applications Information section. Place this decoupling capacitor close to the pin to minimize the series resistance and inductance between the part and this capacitor.

Differential Input Configurations

Optimum performance is achieved while driving the AD9613 in a differential input configuration. For baseband applications, the AD8138, ADA4937-2, ADA4938-2, and ADA4930-2 differential drivers provide excellent performance and a flexible interface to the ADC.

The output common-mode voltage of the ADA4930-2 is easily set with the VCM pin of the AD9613 (see Figure 47), and the driver can be configured in a Sallen-Key filter topology to provide band limiting of the input signal.

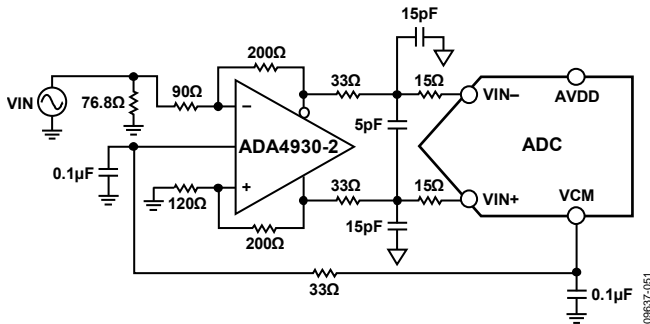

Figure 47. Differential Input Configuration Using the ADA4938-2

For baseband applications where SNR is a key parameter, differential transformer coupling is the recommended input configuration. An example is shown in Figure 48. To bias the analog input, the VCM voltage can be connected to the center tap of the secondary winding of the transformer.

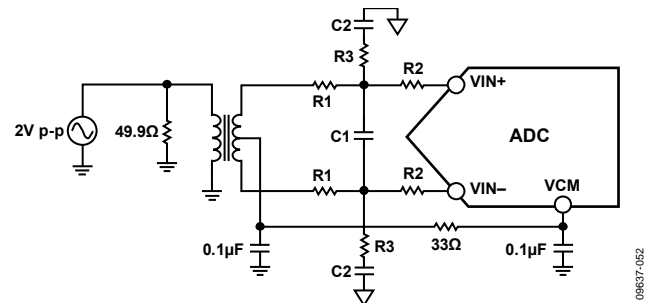

Figure 48. Differential Transformer-Coupled Configuration

Table 10. Example RC Network

Frequency Range (MHz)	R1 Series (Ω)	C1 Differential (pF)	R2 Series (Ω)	C2 Shunt (pF)	R3 Shunt (Ω)
0 to 100	33	8.2	0	15	49.9
100 to 300	15	3.9	0	8.2	49.9

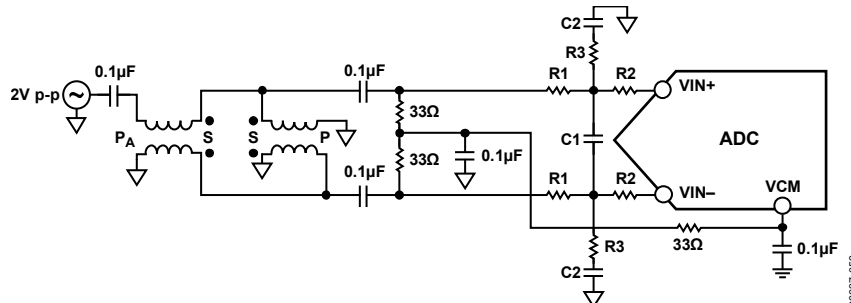

Figure 49. Differential Double Balun Input Configuration

The signal characteristics must be considered when selecting a transformer. Most RF transformers saturate at frequencies below a few megahertz. Excessive signal power can also cause core saturation, which leads to distortion.

At input frequencies in the second Nyquist zone and above, the noise performance of most amplifiers is not adequate to achieve the true SNR performance of the AD9613. For applications where SNR is a key parameter, differential double balun coupling is the recommended input configuration (see Figure 49). In this configuration, the input is ac-coupled, and the CML is provided to each input through a 33 Ω resistor. These resistors compensate for losses in the input baluns to provide a 50 Ω impedance to the driver.

In the double balun and transformer configurations, the value of the input capacitors and resistors is dependent on the input frequency and source impedance. Based on these parameters, the value of the input resistors and capacitors may need to be adjusted or some components may need to be removed. Table 10 displays recommended values to set the RC network for different input frequency ranges. However, these values are dependent on the input signal and bandwidth and should be used only as a starting guide. Note that the values given in Table 10 are for each R1, R2, C2, and R3 component shown in Figure 48 and Figure 49.

An alternative to using a transformer-coupled input at frequencies in the second Nyquist zone is to use an amplifier with variable gain. The AD8375 or AD8376 digital variable gain amplifier (DVGAs) provides good performance for driving the AD9613. Figure 50 shows an example of the AD8376 driving the AD9613 through a band-pass antialiasing filter.

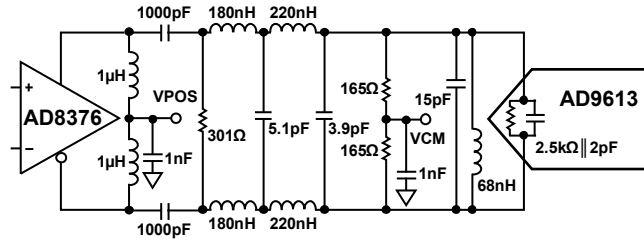

- NOTES
1. ALL INDUCTORS ARE COILCRAFT 0603CS COMPONENTS WITH THE EXCEPTION OF THE 1μH CHOKE INDUCTORS (0603LS).
 2. FILTER VALUES SHOWN FOR A 20MHz BANDWIDTH FILTER CENTERED AT 140MHz.

09637-054

Figure 50. Differential Input Configuration Using the AD8376 (Filter Values Shown for a 20 MHz Bandwidth Filter Centered at 140 MHz)

VOLTAGE REFERENCE

A stable and accurate voltage reference is built into the AD9613. The full-scale input range can be adjusted by varying the reference voltage via SPI. The input span of the ADC tracks reference voltage changes linearly.

CLOCK INPUT CONSIDERATIONS

For optimum performance, the AD9613 sample clock inputs, CLK+ and CLK-, should be clocked with a differential signal. The signal is typically ac-coupled into the CLK+ and CLK- pins via a transformer or via capacitors. These pins are biased internally (see Figure 51) and require no external bias. If the inputs are floated, the CLK- pin is pulled low to prevent spurious clocking.

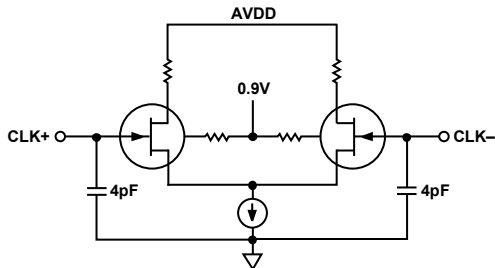

09637-055

Figure 51. Simplified Equivalent Clock Input Circuit

Clock Input Options

The AD9613 has a very flexible clock input structure. Clock input can be a CMOS, LVDS, LVPECL, or sine wave signal. Regardless of the type of signal being used, clock source jitter is of the most concern, as described in the Jitter Considerations section.

Figure 52 and Figure 53 show two preferable methods for clocking the AD9613 (at clock rates of up to 625 MHz). A low jitter clock source is converted from a single-ended signal to a differential signal using an RF balun or RF transformer.

The RF balun configuration is recommended for clock frequencies between 125 MHz and 625 MHz, and the RF transformer is recommended for clock frequencies from 10 MHz to 200 MHz. The back-to-back Schottky diodes across the transformer secondary limit clock excursions into the AD9613 to approximately 0.8 V p-p differential. This limit helps prevent the large voltage swings of

the clock from feeding through to other portions of the AD9613, while preserving the fast rise and fall times of the signal, which are critical to low jitter performance.

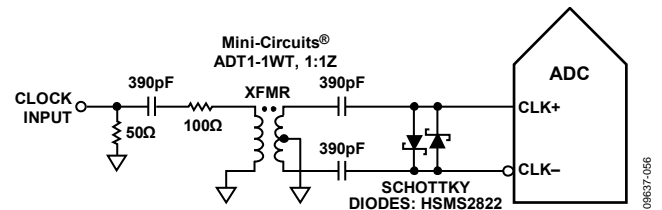

09637-056

Figure 52. Transformer Coupled Differential Clock (Up to 200 MHz)

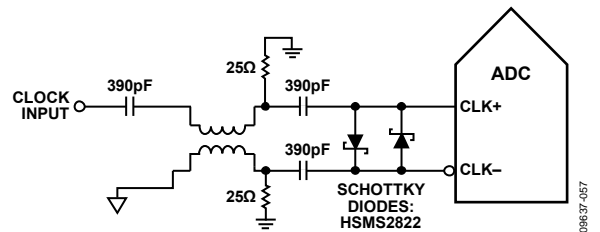

09637-057

Figure 53. Balun-Coupled Differential Clock (Up to 625 MHz)

If a low jitter clock source is not available, another option is to ac-couple a differential PECL signal to the sample clock input pins, as shown in Figure 54. The AD9510, AD9511, AD9512, AD9513, AD9514, AD9515, AD9516, AD9517, AD9518, AD9520, AD9522, AD9523, AD9524, and ADCLK905/ADCLK907/ADCLK925 clock drivers offer excellent jitter performance.

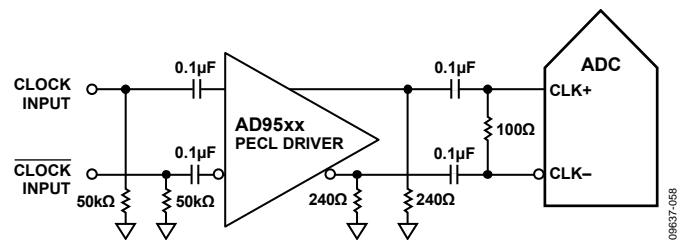

09637-058

Figure 54. Differential PECL Sample Clock (Up to 625 MHz)

A third option is to ac-couple a differential LVDS signal to the sample clock input pins, as shown in Figure 55. The AD9510, AD9511, AD9512, AD9513, AD9514, AD9515, AD9516, AD9517, AD9518, AD9520, AD9522, AD9523, and AD9524 clock drivers offer excellent jitter performance.

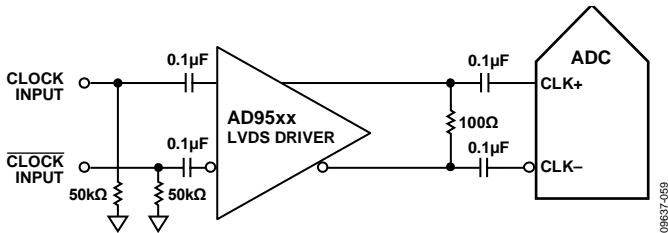

Figure 55. Differential LVDS Sample Clock (Up to 625 MHz)

Input Clock Divider

The AD9613 contains an input clock divider with the ability to divide the input clock by integer values between 1 and 8. The duty cycle stabilizer (DCS) is enabled by default on power-up.

The AD9613 clock divider can be synchronized using the external SYNC input. Bit 1 and Bit 2 of Register 0x3A allow the clock divider to be resynchronized on every SYNC signal or only on the first SYNC signal after the register is written. A valid SYNC causes the clock divider to reset to its initial state. This synchronization feature allows multiple parts to have their clock dividers aligned to guarantee simultaneous input sampling.

Clock Duty Cycle

Typical high speed ADCs use both clock edges to generate a variety of internal timing signals and, as a result, may be sensitive to clock duty cycle. Commonly, a $\pm 5\%$ tolerance is required on the clock duty cycle to maintain dynamic performance characteristics.

The AD9613 contains a duty-cycle stabilizer (DCS) that retimes the nonsampling (falling) edge, providing an internal clock signal with a nominal 50% duty cycle. This allows the user to provide a wide range of clock input duty cycles without affecting the performance of the AD9613.

Jitter on the rising edge of the input clock is still of paramount concern and is not reduced by the duty cycle stabilizer. The duty cycle control loop does not function for clock rates less than 40 MHz nominally. The loop has a time constant associated with it that must be considered when the clock rate can change dynamically. A wait time of 1.5 μs to 5 μs is required after a dynamic clock frequency increase or decrease before the DCS loop is relocked to the input signal. During the period that the loop is not locked, the DCS loop is bypassed, and internal device timing is dependent on the duty cycle of the input clock signal. In such applications, it may be appropriate to disable the duty cycle stabilizer. In all other applications, enabling the DCS circuit is recommended to maximize ac performance.

Jitter Considerations

High speed, high resolution ADCs are sensitive to the quality of the clock input. The degradation in SNR at a given input frequency (f_{IN}) due to jitter (t_j) can be calculated by

$$SNR_{HF} = -10 \log[(2\pi \times f_{IN} \times t_{jRMS})^2 + 10^{(-SNR_{LF}/10)}]$$

In the equation, the rms aperture jitter represents the root-mean-square of all jitter sources, which include the clock input, the analog input signal, and the ADC aperture jitter specification. IF undersampling applications are particularly sensitive to jitter, as shown in Figure 56.

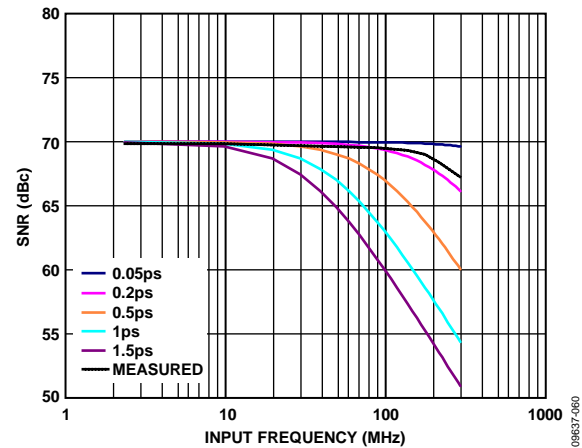

Figure 56. AD9613-250 SNR vs. Input Frequency and Jitter

The clock input should be treated as an analog signal in cases where aperture jitter may affect the dynamic range of the AD9613. Power supplies for clock drivers should be separated from the ADC output driver supplies to avoid modulating the clock signal with digital noise. Low jitter, crystal-controlled oscillators make the best clock sources. If the clock is generated from another type of source (by gating, dividing, or another method), it should be retimed by the original clock at the last step.

Refer to the AN-501 Application Note, *Aperture Uncertainty and ADC System Performance*, and the AN-756 Application Note, *Sample Systems and the Effects of Clock Phase Noise and Jitter*, for more information about jitter performance as it relates to ADCs.

POWER DISSIPATION AND STANDBY MODE

As shown in Figure 57, the power dissipated by the AD9613 is proportional to its sample rate. The data in Figure 57 was taken using the same operating conditions as those used for the Typical Performance Characteristics section.

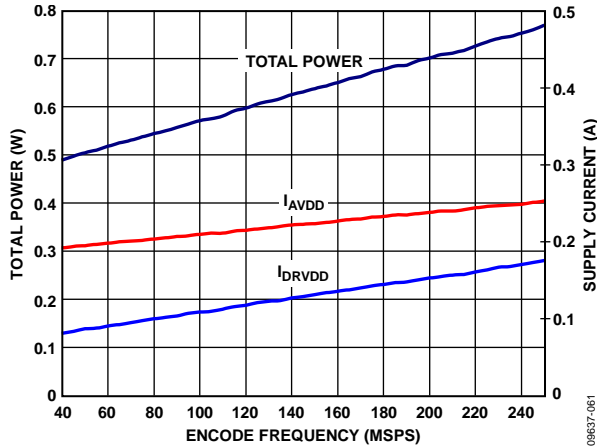

Figure 57. AD9613-250 Power and Current vs. Sample Rate

By asserting PDWN (either through the SPI port or by asserting the PDWN pin high), the AD9613 is placed in power-down mode. In this state, the ADC typically dissipates 10 mW. During power-down, the output drivers are placed in a high impedance state. Asserting the PDWN pin low returns the AD9613 to its normal operating mode. Note that PDWN is referenced to the digital output driver supply (DRVDD) and should not exceed that supply voltage.

Low power dissipation in power-down mode is achieved by shutting down the reference, reference buffer, biasing networks, and clock. Internal capacitors are discharged when entering power-down mode and then must be recharged when returning to normal operation. As a result, wake-up time is related to the time spent in power-down mode, and shorter power-down cycles result in proportionally shorter wake-up times.

When using the SPI port interface, the user can place the ADC in power-down mode or standby mode. Standby mode allows the user to keep the internal reference circuitry powered when faster wake-up times are required. See the Memory Map Register Description section and the AN-877 Application Note, *Interfacing to High Speed ADCs via SPI*, for additional details.

DIGITAL OUTPUTS

The AD9613 output drivers can be configured for either ANSI LVDS or reduced drive LVDS using a 1.8 V DRVDD supply.

As detailed in Application Note AN-877, *Interfacing to High Speed ADCs via SPI*, the data format can be selected for offset binary, twos complement, or gray code when using the SPI control.

Digital Output Enable Function (OEB)

The AD9613 has a flexible three-state ability for the digital output pins. The three-state mode is enabled using the OEB pin or through the SPI interface. If the OEB pin is low, the output data drivers are enabled. If the OEB pin is high, the output data drivers are placed in a high impedance state. This OEB function is not intended for rapid access to the data bus. Note that OEB is referenced to the digital output driver supply (DRVDD) and should not exceed that supply voltage.

When using the SPI interface, the data outputs of each channel can be independently three-stated by using the output enable bar bit (Bit 4) in Register 0x14. Because the output data is interleaved, if only one of the two channels is disabled, the output data of the remaining channel is repeated in both the rising and falling output clock cycles.

Timing

The AD9613 provides latched data with a pipeline delay of 10 input sample clock cycles. Data outputs are available one propagation delay (t_{PD}) after the rising edge of the clock signal.

Minimize the length of the output data lines and loads placed on them to reduce transients within the AD9613. These transients can degrade converter dynamic performance.

The lowest typical conversion rate of the AD9613 is 40 MSPS. At clock rates below 40 MSPS, dynamic performance can degrade.

Data Clock Output (DCO)

The AD9613 also provides data clock output (DCO) intended for capturing the data in an external register. Figure 2 shows a timing diagram of the AD9613 output modes.

ADC OVERRANGE (OR)

The ADC overrange indicator is asserted when an overrange is detected on the input of the ADC. The overrange condition is determined at the output of the ADC pipeline and, therefore, is subject to a latency of 10 ADC clock. An overrange at the input is indicated by this bit 10 clock cycles after it.

Table 11. Output Data Format

Input (V)	VIN+ – VIN–, Input Span = 1.75 V p-p (V)	Offset Binary Output Mode	Twos Complement Mode (Default)	OR
VIN+ – VIN–	Less than –0.875	0000 0000 0000	1000 0000 0000	1
VIN+ – VIN–	–0.875	0000 0000 0000	1000 0000 0000	0
VIN+ – VIN–	0	1000 0000 0000	0000 0000 0000	0
VIN+ – VIN–	+0.875	1111 1111 1111	0111 1111 1111	0
VIN+ – VIN–	Greater than +0.875	1111 1111 1111	0111 1111 1111	1

CHANNEL/CHIP SYNCHRONIZATION

The AD9613 has a SYNC input that allows the user flexible synchronization options for synchronizing the internal blocks. The sync feature is useful for guaranteeing synchronized operation across multiple ADCs. The input clock divider can be synchronized using the SYNC input. The divider can be enabled to synchronize on a single occurrence of the SYNC signal or on every occurrence by setting the appropriate bits in Register 0x3A.

The SYNC input is internally synchronized to the sample clock. However, to ensure that there is no timing uncertainty between multiple parts, the SYNC input signal should be synchronized to the input clock signal. The SYNC input should be driven using a single-ended CMOS type signal.

SERIAL PORT INTERFACE (SPI)

The AD9613 SPI allows the user to configure the converter for specific functions or operations through a structured register space provided inside the ADC. The SPI gives the user added flexibility and customization, depending on the application.

Addresses are accessed via the serial port and can be written to or read from via the port. Memory is organized into bytes that can be further divided into fields. These fields are documented in the Memory Map section. For detailed operational information, see the AN-877 Application Note, *Interfacing to High Speed ADCs via SPI*.

CONFIGURATION USING THE SPI

Three pins define the SPI of this ADC: the SCLK pin, the SDIO pin, and the CSB pin (see Table 12). The SCLK (serial clock) pin is used to synchronize the read and write data presented from/to the ADC. The SDIO (serial data input/output) pin is a dual-purpose pin that allows data to be sent and read from the internal ADC memory map registers. The CSB (chip select bar) pin is an active-low control that enables or disables the read and write cycles.

Table 12. Serial Port Interface Pins

Pin	Function
SCLK	Serial Clock. The serial shift clock input, which is used to synchronize serial interface reads and writes.
SDIO	Serial Data Input/Output. A dual-purpose pin that typically serves as an input or an output, depending on the instruction being sent and the relative position in the timing frame.
CSB	Chip Select Bar. An active-low control that gates the read and write cycles.

The falling edge of CSB, in conjunction with the rising edge of SCLK, determines the start of the framing. An example of the serial timing and its definitions can be found in Figure 58 and Table 5.

Other modes involving the CSB are available. The CSB can be held low indefinitely, which permanently enables the device; this is called streaming. The CSB can stall high between bytes to allow for additional external timing. When CSB is tied high, SPI functions are placed in a high impedance mode. This mode turns on any SPI pin secondary functions.

During an instruction phase, a 16-bit instruction is transmitted. Data follows the instruction phase and its length is determined by the W0 and W1 bits.

All data is composed of 8-bit words. The first bit of each individual byte of serial data indicates whether a read or write command is issued. This allows the serial data input/output (SDIO) pin to change direction from an input to an output.

In addition to word length, the instruction phase determines whether the serial frame is a read or write operation, allowing the serial port to be used both to program the chip and to read the contents of the on-chip memory. If the instruction is a readback operation, performing a readback causes the serial data input/output (SDIO) pin to change direction from an input to an output at the appropriate point in the serial frame.

Data can be sent in MSB-first mode or in LSB-first mode. MSB first is the default on power-up and can be changed via the SPI port configuration register. For more information about this and other features, see the AN-877 Application Note, *Interfacing to High Speed ADCs via SPI*.

HARDWARE INTERFACE

The pins described in Table 12 comprise the physical interface between the user programming device and the serial port of the AD9613. The SCLK pin and the CSB pin function as inputs when using the SPI interface. The SDIO pin is bidirectional, functioning as an input during write phases and as an output during readback.

The SPI interface is flexible enough to be controlled by either FPGAs or microcontrollers. One method for SPI configuration is described in detail in the AN-812 Application Note, *Microcontroller-Based Serial Port Interface (SPI) Boot Circuit*.

The SPI port should not be active during periods when the full dynamic performance of the converter is required. Because the SCLK signal, the CSB signal, and the SDIO signal are typically asynchronous to the ADC clock, noise from these signals can degrade converter performance. If the on-board SPI bus is used for other devices, it may be necessary to provide buffers between this bus and the AD9613 to prevent these signals from transitioning at the converter inputs during critical sampling periods.

SPI ACCESSIBLE FEATURES

Table 13 provides a brief description of the general features that are accessible via the SPI. These features are described in detail in the [AN-877](#) Application Note, *Interfacing to High Speed ADCs via SPI*. The AD9613 part-specific features are described in the Memory Map Register Description section.

Table 13. Features Accessible Using the SPI

Feature Name	Description
Mode	Allows the user to set either power-down mode or standby mode
Clock	Allows the user to access the DCS via the SPI
Offset	Allows the user to digitally adjust the converter offset
Test I/O	Allows the user to set test modes to have known data on output bits
Output Mode	Allows the user to set up outputs
Output Phase	Allows the user to set the output clock polarity
Output Delay	Allows the user to vary the DCO delay
VREF	Allows the user to set the reference voltage
Digital Processing	Allows the user to enable the synchronization features

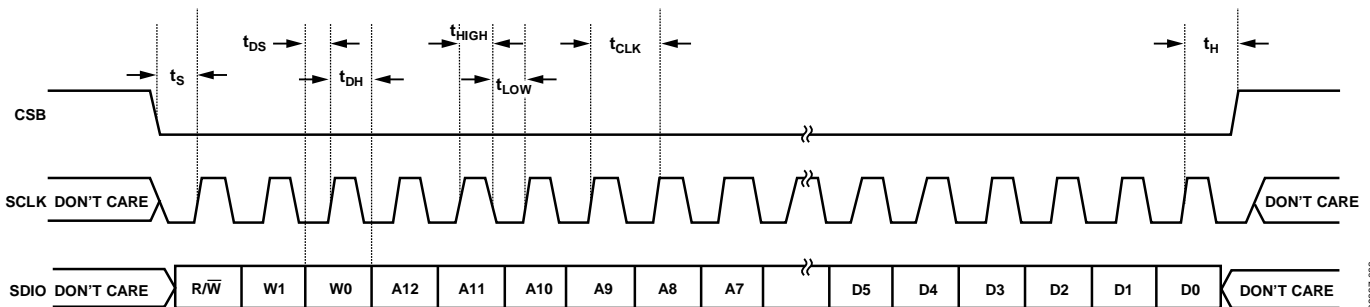

Figure 58. Serial Port Interface Timing Diagram

08837-082

MEMORY MAP

READING THE MEMORY MAP REGISTER TABLE

Each row in the memory map register table has eight bit locations. The memory map is roughly divided into four sections: the chip configuration registers (Address 0x00 to Address 0x02); the channel index and transfer registers (Address 0x05 and Address 0xFF); and the ADC functions registers, including setup, control, and test (Address 0x08 to Address 0x3A).

The memory map register table (see Table 14) documents the default hexadecimal value for each hexadecimal address shown. The column with the heading Bit 7 (MSB) is the start of the default hexadecimal value given. For example, Address 0x14, the output mode register, has a hexadecimal default value of 0x05. This means that Bit 0 = 1 and Bit 2 = 1, and the remaining bits are 0s. This setting is the default output format value, which is twos complement. For more information on this function and others, see the [AN-877](#) Application Note, *Interfacing to High Speed ADCs via SPI*. This document details the functions controlled by Register 0x00 to Register 0x20. The remaining register, Register 0x3A, is documented in the Memory Map Register Description section.

Open and Reserved Locations

All address and bit locations that are not included in Table 14 are not currently supported for this device. Unused bits of a valid address location should be written with 0s. Writing to these locations is required only when part of an address location is open (for example, Address 0x18). If the entire address location is open (for example, Address 0x13), this address location should not be written.

Default Values

After the [AD9613](#) is reset, critical registers are loaded with default values. The default values for the registers are given in the memory map register table (see Table 14).

Logic Levels

An explanation of logic level terminology follows:

- “Bit is set” is synonymous with “bit is set to Logic 1” or “writing Logic 1 for the bit.”
- “Clear a bit” is synonymous with “bit is set to Logic 0” or “writing Logic 0 for the bit.”

Transfer Register Map

Address 0x08 to Address 0x20 and Address 0x3A are shadowed. Writes to these addresses do not affect part operation until a transfer command is issued by writing 0x01 to Address 0xFF, setting the transfer bit. This allows these registers to be updated internally and simultaneously when the transfer bit is set. The internal update takes place when the transfer bit is set and the bit aut clears.

Channel Specific Registers

Some channel setup functions, such as the signal monitor thresholds, can be programmed to a different value for each channel. In these cases, channel address locations are internally duplicated for each channel. These registers and bits are designated in Table 14 as local. These local registers and bits can be accessed by setting the appropriate Channel A or Channel B bits in Register 0x05. If both bits are set, the subsequent write affects the registers of both channels. In a read cycle, only Channel A or Channel B should be set to read one of the two registers. If both bits are set during an SPI read cycle, the part returns the value for Channel A. Registers and bits designated as global in Table 14 affect the entire part and the channel features for which independent settings are not allowed between channels. The settings in Register 0x05 do not affect the global registers and bits.

MEMORY MAP REGISTER TABLE

All address and bit locations that are not included in Table 14 are not currently supported for this device.

Table 14. Memory Map Registers

Addr (Hex)	Register Name	Bit 7 (MSB)	Bit 6	Bit 5	Bit 4	Bit 3	Bit 2	Bit 1	Bit 0 (LSB)	Default Value (Hex)	Default Notes/ Comments
Chip Configuration Registers											
0x00	SPI port configuration (global) ¹	0	LSB first	Soft reset	1	1	Soft reset	LSB first	0	0x18	The nibbles are mirrored so that LSB-first mode or MSB-first mode registers correctly, regardless of shift mode
0x01	Chip ID (global)	8-bit chip ID[7:0] (AD9613 = 0x83) (default)								0x83	Read only
0x02	Chip grade (global)	Open	Open	Speed grade ID 00 = 250 MSPS 01 = 210 MSPS 11 = 170 MSPS	Open	Open	Open	Open	Open		Speed grade ID used to differentiate devices; read only
Channel Index and Transfer Registers											
0x05	Channel index (global)	Open	Open	Open	Open	Open	Open	ADC B (default)	ADC A (default)	0x03	Bits are set to determine which device on the chip receives the next write command; applies to local registers only
0xFF	Transfer (global)	Open	Open	Open	Open	Open	Open	Open	Transfer	0x00	Synchronously transfers data from the master shift register to the slave
ADC Functions											
0x08	Power modes (local)	Open	Open	External power-down pin function (local) 0 = power-down 1 = standby	Open	Open	Open	Internal power-down mode (local) 00 = normal operation 01 = full power-down 10 = standby 11 = reserved		0x00	Determines various generic modes of chip operation
0x09	Global clock (global)	Open	Open	Open	Open	Open	Open	Open	Duty cycle stabilizer (default)	0x01	
0x0B	Clock divide (global)	Open	Open	Input clock divider phase adjust 000 = no delay 001 = 1 input clock cycle 010 = 2 input clock cycles 011 = 3 input clock cycles 100 = 4 input clock cycles 101 = 5 input clock cycles 110 = 6 input clock cycles 111 = 7 input clock cycles			Clock divide ratio 000 = divide by 1 001 = divide by 2 010 = divide by 3 011 = divide by 4 100 = divide by 5 101 = divide by 6 110 = divide by 7 111 = divide by 8		0x00	Clock divide values other than 000 automatically cause the duty cycle stabilizer to become active	

Addr (Hex)	Register Name	Bit 7 (MSB)	Bit 6	Bit 5	Bit 4	Bit 3	Bit 2	Bit 1	Bit 0 (LSB)	Default Value (Hex)	Default Notes/Comments
0x0D	Test mode (local)	User test mode control 0 = continuous/repeat pattern 1 = single pattern, then 0s	Open	Reset PN long gen	Reset PN short gen	Output test mode 0000 = off (default) 0001 = midscale short 0010 = positive FS 0011 = negative FS 0100 = alternating checkerboard 0101 = PN long sequence 0110 = PN short sequence 0111 = one/zero word toggle 1000 = user test mode 1001 to 1110 = unused 1111 = ramp output				0x00	When this register is set, the test data is placed on the output pins in place of normal data
0x10	Offset adjust (local)	Open	Open	Offset adjust in LSBs from +31 to -32 (twos complement format)						0x00	
0x14	Output mode	Open	Open	Open	Output enable bar (local)	Open	Output invert (local) 1 = normal (default) 0 = inverted	Output format 00 = offset binary 01 = twos complement (default) 10 = gray code 11 = reserved (local)		0x05	Configures the outputs and the format of the data
0x15	Output Adjust (Global)	Open	Open	Open	Open	LVDS output drive current adjust 0000 = 3.72 mA output drive current 0001 = 3.5 mA output drive current (default) 0010 = 3.30 mA output drive current 0011 = 2.96 mA output drive current 0100 = 2.82 mA output drive current 0101 = 2.57 mA output drive current 0110 = 2.27 mA output drive current 0111 = 2.0 mA output drive current (reduced range) 1000 - 1111 = reserved				0x01	
0x16	Clock phase control (global)	Invert DCO clock	Open	Odd/Even Mode Output Enable 0 = disabled 1 = enabled	Open	Open	Open	Open	Open	0x00	
0x17	DCO output delay (global)	Enable DCO clock delay	Open	Open	DCO clock delay [delay = (3100 ps × register value/31 + 100)] 00000 = 100 ps 00001 = 200 ps 00010 = 300 ps ... 11110 = 3100 ps 11111 = 3200 ps				0x00		
0x18	Input span select (global)	Open	Open	Open	Full-scale input voltage selection 01111 = 2.087 V p-p ... 00001 = 1.772 V p-p 00000 = 1.75 V p-p (default) 11111 = 1.727 V p-p ... 10000 = 1.383 V p-p				0x00	Full-scale input adjustment in 0.022 V steps	
0x19	User Test Pattern 1 LSB (global)	User Test Pattern 1[7:0]								0x00	
0x1A	User Test Pattern 1 MSB (global)	User Test Pattern 1[15:8]								0x00	
0x1B	User Test Pattern 2 LSB (global)	User Test Pattern 2[7:0]								0x00	
0x1C	User Test Pattern 2 MSB (global)	User Test Pattern 2[15:8]								0x00	
0x1D	User Test Pattern 3 LSB (global)	User Test Pattern 3[7:0]								0x00	

Addr (Hex)	Register Name	Bit 7 (MSB)	Bit 6	Bit 5	Bit 4	Bit 3	Bit 2	Bit 1	Bit 0 (LSB)	Default Value (Hex)	Default Notes/Comments
0x1E	User Test Pattern 3 MSB (global)	User Test Pattern 3[15:8]								0x00	
0x1F	User Test Pattern 4 LSB (global)	User Test Pattern 4[7:0]								0x00	
0x3A	Sync control (global)	Open	Open	Open	Open	Open	Clock divider next sync only	Clock divider sync enable	Master sync buffer enable	0x00	

¹ The channel index register at Address 0x05 should be set to 0x03 (default) when writing to Address 0x00.

MEMORY MAP REGISTER DESCRIPTION

For more information on functions controlled in Register 0x00 to Register 0x20, see the [AN-877](#) Application Note, *Interfacing to High Speed ADCs via SPI*.

Sync Control (Register 0x3A)

Bits[7:3]—Reserved

Bit 2—Clock Divider Next Sync Only

If the master sync buffer enable bit (Address 0x3A, Bit 0) and the clock divider sync enable bit (Address 0x3A, Bit 1) are high, Bit 2 allows the clock divider to sync to the first sync pulse that

it receives and to ignore the rest. The clock divider sync enable bit (Address 0x3A, Bit 1) resets after it syncs.

Bit 1—Clock Divider Sync Enable

Bit 1 gates the sync pulse to the clock divider. The sync signal is enabled when Bit 1 is high and Bit 0 is high. This is continuous sync mode.

Bit 0—Master Sync Buffer Enable

Bit 0 must be set high to enable any of the sync functions. If the sync capability is not used, this bit should remain low to conserve power.

APPLICATIONS INFORMATION

DESIGN GUIDELINES

Before starting system-level design and layout of the [AD9613](#), it is recommended that the designer become familiar with these guidelines, which discuss the special circuit connections and layout requirements needed for certain pins.

Power and Ground Recommendations

When connecting power to the [AD9613](#), it is recommended that two separate 1.8 V supplies be used: one supply should be used for analog (AVDD), and a separate supply should be used for the digital outputs (DRVDD). The designer can employ several different decoupling capacitors to cover both high and low frequencies. These capacitors should be located close to the point of entry at the PC board level and close to the pins of the part with minimal trace length.

A single PCB ground plane should be sufficient when using the [AD9613](#). With proper decoupling and smart partitioning of the PCB analog, digital, and clock sections, optimum performance is easily achieved.

Exposed Paddle Thermal Heat Slug Recommendations

It is mandatory that the exposed paddle on the underside of the ADC be connected to analog ground (AGND) to achieve the best electrical and thermal performance. A continuous, exposed (no solder mask) copper plane on the PCB should mate to the [AD9613](#) exposed paddle, Pin 0.

The copper plane should have several vias to achieve the lowest possible resistive thermal path for heat dissipation to flow through the bottom of the PCB. These vias should be filled or plugged with nonconductive epoxy.

To maximize the coverage and adhesion between the ADC and the PCB, a silkscreen should be overlaid to partition the continuous plane on the PCB into several uniform sections. This provides several tie points between the ADC and the PCB during the reflow process. Using one continuous plane with no partitions guarantees only one tie point between the ADC and the PCB. See the evaluation board for a PCB layout example. For detailed information about the packaging and PCB layout of chip-scale packages, refer to the AN-772 Application Note, *A Design and Manufacturing Guide for the Lead Frame Chip Scale Package (LFCSP)*.

VCM

The VCM pin should be decoupled to ground with a 0.1 μF capacitor, as shown in Figure 48. For optimal channel-to-channel isolation, a 33 Ω resistor should be included between the [AD9613](#) VCM pin and the Channel A analog input network connection, as well as between the [AD9613](#) VCM pin and the Channel B analog input network connection.

SPI Port

The SPI port should not be active during periods when the full dynamic performance of the converter is required. Because the SCLK, CSB, and SDIO signals are typically asynchronous to the ADC clock, noise from these signals can degrade converter performance. If the on-board SPI bus is used for other devices, it may be necessary to provide buffers between this bus and the [AD9613](#) to keep these signals from transitioning at the converter input pins during critical sampling periods.

OUTLINE DIMENSIONS

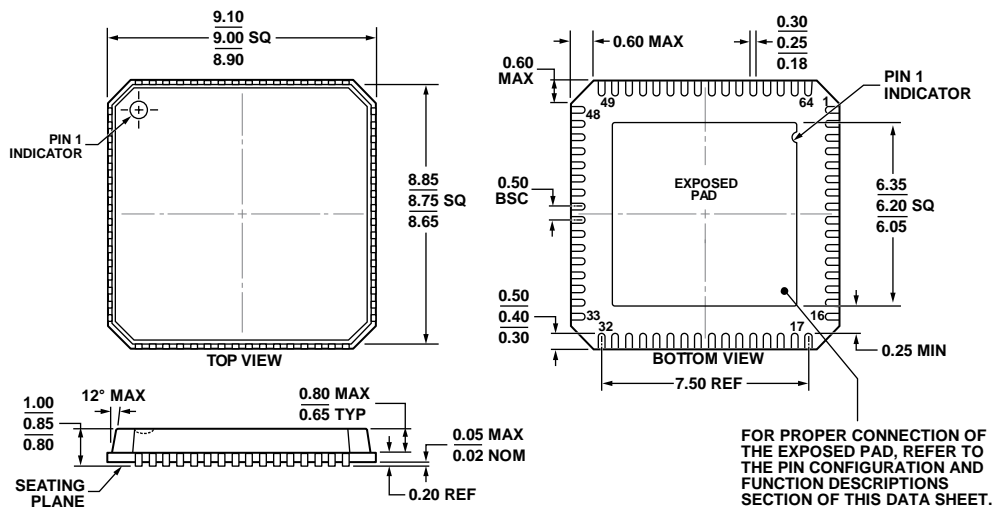

COMPLIANT TO JEDEC STANDARDS MO-220-VMM4

Figure 59. 64-Lead Lead Frame Chip Scale Package [LFCSP_VQ]
 9 mm × 9 mm Body, Very Thin Quad
 (CP-64-4)
 Dimensions shown in millimeters

06-12-2012-C

ORDERING GUIDE

Model ¹	Temperature Range	Package Description	Package Option
AD9613BCPZ-170	-40°C to +85°C	64-Lead Lead Frame Chip Scale Package [LFCSP_VQ], 170 MSPS	CP-64-4
AD9613BCPZ-210	-40°C to +85°C	64-Lead Lead Frame Chip Scale Package [LFCSP_VQ], 210 MSPS	CP-64-4
AD9613BCPZ-250	-40°C to +85°C	64-Lead Lead Frame Chip Scale Package [LFCSP_VQ], 250 MSPS	CP-64-4
AD9613BCPZRL7-170	-40°C to +85°C	64-Lead Lead Frame Chip Scale Package [LFCSP_VQ], 170 MSPS	CP-64-4
AD9613BCPZRL7-210	-40°C to +85°C	64-Lead Lead Frame Chip Scale Package [LFCSP_VQ], 210 MSPS	CP-64-4
AD9613BCPZRL7-250	-40°C to +85°C	64-Lead Lead Frame Chip Scale Package [LFCSP_VQ], 250 MSPS	CP-64-4
AD9613-170EBZ		Evaluation Board with AD9613, 170 MSPS	
AD9613-210EBZ		Evaluation Board with AD9613, 210 MSPS	
AD9613-250EBZ		Evaluation Board with AD9613, 250 MSPS	

¹ Z = RoHS Compliant Part.

Looking for pricing, stock, or lifecycle information?

Click below to explore more details on WIN SOURCE:

 [View AD9613BCPZ-170 on WIN SOURCE](#)

 [Analog Devices Inc. Information](#)

Optimize Your Supply Chain with WIN SOURCE Solutions

-  Global Sourcing Solution
-  Obsolete Management
-  Cost Control Management
-  Shortage Management
-  Alternative Solution
-  Excess Inventory Management